



OUR GLOBAL
COMPETENCE
CENTRES

 APOLLO DISPLAY
TECHNOLOGIES



 DISTEC



 DISPLAY
TECHNOLOGY



Manual

iBASE

ET977

**Industrial COM Express® Basic Type 6 Computer-on-Module with
AMD Ryzen® V1000 / R1000 Embedded Processor**

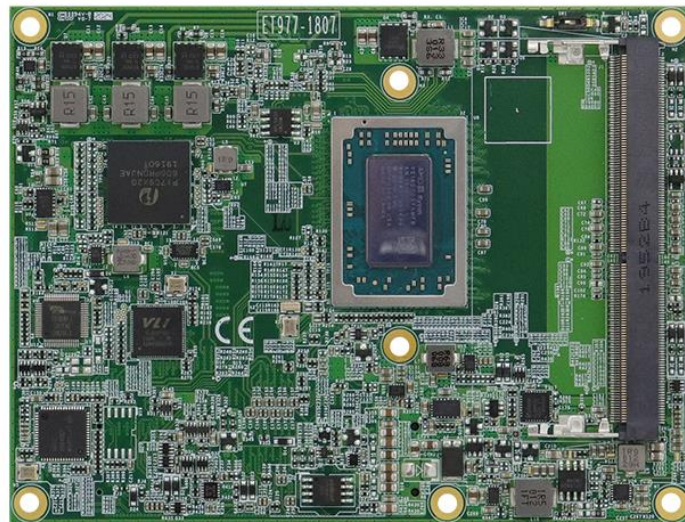

The information contained in this document has been carefully researched and is, to the best of our knowledge, accurate. However, we assume no liability for any product failures or damages, immediate or consequential, resulting from the use of the information provided herein. Our products are not intended for use in systems in which failures of product could result in personal injury. All trademarks mentioned herein are property of their respective owners. All specifications are subject to change without notice.

ET977

**AMD Ryzen™ Embedded
V1000/R1000
COM Express Type 6 Module**

User's Manual

Version 1.0

Copyright

© 2020 IBASE Technology, Inc. All rights reserved.

No part of this publication may be reproduced, copied, stored in a retrieval system, translated into any language or transmitted in any form or by any means, electronic, mechanical, photocopying, or otherwise, without the prior written consent of IBASE Technology, Inc. (hereinafter referred to as “IBASE”).

Disclaimer

IBASE reserves the right to make changes and improvements to the products described in this document without prior notice. Every effort has been made to ensure the information in the document is correct; however, IBASE does not guarantee this document is error-free.

IBASE assumes no liability for incidental or consequential damages arising from misapplication or inability to use the product or the information contained herein, nor for any infringements of rights of third parties, which may result from its use.

Trademarks

All the trademarks, registrations and brands mentioned herein are used for identification purposes only and may be trademarks and/or registered trademarks of their respective owners.

Compliance



This product has passed CE tests for environmental specifications and limits and deemed to meet EU safety, health and environmental protection requirements



This product has been tested and found to comply with the limits for a Class B device, pursuant to Part 15 of the FCC Rules. These limits are designed to provide reasonable protection against harmful interference in a residential installation. This equipment generates, uses and can radiate radio frequency energy and, if not installed and used in accordance with manufacturer's instructions, may cause harmful interference to radio communications.

WEEE



This product must not be disposed of as normal household waste, in accordance with the EU directive of for waste electrical and electronic equipment (WEEE - 2012/19/EU). Instead, it should be disposed of by returning it to a municipal recycling collection point. Check local regulations for disposal of electronic products.

Green IBASE



This product is compliant with the current RoHS restrictions and prohibits use of the following substances in concentrations exceeding 0.1% by weight (1000 ppm) except for cadmium, limited to 0.01% by weight (100 ppm).

- Lead (Pb)
- Mercury (Hg)
- Cadmium (Cd)
- Hexavalent chromium (Cr6+)
- Polybrominated biphenyls (PBB)
- Polybrominated diphenyl ether (PBDE)

Important Safety Information

Carefully read the precautions before using the board.

Environmental conditions:

- Use this product in environments with ambient temperatures between 0°C and 60°C.
- Do not leave this product in an environment where the storage temperature may be below -20° C or above 80° C.

Care for your iBASE products:

- Before cleaning the PCB, unplug all cables and remove the battery.
- Clean the PCB with a circuit board cleaner or degreaser, or use cotton swabs and alcohol.



WARNING

Attention during use:

- Do not use this product near water.
- Do not spill water or any other liquids on this product.
- Do not place heavy objects on the top of this product.

Anti-static precautions

- Wear an anti-static wrist strap to avoid electrostatic discharge.
- Place the PCB on an anti-static kit or mat.
- Ground yourself by touching a grounded conductor or a grounded bit of metal frequently to discharge any static.



CAUTION

Danger of explosion if the internal lithium-ion battery is replaced by an incorrect type. Replace only with the same or equivalent type recommended by the manufacturer. Dispose of used batteries according to the manufacturer's instructions or recycle them at a local recycling facility or battery collection point.

Warranty Policy

- **IBASE standard products:**

24-month (2-year) warranty from the date of shipment. If the date of shipment cannot be ascertained, the product serial numbers can be used to determine the approximate shipping date.

- **3rd-party parts:**

12-month (1-year) warranty from delivery for the 3rd-party parts that are not manufactured by IBASE, such as CPU, CPU cooler, memory, storage devices, power adapter, panel and touchscreen.

- * PRODUCTS, HOWEVER, THAT FAIL DUE TO MISUSE, ACCIDENT, IMPROPER INSTALLATION OR UNAUTHORIZED REPAIR SHALL BE TREATED AS OUT OF WARRANTY AND CUSTOMERS SHALL BE BILLED FOR REPAIR AND SHIPPING CHARGES.

Technical Support & Services

1. Visit the IBASE website at www.ibase.com.tw to find the latest information about the product.
2. If you need any further assistance from your distributor or sales representative, prepare the following information of your product and elaborate upon the problem.
 - Product model name
 - Product serial number
 - Detailed description of the problem
 - The error messages in text or in screenshots if there is any
 - The arrangement of the peripherals
 - Software in use (such as OS and application software, including the version numbers)
3. If repair service is required, you can download the RMA form at <http://www.ibase.com.tw/english/Supports/RMAService/>. Fill out the form and contact your distributor or sales representative.

Table of Contents

Chapter 1	General Information	1
1.1	Introduction	2
1.2	Features	2
1.3	Packing List	3
1.4	Specifications	3
1.5	Block Diagram	5
1.6	Board Layout	6
1.7	Dimensions	7
Chapter 2	Hardware Configuration	9
2.1	ET977 COM Express Connectors	11
Chapter 3	Drivers Installation	15
3.1	Introduction	16
3.2	AMD Ryzen™ V1000 Graphics Drivers	16
3.3	Realtek HD Audio Driver Installation	19
3.4	LAN Driver Installation	21
3.5	Observer Setup Wizard	23
Chapter 4	BIOS Setup	25
4.1	Introduction	26
4.2	BIOS Setup	26
4.3	Main Settings	27
4.4	Advanced Settings	27
4.5	Chipset Settings	42
4.6	Security Settings	43
4.7	Boot Settings	45
4.8	Save & Exit	46
Appendix	47
A.	I/O Port Address Map	48
B.	Interrupt Request Lines (IRQ)	51
C.	Watchdog Timer Configuration	52

This page is intentionally left blank.

Chapter 1

General Information

The information provided in this chapter includes:

- Features
- Packing List
- Optional Accessories
- Specifications
- Block Diagram
- Board Layout
- Board Dimensions

1.1 Introduction

ET977 is a COM Express Type-6 module supporting AMD V1000/R1000 series APUs and supports 32GB DDR4-2400 ECC memory modules

Standard features supported with interface on the carrier board include an Intel® I210IT Gigabit controller, 4x USB 3.1 ports, 8x USB2.0 ports, and 2x SATA 3.0 ports. ET977 measures 125mm x 95mm and supports the Windows 10 (64bit) OS, with an operating temperature range of 0°C to 60°C.

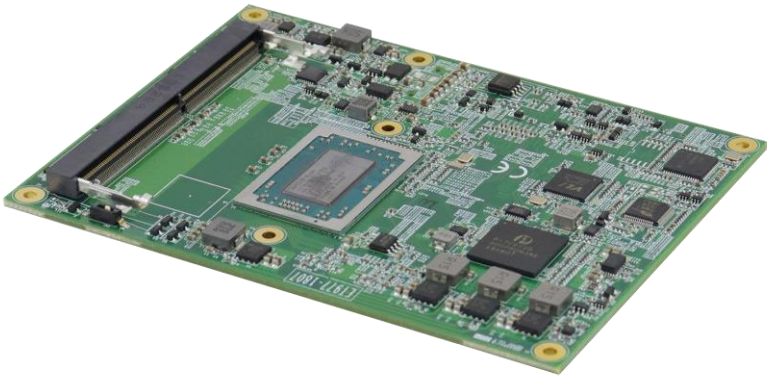

ET977

1.2 Features

- AMD Ryzen™ Embedded V1000/R1000 on board
- 2x DDR4 SO-DIMM expandable up to 32 GB, ECC supported
- V1000 series: 3 x DDI + 1x (eDP or LVDS)
R1000 series: 2 x DDI+1x (eDP or LVDS)
- 1 x Intel® PCIe GbE LAN, 8x USB 2.0, 4x USB 3.1, 2x SATA III
- 1x PCIe (x8), 6x PCIe (x1)
- Configurable watchdog timer, TPM 2.0, Digital I/O

1.3 Packing List

Your ET977 package should include the items listed below. If any of the items below is missing, contact the distributor or dealer from whom you purchased the product.

- ET977 COM Express Module x 1
- Disk x 1
(including drivers and flash memory utility)
- This User’s Manual x 1

1.4 Specifications

Product name	<ul style="list-style-type: none"> • ET977-1807 • ET977-1807LV • ET977-1605 • ET977-1605LV • ET977-1606LV • ET977-1505LV 			
System				
Operating system	Windows 10 (64-bit)			
CPU & Chipset	AMD Ryzen™ Embedded V1000 / R1000 APU onboard			
CPU TYPE	V1807B APU	V1605B APU	R1606G APU	R1505G APU
Memory	2 x DDR4-2400 SO-DIMM, expandable up to 32 GB, ECC compatible			
Graphics	AMD Vega GPU integrated			
LVDS	24-bit dual channel via NXP PTN3460 for eDP to LVDS P/N: PTN3460 or eDP			
LAN	1x Intel® I210IT GbE, co-lay Intel I211AT via carrier board			
Display	3 x DDI + 1x (eDP or LVDS)		2 x DDI+1x (eDP or LVDS)	
USB	4x USB3.1 ports[USB 3.1 x3 ports (VLI VL822-Q7) via carrier board] 8x USB2.0 ports [USB 2.0 x4 ports (VLI VL822-Q7) via carrier board]			

Expansion	1x PEG(8x)(Gen3), 4x PCI-E(1x)(Gen3), 2x PCI-E(1x)	1x PEG(4x)(Gen3), 3x PCI-E(1x)(Gen3), 3x PCI-E(1x)
Serial ATA	2x SATA 3.0 (6Gb/sec.) ports via carrier board	
LPC I/O	Fintek F81804U-I for 2x COM port x2 (TX/RX), -GPIO, Brightness control	
Digital IO	4 in & 4 out	
Audio	AMD V1000/R1000 series APU built-in HD interface	
Watchdog	Yes (256 segments, 0, 1, 2...255. sec/min)	
Connector to carrier board	Two 220-pin connectors (A-B & C-D) [COM Express 3.0 standard]	
Power	+12V, +5VSB, 8.5V~ 20V (DC-IN)	
TPM 2.0	Infineon SLB9670VQ2	
Certification	CE (EN55032:2012), FCC Class B	
OS support	Windows 10 (64bit)	
Board size	125mm x 95mm	
RoHS 2	Yes	
Operating temperature	0°C~60°C	
Storage temperature	-20°C~80°C	

All specifications are subject to change without prior notice.

1.5 Block Diagram

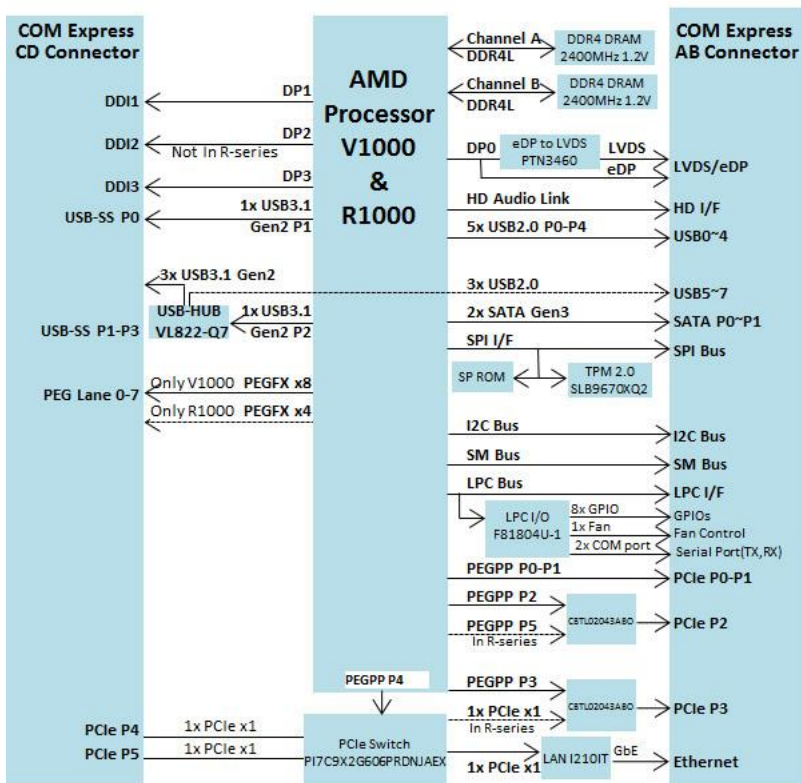

1.6 Board Layout

Top View

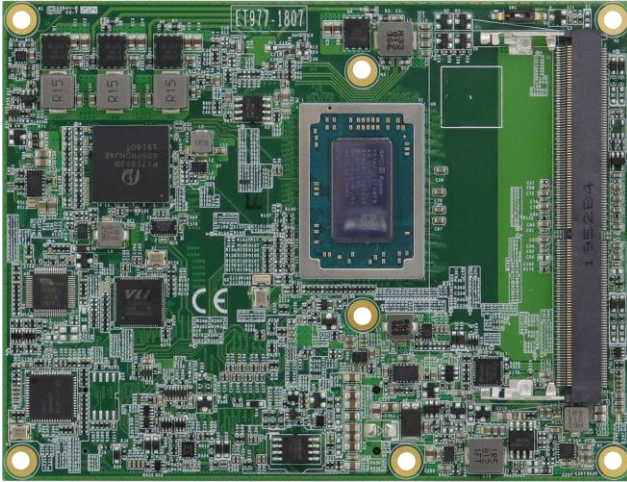

Bottom View

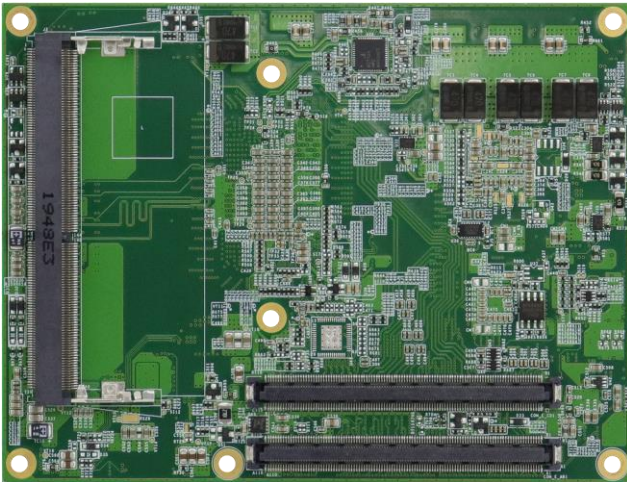

* The pictures above are for reference only.

1.7 Dimensions

Unit: mm

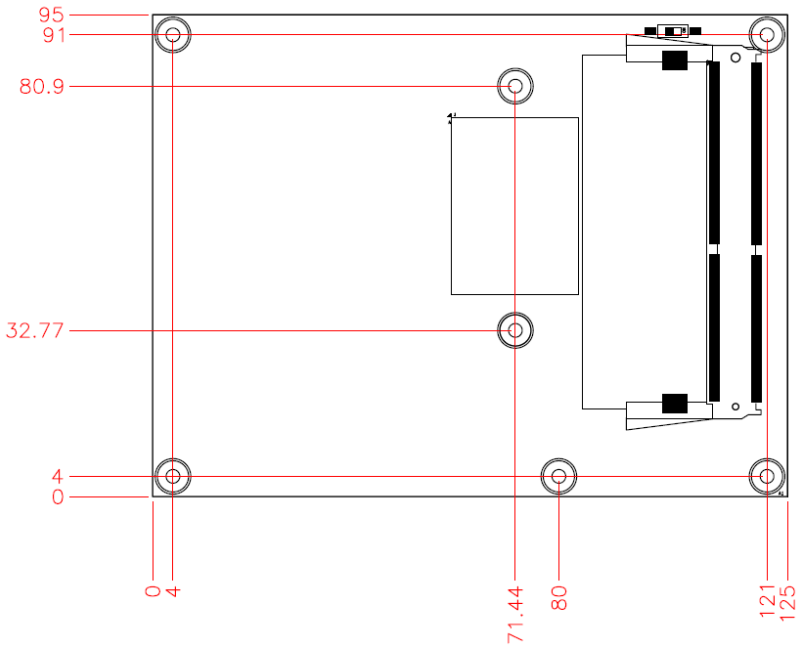

This page is intentionally left blank.

Chapter 2

Hardware Configuration

This section provides information on jumper settings and connectors on the board in order to set up a workable system. The topics covered are:

- Memory Installation
- Connector locations and information

2.1 Installing the Memory

To install the modules, locate the memory slot (J4, J7) on the board and perform the following steps:

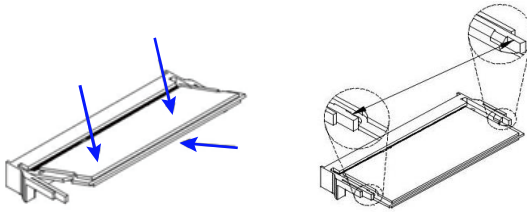

1. Align the key of the memory module with that on the memory slot and insert the module slantwise.
2. Gently push the module in an upright position until the clips of the slot close to hold the module in place when the module touches the bottom of the slot.

To remove the module, press the clips outwards with both hands, and the module will pop-up.

2.2 ET977 COM Express Connectors

COM Express Module Type 6 Connector (COM_E_AB1, COM_E_CD1)

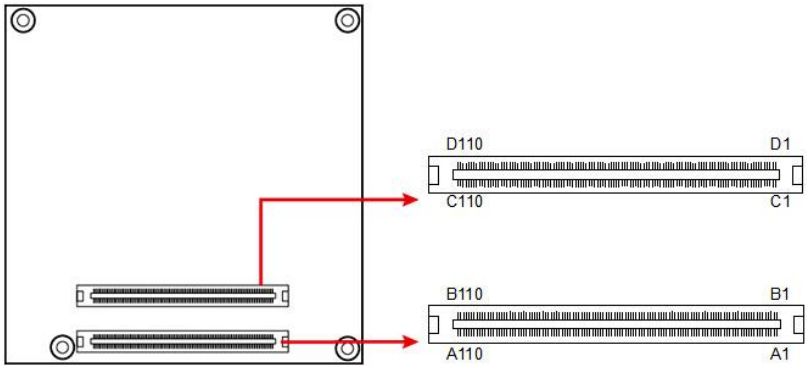

Row A		Row B		Row C		Row D	
Pin	Signal	Pin	Signal	Pin	Signal	Pin	Signal
A1	GND (FIXED)	B1	GND (FIXED)	C1	GND (FIXED)	D1	GND (FIXED)
A2	GBE0_MDI3-	B2	GBE0_ACT#	C2	GND	D2	GND
A3	GBE0_MDI3+	B3	LPC_FRAME#	C3	USB_SSRX0-	D3	USB_SSTX0-
A4	GBE0_LINK100#	B4	LPC_AD0	C4	USB_SSRX0+	D4	USB_SSTX0+
A5	GBE0_LINK1000#	B5	LPC_AD1	C5	GND	D5	GND
A6	GBE0_MDI2-	B6	LPC_AD2	C6	USB_SSRX1-	D6	USB_SSTX1-
A7	GBE0_MDI2+	B7	LPC_AD3	C7	USB_SSRX1+	D7	USB_SSTX1+
A8	GBE0_LINK#	B8	LPC_DRQ0#	C8	GND	D8	GND
A9	GBE0_MDI1-	B9	NC	C9	USB_SSRX2-	D9	USB_SSTX2-
A10	GBE0_MDI1+	B10	LPC_CLK	C10	USB_SSRX2+	D10	USB_SSTX2+
A11	GND (FIXED)	B11	GND (FIXED)	C11	GND (FIXED)	D11	GND (FIXED)
A12	GBE0_MDI0-	B12	PWRBTN#	C12	USB_SSRX3-	D12	USB_SSTX3-
A13	GBE0_MDI0+	B13	SMB_CK	C13	USB_SSRX3+	D13	USB_SSTX3+
A14	GBE0_CTREF	B14	SMB_DAT	C14	GND	D14	GND
A15	SUS_S3#	B15	SMB_ALERT#	C15	NC	D15	DDI1_CTRLCLK_A UX+
A16	SATA0_TX+	B16	SATA1_TX+	C16	NC	D16	DDI1_CTRLDATA_A UX-
A17	SATA0_TX-	B17	SATA1_TX-	C17	RSVD	D17	RSVD
A18	SUS_S4#	B18	NC	C18	RSVD	D18	RSVD
A19	SATA0_RX+	B19	SATA1_RX+	C19	NC	D19	NC
A20	SATA0_RX-	B20	SATA1_RX-	C20	NC	D20	NC
A21	GND (FIXED)	B21	GND (FIXED)	C21	GND (FIXED)	D21	GND (FIXED)
A22	NC	B22	NC	C22	NC	D22	NC
A23	NC	B23	NC	C23	NC	D23	NC
A24	SUS_S5#	B24	PWR_OK	C24	DDI1_HPD	D24	RSVD
A25	NC	B25	NC	C25	NC	D25	RSVD
A26	NC	B26	NC	C26	NC	D26	DDI1_PAIR0+
A27	BATLOW#	B27	WDT	C27	RSVD	D27	DDI1_PAIR0-
A28	SATA_ACT#	B28	NC	C28	RSVD	D28	RSVD
A29	HDA_SYNC	B29	NC	C29	NC	D29	DDI1_PAIR1+
A30	HDA_RST#	B30	HDA_SDIN0	C30	NC	D30	DDI1_PAIR1-

Row A		Row B		Row C		Row D	
Pin	Signal	Pin	Signal	Pin	Signal	Pin	Signal
A31	GND (FIXED)	B31	GND (FIXED)	C31	GND (FIXED)	D31	GND (FIXED)
A32	HDA_BITCLK	B32	SPKR	C32	DDI2_CTRLCLK_AUX+ (R1000 NC)	D32	DDI1_PAIR2+
A33	HDA_SDOUT	B33	I2C_CK	C33	DDI2_CTRLDATA_AUX- (R1000 NC)	D33	DDI1_PAIR2-
A34	BIOS_DIS0#	B34	I2C_DAT	C34	DDI2_DDC_AUX_SEL (R1000 NC)	D34	DDI1_DDC_AUX_SE L
A35	THRMTrip#	B35	THRM#	C35	RSVD	D35	RSVD
A36	USB6-	B36	USB7-	C36	DDI3_CTRLCLK_AUX+	D36	DDI1_PAIR3+
A37	USB6+	B37	USB7+	C37	DDI3_CTRLDATA_AUX-	D37	DDI1_PAIR3-
A38	USB_6_7_OC#	B38	USB_4_5_OC#	C38	DDI3_DDC_AUX_SEL	D38	RSVD
A39	USB4-	B39	USB5-	C39	DDI3_PAIR0+	D39	DDI2_PAIR0+ (R1000 NC)
A40	USB4+	B40	USB5+	C40	DDI3_PAIR0-	D40	DDI2_PAIR0- (R1000 NC)
A41	GND (FIXED)	B41	GND (FIXED)	C41	GND (FIXED)	D41	GND (FIXED)
A42	USB2-	B42	USB3-	C42	DDI3_PAIR1+	D42	DDI2_PAIR1+ (R1000 NC)
A43	USB2+	B43	USB3+	C43	DDI3_PAIR1-	D43	DDI2_PAIR1- (R1000 NC)
A44	USB_2_3_OC#	B44	USB_0_1_OC#	C44	DDI3_HPD	D44	DDI2_HPD (R1000 NC)
A45	USB0-	B45	USB1-	C45	RSVD	D45	RSVD
A46	USB0+	B46	USB1+	C46	DDI3_PAIR2+	D46	DDI2_PAIR2+ (R1000 NC)
A47	VCC_RTC	B47	NC	C47	DDI3_PAIR2-	D47	DDI2_PAIR2- (R1000 NC)
A48	RSVD	B48	NC	C48	RSVD	D48	RSVD
A49	GBE0_SDP	B49	SYS_RESET#	C49	DDI3_PAIR3+	D49	DDI2_PAIR3+ (R1000 NC)
A50	LPC_SERIRQ	B50	CB_RESET#	C50	DDI3_PAIR3-	D50	DDI2_PAIR3- (R1000 NC)
A51	GND (FIXED)	B51	GND (FIXED)	C51	GND (FIXED)	D51	GND (FIXED)
A52	PCIE_TX5+	B52	PCIE_RX5+	C52	PEG_RX0+	D52	PEG_TX0+
A53	PCIE_TX5-	B53	PCIE_RX5-	C53	PEG_RX0-	D53	PEG_TX0-
A54	GPI0	B54	GPO1	C54	NC	D54	NC
A55	PCIE_TX4+	B55	PCIE_RX4+	C55	PEG_RX1+	D55	PEG_TX1+
A56	PCIE_TX4-	B56	PCIE_RX4-	C56	PEG_RX1-	D56	PEG_TX1-
A57	GND	B57	GPO2	C57	NC	D57	TYPE2#
A58	PCIE_TX3+	B58	PCIE_RX3+	C58	PEG_RX2+	D58	PEG_TX2+
A59	PCIE_TX3-	B59	PCIE_RX3-	C59	PEG_RX2-	D59	PEG_TX2-
A60	GND (FIXED)	B60	GND (FIXED)	C60	GND (FIXED)	D60	GND (FIXED)
A61	PCIE_TX2+	B61	PCIE_RX2+	C61	PEG_RX3+	D61	PEG_TX3+
A62	PCIE_TX2-	B62	PCIE_RX2-	C62	PEG_RX3-	D62	PEG_TX3-
A63	GPI1	B63	GPO3	C63	RSVD	D63	RSVD
A64	PCIE_TX1+	B64	PCIE_RX1+	C64	RSVD	D64	RSVD
A65	PCIE_TX1-	B65	PCIE_RX1-	C65	PEG_RX4+(R1000 NC)	D65	PEG_TX4+(R1000 NC)
A66	GND	B66	WAKE0#	C66	PEG_RX4-(R1000 NC)	D66	PEG_TX4-(R1000 NC)
A67	GPI2	B67	WAKE1#	C67	NC	D67	GND
A68	PCIE_TX0+	B68	PCIE_RX0+	C68	PEG_RX5+(R1000 NC)	D68	PEG_TX5+(R1000 NC)
A69	PCIE_TX0-	B69	PCIE_RX0-	C69	PEG_RX5-(R1000 NC)	D69	PEG_TX5-(R1000 NC)
A70	GND (FIXED)	B70	GND (FIXED)	C70	GND (FIXED)	D70	GND (FIXED)
A71	LVDS_A0+/ eDP_TX2+	B71	LVDS_B0+	C71	PEG_RX6+(R1000 NC)	D71	PEG_TX6+(R1000 NC)

Row A		Row B		Row C		Row D	
-------	--	-------	--	-------	--	-------	--

Pin	Signal	Pin	Signal	Pin	Signal	Pin	Signal
A72	LVDS_A0-/ eDP_TX2-	B72	LVDS_B0-	C72	PEG_RX6- (R1000 NC)	D72	PEG_TX6- (R1000 NC)
A73	LVDS_A1+/ eDP_TX1+	B73	LVDS_B1+	C73	GND	D73	GND
A74	LVDS_A1-/ eDP_TX1-	B74	LVDS_B1-	C74	PEG_RX7+ (R1000 NC)	D74	PEG_TX7+ (R1000 NC)
A75	LVDS_A2+/ eDP_TX0+	B75	LVDS_B2+	C75	PEG_RX7- (R1000 NC)	D75	PEG_TX7- (R1000 NC)
A76	LVDS_A2-/ eDP_TX0-	B76	LVDS_B2-	C76	GND	D76	GND
A77	LVDS_VDD_EN/ eDP_VDD_EN	B77	LVDS_B3+	C77	RSVD	D77	RSVD
A78	LVDS_A3+	B78	LVDS_B3-	C78	NC	D78	NC
A79	LVDS_A3-	B79	LVDS_BKLT_EN/ eDP_BKLT_EN	C79	NC	D79	NC
A80	GND (FIXED)	B80	GND (FIXED)	C80	GND (FIXED)	D80	GND (FIXED)
A81	LVDS_A_CK+/ eDP_TX3+	B81	LVDS_B_CK+	C81	NC	D81	NC
A82	LVDS_A_CK-/eDP_TX3-	B82	LVDS_B_CK-	C82	NC	D82	NC
A83	LVDS_I2C_CK/ eDP_AUX+	B83	LVDS_BKLT_CTRL	C83	RSVD	D83	RSVD
A84	LVDS_I2C_DAT/ eDP_AUX-	B84	VCC_5V_SBY	C84	GND	D84	GND
A85	GPI3	B85	VCC_5V_SBY	C85	NC	D85	NC
A86	RSVD	B86	VCC_5V_SBY	C86	NC	D86	NC
A87	eDP_HPDP	B87	VCC_5V_SBY	C87	GND	D87	GND
A88	PCI_CLK_REF+	B88	BIOS_DIS1#	C88	NC	D88	NC
A89	PCI_CLK_REF-	B89	NC	C89	NC	D89	NC
A90	GND (FIXED)	B90	GND (FIXED)	C90	GND (FIXED)	D90	GND (FIXED)
A91	SPI_POWER	B91	NC	C91	NC	D91	NC
A92	SPI_MISO	B92	NC	C92	NC	D92	NC
A93	GPO0	B93	NC	C93	GND	D93	GND
A94	SPI_CLK	B94	NC	C94	NC	D94	NC
A95	SPI_MOSI	B95	NC	C95	NC	D95	NC
A96	TPM_PP	B96	NC	C96	GND	D96	GND
A97	NC	B97	SPI_CS#	C97	RSVD	D97	RSVD
A98	SER0_TX	B98	RSVD	C98	NC	D98	NC
A99	SER0_RX	B99	RSVD	C99	NC	D99	NC
A100	GND (FIXED)	B100	GND (FIXED)	C100	GND (FIXED)	D100	GND (FIXED)
A101	SER1_TX	B101	FAN_PWMOUT	C101	NC	D101	NC
A102	SER1_RX	B102	FAN_TACHIN	C102	NC	D102	NC
A103	NC	B103	NC	C103	GND	D103	GND
A104	VCC_12V	B104	VCC_12V	C104	VCC_12V	D104	VCC_12V
A105	VCC_12V	B105	VCC_12V	C105	VCC_12V	D105	VCC_12V
A106	VCC_12V	B106	VCC_12V	C106	VCC_12V	D106	VCC_12V
A107	VCC_12V	B107	VCC_12V	C107	VCC_12V	D107	VCC_12V
A108	VCC_12V	B108	VCC_12V	C108	VCC_12V	D108	VCC_12V
A109	VCC_12V	B109	VCC_12V	C109	VCC_12V	D109	VCC_12V
A110	GND (FIXED)	B110	GND (FIXED)	C110	GND (FIXED)	D110	GND (FIXED)

2.3 DDR4 SO-DIMM Slot & ATX/AT Switch

Function	Connector Name
DDR4 SO-DIMM Slot	J1, J3
ATX/AT Switch	SW1

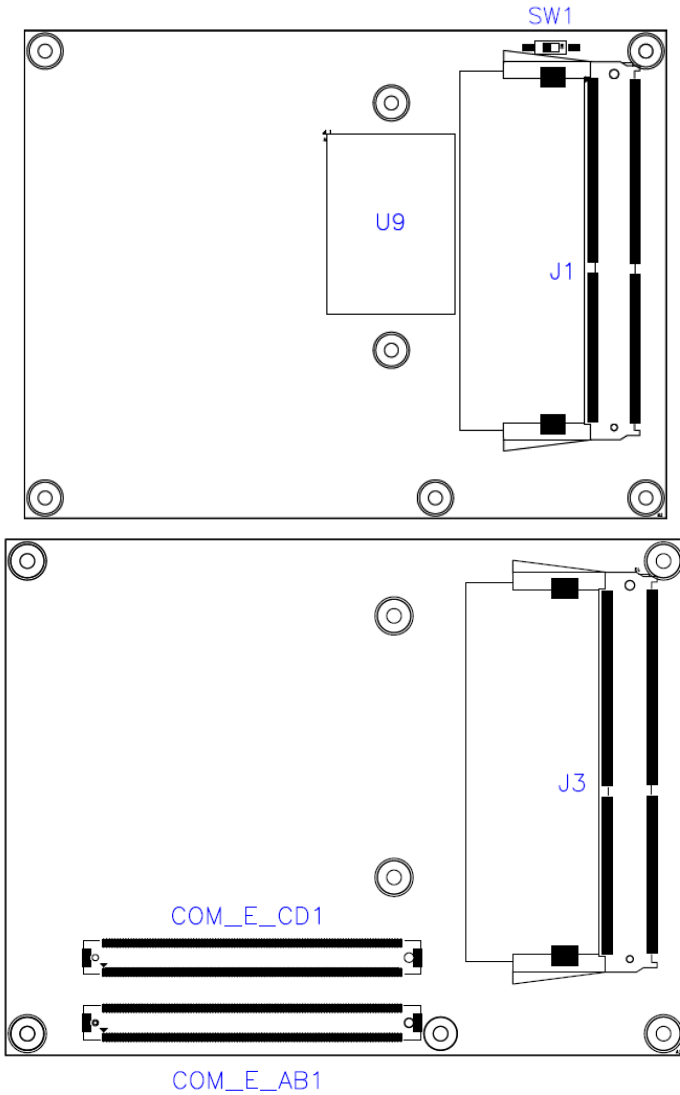

Chapter 3

Drivers Installation

This chapter introduces installation of the following drivers:

- AMD Ryzen™ V1000/R1000 Graphics Drivers
- Realtek HD Audio Driver Installation
- LAN Driver Installation
- Observer Setup Wizard

3.1 Introduction

This section describes the installation procedures for software and drivers.

3.2 AMD Ryzen™ V1000/R1000 Graphics Drivers

1. Insert the driver CD/DVD into the corresponding drive. Click **AMD Ryzen V1000 Drivers** and then **AMD Ryzen V1000/R1000 Graphics Drivers**.

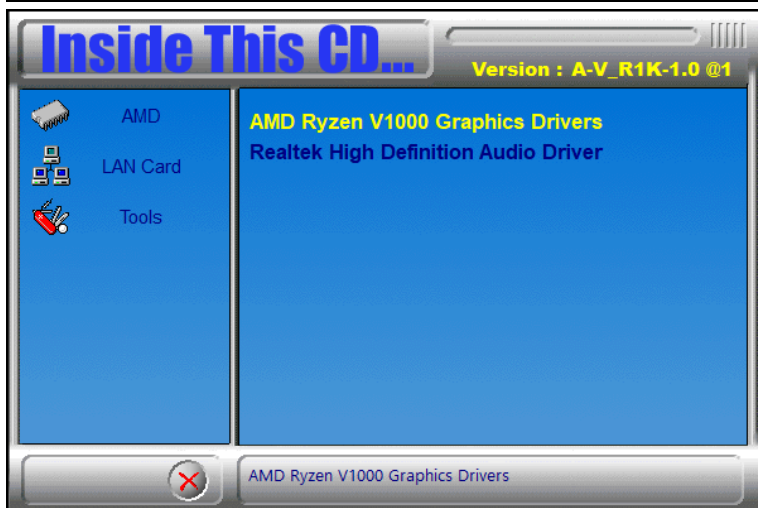
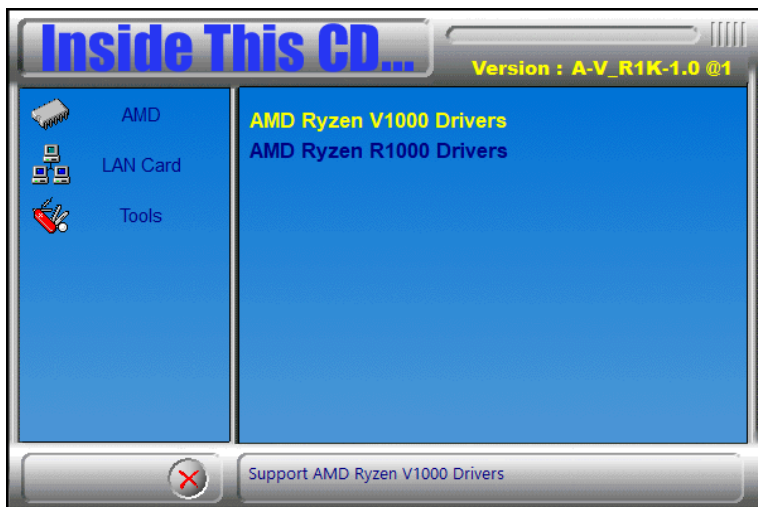

2. Read the software license agreement and click **Accept and Install** to proceed.

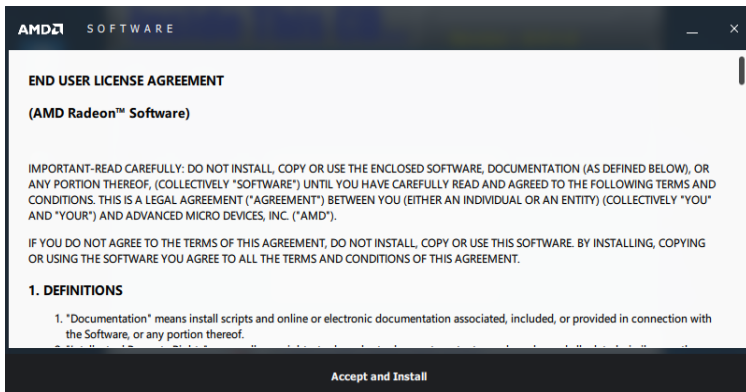

3. Choose and click on either **Express Install** or **Custom Install**.

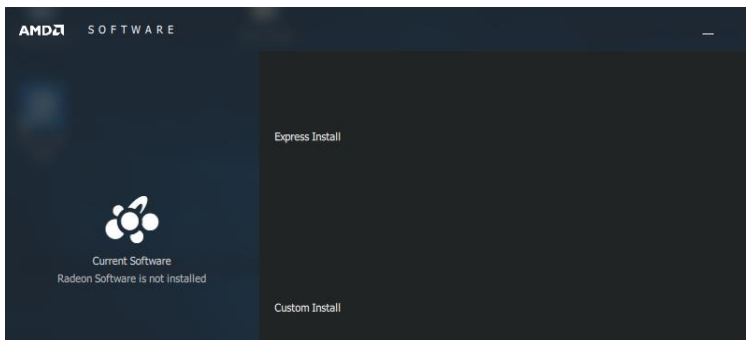



4. After the installation, restart the computer when prompted for changes to take effect.

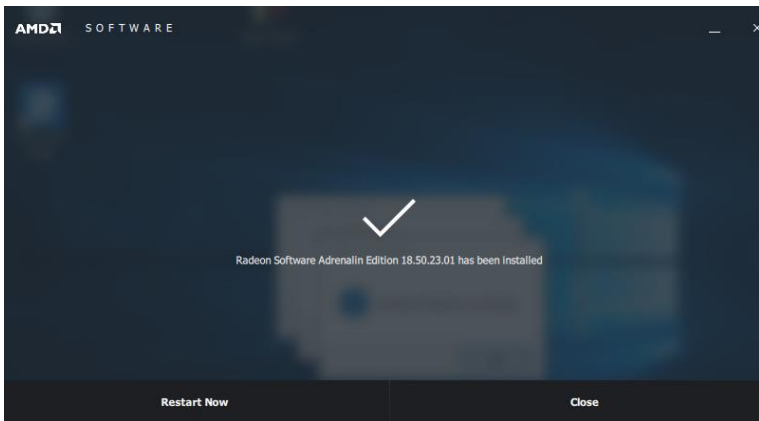

3.3 Realtek HD Audio Driver Installation

1. Click **AMD** on the left pane and then **AMD Ryzen V1000/R1000 Drivers**.

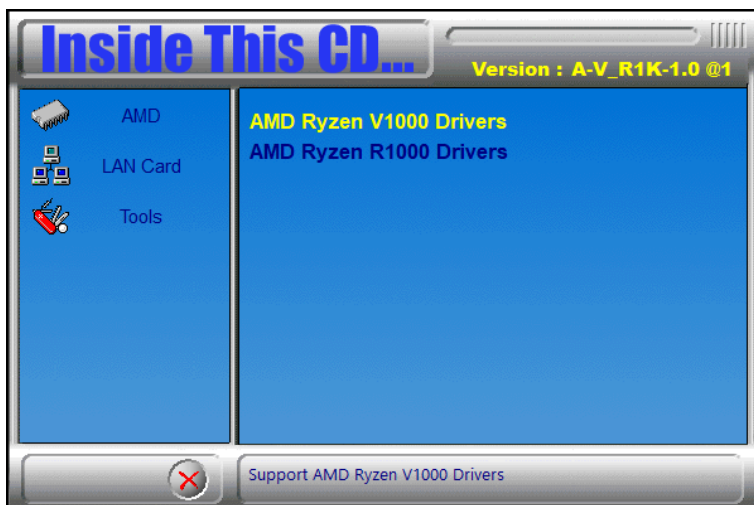

2. Click **Realtek High Definition Audio Driver**.

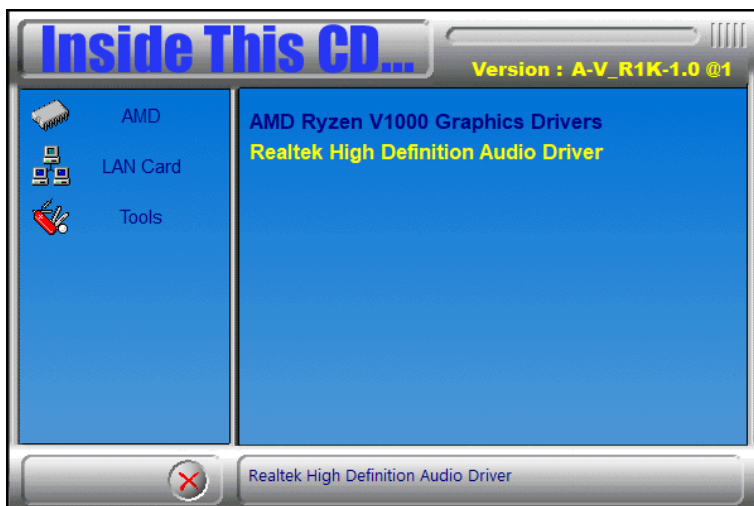

3. On the *Welcome* screen of the InstallShield Wizard, click **Yes** to continue with the installation.

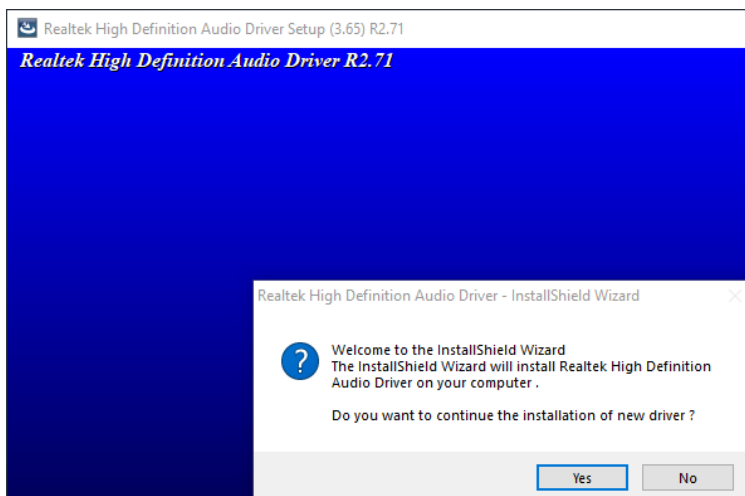

4. When installation is complete, restart the computer when prompted.

Restarting Windows

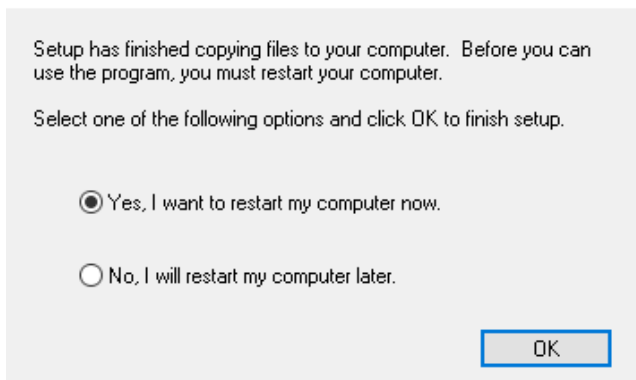

3.4 LAN Driver Installation

1. Click **LAN Card** on the left pane and then **Intel LAN Controller Drivers**.



2. Click **Intel(R) I21x Gigabit Networks Drivers**.



3. When the *Welcome* screen to the install wizard appears, click **Next**.
4. On the following screen, accept the license agreement and click **Next**.

5. On the *Setup Options* screen, tick the checkbox to select the desired driver(s) for installation. Then click **Next** to continue.

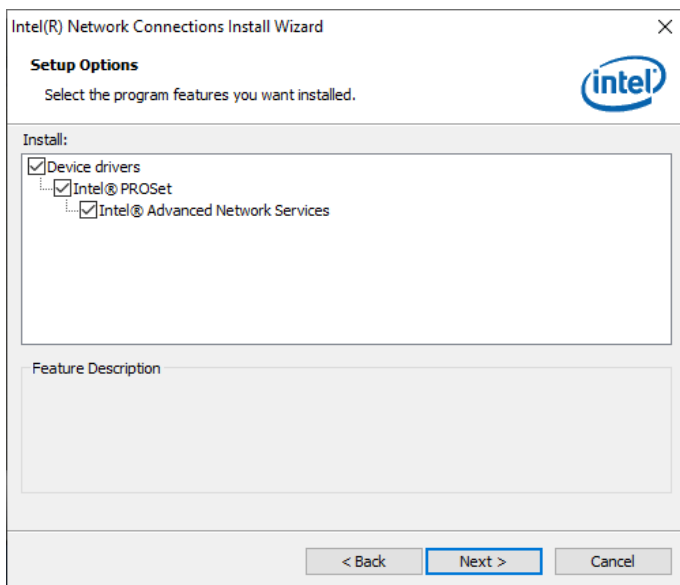

6. Click **Install** to begin the installation.

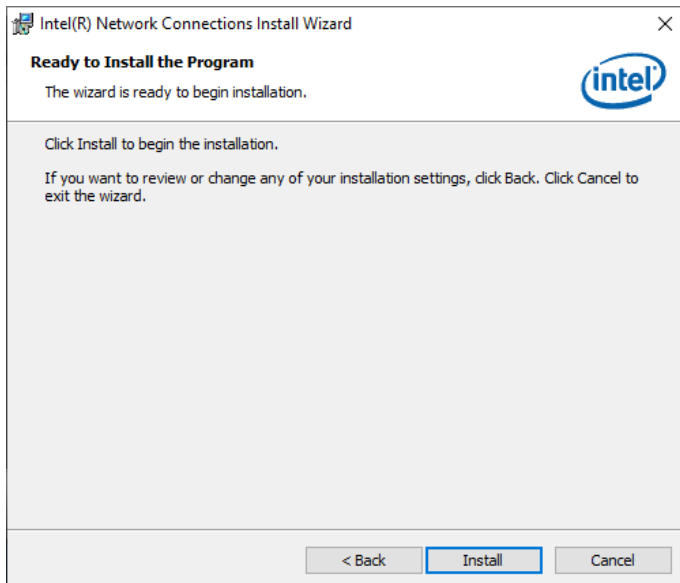

7. Once "Install wizard is Completed," click **Finish**.

3.5 Observer Setup Wizard

1. Click **Tools** on the left pane and then **Observer**.

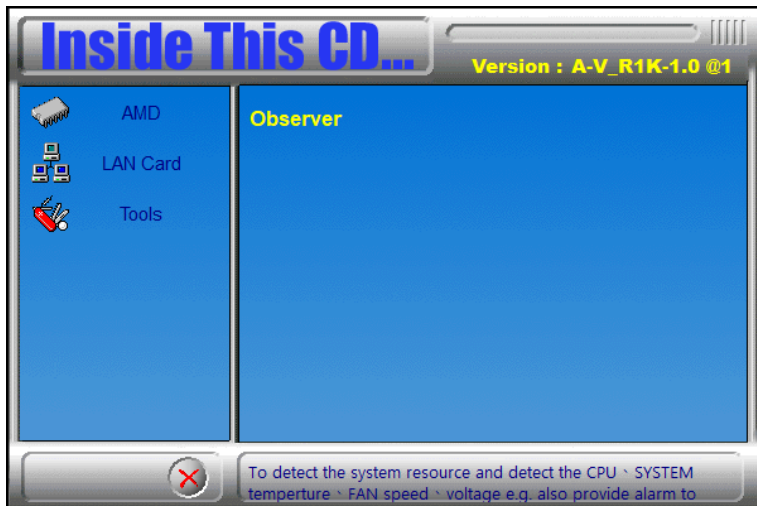

2. On the Welcome screen, click **Next** to install Observer on your system. It is recommended that you close all other applications before continuing.

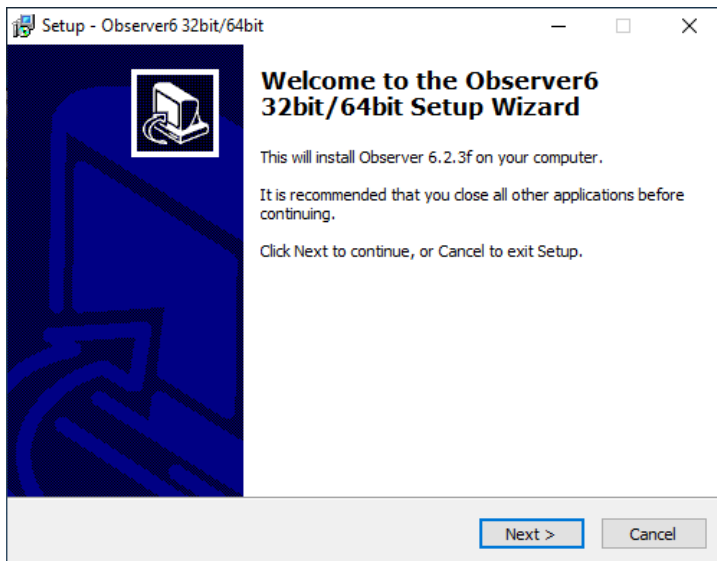

- The following screen shows the installation destination location or folder. To continue, click **Next**. If you would like to select a different folder, click **Browse**.

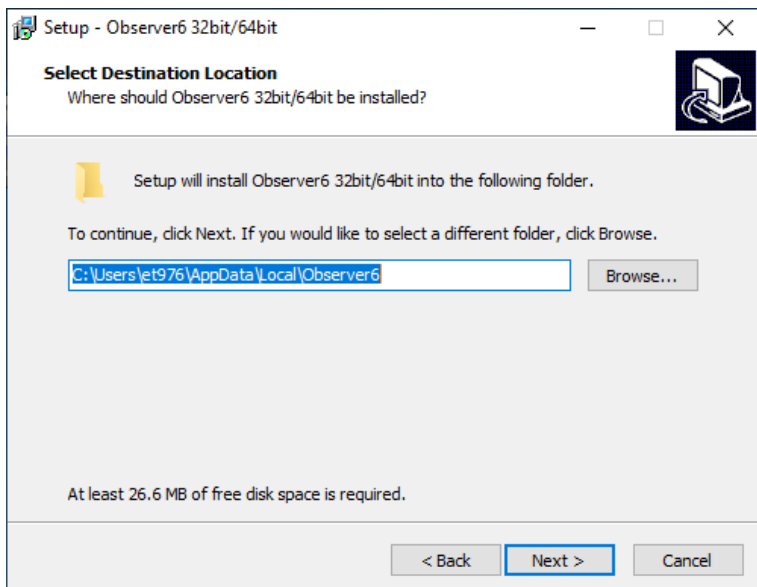

- In the **Ready to Install** screen, click **Install** to continue.
- To complete the installation, restart the computer when prompted. Click **Finish**.

Chapter 4

BIOS Setup

This chapter describes the different settings available in the AMI BIOS that comes with the board. The topics covered in this chapter are as follows:

- Main Settings
- Advanced Settings
- Chipset Settings
- Security Settings
- Boot Settings
- Save & Exit

4.1 Introduction

The BIOS (Basic Input/Output System) installed in the ROM of your computer system supports Intel® processors. The BIOS provides critical low-level support for standard devices such as disk drives, serial ports and parallel ports. It also provides password protection as well as special support for detailed fine-tuning of the chipset controlling the entire system.

4.2 BIOS Setup

The BIOS provides a Setup utility program for specifying the system configurations and settings. The BIOS ROM of the system stores the Setup utility. When you turn on the computer, the BIOS is immediately activated. Press the key immediately allows you to enter the Setup utility. If you are a little bit late pressing the key, POST (Power On Self Test) will continue with its test routines, thus preventing you from invoking the Setup.

If you still need to enter Setup, restart the system by pressing the "Reset" button or simultaneously pressing the <Ctrl>, <Alt> and <Delete> keys. You can also restart by turning the system Off and back On again.

The following message will appear on the screen:

```
Press <DEL> to Enter Setup
```

In general, press the arrow keys to highlight items, <Enter> to select, the <PgUp> and <PgDn> keys to change entries, <F1> for help, and <Esc> to quit.

When you enter the BIOS Setup utility, the *Main Menu* screen will appear on the screen. The Main Menu allows you to select from various setup functions and exit choices.

Warning: It is strongly recommended that you avoid making any changes to the chipset defaults.

These defaults have been carefully chosen by both AMI and your system manufacturer to provide the absolute maximum performance and reliability. Changing the defaults could make the system unstable and crash in some cases.

4.3 Main Settings

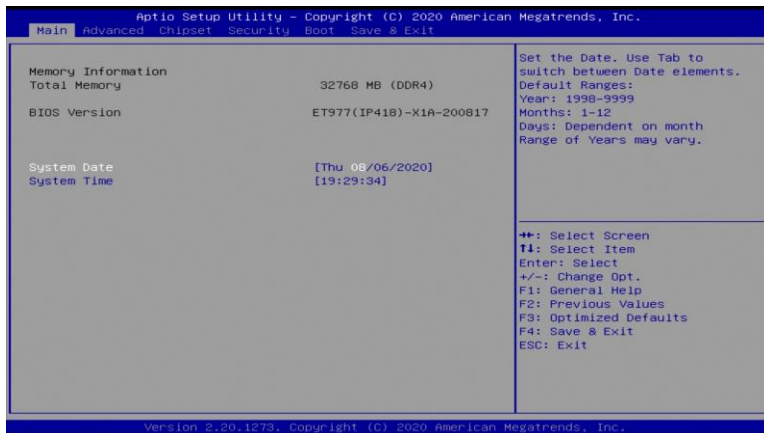

BIOS Setting	Description
System Date	Sets the date. Use the <Tab> key to switch between the data elements.
System Time	Set the time. Use the <Tab> key to switch between the data elements.

4.4 Advanced Settings

This section allows you to configure, improve your system and allows you to set up some system features according to your preference.

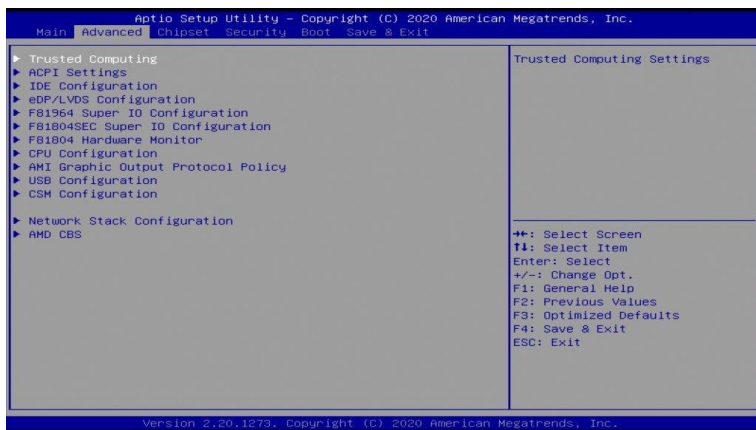

4.4.1 Trusted Computing

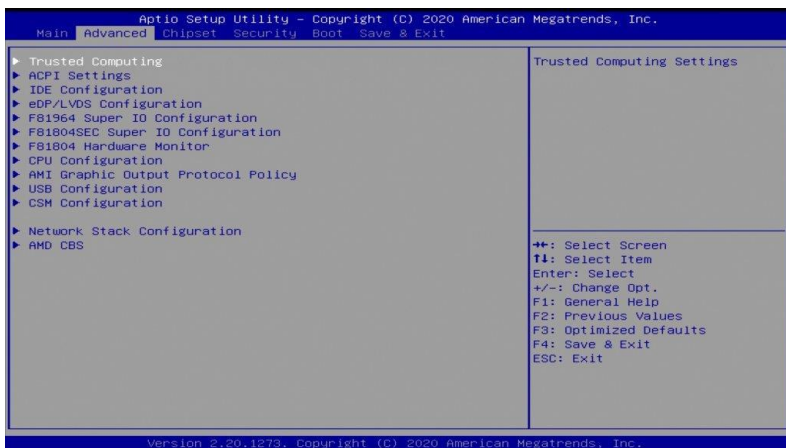

BIOS Setting	Description
Security Device Support	Enables or Disables BIOS support for security device. O.S. will not show Security Device. TCG EFI protocol and INT1A interface will not be available.
Pending operation	Schedule an operation for the Security Device. NOTE: Your computer will reboot during restart in order to change State of Security Device.

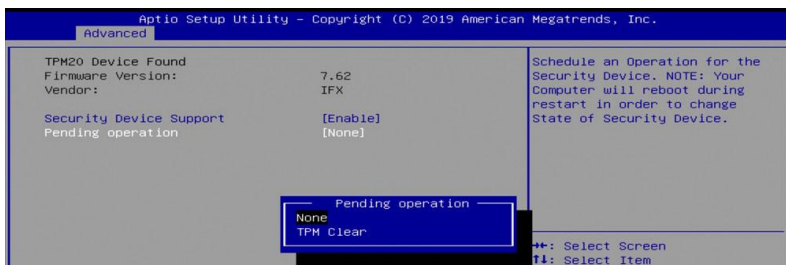

4.4.2 ACPI Settings

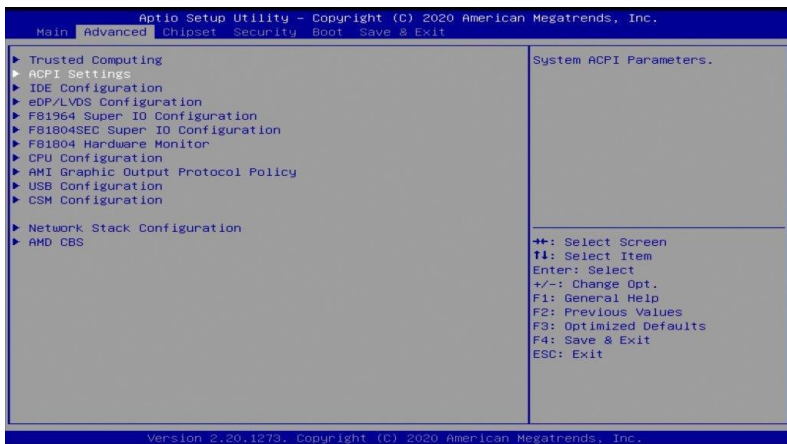

BIOS Setting	Description
Enable Hibernation	Enables / Disables the system ability to hibernate (OS/S4 Sleep State). This option may be not effective with some OS.
ACPI Sleep State	Selects an ACPI sleep state where the system will enter when the Suspend button is pressed.

4.4.3 IDE Configuration

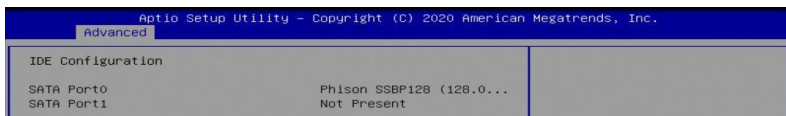
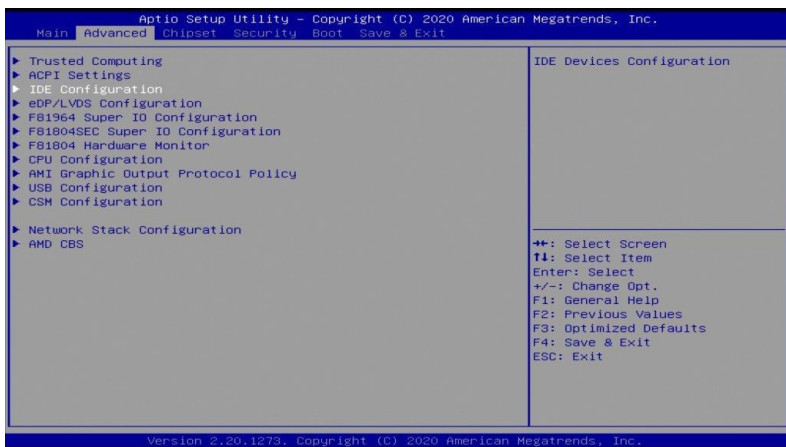

BIOS Setting	Description
SATA Ports	Detects the connection of SATA Port0 and SATA Port1.

4.4.4 eDP/LVDS Configuration

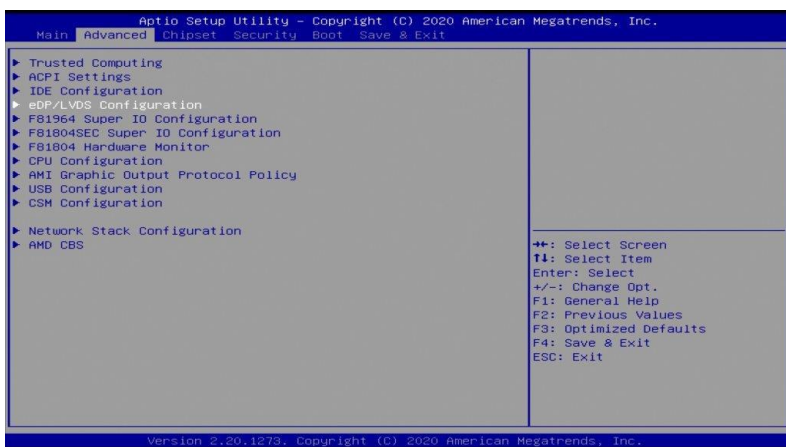

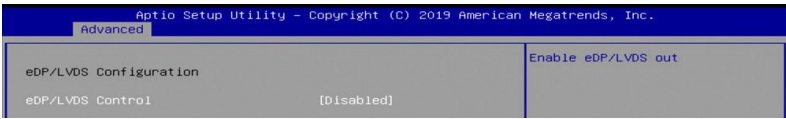

BIOS Setting	Description
eDP / LVDS Control	Enable or Disables eDP / LVDS out.

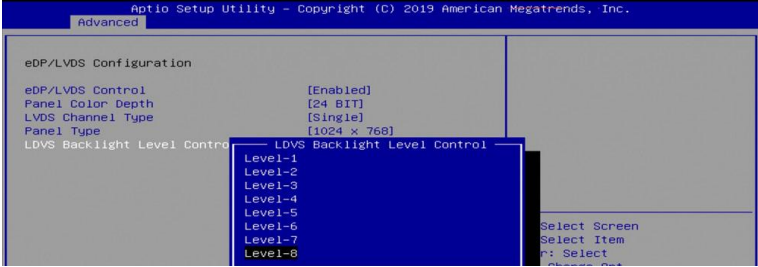
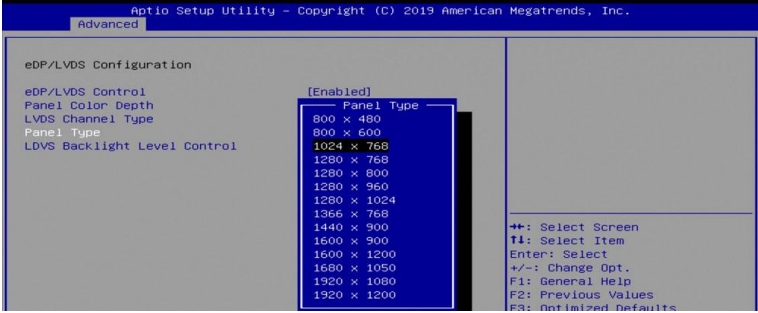
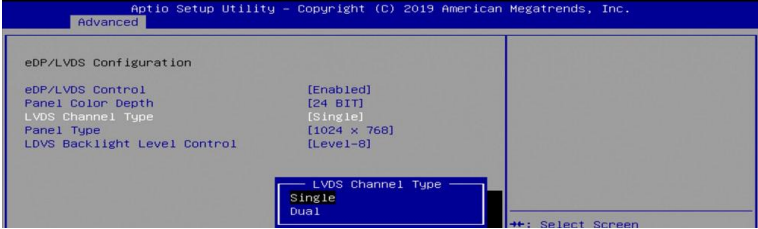
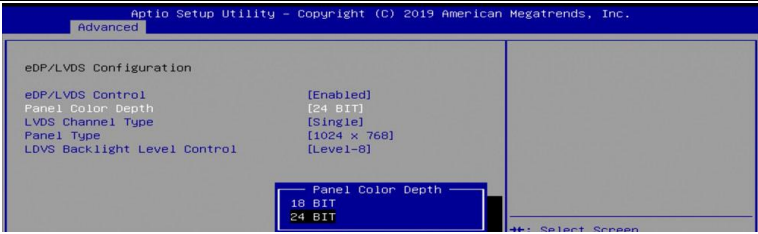

4.4.5 F81964 Super IO Configuration

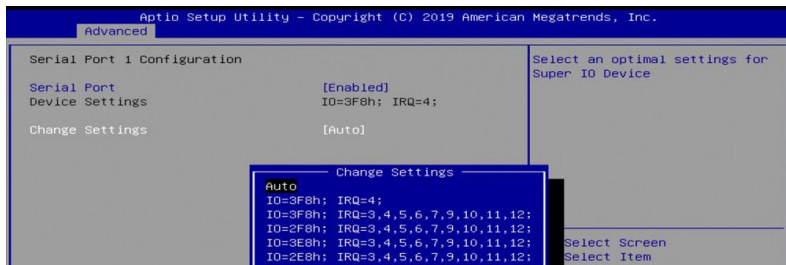
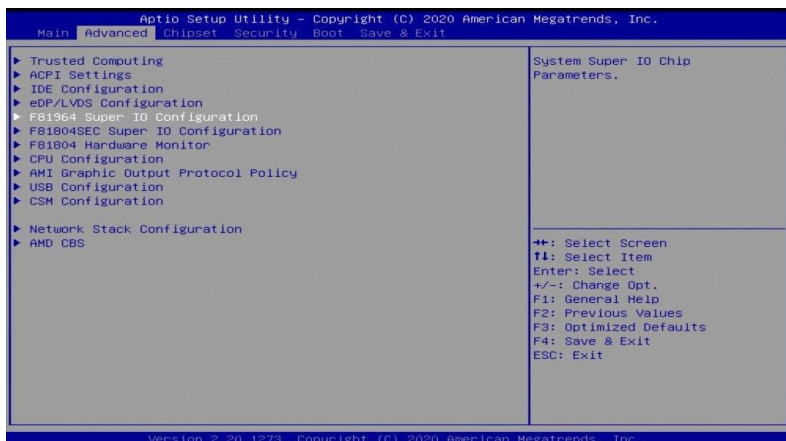

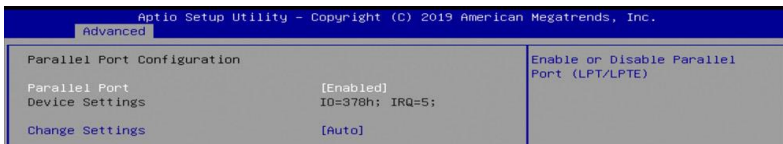
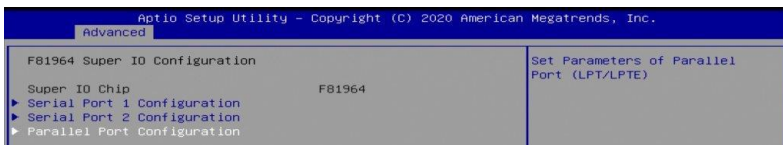
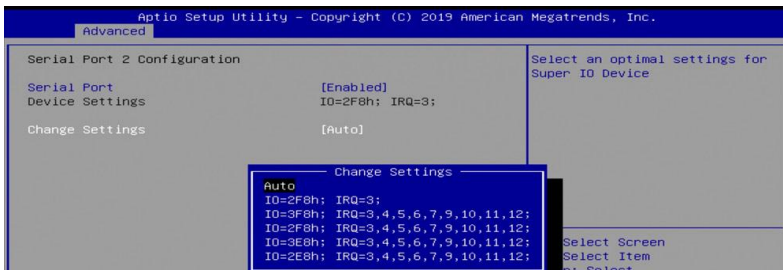

4.4.6 F81804SEC Super IO Configuration

Aptio Setup Utility - Copyright (C) 2020 American Megatrends, Inc.	
Main Advanced Chipset Security Boot Save & Exit	
<ul style="list-style-type: none"> ▶ Trusted Computing ▶ ACPI Settings ▶ IDE Configuration ▶ eDP/LVDS Configuration ▶ F81804 Super IO Configuration ▶ F81804SEC Super IO Configuration ▶ F81804 Hardware Monitor ▶ CPU Configuration ▶ AMI Graphic Output Protocol Policy ▶ USB Configuration ▶ CSM Configuration ▶ Network Stack Configuration ▶ AMD CBS 	<p>System Super IO Chip Parameters.</p> <hr/> <p> **+: Select Screen **I: Select Item Enter: Select +/-: Change Opt. F1: General Help F2: Previous Values F3: Optimized Defaults F4: Save & Exit ESC: Exit </p>
Version 2.20.1279. Copyright (C) 2020 American Megatrends, Inc.	

Aptio Setup Utility - Copyright (C) 2020 American Megatrends, Inc.	
Advanced	
<p>Serial Port 1 Configuration</p> <p>Serial Port [Enabled] Device Settings IO=3E8h; IRQ=6;</p>	<p>Enable or Disable Serial Port (COM)</p>

Aptio Setup Utility - Copyright (C) 2019 American Megatrends, Inc.	
Advanced	
<p>F81804SEC Super IO Configuration</p> <p>Super IO Chip F81804SEC</p> <ul style="list-style-type: none"> ▶ Serial Port 1 Configuration ▶ Serial Port 2 Configuration 	<p>Set Parameters of Serial Port 1 (COMA)</p>

Aptio Setup Utility - Copyright (C) 2020 American Megatrends, Inc.	
Advanced	
<p>Serial Port 2 Configuration</p> <p>Serial Port [Enabled] Device Settings IO=2E8h; IRQ=10;</p>	<p>Enable or Disable Serial Port (COM)</p>

4.4.7 F81804 Hardware Monitor

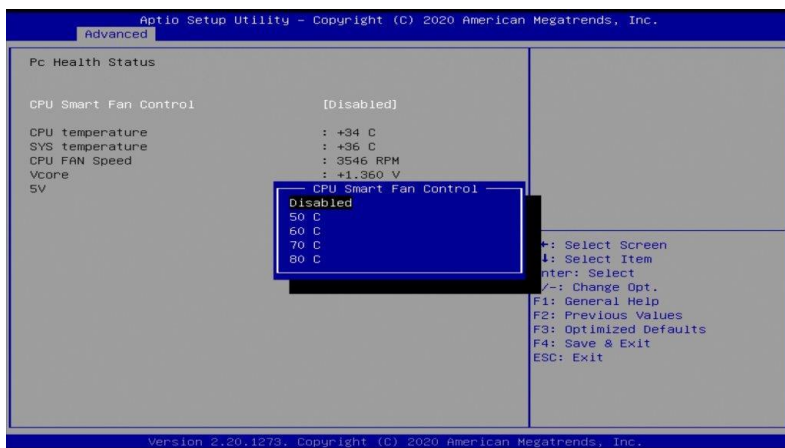
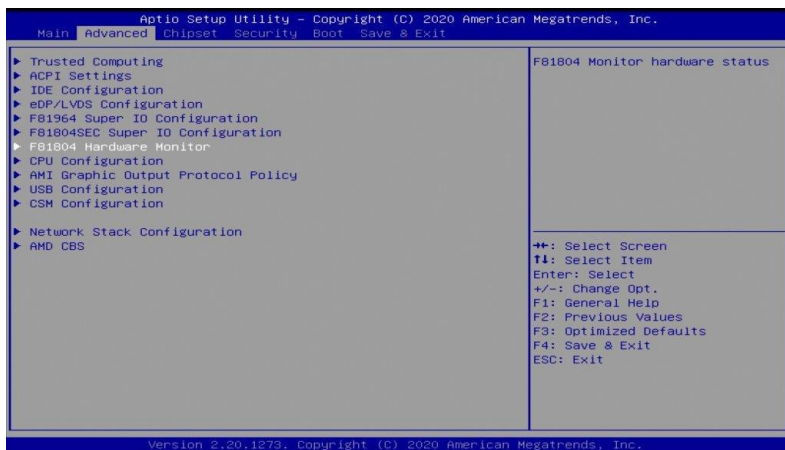

BIOS Setting	Description
CPU Smart Fan Control	Sets the temperature whereby the CPU smart fan is enabled.
Temperatures / Voltages	These fields are the parameters of the hardware monitoring function feature of the motherboard. The values are read-only values as monitored by the system and show the PC health status.

4.4.8 CPU Configuration

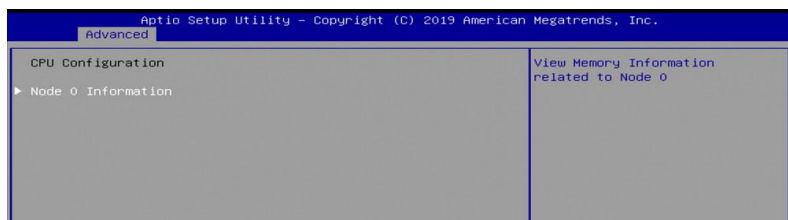
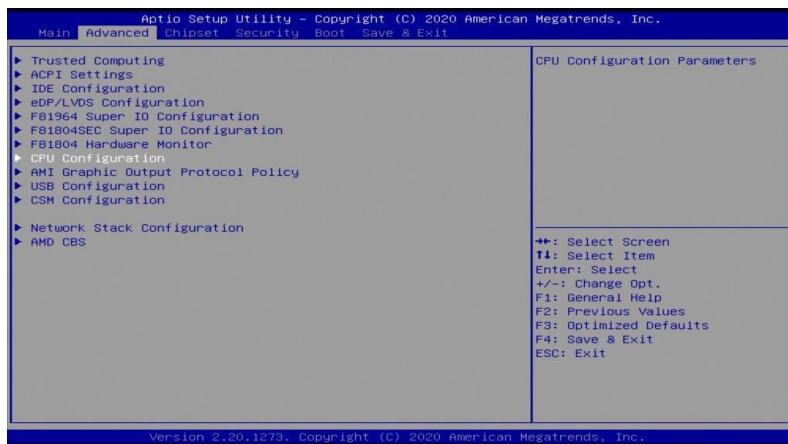

BIOS Setting	Description
Node 0 Information	Displays the memory information related to Node 0.

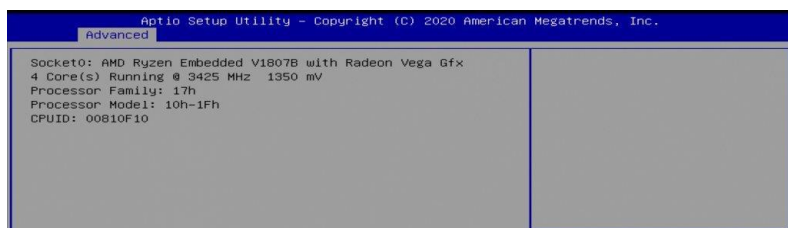

4.4.9 AMI Graphic Output Protocol Policy

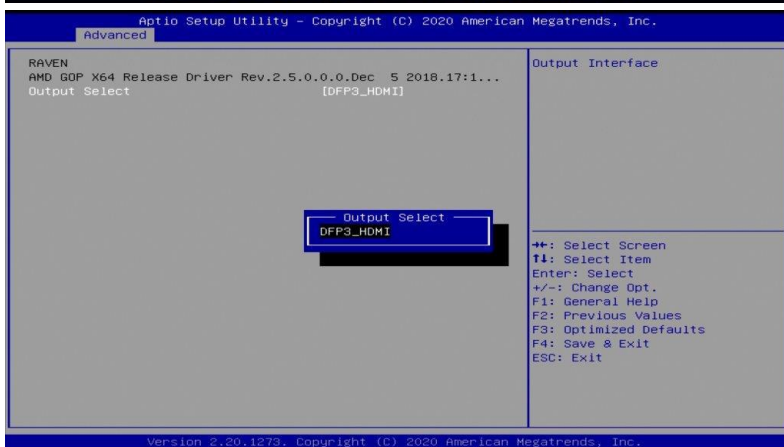
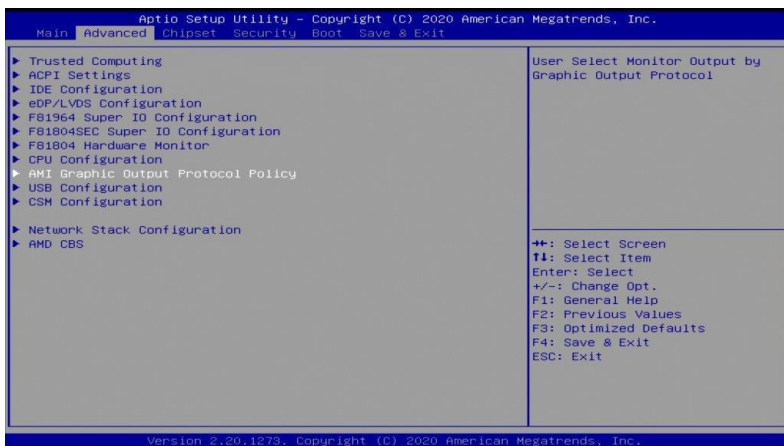

BIOS Setting	Description
Output Select	Allows you to select an output interface.

4.4.10 USB Configuration

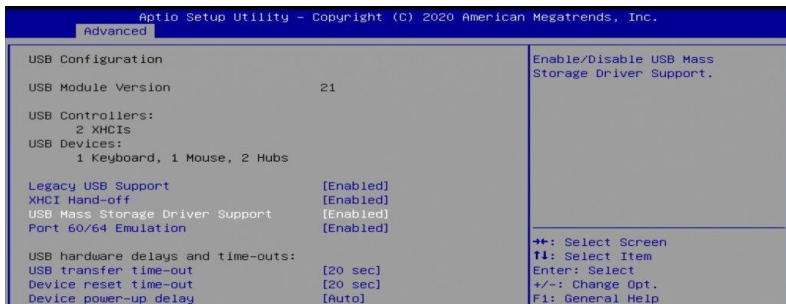
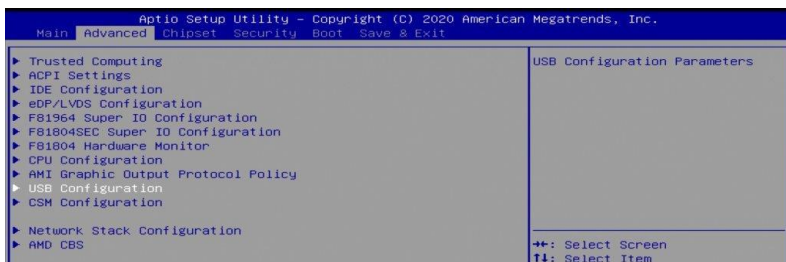

BIOS Setting	Description
Legacy USB Support	<p>Enables Legacy USB support.</p> <ul style="list-style-type: none"> • Auto disables legacy support if there is no USB device connected. • Disable keeps USB devices available only for EFI applications.
XHCI Hand-off	<p>This is a workaround for OSeS without XHCI hand-off support. The XHCI ownership change should be claimed by XHCI driver.</p>
USB Mass Storage Driver Support	<p>Enables / Disables the support for USB mass storage driver.</p>
USB Transfer time-out	<p>The time-out value for control, bulk, and Interrupt transfers. Options: 1 sec / 5 sec / 10 sec / 20 sec</p>
Device reset time-out	<p>Seconds of delaying execution of start unit command to USB mass storage device. Options: 10 sec / 20 sec / 30 sec / 40 sec</p>
Device power-up delay	<p>The maximum time the device will take before it properly reports itself to the Host Controller. Auto uses default value for a Root port it is 100ms. But for a Hub port, the delay is taken from Hub descriptor. Options: Auto / Manual</p>

4.4.11 CSM Configuration

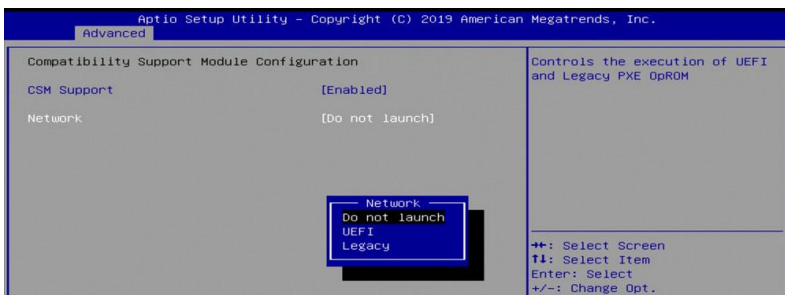
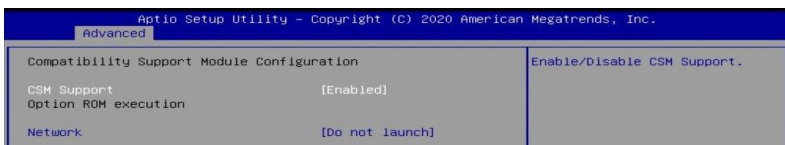
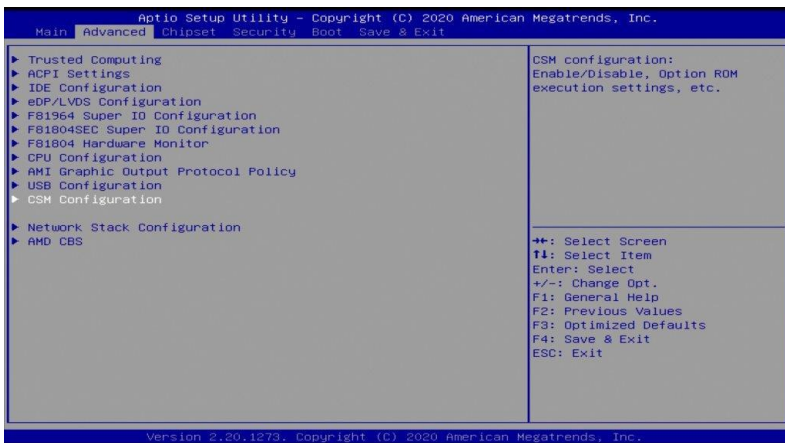

BIOS Setting	Description
CSM Support	Enables / Disables CSM support.
Network	Controls the execution of UEFI and Legacy PXE OpROM. Options: Do not launch / Legacy

4.4.12 Network Stack Configuration

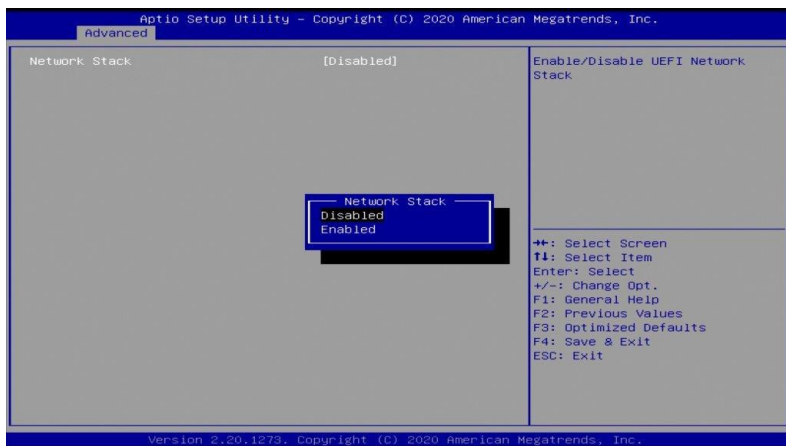
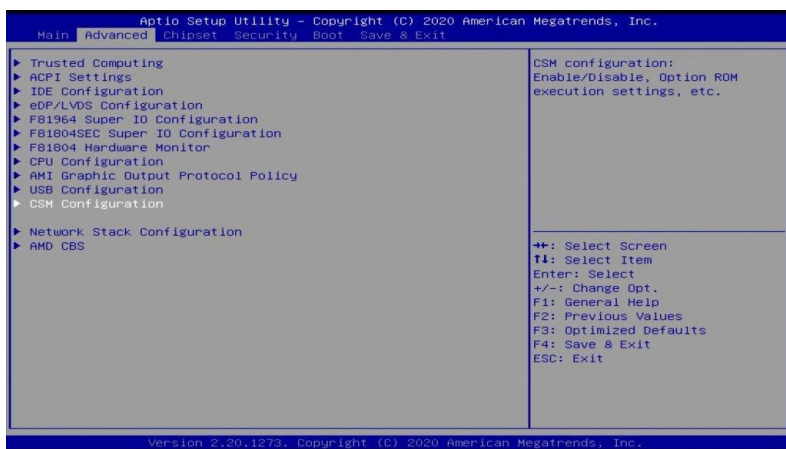

BIOS Setting	Description
Network Stack	Enables / Disables UEFI Network Stack.

4.4.13 AMD CBS

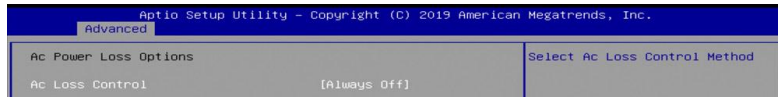
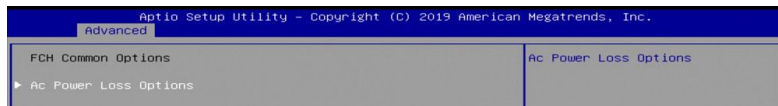
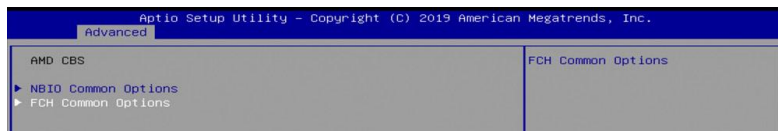
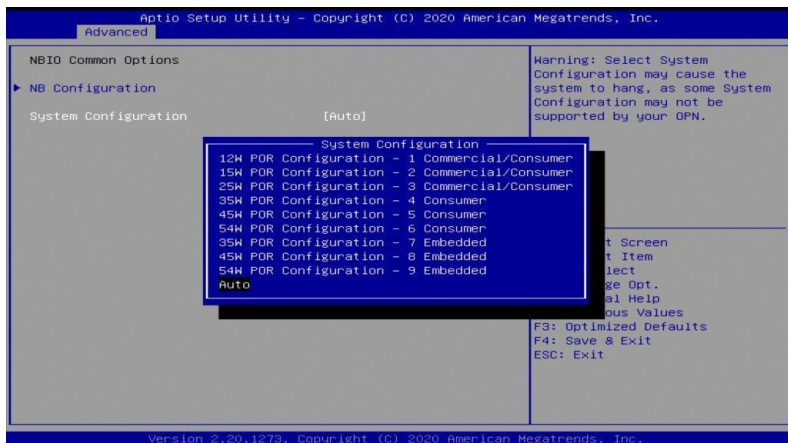
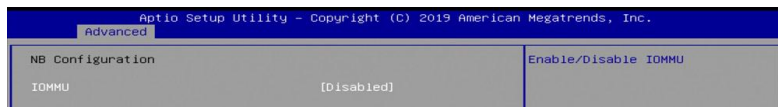
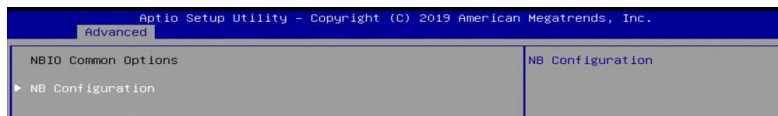
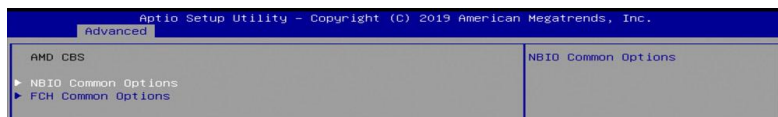

4.5 Chipset Settings

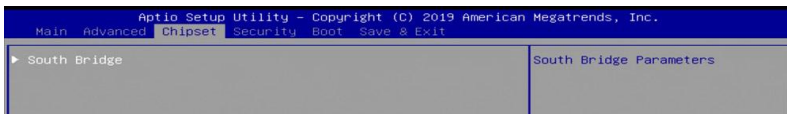

4.5.1 SB USB Configuration

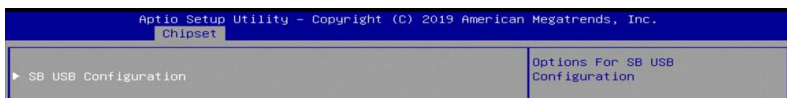

BIOS Setting	Description
SB USB Configuration	Options for SB USB Configuration.

4.5.1.1. XHCI Ports

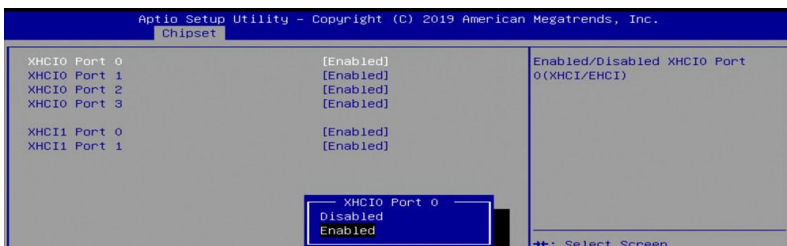

BIOS Setting	Description
XHCI 0 & XHCI 1 Ports	Enables / Disables the XHCI0 & XHCI1 ports (XHCI/EMCI).

4.6 Security Settings

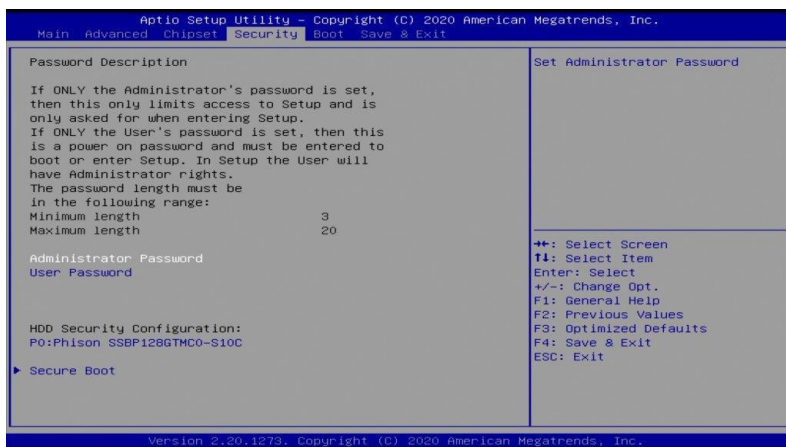

BIOS Setting	Description
Administrator Password	Sets an administrator password for the setup utility.
User Password	Sets a user password.
Secure Boot	Customizable Secure Boot

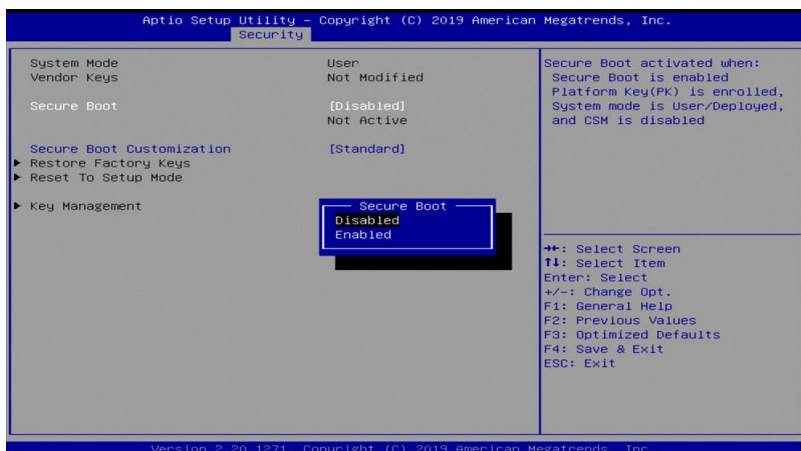

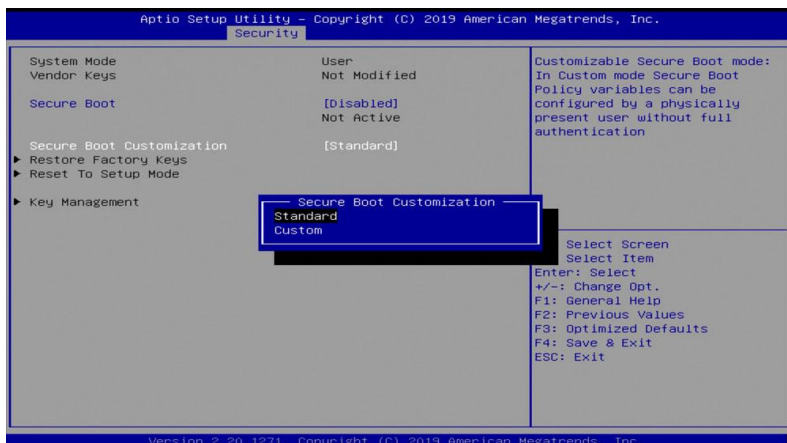

BIOS Setting	Description
Secure Boot	Secure Boot activated when: Secure Boot is enabled Platform Key(PK) is enrooled, System mode is user/deployed, and CSM is disabled
Secure Boot Customization	Customizable Secure Boot mode: In Custom mode, Secure Boot Policy Variables can be configured by a physically present user without full authentication.

4.7 Boot Settings

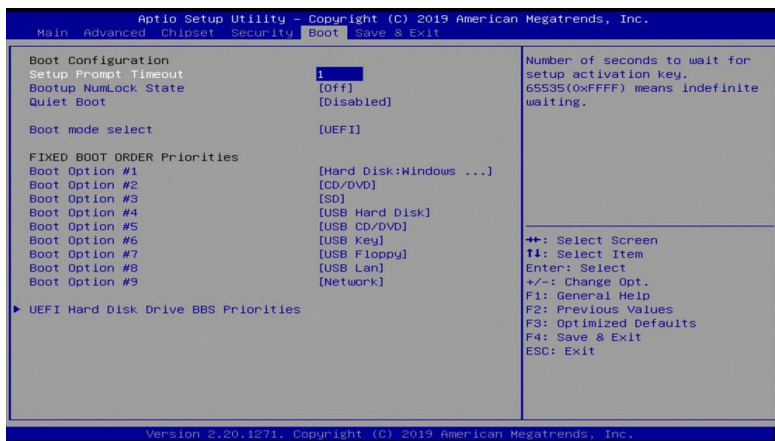

BIOS Setting	Description
Setup Prompt Timeout	Number of seconds to wait for setup activation key. 65535(0xFFFF) means indefinite waiting.
Bootup NumLock State	Selects the keyboard NumLock state.
Quiet Boot	Enables / Disables Quiet Boot option.
Boot mode select	Selects a Boot mode, Legacy / UEFI.
Boot Option Priorities	Sets the system boot order.
UEFI Hard Disk Drive BBS Priorities	Specifies the Boot Device Priority sequence from available UEFI Hard Disk Drivers.

4.8 Save & Exit

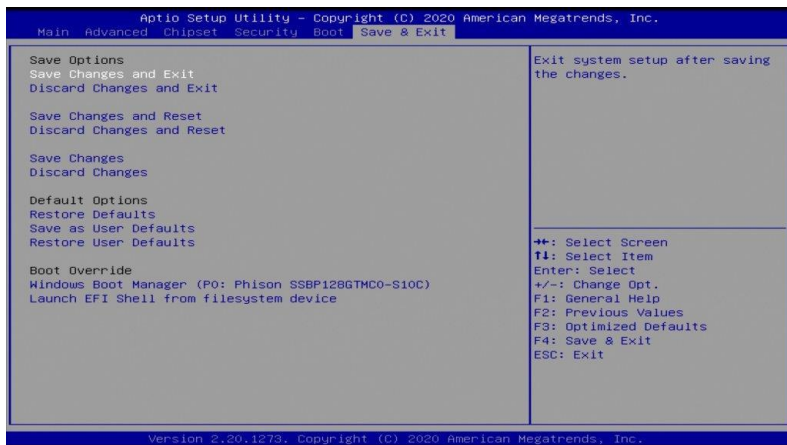

BIOS Setting	Description
Save Changes and Exit	Exit system setup after saving the changes.
Discard Changes and Exit	Exit system setup without saving any changes.
Save Changes and Reset	Resets the system after saving the changes.
Discard Changes and Reset	Reset system setup without saving any changes.
Save Changes	Save changes done so far to any of the setup options.
Discard Changes	Discard changes done so far to any of the setup options.
Restore Defaults	Restore / Loads defaults values for all the setup options.
Save as User Defaults	Save the changes done so far as User Defaults.
Restore User Defaults	Restore the user defaults to all the setup options.
Launch EFI Shell from filesystem device	Attempts to launch EFI Shell application (Shell.efi) from one of the available filesystem devices

Appendix

This section provides the mapping addresses of peripheral devices and the sample code of watchdog timer configuration.

A. I/O Port Address Map

Each peripheral device in the system is assigned a set of I/O port addresses which also becomes the identity of the device. The following table lists the I/O port addresses used.

Address	Device Description
0x00000A00-0x00000A0F	Motherboard resources
0x00000A10-0x00000A1F	Motherboard resources
0x00000A20-0x00000A2F	Motherboard resources
0x00000378-0x0000037F	Printer Port (LPT1)
0x00000070-0x00000071	System CMOS/real time clock
0x0000D000-0x0000DFFF	PCI Express Root Port
0x0000D000-0x0000DFFF	AMD Radeon(TM) Vega 11 Graphics
0x000003F8-0x000003FF	Communications Port (COM1)
0x000002F8-0x000002FF	Communications Port (COM2)
0x000003E8-0x000003EF	Communications Port (COM3)
0x000002E8-0x000002EF	Communications Port (COM4)
0x00000020-0x00000021	Programmable interrupt controller
0x000000A0-0x000000A1	Programmable interrupt controller
0x00000000-0x000003AF	PCI Express Root Complex
0x00000000-0x000003AF	Direct memory access controller
0x000003E0-0x00000CF7	PCI Express Root Complex
0x000003B0-0x000003DF	PCI Express Root Complex
0x0000D000-0x0000FFFF	PCI Express Root Complex
0x0000F000-0x0000FFFF	PCI Express Root Port
0x0000E000-0x0000EFFF	PCI Express Root Port
0x0000E000-0x0000EFFF	PCI Express Upstream Switch Port
0x0000E000-0x0000EFFF	PCI Express Downstream Switch Port
0x00000040-0x00000043	System timer
0x00000010-0x0000001F	Motherboard resources

0x00000022-0x0000003F	Motherboard resources
0x00000063-0x00000063	Motherboard resources
0x00000065-0x00000065	Motherboard resources
0x00000067-0x0000006F	Motherboard resources
0x00000072-0x0000007F	Motherboard resources
0x00000080-0x00000080	Motherboard resources
0x00000084-0x00000086	Motherboard resources
0x00000088-0x00000088	Motherboard resources
0x0000008C-0x0000008E	Motherboard resources
0x00000090-0x0000009F	Motherboard resources
0x000000A2-0x000000BF	Motherboard resources
0x000000B1-0x000000B1	Motherboard resources
0x000000E0-0x000000EF	Motherboard resources
0x000004D0-0x000004D1	Motherboard resources
0x0000040B-0x0000040B	Motherboard resources
0x000004D6-0x000004D6	Motherboard resources
0x00000C00-0x00000C01	Motherboard resources
0x00000C14-0x00000C14	Motherboard resources
0x00000C50-0x00000C51	Motherboard resources
0x00000C52-0x00000C52	Motherboard resources
0x00000C6C-0x00000C6C	Motherboard resources
0x00000C6F-0x00000C6F	Motherboard resources
0x00000CD0-0x00000CD1	Motherboard resources
0x00000CD2-0x00000CD3	Motherboard resources
0x00000CD4-0x00000CD5	Motherboard resources
0x00000CD6-0x00000CD7	Motherboard resources
0x00000CD8-0x00000CDF	Motherboard resources
0x00000800-0x0000089F	Motherboard resources
0x00000B00-0x00000B0F	Motherboard resources
0x00000B20-0x00000B3F	Motherboard resources
0x00000900-0x0000090F	Motherboard resources
0x00000910-0x0000091F	Motherboard resources

0x00000061-0x00000061	System speaker
0x00000081-0x00000083	Direct memory access controller
0x00000087-0x00000087	Direct memory access controller
0x00000089-0x0000008B	Direct memory access controller
0x0000008F-0x0000008F	Direct memory access controller
0x000000C0-0x000000DF	Direct memory access controller
0x00000A00-0x00000A0F	Motherboard resources
0x00000A10-0x00000A1F	Motherboard resources
0x00000A20-0x00000A2F	Motherboard resources
0x00000378-0x0000037F	Printer Port (LPT1)
0x00000070-0x00000071	System CMOS/real time clock
0x0000D000-0x0000DFFF	PCI Express Root Port
0x0000D000-0x0000DFFF	AMD Radeon(TM) Vega 11 Graphics
0x000003F8-0x000003FF	Communications Port (COM1)
0x000002F8-0x000002FF	Communications Port (COM2)
0x000003E8-0x000003EF	Communications Port (COM3)
0x000002E8-0x000002EF	Communications Port (COM4)
0x00000020-0x00000021	Programmable interrupt controller
0x000000A0-0x000000A1	Programmable interrupt controller
0x00000000-0x000003AF	PCI Express Root Complex
0x00000000-0x000003AF	Direct memory access controller
0x000003E0-0x00000CF7	PCI Express Root Complex
0x000003B0-0x000003DF	PCI Express Root Complex
0x00000D00-0x0000FFFF	PCI Express Root Complex
0x0000F000-0x0000FFFF	PCI Express Root Port
0x0000E000-0x0000EFFF	PCI Express Root Port
0x0000E000-0x0000EFFF	PCI Express Upstream Switch Port
0x0000E000-0x0000EFFF	PCI Express Downstream Switch Port

B. Interrupt Request Lines (IRQ)

Peripheral devices use interrupt request lines to notify CPU for the service required. The following table shows the IRQ used by the devices on board.

Level	Function
IRQ 0	High precision event timer
IRQ 3	Communications Port (COM2)
IRQ 4	Communications Port (COM1)
IRQ 6	Communications Port (COM3)
IRQ 7	AMD GPIO Controller
IRQ 8	High precision event timer
IRQ 10	Communications Port (COM4)
IRQ 14	AMD I2C Controller
IRQ 53	AMD Audio CoProcessor High Definition Audio Controller
IRQ 54	High Definition Audio Controller
IRQ 55	AMD SFH KMDf I2C
IRQ 55 ~ IRQ 511	Microsoft ACPI-Compliant System
IRQ 4294967256 ~ 4294967267	Intel(R) I210 Gigabit Network Connection #2
IRQ 4294967292	PCI Express Root Port
IRQ 4294967272~7	Intel(R) I211 Gigabit Network Connection
IRQ 4294967261~ 4294967268	AMD USB 3.10 eXtensible Host Controller - 1.10 (Microsoft)
IRQ 4294967291~94	PCI Express Root Port
IRQ 4294967286	Standard SATA AHCI Controller
IRQ 4294967287~90	PCI Express Downstream Switch Port
IRQ 4294967253~55	AMD Radeon(TM) Vega 11 Graphics
IRQ 4294967268~ 4294967283	AMD USB 3.10 eXtensible Host Controller - 1.10 (Microsoft)
IRQ 4294967288	PCI Express Downstream Switch Port
IRQ 4294967284~ 4294967285	AMD PSP 10.0 Device

C. Watchdog Timer Configuration

The Watchdog Timer (WDT) is used to generate a variety of output signals after a user programmable count. The WDT is suitable for use in the prevention of system lock-up, such as when software becomes trapped in a deadlock. Under these sorts of circumstances, the timer will count to zero and the selected outputs will be driven.

Under normal circumstance, you will need to restart the WDT at regular intervals before the timer counts to zero.

* F81804 WDT Main Function Example *

```
INTN
EFIAPI
ShellAppMain (
    IN UINTN Argc,
    IN CHAR16 **Argv
)
{
    int time = 10; //seconds

    if(!F81804Init()){ //Check if this SIO is F81804
        return 0;
    }
    F81804WdtEnable(time);
    //F81804WdtDisable();
}
```

* F81804 DIO Main Function Example

*

```
INTN
EFIAPI
ShellAppMain (
    IN UINTN Argc,
    IN CHAR16 **Argv
)
{
    UINT8 DIO;

    F8104EnterConfig();

    if(!F81804Init()){ //Check if this SIO is F81804
        return 0;
    }

    F81804DioInit(); //Init F81804 DIO

    F81804SetOutput(0x00); //Set out0-3 to Low
    DIO = F81804GetInput();
    if(DIO != 0x00){
        return 0;
    }

    F81804SetOutput(0x1E); //Set out0-3 to High
    DIO = F81804GetInput();
    if(DIO != 0x0F){
        return 0;
    }
}
```

* **F81804 Related Function Define and Implement** *

```

#define F81804_CONFIG_INDEX      0x2E
#define F81804_CONFIG_DATA      F81804_CONFIG_INDEX+1
#define F81804_CONFIG_MODE_ENTER_VALUE 0x87
#define F81804_CONFIG_MODE_EXIT_VALUE 0xAA

//Set F81804 out0-3 (BIT0: out0, BIT1: out1, BIT2: out2, BIT3: out3)
VOID F81804SetOutput(UINT8 Data){
    F8104ProgramRegister(0x07, 0x00, 0x06);
    F8104ProgramRegister(0x99, 0xE1, Data);
}

//Get F81804 into-3 (BIT0: in0, BIT1: in1, BIT2: in2, BIT3: in3)
UINT8 F81804GetInput(){
    UINT8 tmp1, tmp2, input;
    F8104ProgramRegister(0x07, 0x00, 0x06);

    IoWrite8(F81804_CONFIG_INDEX, 0xF2);
    tmp1 = IoRead8(F81804_CONFIG_DATA);
    tmp1 = tmp1 & 0x11; //BIT0: GPIO_STS BIT1: GPI1_STS
    IoWrite8(F81804_CONFIG_INDEX, 0xE2);
    tmp2 = IoRead8(F81804_CONFIG_DATA);
    tmp2 = tmp2 & 0xC0; //BIT6: GPI2_STS BIT7:GPI3_STS

    input = (tmp1 & 0x1) |
            ((tmp1 & 0x10) >> 3) |
            ((tmp2 & 0x40) >> 4) |
            ((tmp2 & 0x80) >> 4);

    return  input;
}

//Check if CHIP_ID for F81804
UINT8 F81804Init(){
    UINT8 CHIP_ID1, CHIP_ID2;
    IoWrite8(F81804_CONFIG_INDEX, 0x20);
    CHIP_ID1 = IoRead8(F81804_CONFIG_DATA);
    IoWrite8(F81804_CONFIG_INDEX, 0x21);
    CHIP_ID2 = IoRead8(F81804_CONFIG_DATA);

    if((CHIP_ID1 != 0x15) && (CHIP_ID2 != 0x02))
        return 0;
}

```



```

        return 1;
    }

//Program related DIO settings
VOID F81804DioInit(){

    F8104ProgramRegister(0x27, 0xF2, 0x00); //Set GPIO00, GPIO04 default input
    F8104ProgramRegister(0x2C, 0xEE, 0x11);
        F8104ProgramRegister(0x27, 0xF2, 0x0C); //Set GPIO16, GPIO17 default
input
        F8104ProgramRegister(0x2A, 0x88, 0);
    F8104ProgramRegister(0x07, 0x00, 0x06); //LDN=0x06
    F8104ProgramRegister(0x30, 0xFE, 0x01);
    F8104ProgramRegister(0xF0, 0xEE, 0);
    F8104ProgramRegister(0xE0, 0x3F, 0);

    F8104ProgramRegister(0x27, 0xF2, 0x0C); //GPIO91-94, Output enable and
default high
    F8104ProgramRegister(0x2C, 0xE1, 0x1E);
    F8104ProgramRegister(0x98, 0xE1, 0x1E);
}

VOID F8104ProgramRegister(
    UINT8 Register,
    UINT8 AndData,
    UINT8 OrData){

    UINT8 temp;

    IoWrite8(F81804_CONFIG_INDEX, Register);
    temp = IoRead8(F81804_CONFIG_DATA);

    temp &= AndData;
    temp |= OrData;
    IoWrite8(F81804_CONFIG_DATA, temp);
}

VOID F8104EnterConfig(){
    IoWrite8(F81804_CONFIG_INDEX,
F81804_CONFIG_MODE_ENTER_VALUE);
    IoWrite8(F81804_CONFIG_INDEX,
F81804_CONFIG_MODE_ENTER_VALUE);
}
VOID F8104ExitConfig(){
    IoWrite8(F81804_CONFIG_INDEX, F81804_CONFIG_MODE_EXIT_VALUE);
}

```

```
//Disable F81804 WDT
void F81804WdtDisable(){
    F8104EnterConfig();
    F8104ProgramRegister(0x07, 0x00, 0x07);
    F8104ProgramRegister(0x30, 0x00, 0x00);
    F8104ProgramRegister(0xF5, 0xF0, 0x52); //count mode is second
    F8104ProgramRegister(0xF6, 0x00, 0xFF); //set timer 0xFF seconds
    F8104ProgramRegister(0xFA, 0xFE, 0x00); //Disable WDTO output
    F8104ProgramRegister(0xF5, 0xDF, 0x00); //start counting
    F8104ExitConfig();
}
```

```
//Enable F81804 WDT
void F81804WdtEnable(UINT8 time){
    F8104EnterConfig();
    F8104ProgramRegister(0x27, ~(BIT3|BIT2|BIT0), BIT3);
    F8104ProgramRegister(0x2A, ~(BIT4|BIT5|BIT6), (BIT5|BIT6));
    F8104ProgramRegister(0x07, 0x00, 0x07);
    F8104ProgramRegister(0x30, 0x00, 0x01);
    F8104ProgramRegister(0xF5, 0xF0, 0x52); //count mode is second
    F8104ProgramRegister(0xF6, 0x00, time); //set timer time seconds
    F8104ProgramRegister(0xFA, 0xFE, 0x01); //enable WDTO output
    F8104ProgramRegister(0xF5, 0xFF, 0x20); //start counting
    F8104ExitConfig();
}
```

Our company network supports you worldwide with offices in Germany, Austria, Switzerland, the UK and the USA. For more information please contact:

Headquarters

Germany



FORTEC Elektronik AG

Augsburger Str. 2b
82110 Germering

Phone: +49 89 894450-0
E-Mail: info@fortecag.de
Internet: www.fortecag.de

Fortec Group Members

Austria



Distec GmbH Office Vienna

Nuschinggasse 12
1230 Wien

Phone: +43 1 8673492-0
E-Mail: info@distec.de
Internet: www.distec.de

Germany



Distec GmbH

Augsburger Str. 2b
82110 Germering

Phone: +49 89 894363-0
E-Mail: info@distec.de
Internet: www.distec.de

Switzerland



ALTRAC AG

Bahnhofstraße 3
5436 Würenlos

Phone: +41 44 7446111
E-Mail: info@altrac.ch
Internet: www.altrac.ch

United Kingdom



Display Technology Ltd.

Osprey House, 1 Osprey Court
Hichingbrooke Business Park
Huntingdon, Cambridgeshire, PE29 6FN

Phone: +44 1480 411600
E-Mail: info@displaytechnology.co.uk
Internet: www.displaytechnology.co.uk

USA



Apollo Display Technologies, Corp.

87 Raynor Avenue,
Unit 1 Ronkonkoma,
NY 11779

Phone: +1 631 5804360
E-Mail: info@apolloDisplays.com
Internet: www.apolloDisplays.com