



OUR GLOBAL
COMPETENCE
CENTRES

 APOLLO DISPLAY
TECHNOLOGIES



 DISTEC



 DISPLAY
TECHNOLOGY



Manual

Advantech

SOM-5871

**COM Express™ Basic Type 6 R3.0 Module with AMD Ryzen CPU
Processor Family**



User Manual

SOM-5871

COM Express Basic Module

ADVANTECH

Enabling an Intelligent Planet

Copyright

The documentation and the software included with this product are copyrighted 2019 by Advantech Co., Ltd. All rights are reserved. Advantech Co., Ltd. reserves the right to make improvements in the products described in this manual at any time without notice. No part of this manual may be reproduced, copied, translated or transmitted in any form or by any means without the prior written permission of Advantech Co., Ltd. Information provided in this manual is intended to be accurate and reliable. However, Advantech Co., Ltd. assumes no responsibility for its use, nor for any infringements of the rights of third parties, which may result from its use.

Acknowledgements

AMD are trademarks of AMD Corporation.

Microsoft Windows and MS-DOS are registered trademarks of Microsoft Corp.

All other product names or trademarks are properties of their respective owners.

Product Warranty (2 years)

Advantech warrants to you, the original purchaser, that each of its products will be free from defects in materials and workmanship for two years from the date of purchase.

This warranty does not apply to any products which have been repaired or altered by persons other than repair personnel authorized by Advantech, or which have been subject to misuse, abuse, accident or improper installation. Advantech assumes no liability under the terms of this warranty as a consequence of such events.

Because of Advantech's high quality-control standards and rigorous testing, most of our customers never need to use our repair service. If an Advantech product is defective, it will be repaired or replaced at no charge during the warranty period. For out-of-warranty repairs, you will be billed according to the cost of replacement materials, service time and freight. Please consult your dealer for more details.

If you think you have a defective product, follow these steps:

1. Collect all the information about the problem encountered. (For example, CPU speed, Advantech products used, other hardware and software used, etc.) Note anything abnormal and list any onscreen messages you get when the problem occurs.
2. Call your dealer and describe the problem. Please have your manual, product, and any helpful information readily available.
3. If your product is diagnosed as defective, obtain an RMA (return merchandise authorization) number from your dealer. This allows us to process your return more quickly.
4. Carefully pack the defective product, a fully-completed Repair and Replacement Order Card and a photocopy proof of purchase date (such as your sales receipt) in a shippable container. A product returned without proof of the purchase date is not eligible for warranty service.
5. Write the RMA number visibly on the outside of the package and ship it prepaid to your dealer.

Declaration of Conformity

CE

This product has passed the CE test for environmental specifications. Test conditions for passing included the equipment being operated within an industrial enclosure. In order to protect the product from being damaged by ESD (Electrostatic Discharge) and EMI leakage, we strongly recommend the use of CE-compliant industrial enclosure products.

FCC Class B

Note: This equipment has been tested and found to comply with the limits for a Class B digital device, pursuant to part 15 of the FCC Rules. These limits are designed to provide reasonable protection against harmful interference in a residential installation. This equipment generates, uses and can radiate radio frequency energy and, if not installed and used in accordance with the instructions, may cause harmful interference to radio communications. However, there is no guarantee that interference will not occur in a particular installation. If this equipment does cause harmful interference to radio or television reception, which can be determined by turning the equipment off and on, the user is encouraged to try to correct the interference by one or more of the following measures:

- Reorient or relocate the receiving antenna.
- Increase the separation between the equipment and receiver.
- Connect the equipment into an outlet on a circuit different from that to which the receiver is connected.
- Consult the dealer or an experienced radio/TV technician for help.

FM

This equipment has passed the FM certification. According to the National Fire Protection Association, work sites are classified into different classes, divisions and groups, based on hazard considerations. This equipment is compliant with the specifications of Class I, Division 2, Groups A, B, C and D indoor hazards.

Technical Support and Assistance

1. Visit the Advantech website at <http://support.advantech.com> where you can find the latest information about the product.
2. Contact your distributor, sales representative, or Advantech's customer service center for technical support if you need additional assistance. Please have the following information ready before you call:
 - Product name and serial number
 - Description of your peripheral attachments
 - Description of your software (operating system, version, application software, etc.)
 - A complete description of the problem
 - The exact wording of any error messages

Warnings, Cautions and Notes

Warning! Warnings indicate conditions, which if not observed, can cause personal injury!



Caution! Cautions are included to help you avoid damaging hardware or losing data. e.g.



There is a danger of a new battery exploding if it is incorrectly installed. Do not attempt to recharge, force open, or heat the battery. Replace the battery only with the same or equivalent type recommended by the manufacturer. Discard used batteries according to the manufacturer's instructions.

Note! Notes provide optional additional information.



Document Feedback

To assist us in making improvements to this manual, we would welcome comments and constructive criticism. Please send all such - in writing to: support@advan-tech.com

Safety Instructions

1. Read these safety instructions carefully.
2. Keep this User Manual for later reference.
3. Disconnect this equipment from any AC outlet before cleaning. Use a damp cloth. Do not use liquid or spray detergents for cleaning.
4. For plug-in equipment, the power outlet socket must be located near the equipment and must be easily accessible.
5. Keep this equipment away from humidity.
6. Put this equipment on a reliable surface during installation. Dropping it or letting it fall may cause damage.
7. The openings on the enclosure are for air convection. Protect the equipment from overheating. **DO NOT COVER THE OPENINGS.**
8. Make sure the voltage of the power source is correct before connecting the equipment to the power outlet.
9. Position the power cord so that people cannot step on it. Do not place anything over the power cord.
10. All cautions and warnings on the equipment should be noted.
11. If the equipment is not used for a long time, disconnect it from the power source to avoid damage by transient overvoltage.
12. Never pour any liquid into an opening. This may cause fire or electrical shock.
13. Never open the equipment. For safety reasons, the equipment should be opened only by qualified service personnel.
14. If one of the following situations arises, get the equipment checked by service personnel:
 - The power cord or plug is damaged.
 - Liquid has penetrated into the equipment.
 - The equipment has been exposed to moisture.
 - The equipment does not work well, or you cannot get it to work according to the user's manual.
 - The equipment has been dropped and damaged.
 - The equipment has obvious signs of breakage.
15. **DO NOT LEAVE THIS EQUIPMENT IN AN ENVIRONMENT WHERE THE STORAGE TEMPERATURE MAY GO BELOW -20° C (-4° F) OR ABOVE 60° C (140° F). THIS COULD DAMAGE THE EQUIPMENT. THE EQUIPMENT SHOULD BE IN A CONTROLLED ENVIRONMENT.**
16. **CAUTION: DANGER OF EXPLOSION IF BATTERY IS INCORRECTLY REPLACED. REPLACE ONLY WITH THE SAME OR EQUIVALENT TYPE RECOMMENDED BY THE MANUFACTURER, DISCARD USED BATTERIES ACCORDING TO THE MANUFACTURER'S INSTRUCTIONS.**

The sound pressure level at the operator's position according to IEC 704-1:1982 is no more than 70 dB (A).

DISCLAIMER: This set of instructions is given according to IEC 704-1. Advantech disclaims all responsibility for the accuracy of any statements contained herein.

Safety Precaution - Static Electricity

Follow these simple precautions to protect yourself from harm and the products from damage.

- To avoid electrical shock, always disconnect the power from your PC chassis before you work on it. Don't touch any components on the CPU card or other cards while the PC is on.
- Disconnect power before making any configuration changes. The sudden rush of power as you connect a jumper or install a card may damage sensitive electronic components.

Contents

Chapter 1	General Information	1
1.1	Introduction	2
1.2	Functional Block Diagram	4
1.3	Product Specification	5
1.3.1	Compliance	5
1.3.2	Feature List	5
1.3.3	Processor System	6
1.3.4	Memory	6
1.3.5	Graphics/Audio	7
1.3.6	Displays	7
1.3.7	Expansion Interface	8
1.3.8	LPC	9
1.3.9	Serial Bus	9
1.3.10	I/O	9
1.3.11	Power Management	11
1.3.12	Environment	12
1.3.13	MTBF	12
1.3.14	OS Support (duplicate with SW chapter)	12
1.3.15	Advantech iManager	12
1.3.16	Power Consumption	13
1.3.17	Performance	13
1.3.18	Selection Guide w/ P/N	13
1.3.19	Packing list	13
1.3.20	Development Board	14
1.3.21	Pin Description	14
Chapter 2	Mechanical Information	15
2.1	Board Information	16
	Figure 2.1 Board chips identification – Front	16
	Figure 2.2 Board chips identification – Rear	16
2.1.1	Connector List	17
	Table 2.1: FAN1 Fan	17
2.2	Mechanical Drawing	17
	Figure 2.3 Board Mechanical Drawing – Front	17
	Figure 2.4 Board Mechanical Drawing – Rear	18
	Figure 2.5 Board Mechanical Drawing – Side	18
2.3	Assembly Drawing	19
	Figure 2.6 Assembly Drawing	19
Chapter 3	AMI BIOS	21
3.1	Starting	22
3.1.1	Main Setup	23
3.1.2	Advanced BIOS Features Setup	25
3.1.3	Chipset	63
3.1.4	Security	70
3.1.5	Boot Settings	74
3.1.6	Save & Exit	75
Chapter 4	S/W Introduction & Installation	77

4.1	S/W Introduction	78
4.2	Driver Installation	78
4.2.1	Windows Driver Setup	78
4.2.2	Other OS.....	78
4.3	Advantech iManager	78
Appendix A	Pin Assignment.....	81
A.1	SOM-5871 Type 6 Pin Assignment.....	82
Appendix B	Watchdog Timer.....	87
B.1	Programming the Watchdog Timer	88
Appendix C	Programming GPIO.....	89
C.1	GPIO Register.....	90
Appendix D	System Assignments.....	91
D.1	System I/O Ports	92
	Table D.1: System I/O ports.....	92
D.2	DMA Channel Assignments	93
	Table D.2: DMA Channel Assignments	93
D.3	Interrupt Assignments	94
	Table D.3: Interrupt Assignments	94
D.4	1st MB Memory Map	95
	Table D.4: 1st MB Memory Map	95

Chapter 1

General Information

This chapter gives background information on the SOM-5871 CPU Computer on Module

Sections include:

- Introduction
- Functional Block Diagram
- Product Specification

1.1 Introduction

SOM-5871 is equipped with the latest and first 14nm AMD Ryzen™ Embedded V1000 Processor (12-54W TDP) with up to four cores and eight threads. The AMD "Zen" core micro-architecture on the new COM Express (PICMG COM.0) R3.0 Type 6 basic module provides high computing power, and advanced graphics performance. With the integration of the AMD Ryzen Embedded V1000, the SOM-5871 can offer an ideal balance of superior performance and low power consumption for Advantech customers.

Designed for High Graphic Performance Requirements

SOM-5871 uses up to 32GB of dual channel DDR4 3200 MT/s memory (both ECC and non-ECC) with higher memory bandwidth for better performance and efficiency. The new COM Express Basic module supports quad independent displays with VGA, LVDS, eDP, DisplayPort, HDMI, and HDR playback support. VP9 decode and H.265 (HEVC) hardware decode and encode as well as four 4K display outputs are supported by leveraging the AMD Ryzen Embedded V1000. The premium performance of the SOM-5871 drives 4K animation and content. SOM-5871 is built for use in demanding applications such as casino gaming, arcade gaming, digital signage, medical, industrial control, automation, thin clients, and communications infrastructure fields.

Optimized Solutions Extend Design Flexibility

SOM-5871 adopts 10/100/1000 Mbps speeds Ethernet controller and flexible I/O interface options with: 1 x PCIe4, 3 x PCIe1 through a PCIe Bridge, 2 x SATA Gen. 3 @ 6.0Gb/s, 3 x USB 3.0, 8 x USB 2.0 via USB Hub, 2 x COM ports (2-Wire), TPM 2.0, CAN Bus function (optional support), watchdog timer, and GPIO to fulfill a wide variety of functions and high performance system extension requirements. And for better structural integrity, SOM-5871 added an extra mounting hole design around the CPU for a stronger board structure that avoids board bending and improves thermal throughput to fulfill higher CPU TDP requirements.

Acronyms	
Term	Define
AC'97	Audio CODEC (Coder-Decoder)
ACPI	Advanced Configuration Power Interface - standard to implement power saving modes in PC-AT systems.
BIOS	Basic Input Output System - firmware in PC-AT system that is used to initialize system components before handing control over to the operating system.
CAN	Controller-area network (CAN or CAN-bus) is a vehicle bus standard designed to allow micro controllers to communicate with each other within a vehicle without a host computer.
DDI	Digital Display Interface - containing DisplayPort, HDMI/DVI, and SDVO
EAPI	<p>Embedded Application Programmable Interface Software interface for COM Express© specific industrial function</p> <ul style="list-style-type: none"> ■ System information ■ Watchdog timer ■ I2C Bus ■ Flat panel brightness control ■ User storage area ■ GPIO
GbE	Gigabit Ethernet
GPIO	General purpose input output
HDA	Intel High Definition Audio (HD Audio) refers to the specification released by Intel in 2004 for delivering high definition audio that is capable of playing back more channels at higher quality than AC'97
I2C	Inter Integrated Circuit - 2 wire (clock and data) signaling scheme allowing communication between integrated circuit, primarily used to read and load register values
ME	Management Engine
PC-AT	"Personal Computer - Advanced Technology" - an IBM trademark term used to refer to Intel based personal computer in 1990s
PEG	PCI Express Graphics
RTC	Real Time Clock - battery backed circuit in PC-AT systems that keeps system time and date as well as certain system setup parameters
SPD	Serial Presence Detect - refers to serial EEPROM on DRAMs that has DRAM Module configuration information
TPM	Trusted Platform Module, chip to enhance the security features of a computer system
UEFI	Unified Extensible Firmware Interface
WDT	Watch Dog Timer

1.2 Functional Block Diagram

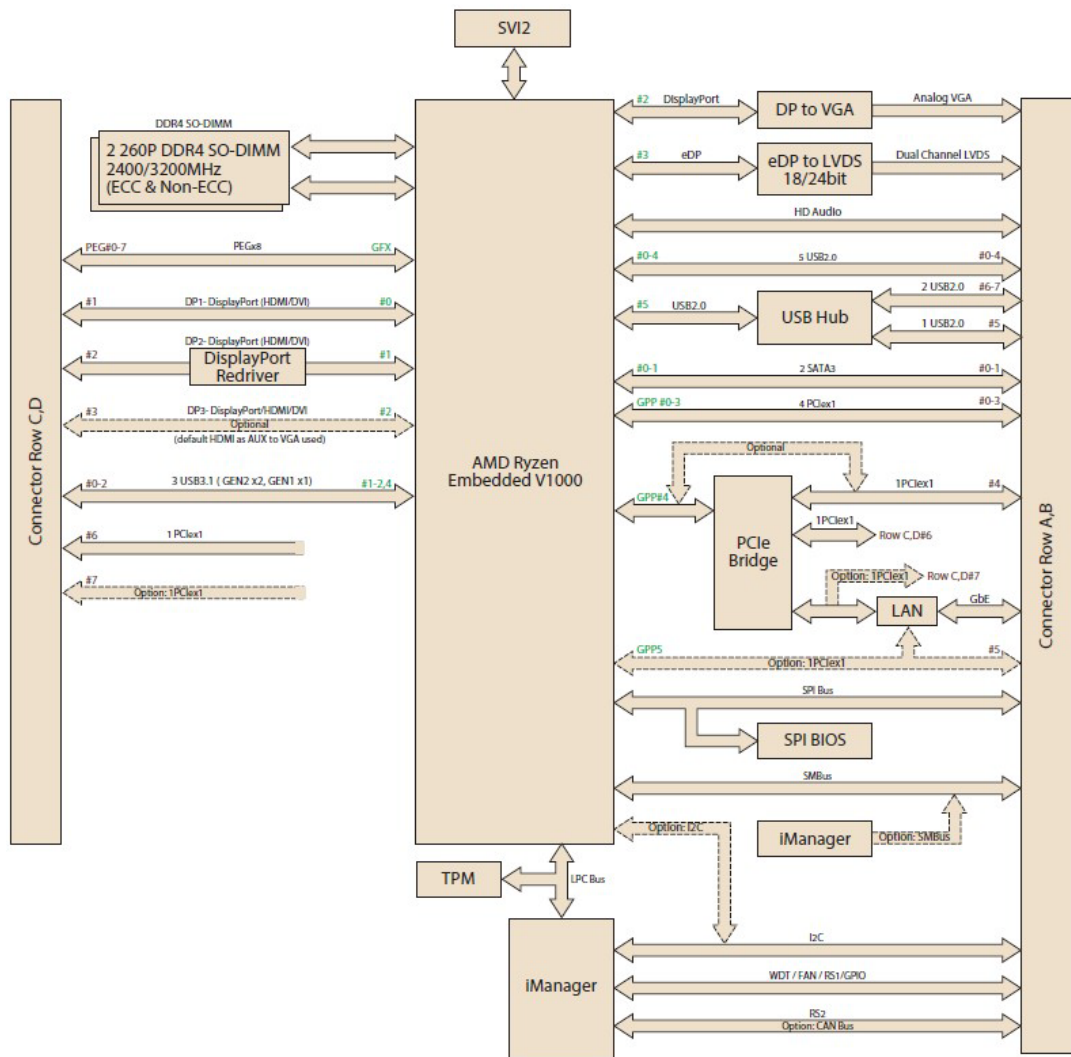

1.3 Product Specification

1.3.1 Compliance

- PICMG COM.0 (COM Express) Revision 3.0
- Basic Size - 125 x 95mm
- Pin-out Type 6 compatible

1.3.2 Feature List

A-B	System I/O	Rev.3.0 Type 6	SOM-5871
	PCI Express Lanes 0 - 5	1 / 6	6
	LVDS Channel A	0 / 1	1
	LVDS Channel B	0 / 1	1
	eDP on LVDS CH A Pins	0 / 1	1
	VGA Port	0 / 1	1
	TV-Out	N/A	N/A
	Digital Display Interface 0	N/A	N/A
	Serial Ports 1 - 2	0 / 2	2
	CAN Interfaces on SER1	0 / 1	1
	SATA / SAS Ports	1 / 4	2
	AC'97 / HDA Digital Interface	0 / 1	1
	USB 2.0 Ports (Host)	4 / 8	8
	USB Client 0 (USB2.0)	0 / 1	0
	USB Client 7(USB2.0)	N/A	N/A
	USB 3.0 Ports (Host)	N/A	N/A
	LAN Port 0	1 / 1	1
	Express Card Support	N/A	N/A
	LPC Bus /eSPI	1 / 1	1
	SPI	1 / 2	2
A-B	System Management	Rev.3.0 Type 6	SOM-5871 R3.0 Type 6
	SDIO (Muxed on GPIO)	0 / 1	0
	General Purpose I/O	8 / 8	8
	SMBus	1 / 1	1
	I2C	1 / 1	1
	Watchdog Timer	0 / 1	1
	Speaker Out	1 / 1	1
	External BIOS ROM Support	0 / 2	2
	Reset Function	1 / 1	1
A-B	Power Management	Rev.3.0 Type 6	SOM-5871 R3.0 Type 6
	Thermal Protection	0 / 1	1
	Battery Low Alarm	0 / 1	1
	Suspend / Wake Signals	0 / 3	3
	Power Button Support	1 / 1	1
	Power Good	1 / 1	1
	VCC_5V_SBY Contacts	4 / 4	4
	Sleep	0 / 1	1

	Lid Input	0 / 1	1
	Fan PWM / Tachometer	0 / 2	2
	Trusted Platform Modules	0 / 1	1
A-B	Power	Rev.3.0 Type 6	SOM-5871 R3.0 Type 6
	VCC_12V Contacts	12 / 12	12
C-D	System I/O	Rev.3.0 Type 6	SOM-5871 R3.0 Type 6
	PCI Express Lanes 16 - 31	0 / 16	N/A
	PCI Express Graphics (PEG)	0 / 1	1
	Muxed SDVO Channels 1 - 2	N/A	N/A
	PCI Express Lanes 6 - 15	0 / 2	2
	PCI Bus - 32 Bit	N/A	N/A
	PATA Port	N/A	N/A
	10G LAN Port 0 - 3	N/A	N/A
	NC-SI	N/A	N/A
	Digital Display Interfaces 1 - 3	0 / 3	2
	USB 3.0 Ports	0 / 4	3
C-D	Power	Rev.3.0 Type 6	SOM-5871 R3.0 Type 6
	VCC_12V Contacts	12 / 12	12

1.3.3 Processor System

CPU	Std. Freq.	Max. Turbo Freq.	Core/Thread	Cache (MB)	TDP Range (W)
V1807B	3.35GHz	3.8GHz	4/8	2M	35-54W
V1756B	3.25GHz	3.6GHz	4/8	2M	35-54W
V1605B	2.0GHz	3.6GHz	4/8	2M	12-25W
V1202B	2.3GHz	3.2GHz	2/4	2M	12-25W

1.3.4 Memory

There are a total of two sockets on SOM-5871, up to 32GB capacity. (Supports both non-ECC and ECC memory module).

- 2 DDR4 260pin SODIMM sockets.
- V1807B, V1756B CPU SKU support DDR4 up to 3200.
- V1605B, V1202B CPU SKU support DDR4 up to 2400.

FP5 Max DDR4 data rate

(Reference from AMD document)

APU TDP	Memory Rank	Number of DIMM Socket on Each Channel	Max Data Rate (MT/s)
Above 25W (V1807B, V1756B)	Single Rank	1	DDR4-3200
	Dual Rank	1	DDR4-2400
25W or Below (V1605B, V1202B)	Single Rank	1	DDR4-2400
	Dual Rank	1	DDR4-2400

1.3.5 Graphics/Audio

Supports 4 4K displays.

Graphic Core: "Vega" Core, up to 11 CUs, ACP3.0, up to 3 codecs, 1.8V for I2S, 1.2V, 1.5V, or 1.8V for AZ or Soundwire Direct audio I2S interface

CPU	Graphic Core	Max GPU Freq.	GPU CU
V1807B	Vega Core	1.3GHz	11
V1756B	Vega Core	1.1GHz	8
V1605B	Vega Core	1.1GHz	8
V1202B	Vega Core	1.0GHz	3

1.3.6 Displays

VGA: 1920 x 1200 @ 60 Hz

LCD: Dual channel 18/24-bit LVDS, up to 1920 x 1200 @ 60 Hz
Option support eDP1.4, up to 4096 x 2304 @ 60Hz, 24bpp

DDI: 2 x ports configurable to HDMI1.4/DVI/DisplayPort1.4 (Option: support 3 ports when VGA is removed)

HDMI up to 4096 x 2160 @ 30Hz, DVI up to 1920 x 1200 @ 60Hz, DisplayPort up to 3840 x 2160 @ 120Hz with re-driver; up to 3840 x 2160 @ 60Hz without re-driver.

Multiple Displays: Quad display with each display combination.

Theoretical Max SDR and HDR Resolution

(Reference from AMD document)

Maximum SDR Resolution (Clone/Extended mode) -Dual Channel

- 1 display: 2880p60 / 4320p30*
- 2 displays: 2880p60 / 4320p30*
- 3 displays: 2160p60
- 4 displays: 2160p60

Maximum SDR Resolution (Clone/Extended mode) -Single Channel

- 1 display: 2880p60 / 4320p30*
- 2 displays: 2160p60
- 3 displays: 1440p@60 / 2160p@30
- 4 displays: 1440p@60 / 2160p@30

Maximum HDR Resolution (Clone/Extended mode) -Dual Channel

- 2 displays: 2160p60
- 4 displays: 1440p60

Maximum HDR Resolution (Clone/Extended mode) -Single Channel

- 1 display: 2160p60
- 2 displays: 1440p60
- 4 displays: 1080p60

Note!



- Above maximum resolutions are applicable to V1807B
- This is just a statement about supported displays and not about multimedia streams
- *: V1000 45W OPNs are capable of 2880p60 / 4320p30, but only 2160p60 has been validated as these are the most readily available displays

1.3.7 Expansion Interface

PCI Express x8 -1 PEGx8

PCIe x1 - Several configurable combinations may need BIOS modifications. Please contact to Advantech sales or FAE for more details.

	Bridge [source from]	PCIex4 [COMe PCIe Port#]	PCIEx2 [COMe PCIe Port#]	PCIex1 [COMe PCIe Port#]	LAN [source from]	COMe	COMe	x1 speed
						Gen3 Port#	Gen2 Port#	
						(x1 speed: Gen3)	(x1 speed: Gen2)	
Config A (Default)	YES [AMD SoC GPP4]	0	0	6 [0,1,2,3,4,6]	YES [through bridge]	0,1,2,3	4,6	GEN3*4+ GEN2*2
Config B	YES [AMD SoC GPP4]	0	0	7 [0,1,2,3,4,6,7]	NO	0,1,2,3	4,6,7	GEN3*4+ GEN2*3
Config C	YES [AMD SoC GPP4]	0	1 [3:2] or [1:0]	5 [0,1,4,5,6] or [2,3,4,5,6]	YES [through bridge]	0,1,5 or 2,3,5	4,6	GEN3*3+ GEN2*2
Config E	YES [AMD SoC GPP4]	0	1 [3:2] or [1:0]	6 [0,1,4,5,6,7] or [2,3,4,5,6,7]	NO	0,1,5 or 2,3,5	4,6,7	GEN3*3+ GEN2*3
Config F	YES [AMD SoC GPP4]	0	2 [3:2] , [1:0]	3 [4,5,6]	YES [through bridge]	5	4,6	GEN3*1+ GEN2*2
Config H	YES [AMD SoC GPP4]	0	2 [3:2] , [1:0]	4 [4,5,6,7]	NO	5	4,6,7	GEN3*1+ GEN2*3
Config I (Optional)	YES [AMD SoC GPP4]	1 [3:0]	0	3 [4,5,6]	YES [through bridge]	5	4,6	GEN3*1+ GEN2*2
Config K	YES [AMD SoC GPP4]	1 [3:0]	0	4 [4,5,6,7]	NO	5	4,6,7	GEN3*1+ GEN2*3

Config L	NO	0	1 [5:4]	4 [0,1,2,3]	NO	0,1,2,3		GEN3
Config N	NO	0	1 [3:2] or [1:0]	3 [0,1,4] or [2,3,4]	YES [AMD SoC GPP5]	0,1,4 or 2,3,4		
Config O	NO	0	2 [3:2] , [1:0]	2 [4,5]	NO	4,5		
Config P	NO	0	2 [3:2] , [1:0]	1 [4]	YES [AMD SoC GPP5]	4		
Config Q	NO	1 [3:0]	0	2 [4,5]	NO	4,5		
Config R	NO	1 [3:0]	0	1 [4]	YES [AMD SoC GPP5]	4		
Config S	NO	1 [3:0]	1 [5:4]	0	NO			

1.3.8 LPC

Supports Low Pin Count (LPC) 1.1 specification, without DMA or bus mastering. Allows connection to Super I/O, embedded controller, or TPM. LPC clock is 33MHz.

1.3.9 Serial Bus

1.3.9.1 SMBus

Supports SMBus 2.0 specification with Alert pin.
Default from SoC; option from EC.

1.3.9.2 I2C Bus

Supports I2C bus 8-bit and 10-bit address modes, at both 100KHz and 400KHz.
Default from EC; option from SoC.

1.3.10 I/O

1.3.10.1 Gigabit Ethernet

Ethernet: Intel I210AT Gigabit LAN supports 10/100/1000 Mbps Speed.

1.3.10.2 SATA

Supports 2 ports SATA Gen3 (6.0 Gb/s), backward compliant to SATA Gen2 (3.0 Gb/s) and Gen1 (1.5 Gb/s). Maximum data rate is 600 MB/s. Supports AHCI 1.3 mode.

1.3.10.3 USB3.0 (3.1)/USB2.0

SOM-5871 supports 2 ports USB3.1 Gen2 (10 Gbps), 1 port USB 3.1 Gen1 (5 Gbps) and 8 ports USB 2.0 (480 Mbps) which are backward compatible to USB1.x. USB 3.1 supports LPM (U0, U1, U2, and U3) manageability to save power.

Note! To meet USB3.1 Gen2 performance, strongly recommend to use the certificated cable.



1.3.10.4 USB 3.1 Gen2

Type 6	P0	P1
SoC	P0	P1

1.3.10.5 USB 3.1 Gen1

Type 6	P2
SoC	P2

1.3.10.6 USB 2.0

Type 6	P0	P1	P2	P3	P4	P5	P6	P7
SoC	P0	P1	P2	P3	P4	P5	P6	P7
Type 6	OC_01		OC_23		OC_45		OC_67	
SoC USB_OC#	OC_01		OC_23		OC_45		OC_67	

1.3.10.7 SPI Bus

Supports BIOS flash only. SPI clock can be 50MHz, 33MHz, or 20MHz, capacity up to 16MB.

1.3.10.8 GPIO

8 x programmable general purpose Input or output (GPIO).

1.3.10.9 Watchdog

Supports multi-level watchdog time-out output. Provides 1-65535 level, from 100ms to 109.22 minutes interval.

1.3.10.10 Serial port

2 ports, 2-wire serial port (Tx/Rx) support 16550 UART compliance.

- Programmable FIFO or character mode.
- 16-byte FIFO buffer on transmitter and receiver in FIFO mode.
- Programmable serial-interface characteristics: 5, 6, 7, or 8-bit character.
- Even, odd, or no parity bit selectable.
- 1, 1.5, or 2 stop bit selectable.
- Baud rate up to 115.2K.

1.3.10.11 TPM

Supports TPM 2.0 module by default.

1.3.10.12 CAN Bus

Supports CAN Bus function as optional function by BOM change (co-layout with COM 2).

1.3.10.13 Smart Fan

Supports 2 Fan PWM control signal and 2 tachometer inputs for fan speed detection. Provides 1 on module with connector and the other on the carrier board following PICMG COM Express R3.0 specification.

1.3.10.14 BIOS

BIOS chip is on module by default. Also allows the user to place BIOS chip on the carrier board with appropriate design and jumper setting on BIOS_DIS#[1:0].

BIOS_DIS0#	BIOS_DIS#1	Boot up destination/function
Open	Open	Boot from Module's SPI BIOS
Open	GND	SPI_CS0# to Carrier Board, SPI_CS1# to Module
GND	GND	SPI_CS0# to Module, SPI_CS1# to Carrier Board

Note! *If system COMS are cleared, we strongly suggest to go to the BIOS setup menu and load default settings at the first time of boot up.*



1.3.11 Power Management

1.3.11.1 Power Supply

Supports both ATX and AT power modes. VSB is for suspend power and can be option if not require standby (suspend-to-RAM) support. RTC Battery may be option if keep time/date is not require.

VCC: 8.5V - 20V

VSB: 4.75V - 5.25V (Suspend power)

RTC Battery Power: 2.0V - 3.3V

1.3.11.2 PWROK

Power OK from main power supply. A high value indicates that the power is good. This signal can be used to hold off Module startup to allow Carrier based FPGAs or other configurable devices time to be programmed.

1.3.11.3 Power Sequence

According to PICMG COM Express R3.0 specification

1.3.11.4 Wake Event

Various wake-up events supporting allow user to apply into different scenario.

- Wake-on-LAN(WOL): Wake to S0 from S3/S4/S5
- USB Wake: Wake to S0 from S3/S4
- PCIe Device Wake: depends on user inquiry and may need customized BIOS
- LPC Wake: depends on user inquiry and may need customized BIOS

1.3.11.5 Advantech S5 ECO Mode (Deep Sleep Mode)

Advantech iManager provides additional features to allow the system to enter a very low suspend power mode - S5 ECO mode. In this mode, the module will cut all power including suspend and active power into the chipset and keep an on-module controller active. Therefore, only under 50mW of power will be consumed which means battery packs can last longer. While this mode is enabled in BIOS, the system (or module) only allows a power button to boot rather than others such as WOL.

1.3.12 Environment

1.3.12.1 Temperature

- Operating: 0 ~ 60° C (32 ~ 140° F), with an active heat sink under 0.7m/s air flow chamber
- Storage: -40 ~ 85° C (-40 ~ 185° F)

1.3.12.2 Humidity

- Operating: 40° C @ 95% relative humidity, non-condensing
- Storage: 60° C @ 95% relative humidity, non-condensing

1.3.12.3 Vibrations

IEC60068-2-64: Random vibration test under operation mode, 3.5Grms

1.3.12.4 Drop Test (Shock)

Federal Standard 101 Method 5007 test procedure with standard packing

1.3.12.5 EMC

CE EN55022 Class B and FCC Certifications: validate with standard development boards in Advantech chassis

1.3.13 MTBF

Please refer Advantech SOM-5871 Series Reliability Prediction Report No: TBD. (Estimated date: TBD)

1.3.14 OS Support (duplicate with SW chapter)

The mission of Advantech Embedded Software Services is to "Enhance quality of life with Advantech platforms and Microsoft Windows embedded technology." We enable Windows Embedded software products on Advantech platforms to more effectively support the embedded computing community. Customers are freed from the hassle of dealing with multiple vendors (Hardware suppliers, System integrators, Embedded OS distributor) for projects. Our goal is to make Windows Embedded Software solutions easily and widely available to the embedded computing community.

To install the drivers, please connect to internet and browse the website <http://support.advantech.com.tw> to download the setup file.

1.3.15 Advantech iManager

Supports APIs for GPIO, smart fan control, multi-stage watchdog timer and output, temperature sensor, hardware monitor, etc. They follow PICMG EAPI 1.0 specifications that provides backward compatibility.

1.3.16 Power Consumption

Power Consumption Table (Watt.)						
VCC=12V, VSB=5V	Active Power Domain			Suspend Power Domain		Mechanical off
Power State	S0 Max. Load	S0 Burn-in	S0 Idle	S5	S5 Deep Sleep	RTC (uA)
SOM-5871VC-H3A1	68.118W	39.9791W	7.3437W	0.8844W	0.4914W	4.69uA

Hardware Configurations:

- MB:** SOM-5871VC-H3A1 (PCB: A101-3)
- ADVANTECH 16GB SO-DDR4-2400 *2PCS**
- Carrier board:** SOM-DB5830 A101-2
- Test Condition:**
 - Test temperature: room temperature
 - Test voltage: rated voltage DC +8.5V, +12.0V, +20.0V
 - Test loading:
 - Idle mode: DUT power management off and no running any program.
 - Maximum load mode: Running programs.
- OS:** Windows 10 Enterprise

1.3.17 Performance

For reference performance or benchmark data that compares with other modules, please refer to "Advantech COM Performance & Power Consumption Table".

1.3.18 Selection Guide w/ P/N

Part No.	SoC	Base/1T Boost Freq.	Core/ Thread	LLC	Default TDP	TDP Range	Thermal Solution	Operating Temperature
SOM-5871VC-H3A1	V1807B	3.35GHz/3.8GHz	4/8	2M	45W	35-54W	Active	0 ~ 60 °C
SOM-5871VC-H2A1	V1756B	3.25GHz/3.6GHz	4/8	2M	45W	35-54W	Active	0 ~ 60 °C
SOM-5871VC-U0A1	V1605B	2.0GHz/3/6GHz	4/8	2M	15W	35-54W	Active	0 ~ 60 °C
SOM-5871VC-U3A1	V1202B	2.3GHz/3/2GHz	2/4	1M	15W	35-54W	Active	0 ~ 60 °C

Note! *Passive = fanless; Active = with fan*



1.3.19 Packing list

Part No.	Description	Quantity
-	SOM-5871 CPU module	1
1960088919N001	Heatspreader	1

1.3.20 Development Board

Part No.	Description
SOM-DB5830-00A1	COMe R3.0 Devel. Board Type6 Rev.A1

1.3.21 Pin Description

Advantech provides useful checklists for schematic design and layout routing. The schematic checklist specifies details about each pin's electrical properties and how to connect for different usage. The layout checklist specifies the layout constraints and recommendations for trace length, impedance, and other necessary information during design.

Please contact your nearest Advantech branch office or call for design documents and further advances support.

Chapter 2

Mechanical Information

This chapter gives mechanical information on the SOM-5871 CPU Computer on Module

Sections include:

- Board Information
- Mechanical Drawing
- Assembly Drawing

2.1 Board Information

The figures below indicate the main chips on SOM-5871 Computer-on-Module. Please be aware on these positions while designing your customer's own carrier board to avoid mechanical and thermal problems.

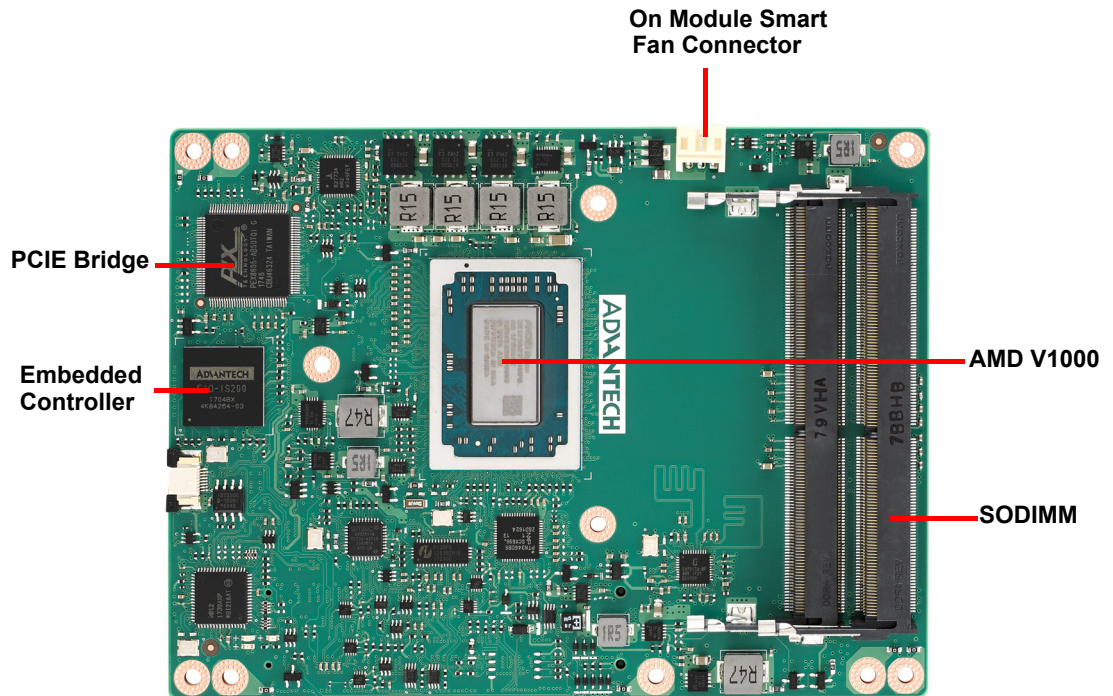

Figure 2.1 Board chips identification – Front

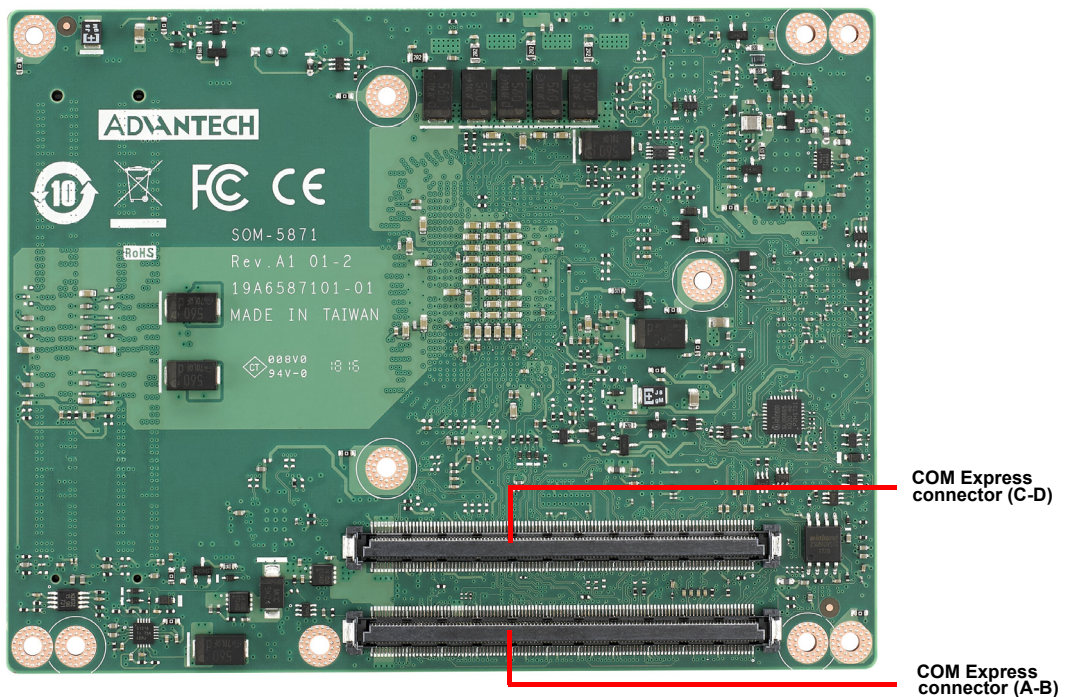
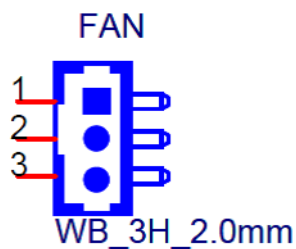

Figure 2.2 Board chips identification – Rear

2.1.1 Connector List

Table 2.1: FAN1 Fan

FAN1	Fan
Description	Wafer 2.0mm 3P 90D (M) DIP 2001-WR-03-LF W/Lock
Pin	Pin name
1	Fan Tacho-Input
2	Fan out
3	GND



2.2 Mechanical Drawing

For more detail about 2D/3D models, please find on Advantech COM support service website <http://com.advantech.com>.

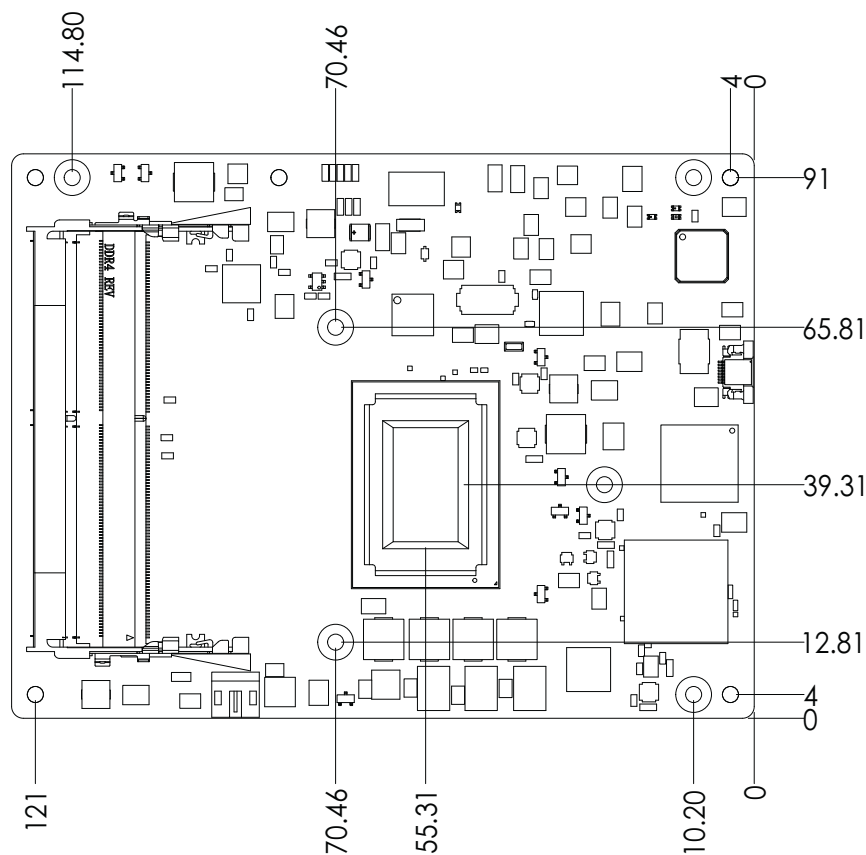

Figure 2.3 Board Mechanical Drawing – Front

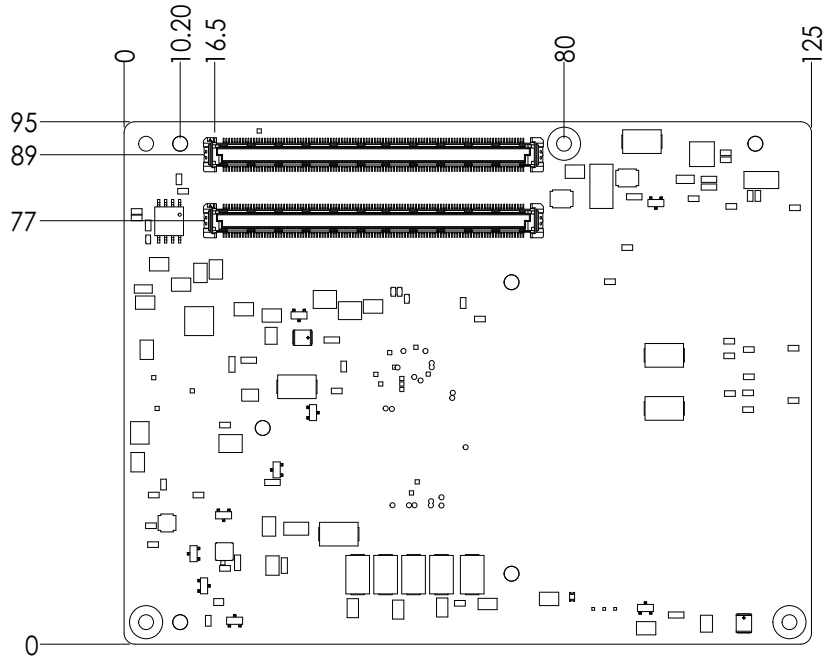

Figure 2.4 Board Mechanical Drawing – Rear

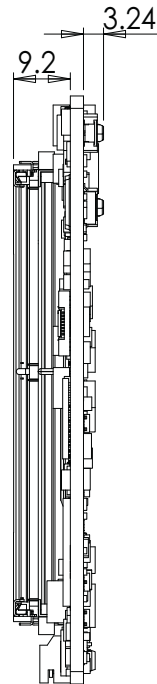

Figure 2.5 Board Mechanical Drawing – Side

2.3 Assembly Drawing

These figures demonstrate the assembly order from the thermal module, COM module to carrier board.

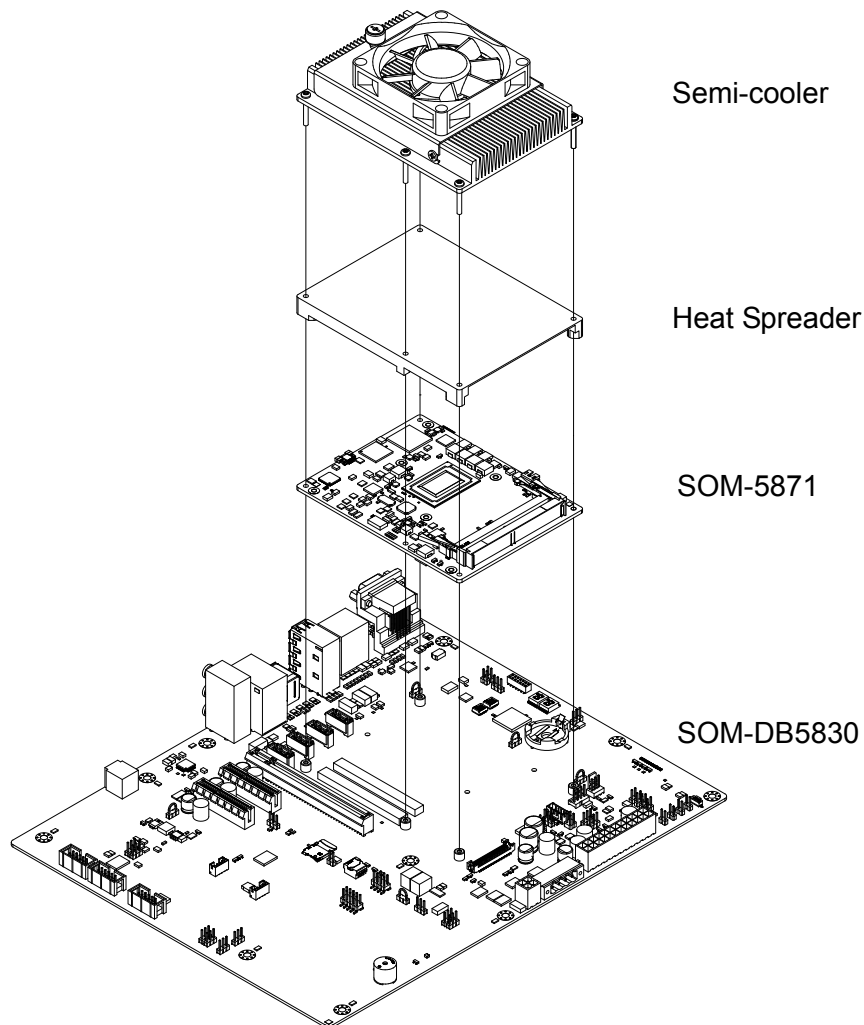

Figure 2.6 Assembly Drawing

There are 5 reserved screw holes for SOM-5871 to be pre-assembled with the heat spreader.

Chapter 3

AMI BIOS

This chapter gives BIOS setup information for the SOM-5871 CPU Computer-on Module

Sections include:

- Introduction
- Entering Setup
- Hot/Operation Key
- Exit BIOS Setup Utility

3.1 Starting

SOM-5871 BIOS is stored in a flash ROM which is inserted into a BIOS socket on the board. With the BIOS Setup program, users can modify BIOS settings and control various system features. This chapter describes the basic navigation of the SOM-5871 BIOS setup screens.

Advantech will have revisions for product optimization so customers can re-flash the latest BIOS through the AFU utility. Please contact Advantech sales or FAE for more details.

Entering the BIOS

To enter the BIOS setup screens, follow the steps below:

1. Power on the motherboard.
2. Press the Delete or Esc key on your keyboard when you see the following text prompt: Press Delete or Esc to enter setup.
3. After you press the Delete key, the main BIOS setup menu displays. You can access the other BIOS function settings.



The BIOS setup screen has three main frames. The left frame displays all information and configurable items. Grayed-out text is information only. Blue items are options that can be configured. White one is the current focus item to be selected.

The right-upper frame is an area reserved for a text message. When an option is selected from the left frame, a help text message will show at this area.

The following table shows the hot keys operation guide.

Hot Key	Description
→ Right ← Left	The Left and Right < > keys allow you to select a BIOS setup page. For example: Main page, Advanced page, Chipset page, and so on.
↑ Up ↓ Down	The Up and Down < > keys allow you to select a BIOS setup item or sub-screen.
+ - Plus/Minus	The Plus and Minus keys allow you to change the field value of a particular setup item. For example: Date and Time.
F1	The <F1> key allows you to display the General Help screen. Press the <F1> key to open the General Help screen.
F2	Load Previous Values. Ignore modified configures.
F3	Load Optimized Defaults.
F4	Save configuration and exit.
ESC	The <Esc> key allows you to go back to upper menu item. At root page, <Esc> key is used for Quit without saving.
Enter	Entering submenu or display option items.

SOM-5871 BIOS has a built-in Setup program that allows users to modify the basic system configuration. This information is stored in flash ROM so it retains the Setup information when the power is turned off.

3.1.1 Main Setup

When users first enter the BIOS Setup Utility, they will enter the Main setup screen.

You can always return to the Main setup screen by selecting the Main tab. The Main BIOS Setup screen is shown below.



The Main page shows BIOS Information

Feature	Options	Description
BIOS Information	No Option	Subtitle
BIOS Vender	No Option	Displays the BIOS vendor, where we suppliers license from.
Core Version	No Option	Displays the BIOS vendor's kernel core version.
Compliancy	No Option	Displays this BIOS supporting industry standards compliance.
Project Version	No Option	Displays the project version of Advantech projects.
Build Date and Time	No Option	Displays this BIOS build date and time.
Access Level	No Option	Please refer to session "3.1.4 Security".
Total Memory	No Option	Displays the total memory size of the system.
Memory Frequency	No Option	Displays the memory frequency.
System Date	mm/dd/yyyy	Set the system date. Use Tab to switch between Date elements. Use + / - or numbers to change the value.
System Time	hh:mm:ss	Set the system time. Use Tab to switch between Date elements. Use + / - or numbers to change the value.

3.1.2 Advanced BIOS Features Setup

Select the Advanced tab from the SOM-5871 setup screen to enter the Advanced BIOS Setup screen. Users can select any item in the left frame of the screen, such as CPU Configuration, to go to the sub menu for that item. Users can display an Advanced BIOS Setup option by highlighting it using the <Arrow> keys. All Advanced BIOS Setup options are described in this section. The Advanced BIOS Setup screens are shown below. The sub menus are described on the following pages.

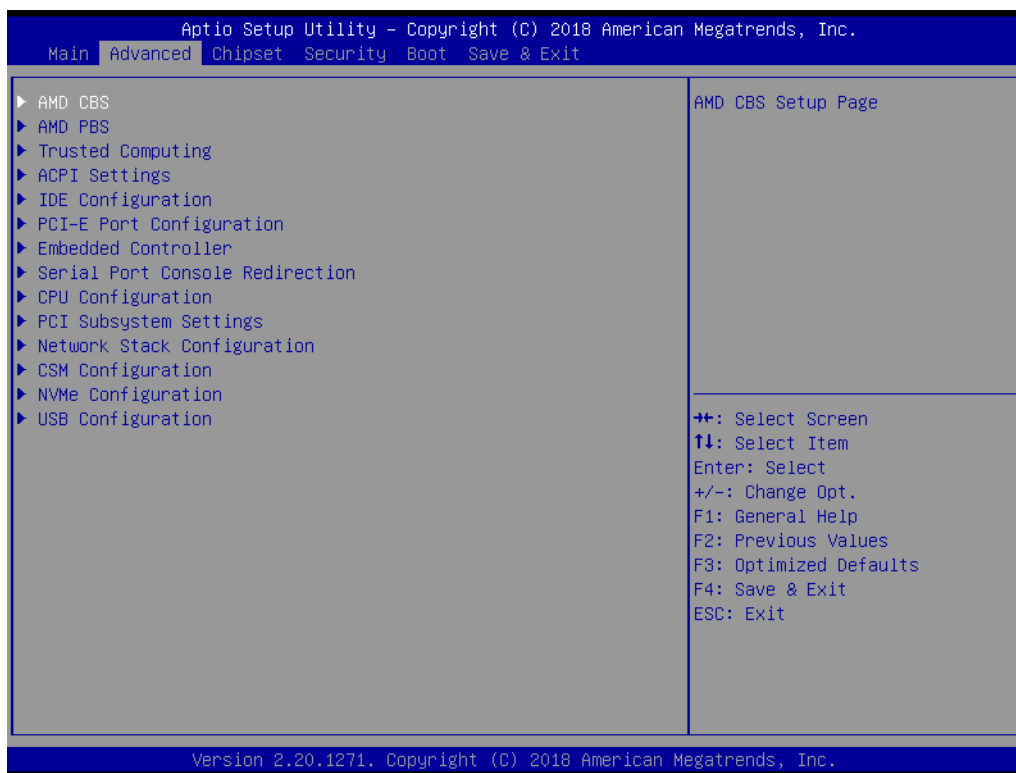

Feature	Options	Description
AMD CBS	<Sub Menu>	AMD CBS Setup Page
AMD PBS	<Sub Menu>	AMD PBS Setup Page
Trusted Computing	<Sub Menu>	Trusted Computing Settings
ACPI Settings	<Sub Menu>	System ACPI Parameters
IDE Configuration	<Sub Menu>	IDE Devices Configuration
PCI-E Port Configuration	<Sub Menu>	PCI-E Port Parameters
Embedded Controller	<Sub Menu>	Embedded Controller Parameters
Serial Port Console Redirection	<Sub Menu>	Serial Port Console Redirection
CPU Configuration	<Sub Menu>	CPU Configuration Parameters
PCI Subsystem Settings	<Sub Menu>	PCI Subsystem Settings
Network Stack Configuration	<Sub Menu>	Network Stack Settings
CSM Configuration	<Sub Menu>	CSM Configuration: Enable/Disable, option ROM execution settings, etc.
NVMe Configuration	<Sub Menu>	NVMe Device Options Settings
USB Configuration	<Sub Menu>	USB Configuration Parameters

3.1.2.1 AMD CBS



Feature	Options	Description
Zen Common Options	<Sub Menu>	Zen Common Options
NBIO Common Options	<Sub Menu>	NBIO Common Options
FCH Common Options	<Sub Menu>	FCH Common Options

3.1.2.2 Zen Common Options

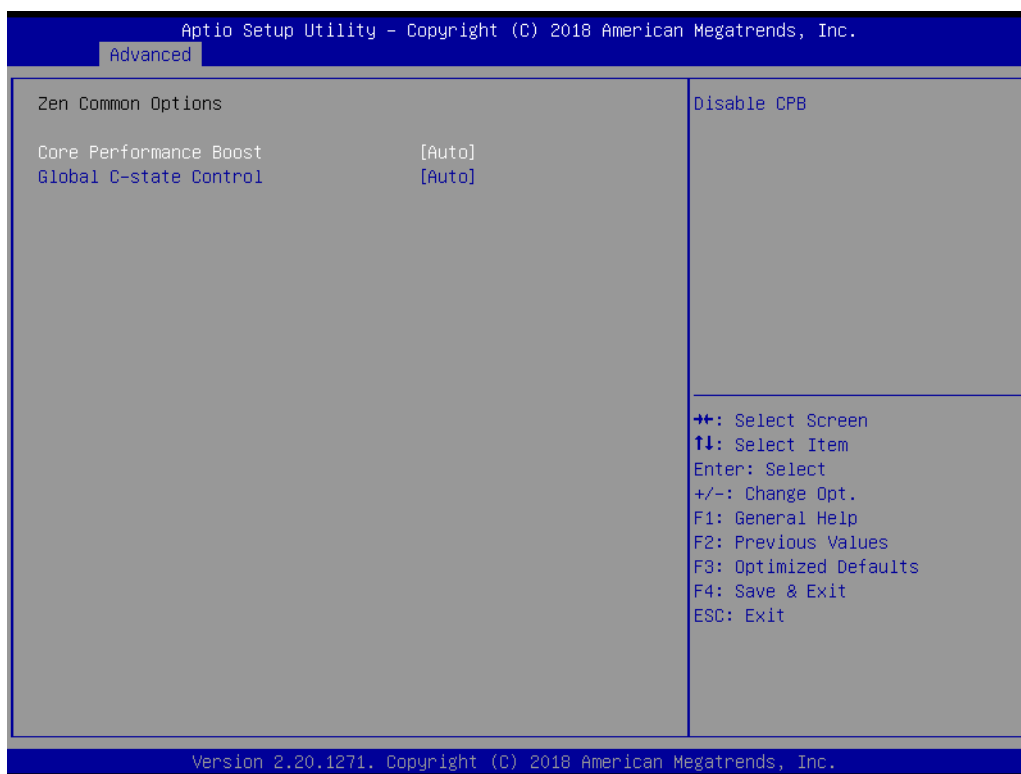

Feature	Options	Description
Core Performance Boost	Disabled Auto	Disable CPB
Global C-state Control	Disabled Enabled Auto	Controls IO based C-state generation and DF C-states

3.1.2.3 NBIO Common Options

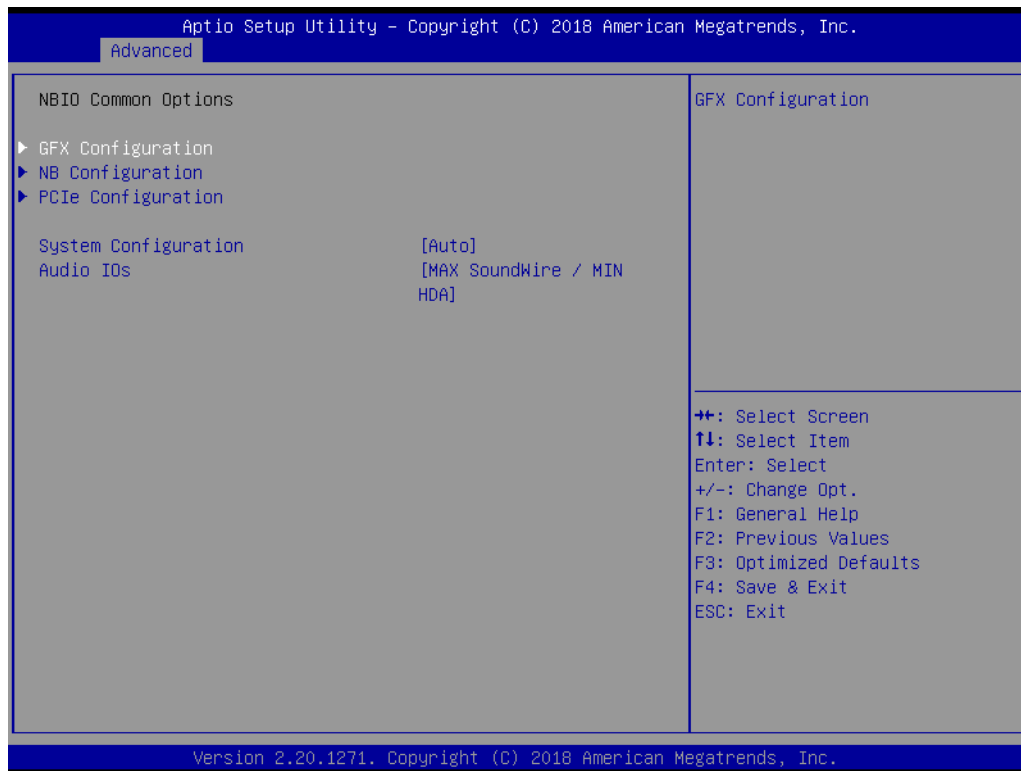

Feature	Options	Description
GFX Configuration	<Sub Menu>	GFX Configuration
NB Configuration	<Sub Menu>	NB Configuration
PCIe Configuration	<Sub Menu>	PCIe Configuration
System Configuration	35W POR Configuration 45W POR Configuration 54W POR Configuration Auto	Warning: Selecting some system configurations may cause the system to hang, as some setting may not be supported by your OPN.
Audio I/O	Auto MAX HAD/MIN SoundWire MAX mHDA/MIN SoundWire Max SoundWire/MIN HAD I2S/TDM Soundwire DISABLE AUDIO IOs	Audio I/O Control

■ GFX Configuration



Feature	Options	Description
Integrated Graphics Controller	Disabled Forces Auto	Enable Integrated Graphics controller
NB Azalia	Disabled Enabled Auto	Enable Integrate HD Audio controller

■ NB Configuration

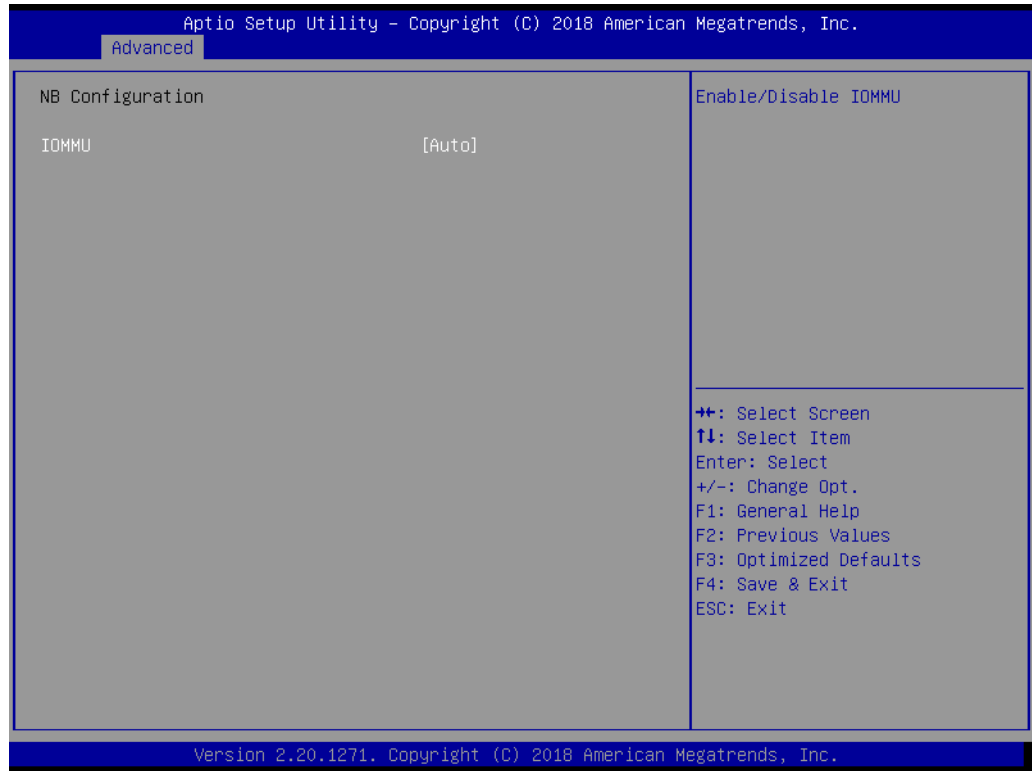

Feature	Options	Description
IOMMU	Disabled Enabled Auto	Enable/Disable IOMMU

3.1.2.4 PCIe Configuration



Feature	Options	Description
PSPP Policy	Disabled Performance Balanced-High Balanced-Low Power Saving Auto	No help string

■ FCH Common Options

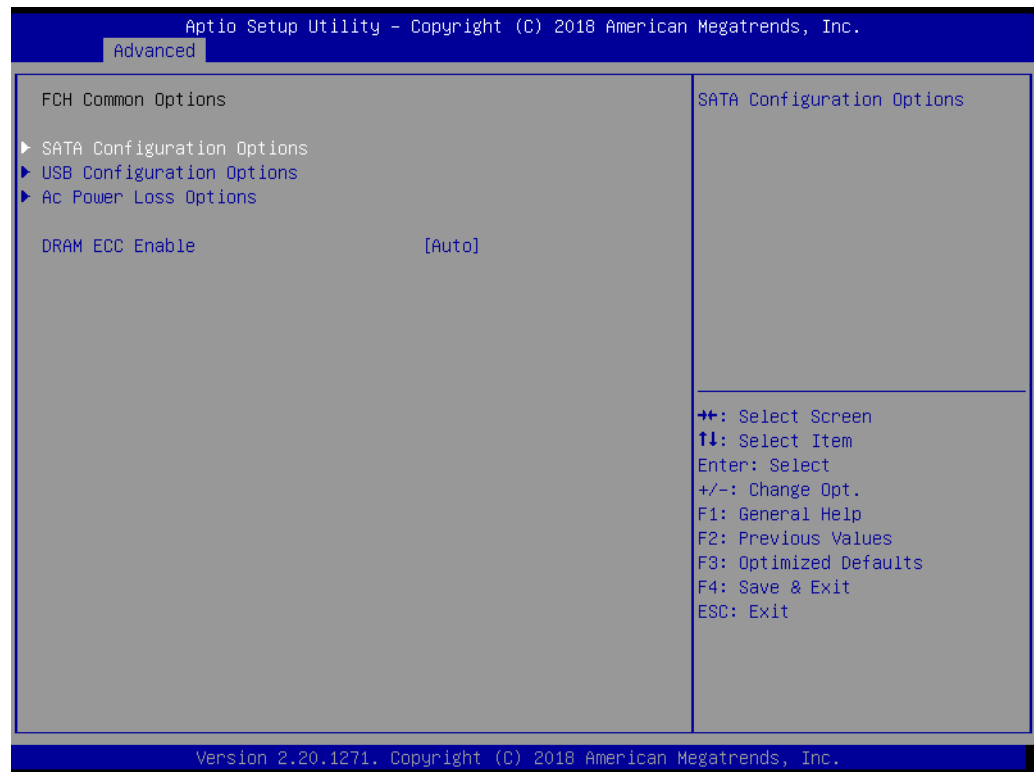

Feature	Options	Description
SATA Configuration Options	<Sub Menu>	SATA Configuration Options
USB Configuration Options	<Sub Menu>	USB Configuration Options
AC Power Loss Options	<Sub Menu>	AC Power Loss Options
DRAM ECC Enable	Disabled Enabled Auto	

■ SATA Configuration Options



Feature	Options	Description
SATA Controller	Disabled Enabled Auto	Disable or enable on chip SSATA controller
SATA RAS Support	Disabled Enabled Auto	Disable or enable SATA RAS support
SATA Disabled AHCI Prefetch Function	Disabled Enabled Auto	Disable or enable SATA AHCI prefetch function
SATA Port 0 MODE	GEN1 GEN2 Auto	Indicates the highest allowable speed of the SATA port 0
SATA Port 1 MODE	GEN1 GEN2 Auto	Indicates the highest allowable speed of the SATA port 1

■ USB Configuration Options

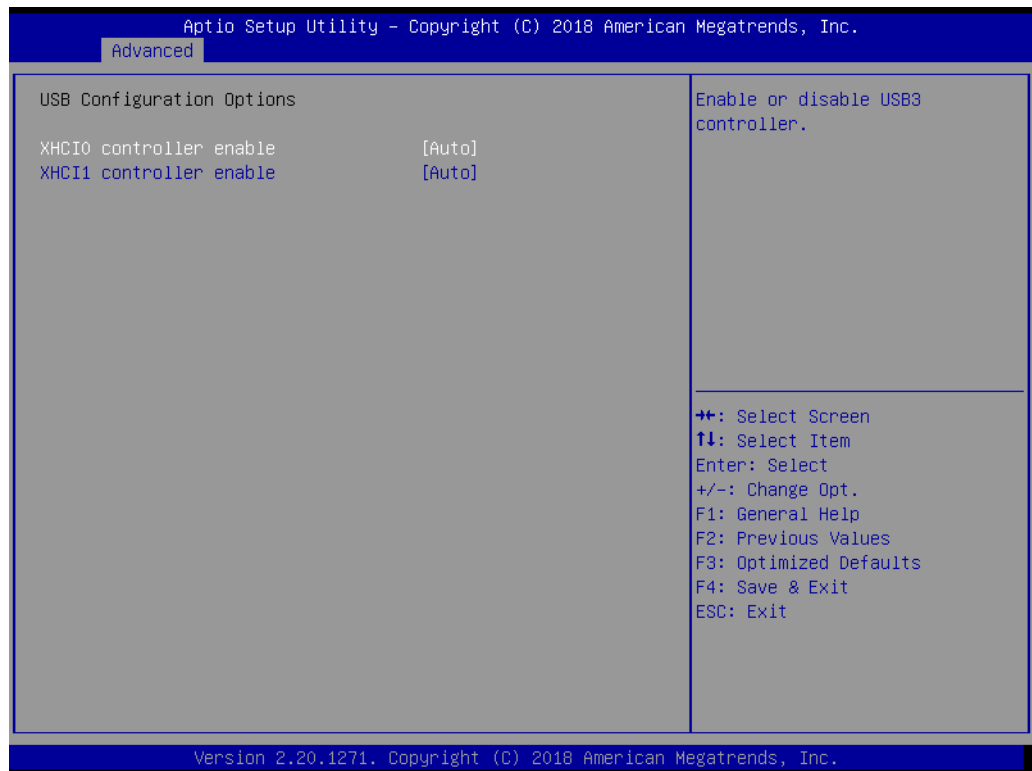

Feature	Options	Description
XHCI0 controller enable	Enabled Disabled Auto	Enable or disable USB3 controller
XHCI1 controller enable	Enabled Disabled Auto	Enable or disable USB3 controller

■ AC Power Loss Options

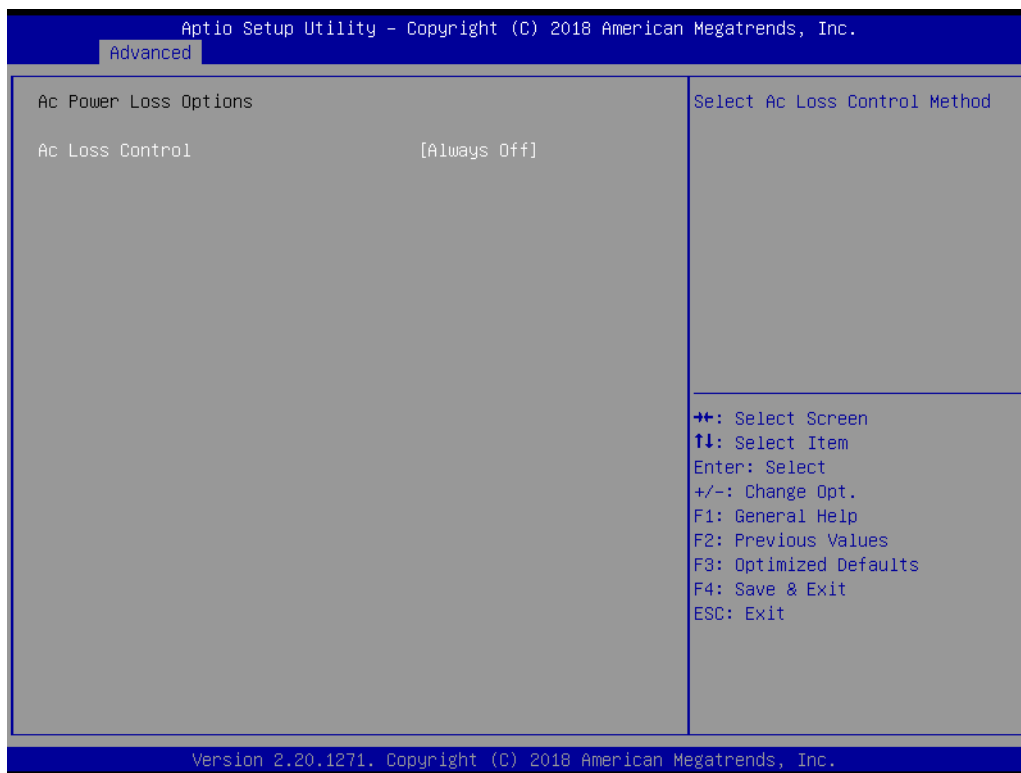

Feature	Options	Description
AC Loss Control	Always Off Always On Reserved Previous	Select AC loss control method

■ **AMD PBS**

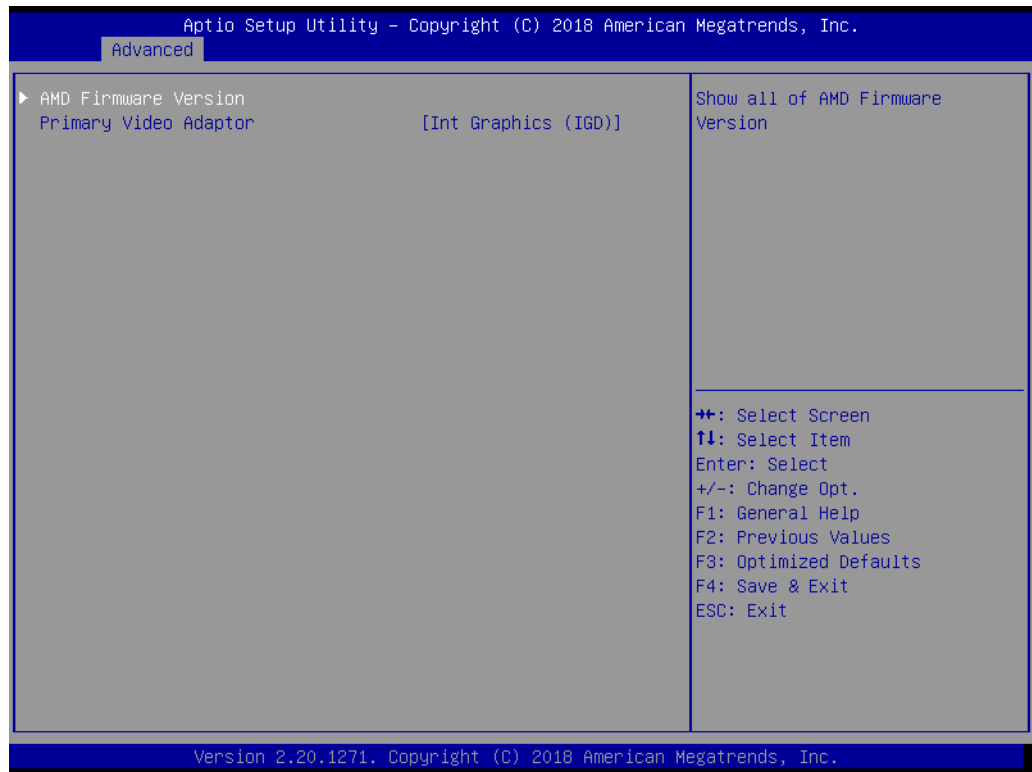

Feature	Options	Description
AMD Firmware Version	<Sub Menu>	Shows all of AMD Firmware Version
Primary Video Adaptor	Int Graphics (IGD) Ext Graphics (PEG)	Select Internal/External Graphics

■ AMD Firmware Version

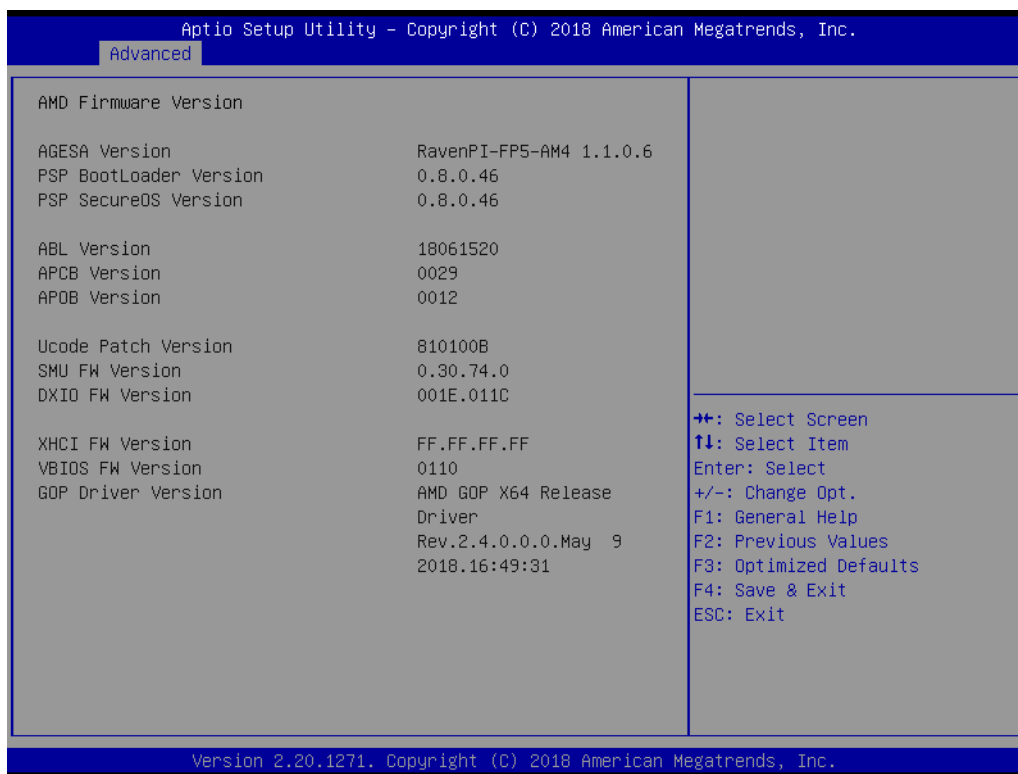

Feature	Options	Description
AGESA Version	No option	Shows the current status
PSP BootLoader Version	No option	Shows the current status
PSP SecureOS Version	No option	Shows the current status
ABL Version	No option	Shows the current status
APCB Version	No option	Shows the current status
APOB Version	No option	Shows the current status
Ucode Patch Version	No option	Shows the current status
SMU FW Version	No option	Shows the current status
DXIO FW Version	No option	Shows the current status
XHCI FW Version	No option	Shows the current status
VBIOS FW Version	No option	Shows the current status
GOP Driver Version	No option	Shows the current status

■ Trusted Computing



Feature	Options	Description
Security Device Support	Disable Enable	Enables or Disables BIOS support for security device. O.S. will not show Security Device. TCG EFI protocol and INT1A interface will not be available.
Pending operation	None TPM Clear	Schedule an Operation for the Security Device. NOTE: Your Computer will reboot during restart in order to change State of Security Device.
Device Select	TPM 1.2 TPM 2.0 Auto	TPM 1.2 will restrict support to TPM 1.2 devices, TPM 2.0 will restrict support to TPM 2.0 devices, Auto will support both with the default set to TPM 2.0 devices if not found, TPM 1.2 devices will be enumerated

■ ACPI Settings

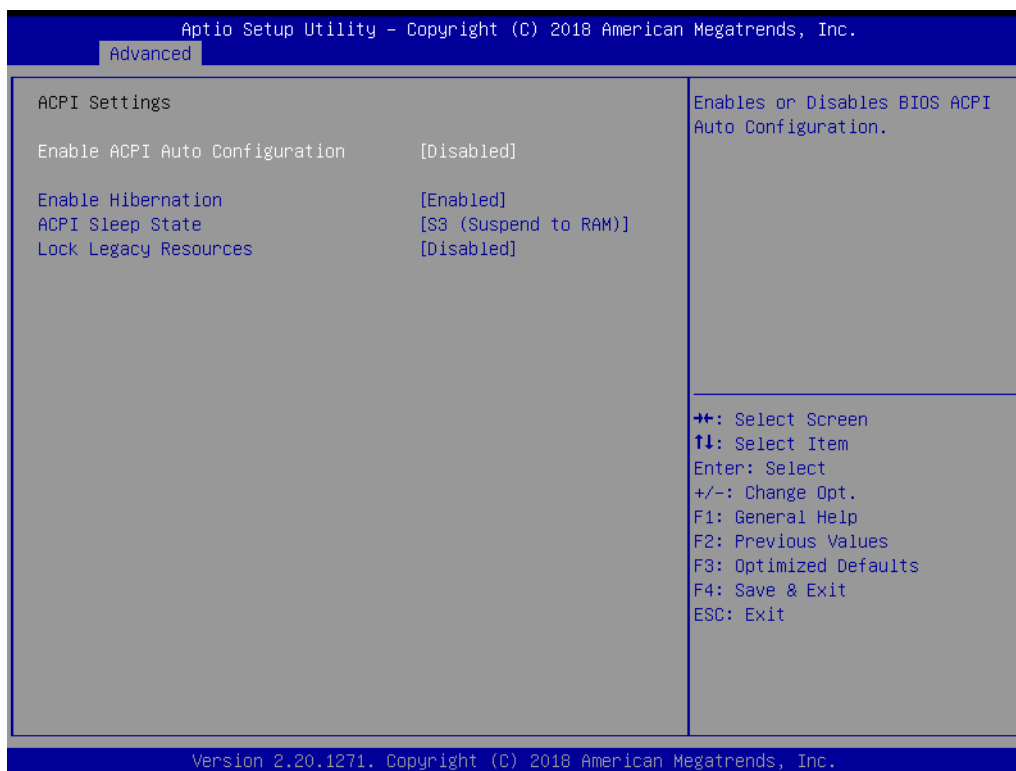

Feature	Options	Description
Enable ACPI Auto Configuration	Disabled Enabled	Enables or Disables BIOS ACPI Auto Configuration.
Enable Hibernation	Disabled Enabled	Enables or Disables System ability to Hibernate (OS/S4 Sleep State). This option may not be effective with some operating systems.
ACPI Sleep State	Suspend Disable S3(Suspend to RAM)	Select the highest ACPI sleep state the system will enter when the SUSPEND button is pressed.
Lock Legacy Resources	Disabled Enabled	Enables or Disables Lock of Legacy Resources

3.1.2.5 IDE Configuration

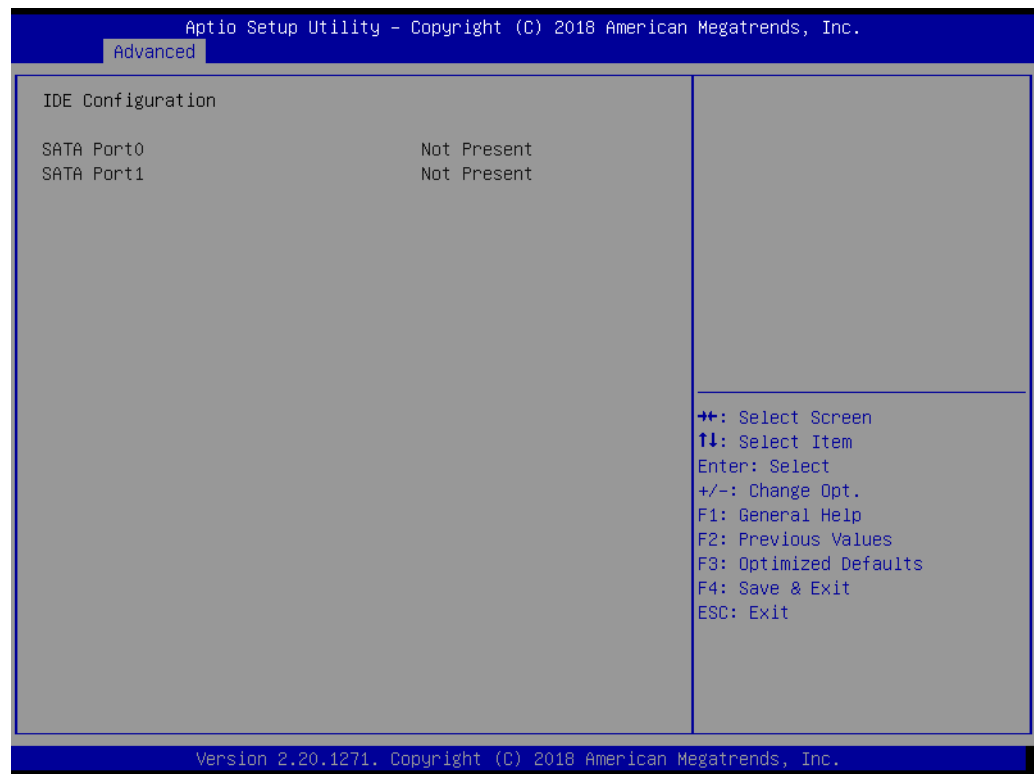

Feature	Options	Description
SATA Port0	No option	Shows the current status
SATA Port1	No Option	Shows the current status

3.1.2.6 PCI-E Port Configuration



Feature	Options	Description
PCI-E Port	<Sub Menu>	PCI-E Port Parameters

3.1.2.7 PCI-E Port

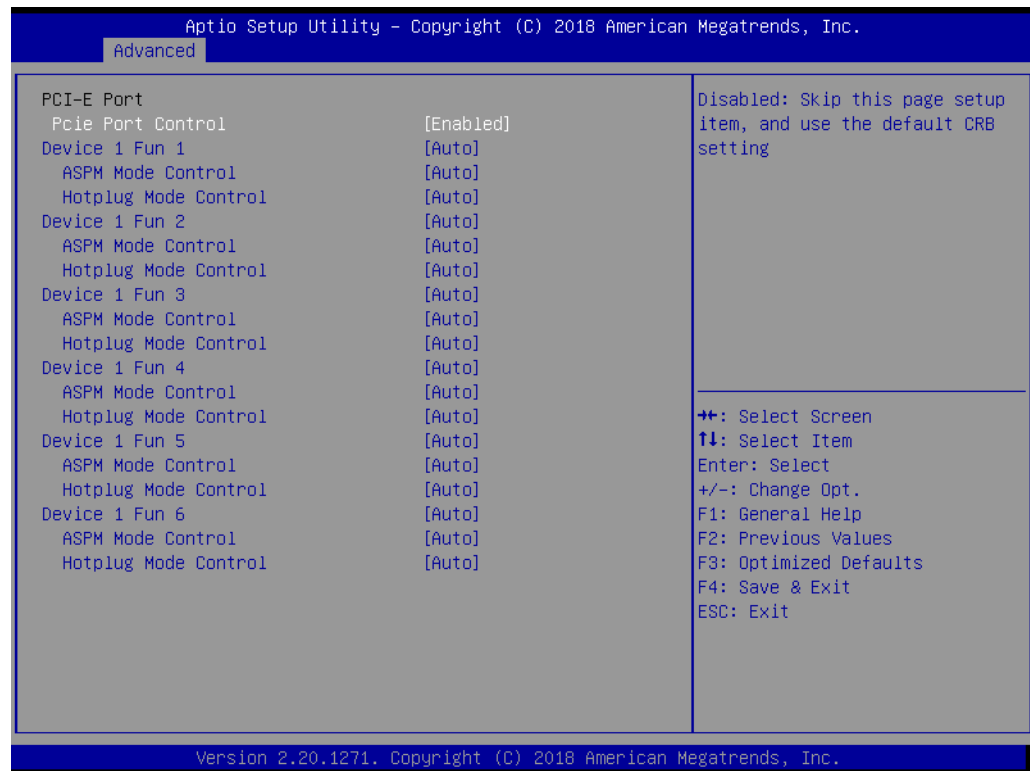

Feature	Options	Description
PCie Port Control	Disabled Enabled	Disabled: Skip this page setup item, and use the default CRB setting
Device 1 Fun 1	Disabled Enabled Auto	Enable/Disable/Auto, Auto uses board default setting
ASPM Mode Control	Disabled L0s Entry L1 Entry L0s And L1 Entry Auto	NB Root Port ASPM Mode Control
Hotplug Mode Control	Disabled Hotplug Basic Hotplug Server Hotplug Enhanced Hotplug Inboard Auto	NB Root Port Hotplug Mode Control
Device 1 Fun 2	Disabled Enabled Auto	Enable/Disable/Auto, Auto uses board default setting
ASPM Mode Control	Disabled L0s Entry L1 Entry L0s And L1 Entry Auto	NB Root Port ASPM Mode Control

Hotplug Mode Control	Disabled Hotplug Basic Hotplug Server Hotplug Enhanced Hotplug Inboard Auto	NB Root Port Hotplug Mode Control
Device 1 Fun 3	Disabled Enabled Auto	Enable/Disable/Auto, Auto uses board default setting
ASPM Mode Control	Disabled L0s Entry L1 Entry L0s And L1 Entry Auto	NB Root Port ASPM Mode Control
Hotplug Mode Control	Disabled Hotplug Basic Hotplug Server Hotplug Enhanced Hotplug Inboard Auto	NB Root Port Hotplug Mode Control
Device 1 Fun 4	Disabled Enabled Auto	Enable/Disable/Auto, Auto uses board default setting
ASPM Mode Control	Disabled L0s Entry L1 Entry L0s And L1 Entry Auto	NB Root Port ASPM Mode Control
Hotplug Mode Control	Disabled Hotplug Basic Hotplug Server Hotplug Enhanced Hotplug Inboard Auto	NB Root Port Hotplug Mode Control
Device 1 Fun 5	Disabled Enabled Auto	Enable/Disable/Auto, Auto uses board default setting
ASPM Mode Control	Disabled L0s Entry L1 Entry L0s And L1 Entry Auto	NB Root Port ASPM Mode Control
Hotplug Mode Control	Disabled Hotplug Basic Hotplug Server Hotplug Enhanced Hotplug Inboard Auto	NB Root Port Hotplug Mode Control
Device 1 Fun 6	Disabled Enabled Auto	Enable/Disable/Auto, Auto uses board default setting
ASPM Mode Control	Disabled L0s Entry L1 Entry L0s And L1 Entry Auto	NB Root Port ASPM Mode Control

Hotplug Mode Control	Disabled Hotplug Basic Hotplug Server Hotplug Enhanced Hotplug Inboard Auto	NB Root Port Hotplug Mode Control
----------------------	--	-----------------------------------

■ Embedded Controller

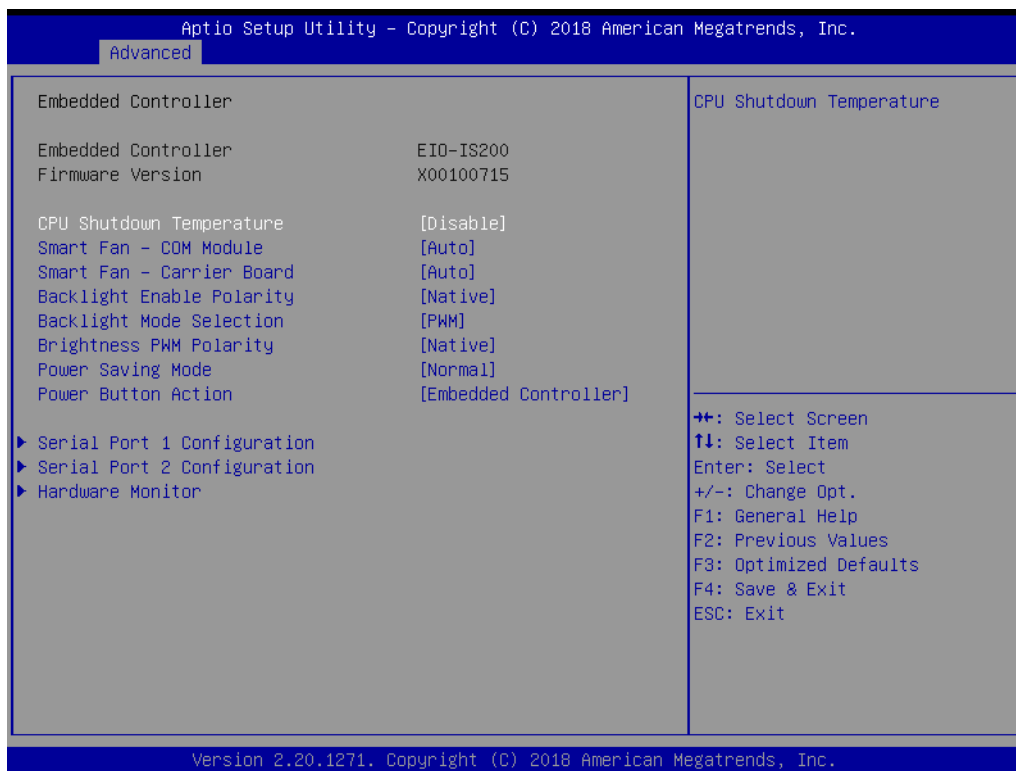

Feature	Options	Description
CPU Shutdown Temperature	Disable 70°C/158°F 75°C/167°F 80°C/176°F 85°C/185°F 90°C/194°F 95°C/203°F 100°C/212°F	CPU shutdown temperature
Smart Fan - COM Module	Stop Full Manual Auto	Controls COM module smart FAN function. Gets value from EC and only sets value when changes are saved.
Smart Fan - Carrier Board	Stop Full Manual Auto	Controls carrier board smart FAN function. Gets value from EC and only set value when changes are saved.
Backlight Enable Polarity	Native Invert	Switches backlight to enable polarity for native or invert
Backlight Mode Selection	PWM DC	Switches backlight control to PWM or DC mode.
Brightness PWM Polarity	Native Invert	Backlight controls brightness PWM polarity for native or invert
Power Saving Mode	Normal Deep Sleep	Selects power saving mode
Power Button Action	Embedded Controller Operating System	Selects power button action control by EC or OS
Serial Port 1 Configuration	<Sub Menu>	Sets parameters of serial port 1 (COMG)

Serial Port 2 Configuration	<Sub Menu>	Sets parameters of serial port 2 (COMH)
Hardware Monitor	<Sub Menu>	Monitor hardware status

Serial Port 1 Configuration

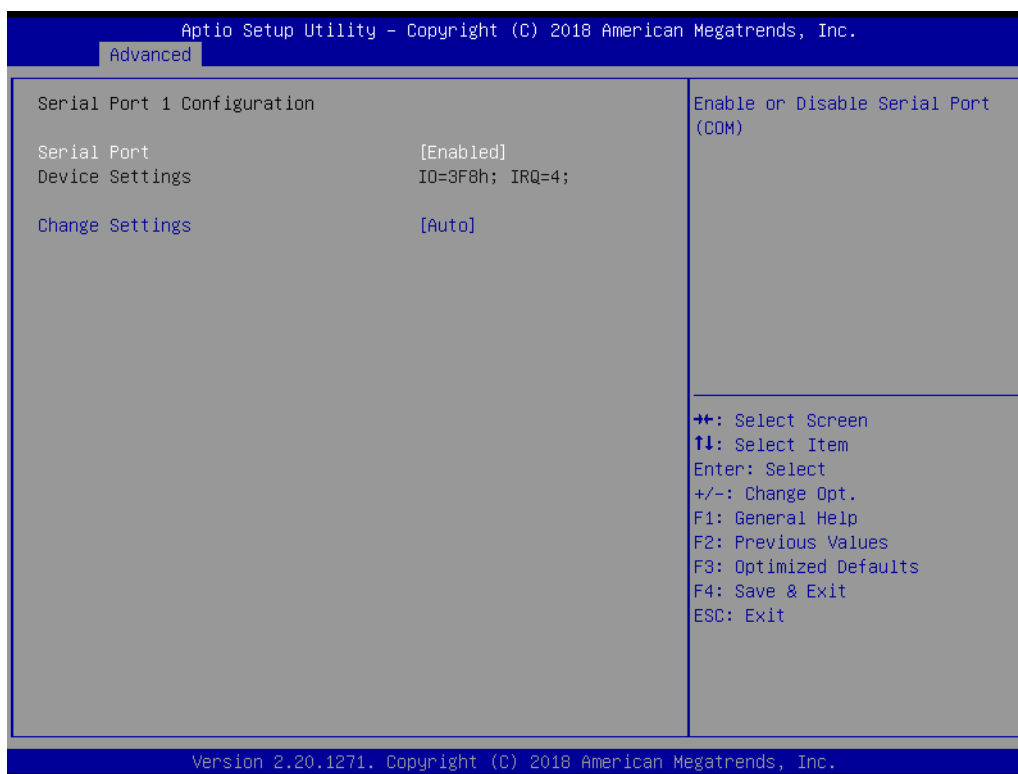

Feature	Options	Description
Serial Port	Disabled Enabled	Enable or Disable serial port (COM)
Change Setting	Auto IO=3F8h; IRQ=4 IO=2F8h; IRQ=4 IO=3E8h; IRQ=4 IO=2E8h; IRQ=4	Select an optimal setting for Super IO Device

■ Serial Port 2 Configuration

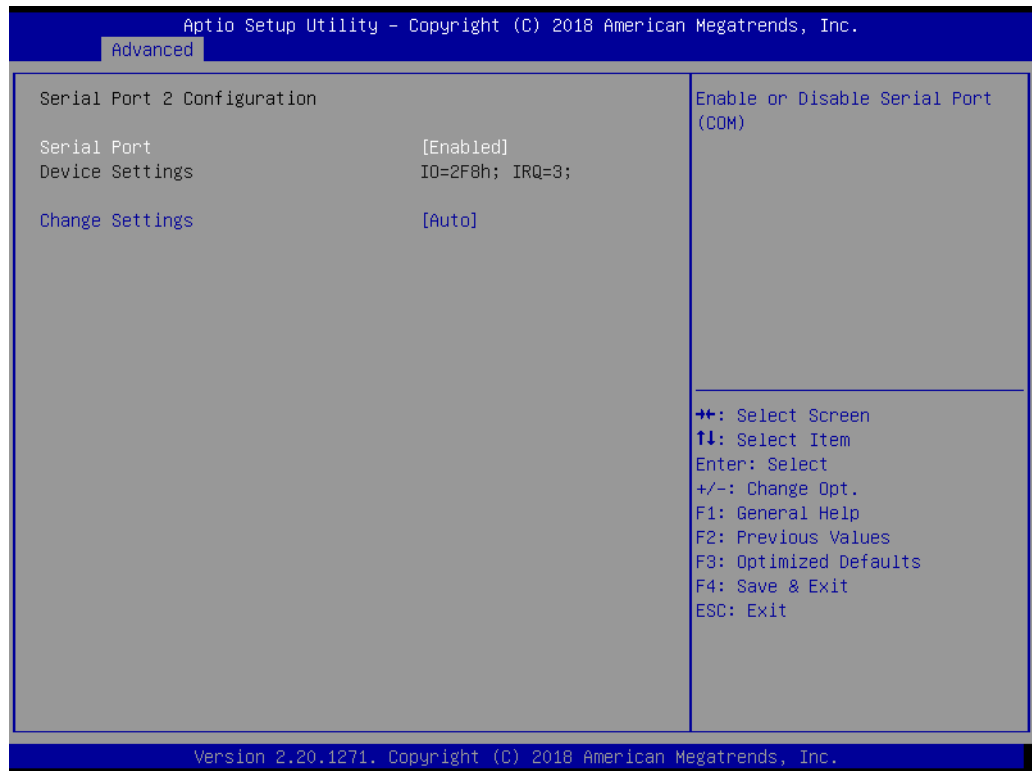

Feature	Options	Description
Serial Port	Disabled Enabled	Enable or Disable serial port (COM)
Change Settings	Auto IO=2F8h; IRQ=3 IO=3F8h; IRQ=3 IO=3E8h; IRQ=3 IO=2E8h; IRQ=3	Select an optimal settings for Super IO Device

■ Hardware Monitor

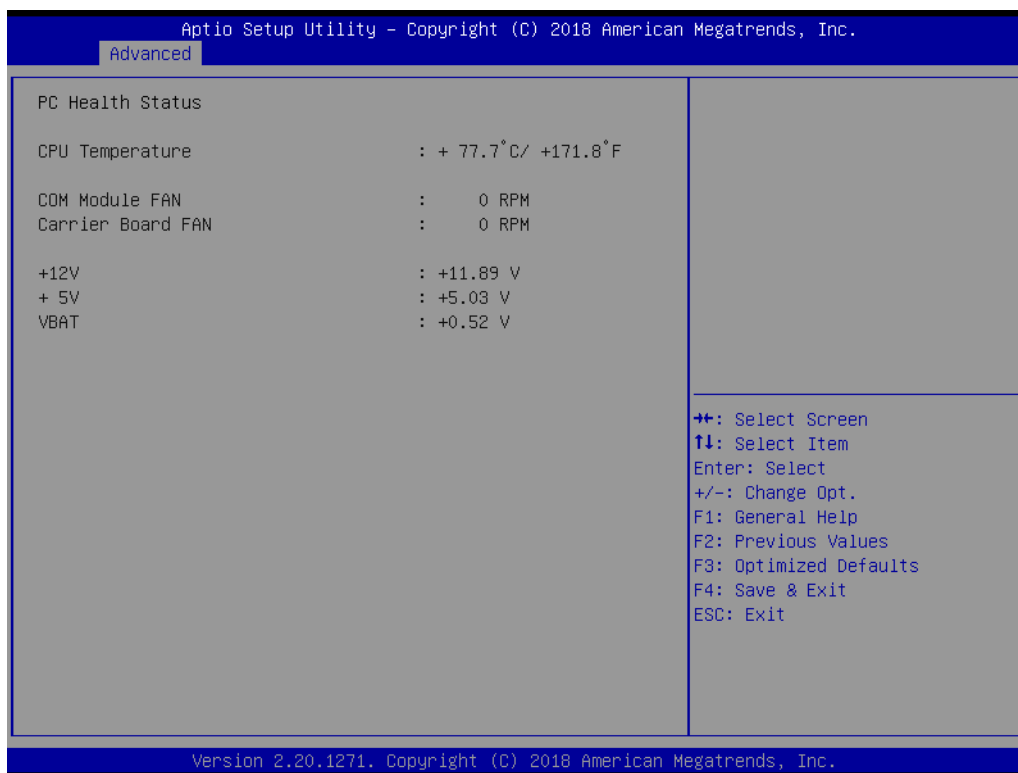

Feature	Options	Description
CPU Temperature	No option	Shows the current status
COM Module FAN	No option	Shows the current status
Carrier Board FAN	No option	Shows the current status
+12V	No option	Shows the current status
+ 5V	No option	Shows the current status
VBAT	No option	Shows the current status

3.1.2.8 Serial Port Console Redirection

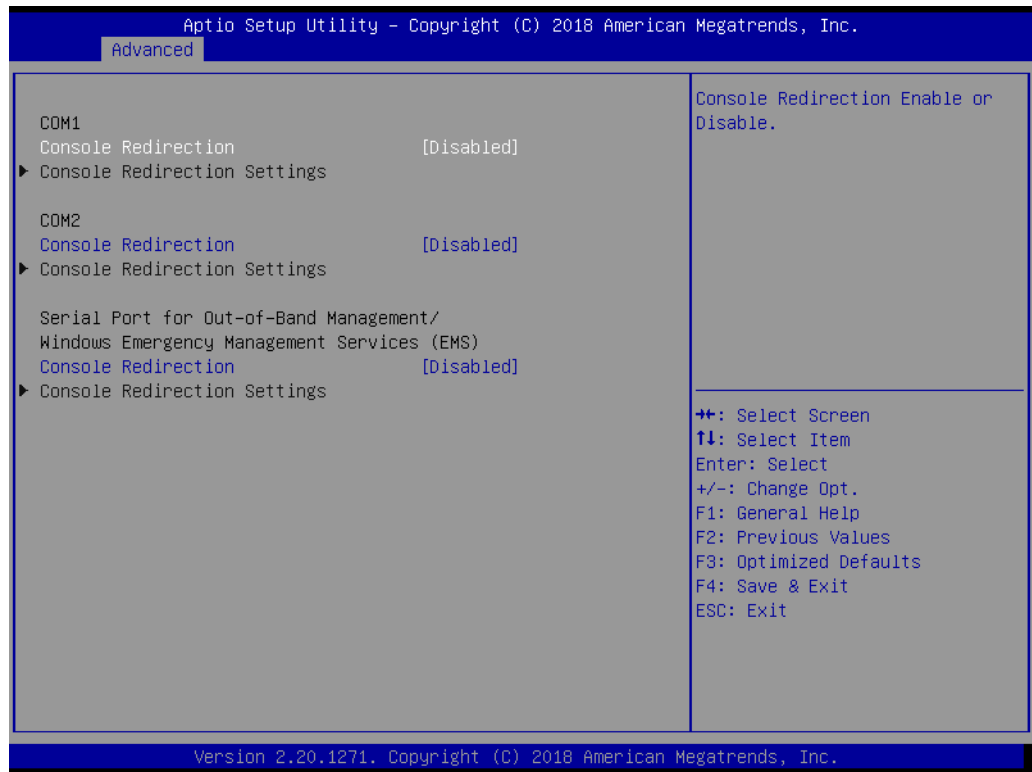

Feature	Options	Description
COM1		
Console Redirection	Disabled Enabled	Console Redirection Enable or Disable.
COM2		
Console Redirection	Disabled Enabled	Console Redirection Enable or Disable.
EMS		
Console Redirection	Disabled Enabled	Console Redirection Enable or Disable.

3.1.2.9 Console Redirection Settings (COM1)

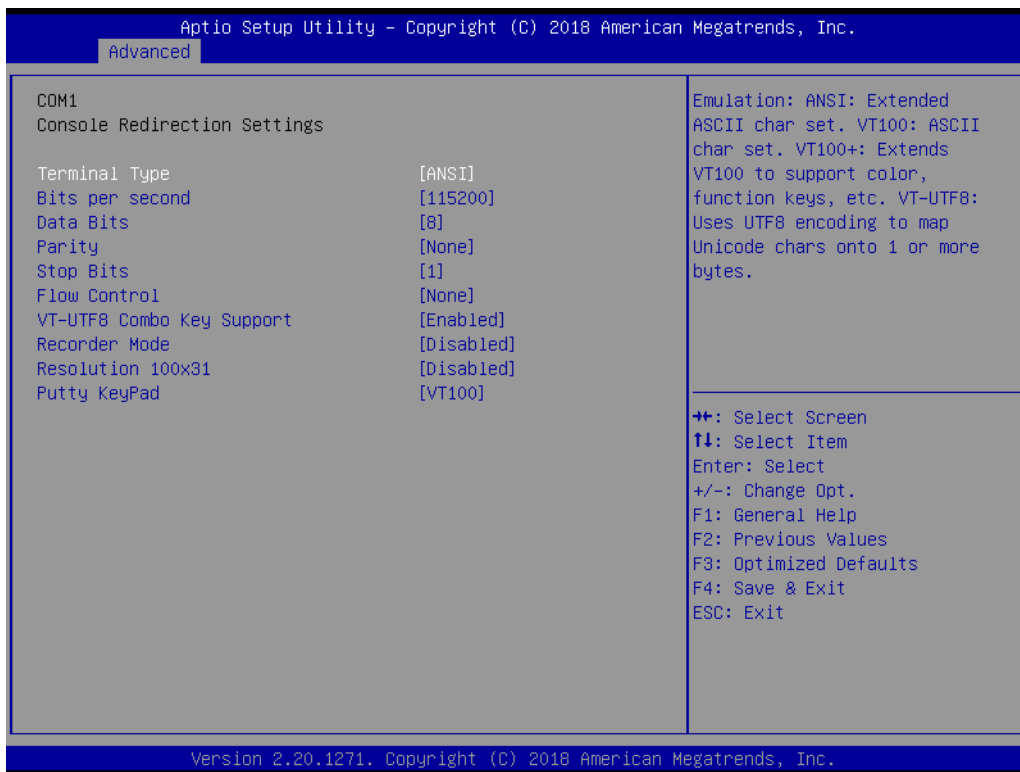

Feature	Options	Description
Terminal Type	VT100 VT100+ VT-UTF8 ANSI	Emulation: ANSI: Extended ASCII char set. VT100: ASCII char set. VT100+: Extends VT100 to support color, function keys, etc. VT-UTF8: Uses UTF8 encoding to map Unicode chars onto 1 or more bytes.
Bits per second	9600 19200 38400 57600 115200	Selects serial port transmission speed. The speed must be matched on the other side. Long or noisy lines may require lower speeds.
Data Bits	7 8	Data Bits
Parity	None Even Odd Mark Space	A parity bit can be sent with the data bits to detect some transmission errors. Even: parity bit is 0 if the num of 1's in the data bits is even. Odd: parity bit is 0 if num of 1's in the data bits is odd. Mark: parity bit is always 1. Space: Parity bit is always 0. Mark and Space Parity do not allow for error detection. They can be used as an additional data bit.
Stop Bits	1 2	Stop bits indicate the end of a serial data packet. (A start bit indicates the beginning). The standard setting is 1 stop bit. Communication with slow devices may require more than 1 stop bit.
Flow Control	None Hardware RTS/ CTS	Flow control can prevent data loss from buffer overflows. When sending data, if the receiving buffers are full, a 'stop' signal can be sent to stop the data flow. Once the buffers are empty, a 'start' signal can be sent to re-start the flow. Hardware flow control uses two wires to send start/stop signals.

VT-UTF8 Combo Key Support	Disabled Enabled	Enables VT-UTF8 combination key support for ANSI/VT100 terminals
Recorder Mode	Disabled Enabled	With this mode enabled only text will be sent. This is to capture terminal data.
Resolution 100x31	Disabled Enabled	Enables or disables extended terminal resolution
Putty KeyPad	VT100 LINUX XTERMR6 SCO ESCN VT400	Selects FunctionKey and KeyPad on Putty.

3.1.2.10 Console Redirection Settings (COM2)

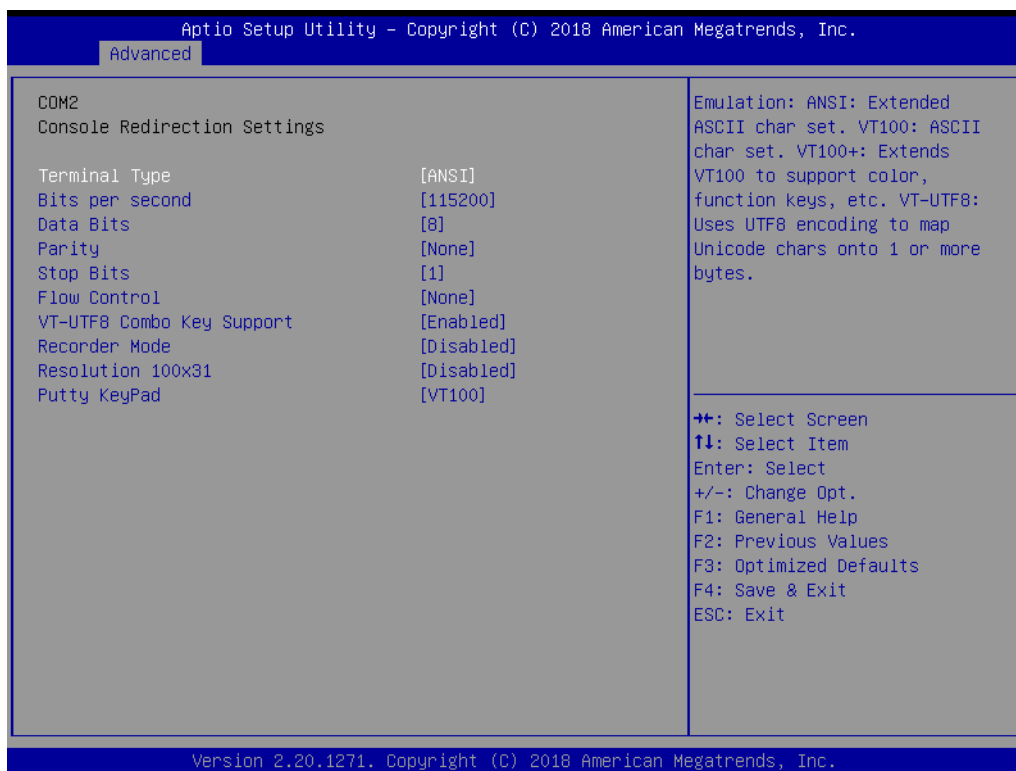

Feature	Options	Description
Terminal Type	VT100 VT100+ VT-UTF8 ANSI	Emulation: ANSI: Extended ASCII char set. VT100: ASCII char set. VT100+: Extends VT100 to support color, function keys, etc. VT-UTF8: Uses UTF8 encoding to map Unicode chars onto 1 or more bytes.
Bits per second	9600 19200 38400 57600 115200	Selects serial port transmission speed. The speed must be matched on the other side. Long or noisy lines may require lower speeds.
Data Bits	7 8	Data Bits
Parity	None Even Odd Mark Space	A parity bit can be sent with the data bits to detect some transmission errors. Even: parity bit is 0 if the num of 1's in the data bits is even. Odd: parity bit is 0 if num of 1's in the data bits is odd. Mark: parity bit is always 1. Space: Parity bit is always 0. Mark and Space Parity do not allow for error detection. They can be used as an additional data bit.
Stop Bits	1 2	Stop bits indicate the end of a serial data packet. (A start bit indicates the beginning). The standard setting is 1 stop bit. Communication with slow devices may require more than 1 stop bit.
Flow Control	None Hardware RTS/CTS	Flow control can prevent data loss from buffer overflow. When sending data, if the receiving buffers are full, a 'stop' signal can be sent to stop the data flow. Once the buffers are empty, a 'start' signal can be sent to re-start the flow. Hardware flow control uses two wires to send start/stop signals.

VT-UTF8 Combo Key Support	Disabled Enabled	Enables VT-UTF8 combination key support for ANSI/VT100 terminals
Recorder Mode	Disabled Enabled	With this mode enabled only text will be sent. This is to capture terminal data.
Resolution 100x31	Disabled Enabled	Enables or disables extended terminal resolution
Putty KeyPad	VT100 LINUX XTERMR6 SCO ESCN VT400	Select FunctionKey and KeyPad on Putty.

3.1.2.11 Console Redirection Settings

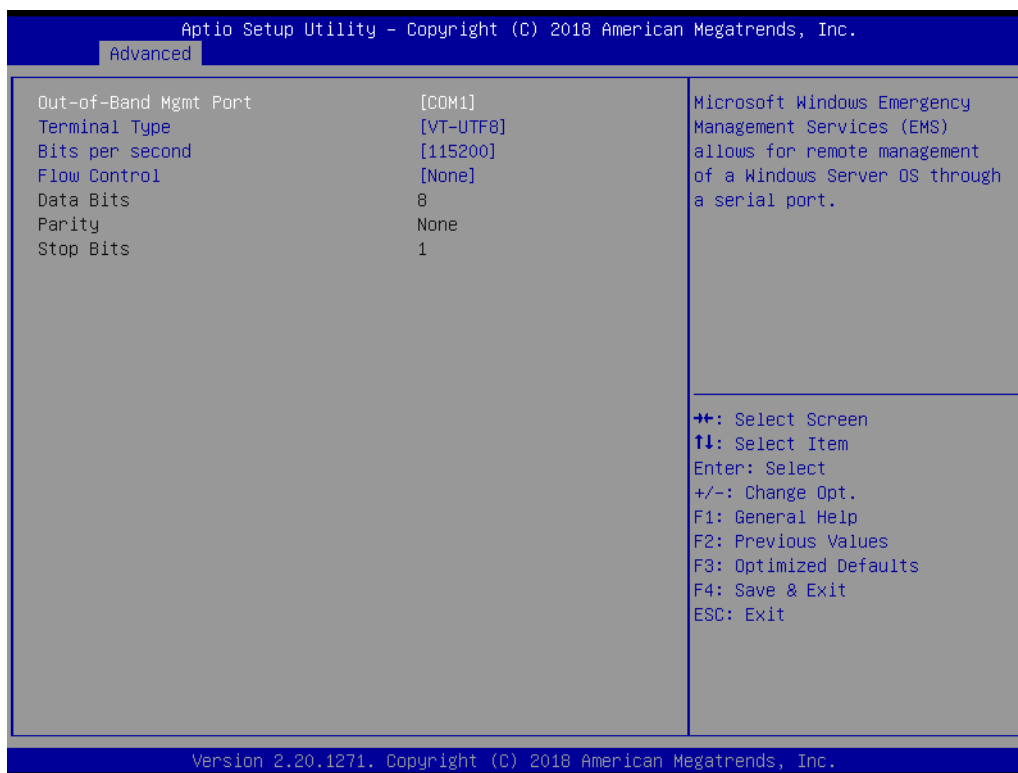

Feature	Options	Description
Out-of-Band Mgmt Port	COM1 COM2	Microsoft Windows Emergency Management Services (EMS) allows for remote management of a Windows Server OS through a serial port.
Terminal Type	VT100 VT100+ VT-UTF8 ANSI	VT-UTF8 is the preferred terminal type for out-of-band management. The next best choice is VT100+ and then VT100. See above, in Console Redirection Settings page, for more help with terminal type/emulation.
Bits per second	9600 19200 57600 115200	Selects serial port transmission speed. The speed must be matched on the other side. Long or noisy lines may require lower speeds.
Flow Control	None Hardware RTS/CTS Software Xon/ Xoff	Flow control can prevent data loss from buffer overflow. When sending data, if the receiving buffers are full, a 'stop' signal can be sent to stop the data flow. Once the buffers are empty, a 'start' signal can be sent to re-start the flow. Hardware flow control uses two wires to send start/stop signals.
Data Bits	No option	Shows the current status
Parity	No option	Shows the current status
Stop Bits	No option	Shows the current status

3.1.2.12 CPU Configuration

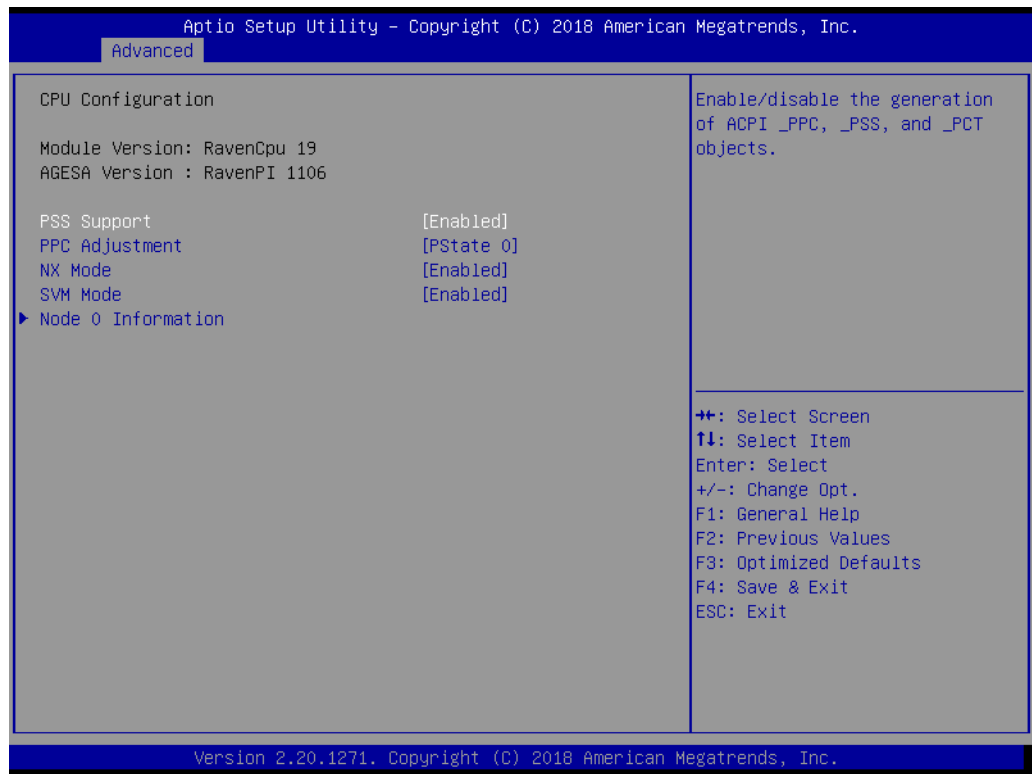

Feature	Options	Description
PSS Support	Disabled Enabled	Enable/disable the generation of ACPI _PPC, _PSS, and _PCT objects.
PPC Adjustment	PState 0 PState 1 PState 2	Provide to adjust _PPC object.
NX Mode	Disabled Enabled	Enable/disable No-execute page protection Function
SVM Mode	Disabled Enabled	Enable/disable CPU Virtualization
Node 0 Information	<Sub Menu>	View memory information related to Node 0

3.1.2.13 Node 0 Information

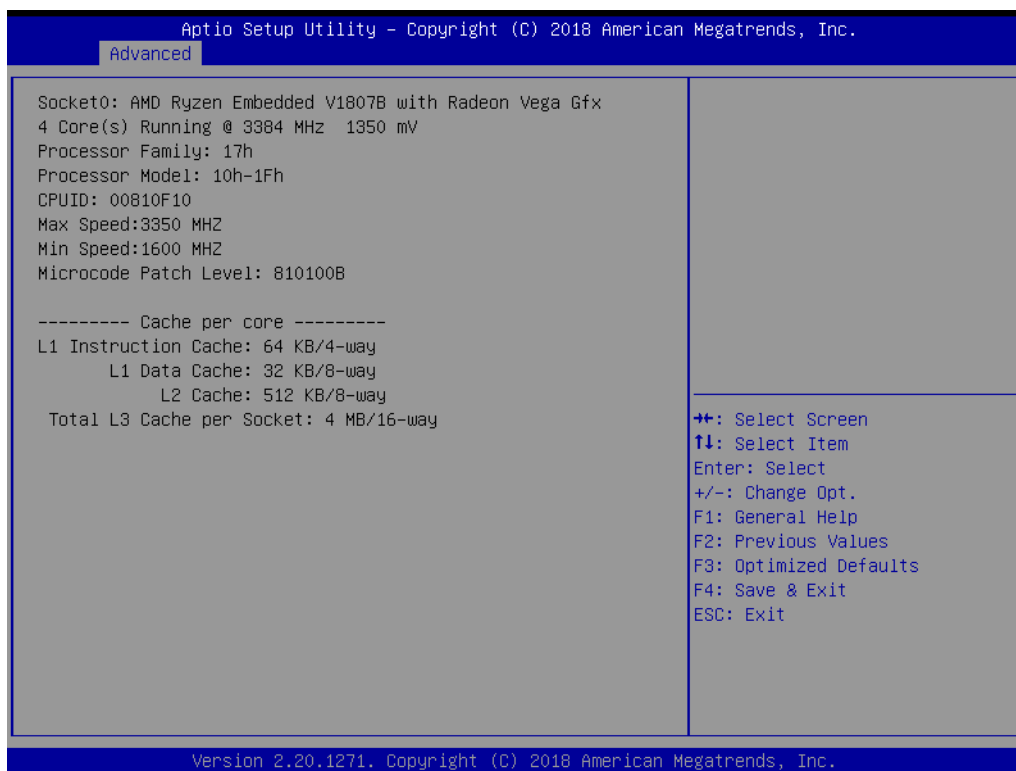

Feature	Options	Description
Socket0	No option	Shows the current status
Processor Family	No option	Shows the current status
Processor Model	No option	Shows the current status
CPUID	No option	Shows the current status
Max Speed	No option	Shows the current status
Min Speed	No option	Shows the current status
Microcode Patch Level	No option	Shows the current status
Catch per core	No option	Shows the current status

3.1.2.14 PCI Subsystem Settings

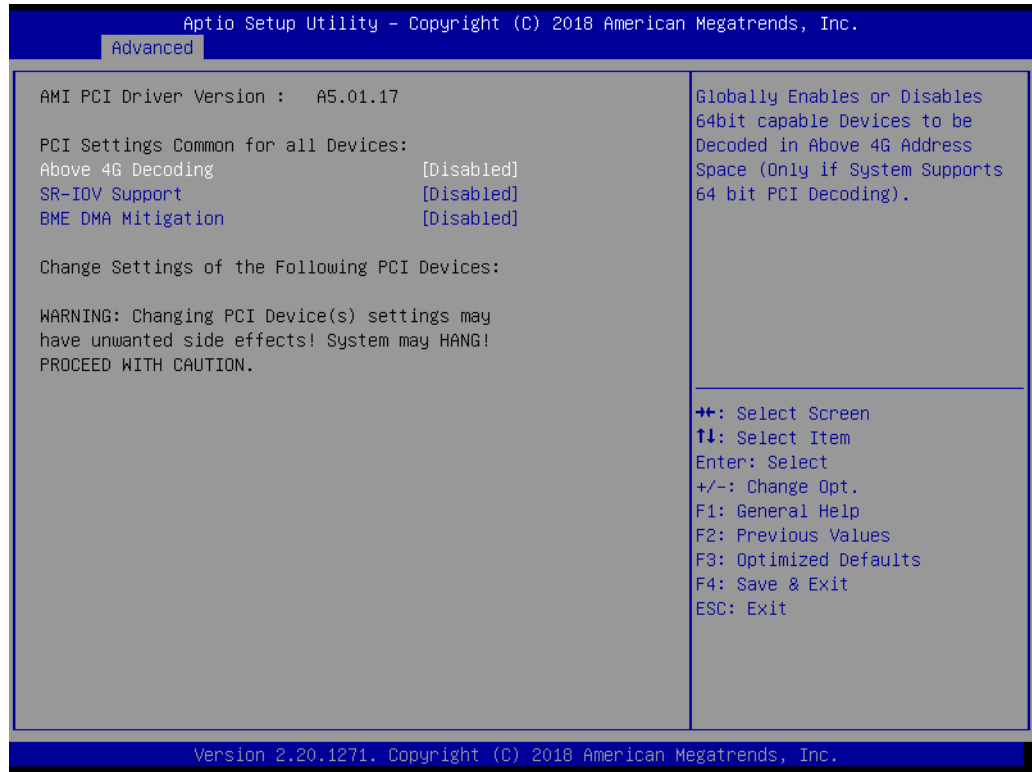

Feature	Options	Description
Above 4G Decoding	Disabled Enabled	Globally enables or disables 64-bit capable devices to be decoded in above 4G address space (only if the system supports 64-bit PCI decoding).
SR-IOV Support	Disabled Enabled	If the system has SR-IOV capable PCIe devices, this option enables or disables Single Root IO Virtualization Support.
BME DMA Mitigation	Disabled Enabled	Re-enable bus master attribute disabled during PCi enumeration for PCI bridges after SMM is locked.

3.1.2.15 Network Stack Configuration



Feature	Options	Description
Network Stack	Disabled Enabled	Enables/disables UEFI Network Stack

3.1.2.16 CSM Configuration

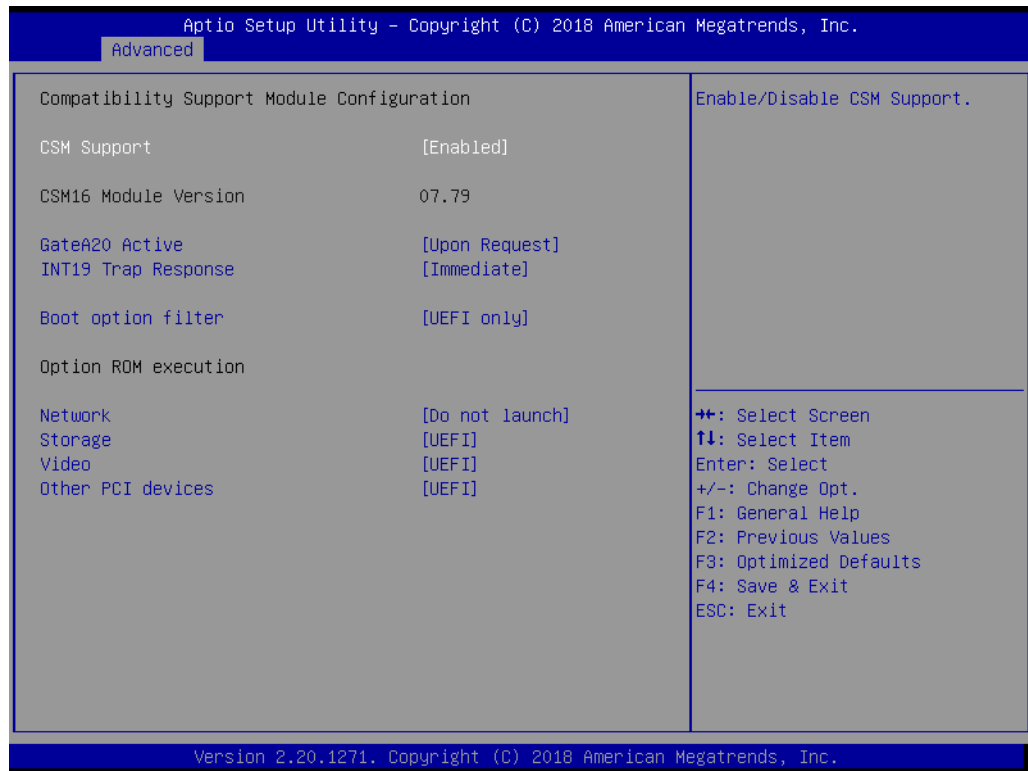

Feature	Options	Description
CSM Support	Disabled Enabled	Enable/disable CSM support.
Gate A20 Active	Upon Request Always	UPON REQUEST - GA20 can be disabled using BIOS services. ALWAYS - do not allow disabling GA20; this option is useful when any RT code is executed above 1MB.
INT19 Trap Response	Immediate Postponed	BIOS reaction on INT19 trapping by Option ROM: IMMEDIATE - execute the trap right away; POSTPONED - execute the trap during legacy boot.
Boot option filter	UEFI and Legacy Legacy only UEFI only	This option controls Legacy/UEFI ROMs priority
Network	Do not launch UEFI Legacy	Controls the execution of UEFI and Legacy PXE OpROM
Storage	Do not launch UEFI Legacy	Controls the execution of UEFI and Legacy Storage OpROM
Video	Do not launch UEFI Legacy	Controls the execution of UEFI and Legacy Video OpROM
Other PCI Devices	Do not launch UEFI Legacy	Determines OpROM execution policy for devices other than Network, Storage, or Video

Note!  *CSM: The Compatibility Support Module (CSM) is a component of the UEFI firmware that provides legacy BIOS compatibility by emulating a BIOS environment, allowing legacy operating systems and some option ROMs that do not support UEFI to still be used.*

CSM also provides required legacy System Management Mode (SMM) functionality, called CompatibilitySmm, as an addition to features provided by the UEFI SMM. This is optional and highly chipset- and platform-specific. An example of such a legacy SMM functionality is providing USB legacy support for keyboard and mouse, by emulating their classic PS/2 counterparts.

3.1.2.17 NVMe Configuration

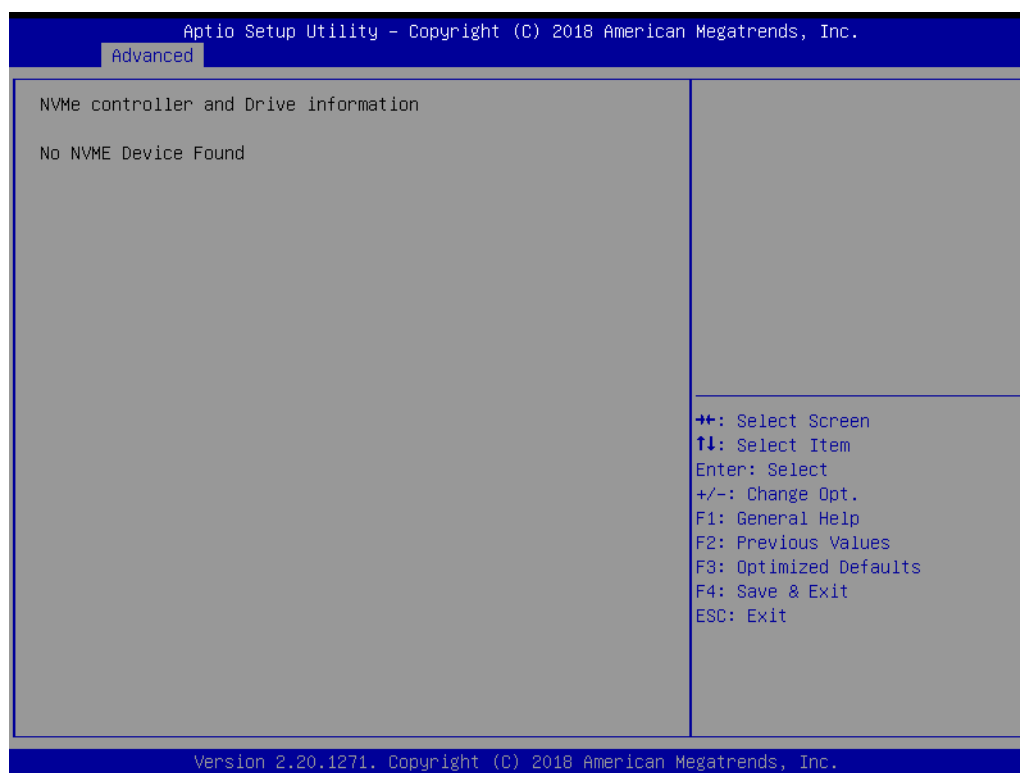

Feature	Options	Description
NVMe Device	No option	Shows the current status

3.1.2.18 USB Configuration

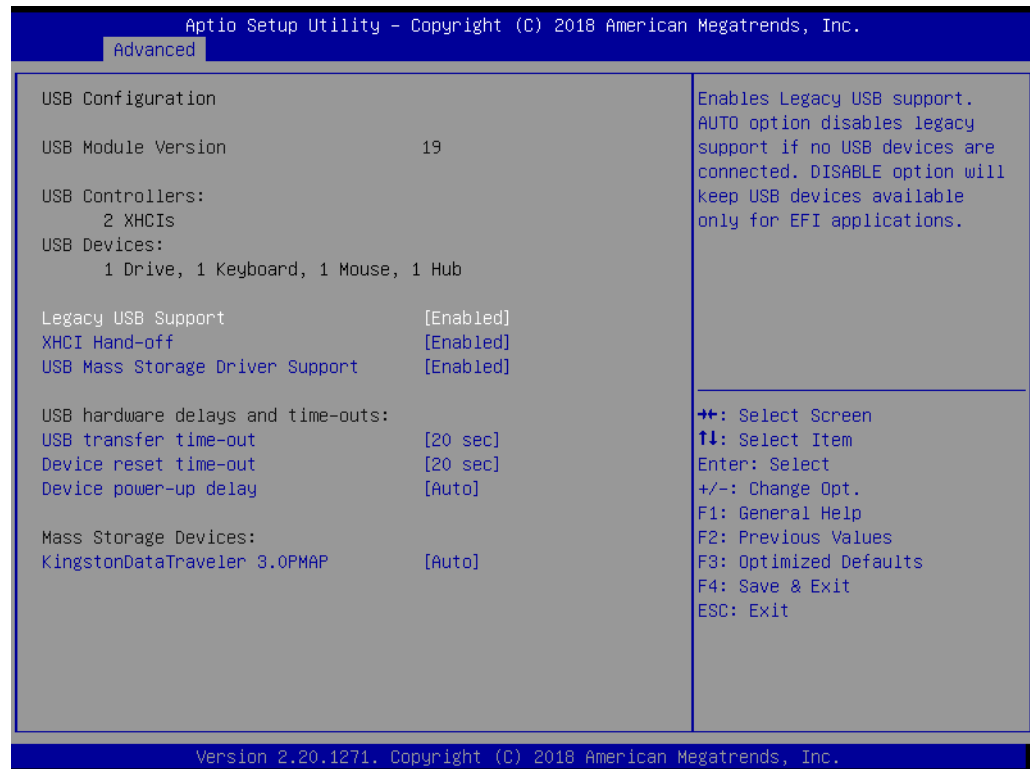

Feature	Options	Description
Legacy USB Support	Enabled Disabled Auto	Enables legacy USB support. AUTO option disables legacy support if no USB devices are connected. DISABLE option will keep USB devices available only for EFI applications.
XHCI Hand-off	Enabled Disabled	This is a workaround for OS without XHCI hand-off support. The XHCI ownership change should be claimed by XHCI driver.
USB Mass Storage Driver Support	Enabled Disabled	Enable/Disable USB mass storage driver support.
USB transfer time-out	1 sec 5 sec 10 sec 20 sec	The time-out value for control, bulk, and interrupt transfers.
Device reset time-out	10 sec 20 sec 30 sec 40 sec	USB mass storage device Start Unit command time-out.
Device power-up delay	Auto Manual	Maximum time the device will take before it properly reports itself to the host controller. 'Auto' uses default value: for a Root port it is 100 ms, for a Hub port the delay is taken from Hub descriptor.

3.1.3 Chipset

Select the **Chipset** tab from the **SOM-5871** setup screen to enter the Chipset BIOS Setup screen. You can display a Chipset BIOS Setup option by highlighting it using the <Arrow> keys. All Plug and Play BIOS Setup options are described in this section. The Plug and Play BIOS Setup screen is shown below.



Feature	Options	Description
South Bridge	<Sub Menu>	South bridge parameters
NXP3460 Configuration	<Sub Menu>	NXP3460 parameters
North Bridge	<Sub Menu>	North bridge parameters
BIOS Option Item	<Sub Menu>	Optional item for PCIe and display configuration setting

3.1.3.1 South Bridge

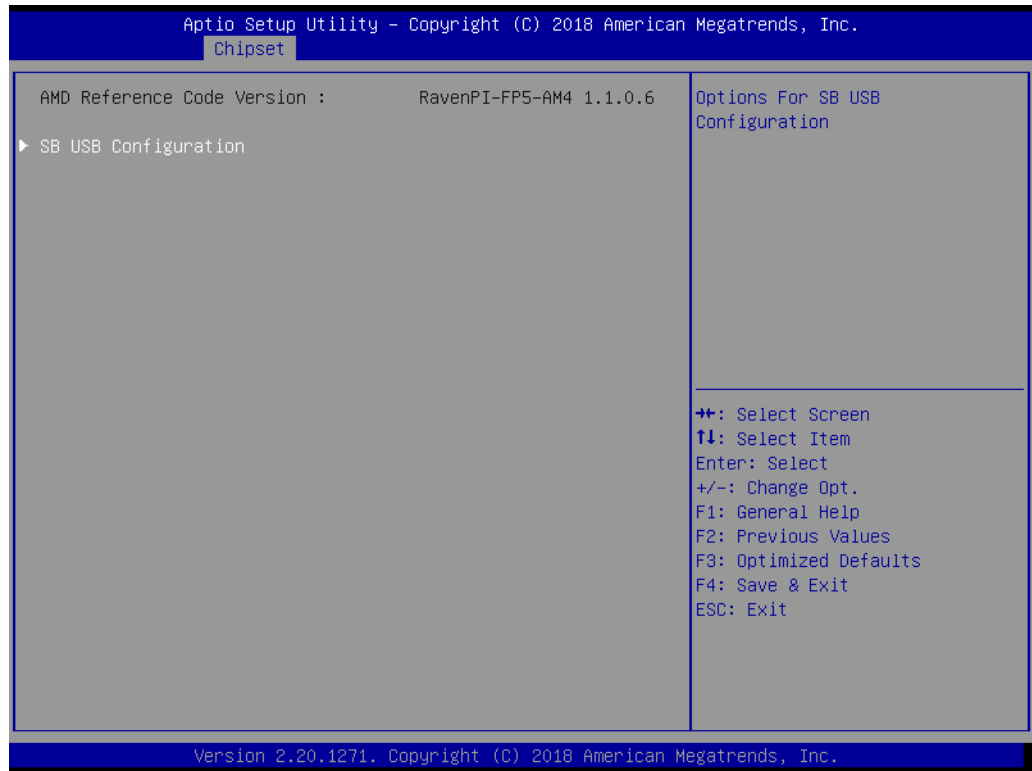

Feature	Options	Description
SB USB Configuration	<Sub Menu>	Options For SB USB Configuration

3.1.3.2 SB USB Configuration

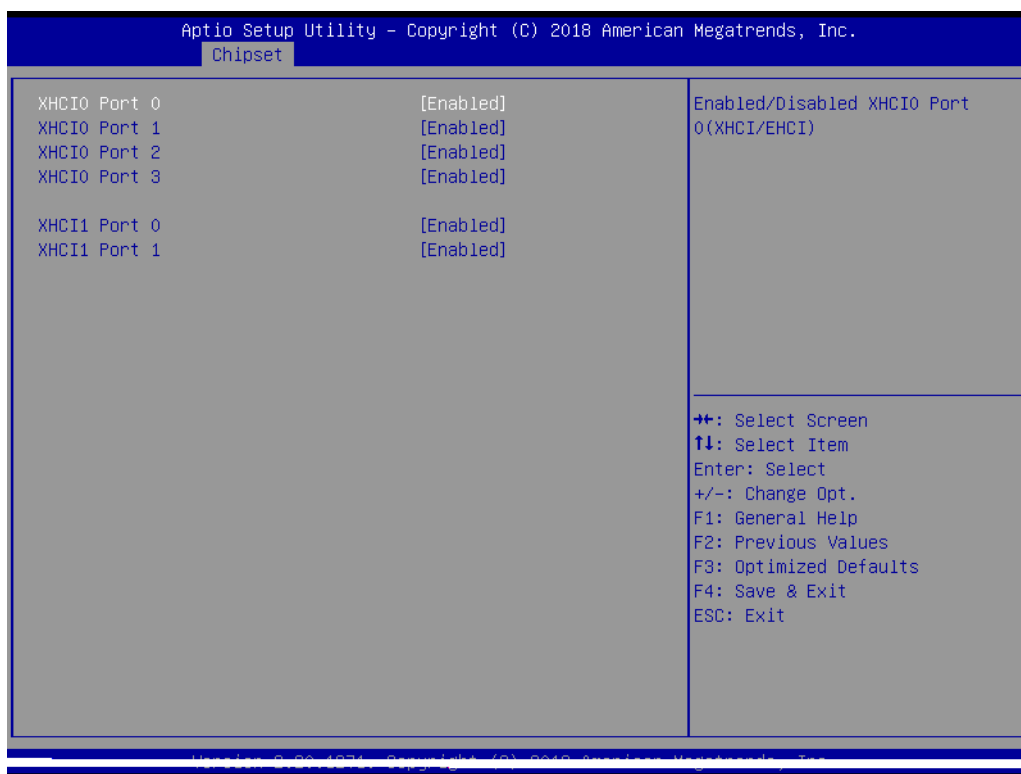

Feature	Options	Description
XHCI0 Port 0	Disabled Enabled	Enabled/Disabled XHCI0 Port 0(XHCI/EHCI)
XHCI0 Port 1	Disabled Enabled	Enabled/Disabled XHCI0 Port 1(XHCI/EHCI)
XHCI0 Port 2	Disabled Enabled	Enabled/Disabled XHCI0 Port 2(XHCI/EHCI)
XHCI0 Port 3	Disabled Enabled	Enabled/Disabled XHCI0 Port 3(XHCI/EHCI)
XHCI1 Port 0	Disabled Enabled	Enabled/Disabled XHCI1 Port 0(XHCI/EHCI)
XHCI1 Port 1	Disabled Enabled	Enabled/Disabled XHCI1 Port 1(EHCI)

3.1.3.3 NXP3460 Configuration

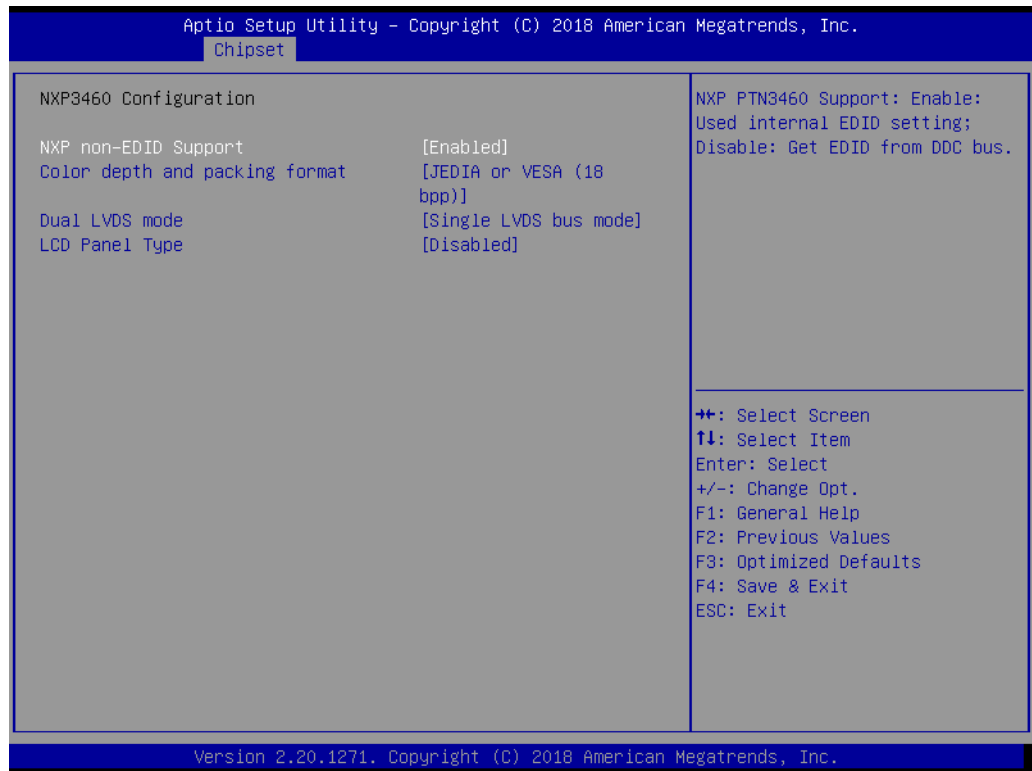

Feature	Options	Description
NXP non-EDID Support	Enabled Disabled	NXP PTN3460 Support: Enable: Used internal EDID setting; Disable: Get EDID from DDC bus.
Color depth and packing format	JEDIA or VESA (18 bpp) VESA (24 bpp)	Color depth and packing format
Dual LVDS mode	Single LVDS bus mode Dual LVDS bus mode	Dual LVDS mode
LCD Panel Type	800x600 1024x768 1280x1024 48bit 1680x1050 48bit 1600x1200 48bit 1920x1080 48bit Customize Disabled	

3.1.3.4 North Bridge Configuration

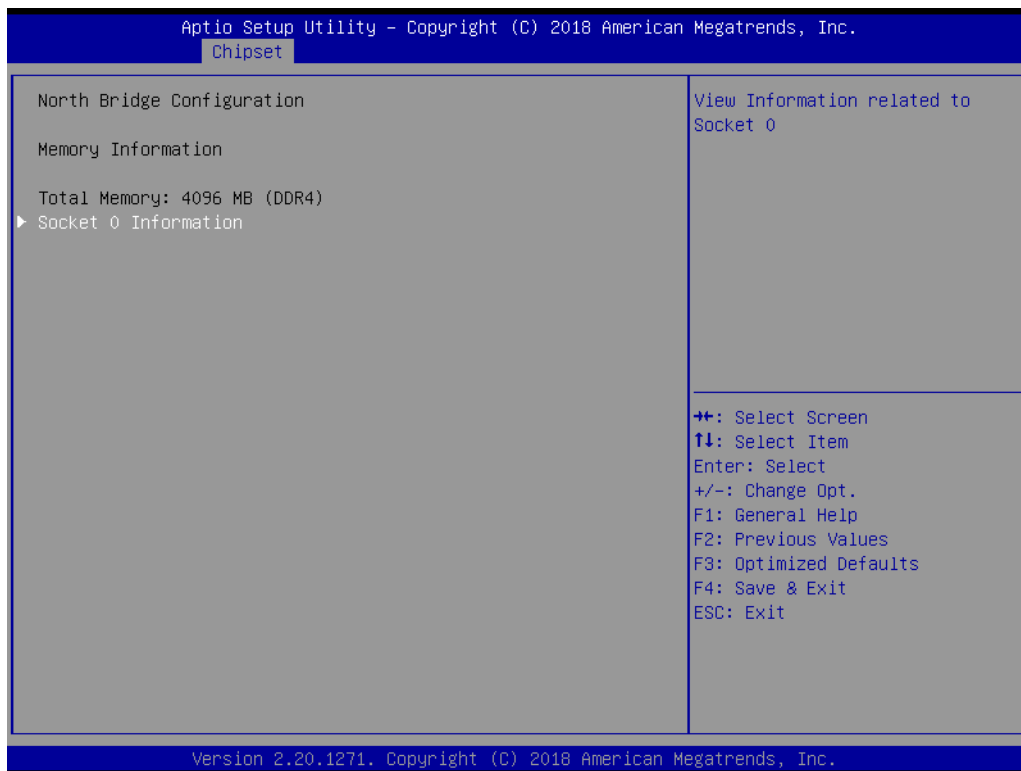

Feature	Options	Description
Socket 0 Information	<Sub Menu>	View Information related to Socket 0

3.1.3.5 Socket 0 Information

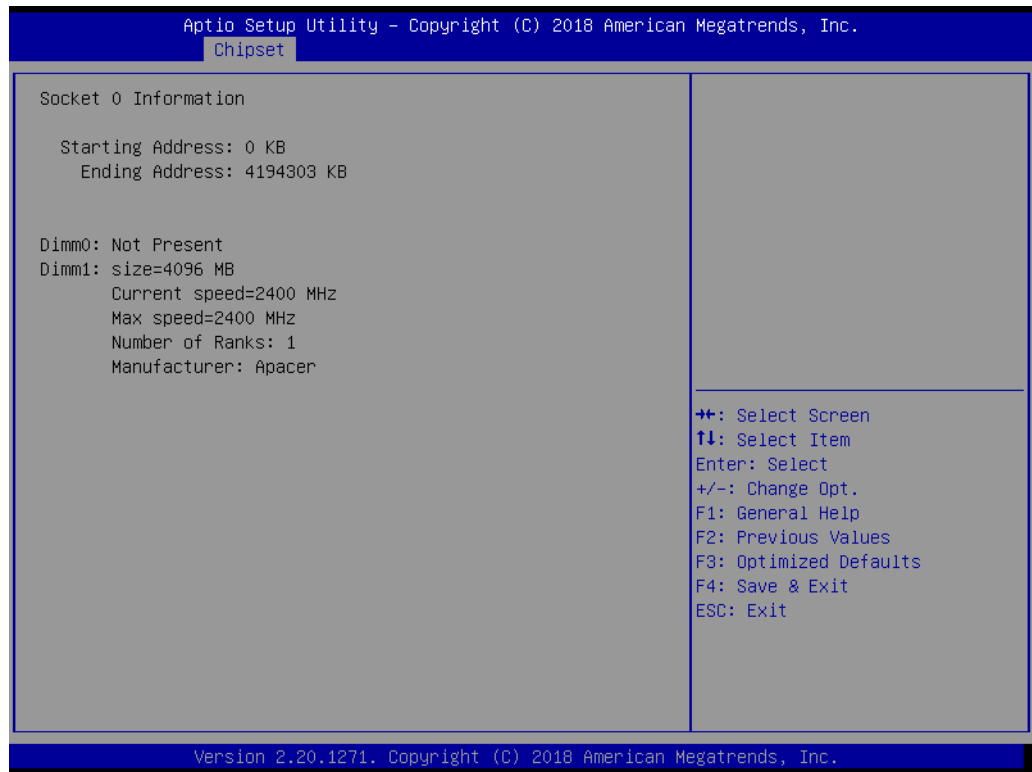

Feature	Options	Description
Starting Address	No option	Shows the current status
Ending Address	No option	Shows the current status
Dimm0	No option	Shows the current status
Dimm1	No option	Shows the current status

3.1.3.6 BIOS Option Item

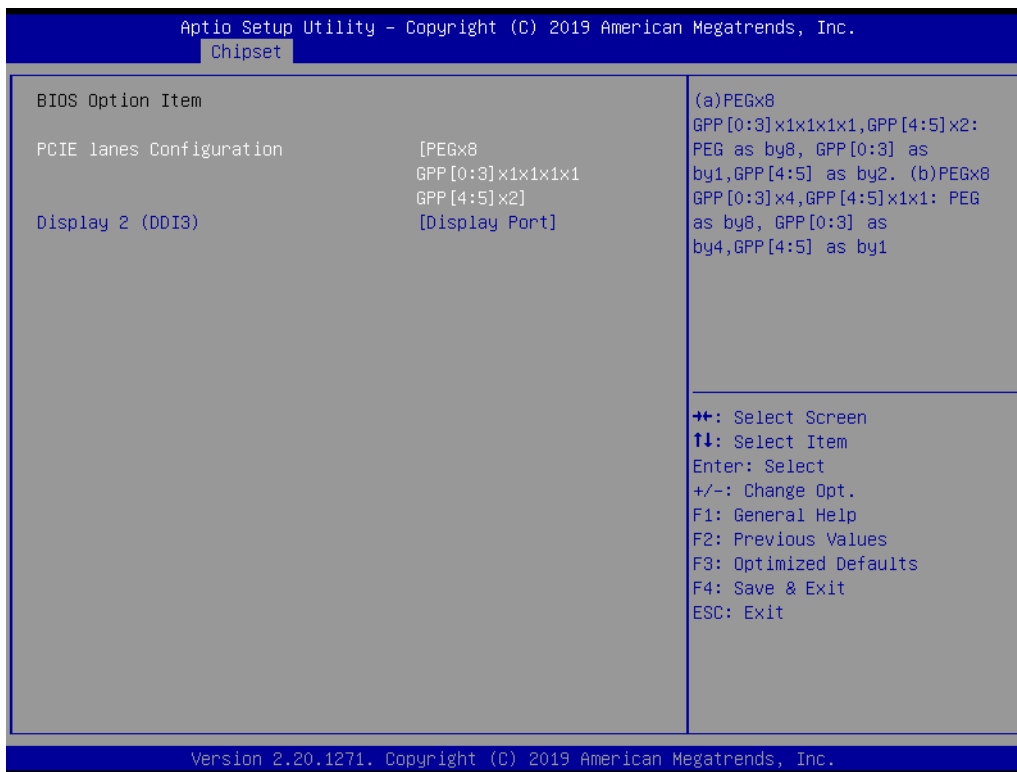

Feature	Options	Description
PCIE lanes Configuration	PEGx8 GPP[0:3]x1x1x1x1 GPP[4:5] x2 PEGx8 GPP[0:3]x4 GPP[4:5]x1x1	(a)PEGx8 GPP[0:3]x1x1x1x1,GPP[4:5]x2: PEG as by8, GPP[0:3] as by1,GPP[4:5] as by2. (b)PEGx8 GPP[0:3]x4,GPP[4:5]x1x1: PEG as by8, GPP[0:3] as by4,GPP[4:5] as by1
Display 2 (DDI3)	Display Port HDMI	Config Display Port 2 to Display Port or HDMI

3.1.4 Security

Select **Security** tab from the **SOM-5871** main BIOS setup menu. All security setup options, such as password protection are described in this section. To access the sub menu for the following items, select the item and press <Enter>:



Feature	Options	Description
Administrator Password	<Insert Password>	Set Administrator password
User Password	<Insert Password>	Set User password
Secure Boot	<Sub Menu>	Customizable secure boot settings

Change Administrator / User Password: Select this option and press Enter to access the sub menu, and then type in the password.

The password length is minimum 3 digits and maximum 20 digits.

If you set "Administrator Password" only, it will require a password only when entering the BIOS setup.

If you set "User Password" only, it will require a password every boot-up. However, if the Administrator password is not set, using "User Password" to enter the BIOS setup will permit all access privileges.

If you set both passwords, it will require a password every boot-up. To boot into the OS, you can use either password. To enter BIOS setup, "Administrator Password" gives all privileges to access all items, while "User Password" only gives partial privileges.

Note! *Please keep your password safe. For security reasons, the BIOS password can't be reset by clearing CMOS. If you forget your password, please contact Advantech for technical support.*



3.1.4.1 Secure Boot



Feature	Options	Description
Secure Boot	Disabled Enabled	Secure Boot active when: Secure Boot is enabled Platform Key (PK) is enrolled System mode is User/Deployed, and CSM is disabled
Secure Boot Customization	Standard Custom	Customizable Secure Boot mode: in Custom mode Secure Boot Policy variables can be configured by a physically present user without full authentication
Restore Factory Keys	Press Yes or No	Force System to User Mode. Configure NVRAM to contain OEM-defined factory default Secure Boot Keys
Reset to Setup Mode	<Sub Menu>	
Key Management	<Sub Menu>	Enables expert users to modify Secure Boot Policy variables without full authentication

3.1.4.2 Key Management

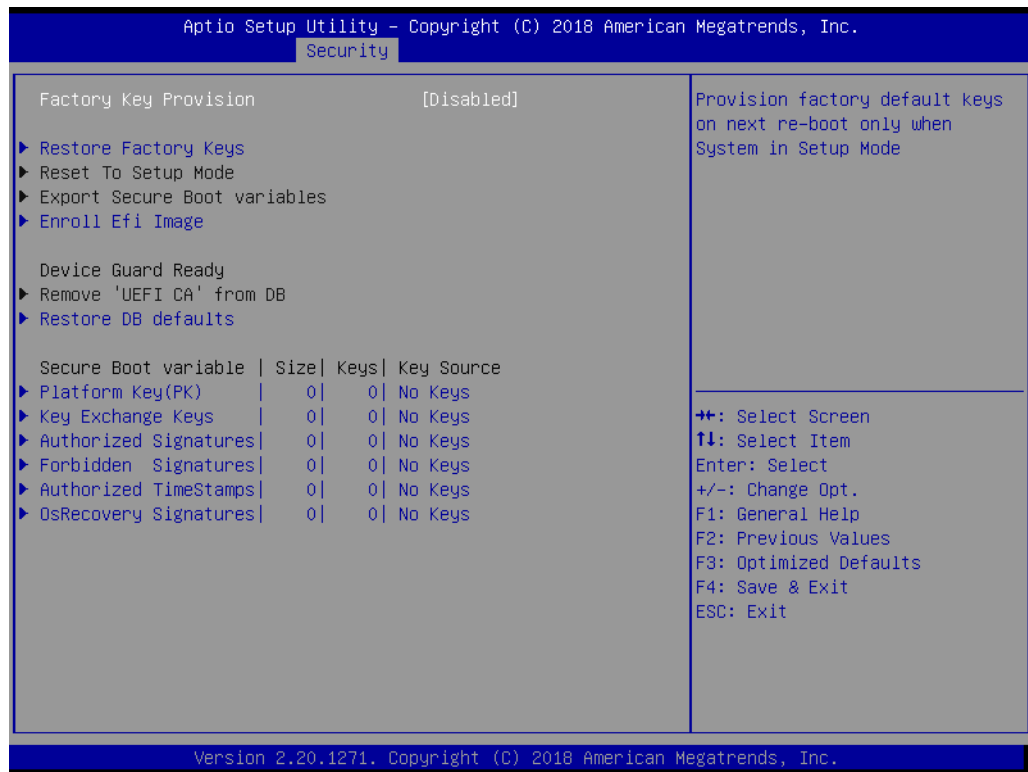

Feature	Options	Description
Factory Key Provision	Disabled Enabled	Provision factory default keys on next re-boot only when system in Setup Mode
Restore Factory Keys	Press Yes or No	Force system to User Mode. Configure NVRAM to contain OEM-defined factory default secure boot keys
Enroll Efi Image	Check Valid File System Available or not	Allow the image to run in Secure Boot mode. Enroll SHA256 Hash certificate of a PE image into Authorized Signature Database (db)
Restore DB defaults	Press Yes or No	Restore DB variable to factory defaults
Platform Key(PK)	Update Append	Enroll factory defaults or load certificates from a file: <ol style="list-style-type: none"> Public Key Certificate in: <ol style="list-style-type: none"> EFI_SIGNATURE_LIST, b) EFI_CERT_X509(DER), c) EFI_CERT_RSA2048 (bin), d) EFI_CERT_SHA256, 384, 512 Authenticated UEFI Variable EFI PE/COFF Image (SHA256) Key Source: Factory, External, Mixed

Key Exchange Keys	Update Append	<p>Enroll Factory Defaults or load certificates from a file:</p> <ol style="list-style-type: none"> Public Key Certificate in: <ol style="list-style-type: none"> EFI_SIGNATURE_LIST, b) EFI_CERT_X509(DER), c) EFI_CERT_RSA2048 (bin), d) EFI_CERT_SHA256, 384, 512 Authenticated UEFI Variable EFI PE/COFF Image (SHA256) <p>Key Source: Factory, External, Mixed</p>
Authorized Signatures	Update Append	<p>Enroll Factory Defaults or load certificates from a file:</p> <ol style="list-style-type: none"> Public Key Certificate in: <ol style="list-style-type: none"> EFI_SIGNATURE_LIST, b) EFI_CERT_X509(DER), c) EFI_CERT_RSA2048 (bin), d) EFI_CERT_SHA256, 384, 512 Authenticated UEFI Variable EFI PE/COFF Image (SHA256) <p>Key Source: Factory, External, Mixed</p>
Forbidden Signatures	Update Append	<p>Enroll Factory Defaults or load certificates from a file:</p> <ol style="list-style-type: none"> Public Key Certificate in: <ol style="list-style-type: none"> EFI_SIGNATURE_LIST, b) EFI_CERT_X509(DER), c) EFI_CERT_RSA2048 (bin), d) EFI_CERT_SHA256, 384, 512 Authenticated UEFI Variable EFI PE/COFF Image (SHA256) <p>Key Source: Factory, External, Mixed</p>
Authorized TimeStamps	Update Append	<p>Enroll Factory Defaults or load certificates from a file:</p> <ol style="list-style-type: none"> Public Key Certificate in: <ol style="list-style-type: none"> EFI_SIGNATURE_LIST, b) EFI_CERT_X509(DER), c) EFI_CERT_RSA2048 (bin), d) EFI_CERT_SHA256, 384, 512 Authenticated UEFI Variable EFI PE/COFF Image (SHA256) <p>Key Source: Factory, External, Mixed</p>
OsRecovery Signatures	Update Append	<p>Enroll Factory Defaults or load certificates from a file:</p> <ol style="list-style-type: none"> Public Key Certificate in: <ol style="list-style-type: none"> EFI_SIGNATURE_LIST, b) EFI_CERT_X509(DER), c) EFI_CERT_RSA2048 (bin), d) EFI_CERT_SHA256, 384, 512 Authenticated UEFI Variable EFI PE/COFF Image (SHA256) <p>Key Source: Factory, External, Mixed</p>

3.1.5 Boot Settings



Feature	Options	Description
Setup Prompt Timeout	<insert number>	Number of seconds to wait for setup activation key. 65535(0xFFFF) means indefinite waiting.
Bootup NumLock State	On Off	Select the keyboard NumLock state
Quiet Boot	Disabled Enabled	Enables or disables Quiet Boot option
Fast Boot	Disabled Enabled	Enables or disables boot with initialization of a minimal set of devices required to launch active boot option. Has no effect for BBS boot options.
New Boot Option Policy	Default Place First Place Last	Controls the placement of newly detected UEFI boot options

Note! These items will be hidden when "Fast Boot" is disabled.



3.1.6 Save & Exit

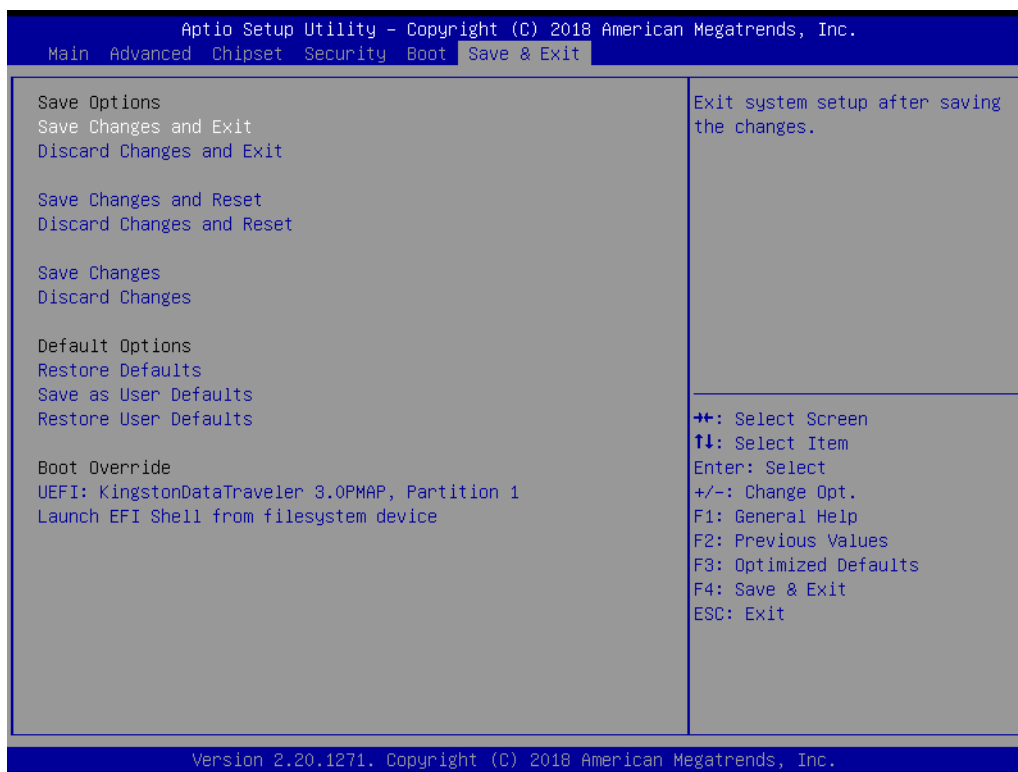

Feature	Options	Description
Save Changes and Exit	Yes No	Exit system setup after saving the changes.
Discard Changes and Exit	Yes No	Exit system setup without saving any changes.
Save Changes and Reset	Yes No	Reset the system after saving the changes.
Discard Changes and Reset	Yes No	Reset system setup without saving any changes.
Save Changes	Yes No	Save Changes done so far to any of the setup options.
Discard Changes	Yes No	Discard changes done so far to any of the setup options.
Restore Defaults	Yes No	Restore/Load Default values for all the setup options.
Save as User Defaults	Yes No	Save the changes done so far as User Defaults.
Restore User Defaults	Yes No	Restore the User Defaults to all the setup options.
Launch EFI Shell from file system device	Yes No	Attempts to Launch EFI Shell application (Shell.efi) from one of the available file system devices

Chapter 4

S/W Introduction & Installation

- S/W Introduction
- Driver Installation
- Advantech iManager

4.1 S/W Introduction

The mission of Advantech Embedded Software Services is to "Enhance quality of life with Advantech platforms and Microsoft Windows embedded technology." We enable Windows Embedded software products on Advantech platforms to more effectively support the embedded computing community. Customers are freed from the hassle of dealing with multiple vendors (Hardware suppliers, System integrators, Embedded OS distributor) for projects. Our goal is to make Windows Embedded Software solutions easily and widely available to the embedded computing community.

4.2 Driver Installation

The Intel Chipset Software Installation (CSI) utility installs the Windows INF files that outline to the operating system how the chipset components will be configured.

4.2.1 Windows Driver Setup

To install the drivers on a windows-based operation system, please connect to internet and browse the website <http://support.advantech.com.tw> and download the drivers that you want to install and follow Driver Setup instructions to complete the installation.

4.2.2 Other OS

SOM-5871 supports Linux:

Ubuntu-16.04.1-desktop-AMD 64bit

4.3 Advantech iManager

Advantech's platforms come equipped with iManager, a micro controller that provides embedded features for system integrators. Embedded features have been moved from the OS/BIOS level to the board level, to increase reliability and simplify integration.

iManager runs whether the operating system is running or not; it can count the boot times and running hours of the device, monitor device health, and provide an advanced watchdog to handle errors just as they happen. iManager also comes with a secure & encrypted EEPROM for storing important security key or other customer define information. All the embedded functions are configured through API and provide corresponding utilities to demonstrate. These APIs comply with PICMG EAPI (Embedded Application Programmable Interface) specification and unify in the same structures. It makes these embedded features easier to integrate, speed up development schedule, and provide the customer's software continuity while upgrade hardware. More details of how to use the APIs and utilities, please refer to Advantech iManager 2.0 Software API User Manual.

Control



GPIO

General Purpose Input/Output is a flexible parallel interface that allows a variety of custom connections. It allows users to monitor the level of signal input or set the output status to switch on/off a device. Our API also provides Programmable GPIO, which allows developers to dynamically set the GPIO input or output status.



SMBus

SMBus is the System Management Bus defined by Intel® Corporation in 1995. It is used in personal computers and servers for low-speed system management communications. The SMBus API allows a developer to interface a embedded system environment and transfer serial messages using the SMBus protocols, allowing multiple simultaneous device control.



I2C

I2C is a bi-directional two wire bus that was developed by Philips for use in their televisions in the 1980s. The I2C API allows a developer to interface with an embedded system environment and transfer serial messages using the I2C protocols, allowing multiple simultaneous device control.

Display



Brightness Control

The Brightness Control API allows a developer to interface with an embedded device to easily control brightness.



Backlight

The Backlight API allows a developer to control the backlight (screen) on/off in an embedded device.

Monitor



Watchdog

A watchdog timer (WDT) is a device that performs a specific operation after a certain period of time if something goes wrong and the system does not recover on its own. A watchdog timer can be programmed to perform a warm boot (restarting the system) after a certain number of seconds.



Hardware Monitor

The Hardware Monitor (HWM) API is a system health supervision API that inspects certain condition indexes, such as fan speed, temperature and voltage.



Hardware Control

The Hardware Control API allows developers to set the PWM (Pulse Width Modulation) value to adjust fan speed or other devices; it can also be used to adjust the LCD brightness.

Power Saving



CPU Speed

Make use of Intel SpeedStep technology to reduce power power consumption. The system will automatically adjust the CPU Speed depending on system loading.



System Throttling

Refers to a series of methods for reducing power consumption in computers by lowering the clock frequency. These APIs allow the user to lower the clock from 87.5% to 12.5%.

Appendix **A**

Pin Assignment

This appendix gives you the information about the hardware pin assignment of the SOM-5871 CPU System on Module

Sections include:

- SOM-5871 Type 6 Pin Assignment

A.1 SOM-5871 Type 6 Pin Assignment

This section gives SOM-5871 pin assignment on COM Express connector which compliant with COMR.0 R3.0 Type 6 pin-out definitions. More details about how to use these pins and get design reference. Please contact to Advantech for design guide, checklist, reference schematic, and other hardware/software supports.

SOM-5871 Row A,B			
A1	GND (FIXED)	B1	GND (FIXED)
A2	GBE0_MDI3-	B2	GBE0_ACT#
A3	GBE0_MDI3+	B3	LPC_FRAME#
A4	GBE0_LINK100#	B4	LPC_AD0
A5	GBE0_LINK1000#	B5	LPC_AD1
A6	GBE0_MDI2-	B6	LPC_AD2
A7	GBE0_MDI2+	B7	LPC_AD3
A8	GBE0_LINK#	B8	N/A
A9	GBE0_MDI1-	B9	N/A
A10	GBE0_MDI1+	B10	LPC_CLK
A11	GND (FIXED)	B11	GND (FIXED)
A12	GBE0_MDI0-	B12	PWRBTN#
A13	GBE0_MDI0+	B13	SMB_CK
A14	N/A	B14	SMB_DAT
A15	SUS_S3#	B15	SMB_ALERT#
A16	SATA0_TX+	B16	SATA1_TX+
A17	SATA0_TX-	B17	SATA1_TX-
A18	SUS_S5#	B18	SUS_STAT#
A19	SATA0_RX+	B19	SATA1_RX+
A20	SATA0_RX-	B20	SATA1_RX-
A21	GND (FIXED)	B21	GND (FIXED)
A22	N/A	B22	N/A
A23	N/A	B23	N/A
A24	SUS_S5#	B24	PWR_OK
A25	N/A	B25	N/A
A26	N/A	B26	N/A
A27	BATLOW#	B27	WDT
A28	(S)ATA_ACT#	B28	HDA_SDIN2
A29	HDA_SYNC	B29	HDA_SDIN1
A30	HDA_RST#	B30	HDA_SDIN0
A31	GND (FIXED)	B31	GND (FIXED)
A32	HDA_BITCLK	B32	SPKR
A33	HDA_SDOUT	B33	I2C_CK
A34	BIOS_DIS0#	B34	I2C_DAT
A35	THRMTRIP#	B35	THRM#
A36	USB6-	B36	USB7-
A37	USB6+	B37	USB7+
A38	USB_6_7_OC#	B38	USB_4_5_OC#
A39	USB4-	B39	USB5-
A40	USB4+	B40	USB5+

A41	GND (FIXED)	B41	GND (FIXED)
A42	USB2-	B42	USB3-
A43	USB2+	B43	USB3+
A44	USB_2_3_OC#	B44	USB_0_1_OC#
A45	USB0-	B45	USB1-
A46	USB0+	B46	USB1+
A47	VCC_RTC	B47	N/A
A48	RSVD	B48	N/A
A49	GBE0_SDP	B49	SYS_RESET#
A50	LPC_SERIRQ	B50	CB_RESET#
A51	GND (FIXED)	B51	GND (FIXED)
A52	N/A	B52	N/A
A53	N/A	B53	N/A
A54	GPI0	B54	GPO1
A55	PCIE_TX4+	B55	PCIE_RX4+
A56	PCIE_TX4-	B56	PCIE_RX4-
A57	GND	B57	GPO2
A58	PCIE_TX3+	B58	PCIE_RX3+
A59	PCIE_TX3-	B59	PCIE_RX3-
A60	GND (FIXED)	B60	GND (FIXED)
A61	PCIE_TX2+	B61	PCIE_RX2+
A62	PCIE_TX2-	B62	PCIE_RX2-
A63	GPI1	B63	GPO3
A64	PCIE_TX1+	B64	PCIE_RX1+
A65	PCIE_TX1-	B65	PCIE_RX1-
A66	GND	B66	WAKE0#
A67	GPI2	B67	WAKE1#
A68	PCIE_TX0+	B68	PCIE_RX0+
A69	PCIE_TX0-	B69	PCIE_RX0-
A70	GND (FIXED)	B70	GND (FIXED)
A71	LVDS_A0+	B71	LVDS_B0+
A72	LVDS_A0-	B72	LVDS_B0-
A73	LVDS_A1+	B73	LVDS_B1+
A74	LVDS_A1-	B74	LVDS_B1-
A75	LVDS_A2+	B75	LVDS_B2+
A76	LVDS_A2-	B76	LVDS_B2-
A77	LVDS_VDD_EN	B77	LVDS_B3+
A78	LVDS_A3+	B78	LVDS_B3-
A79	LVDS_A3-	B79	LVDS_BKLT_EN
A80	GND (FIXED)	B80	GND (FIXED)
A81	LVDS_A_CK+	B81	LVDS_B_CK+
A82	LVDS_A_CK-	B82	LVDS_B_CK-
A83	LVDS_I2C_CK	B83	LVDS_BKLT_CTRL
A84	LVDS_I2C_DAT	B84	VCC_5V_SBY
A85	GPI3	B85	VCC_5V_SBY
A86	RSVD	B86	VCC_5V_SBY
A87	N/A	B87	VCC_5V_SBY
A88	PCIE_CLK_REF+	B88	BIOS_DIS1#

A89	PCIE_CLK_REF-	B89	VGA_RED
A90	GND (FIXED)	B90	GND (FIXED)
A91	SPI_POWER	B91	VGA_GRN
A92	SPI_MISO	B92	VGA_BLU
A93	GPO0	B93	VGA_HSYNC
A94	SPI_CLK	B94	VGA_VSYNC
A95	SPI_MOSI	B95	VGA_I2C_CK
A96	TPM_PP	B96	VGA_I2C_DAT
A97	N/A	B97	SPI_CS#
A98	SER0_TX	B98	RSVD
A99	SER0_RX	B99	RSVD
A100	GND (FIXED)	B100	GND (FIXED)
A101	SER1_TX	B101	FAN_PWMOUT
A102	SER1_RX	B102	FAN_TACHIN
A103	LID#	B103	SLEEP#
A104	VCC_12V	B104	VCC_12V
A105	VCC_12V	B105	VCC_12V
A106	VCC_12V	B106	VCC_12V
A107	VCC_12V	B107	VCC_12V
A108	VCC_12V	B108	VCC_12V
A109	VCC_12V	B109	VCC_12V
A110	GND (FIXED)	B110	GND (FIXED)

SOM-5871 Row C,D

C1	GND (FIXED)	D1	GND (FIXED)
C2	GND	D2	GND
C3	USB_SSRX0-	D3	USB_SSTX0-
C4	USB_SSRX0+	D4	USB_SSTX0+
C5	GND	D5	GND
C6	USB_SSRX1-	D6	USB_SSTX1-
C7	USB_SSRX1+	D7	USB_SSTX1+
C8	GND	D8	GND
C9	USB_SSRX2-	D9	USB_SSTX2-
C10	USB_SSRX2+	D10	USB_SSTX2+
C11	GND (FIXED)	D11	GND (FIXED)
C12	N/A	D12	N/A
C13	N/A	D13	N/A
C14	GND	D14	GND
C15	N/A	D15	DDI1_CTRLCLK_AUX+
C16	N/A	D16	DDI1_CTRLDATA_AUX-
C17	RSVD	D17	RSVD
C18	RSVD	D18	RSVD
C19	PCIE_RX6+	D19	PCIE_TX6+
C20	PCIE_RX6-	D20	PCIE_TX6-
C21	GND (FIXED)	D21	GND (FIXED)
C22	N/A	D22	N/A
C23	N/A	D23	N/A
C24	DDI1_HPDP	D24	RSVD

C25	N/A	D25	RSVD
C26	N/A	D26	DDI1_PAIR0+
C27	RSVD	D27	DDI1_PAIR0-
C28	RSVD	D28	RSVD
C29	N/A	D29	DDI1_PAIR1+
C30	N/A	D30	DDI1_PAIR1-
C31	GND (FIXED)	D31	GND (FIXED)
C32	DDI2_CTRLCLK_AUX+	D32	DDI1_PAIR2+
C33	DDI2_CTRLCLK_AUX-	D33	DDI1_PAIR2-
C34	DDI2_DDC_AUX_SEL	D34	DDI1_DDC_AUX_SEL
C35	RSVD	D35	RSVD
C36	N/A	D36	DDI1_PAIR3+
C37	N/A	D37	DDI1_PAIR3-
C38	N/A	D38	RSVD
C39	N/A	D39	DDI2_PAIR0+
C40	N/A	D40	DDI2_PAIR0-
C41	GND (FIXED)	D41	GND (FIXED)
C42	N/A	D42	DDI2_PAIR1+
C43	N/A	D43	DDI2_PAIR1-
C44	N/A	D44	DDI2_HPDP
C45	RSVD	D45	RSVD
C46	N/A	D46	DDI2_PAIR2+
C47	N/A	D47	DDI2_PAIR2-
C48	RSVD	D48	RSVD
C49	N/A	D49	DDI2_PAIR3+
C50	N/A	D50	DDI2_PAIR3-
C51	GND (FIXED)	D51	GND (FIXED)
C52	PEG_RX0+	D52	PEG_TX0+
C53	PEG_RX0-	D53	PEG_TX0-
C54	N/A	D54	PEG_LANE_RV#
C55	PEG_RX1+	D55	PEG_TX1+
C56	PEG_RX1-	D56	PEG_TX1-
C57	N/A	D57	GND
C58	PEG_RX2+	D58	PEG_TX2+
C59	PEG_RX2-	D59	PEG_TX2-
C60	GND (FIXED)	D60	GND (FIXED)
C61	PEG_RX3+	D61	PEG_TX3+
C62	PEG_RX3-	D62	PEG_TX3-
C63	RSVD	D63	RSVD
C64	RSVD	D64	RSVD
C65	PEG_RX4+	D65	PEG_TX4+
C66	PEG_RX4-	D66	PEG_TX4-
C67	RAPID_SHUTDOWN	D67	GND
C68	PEG_RX5+	D68	PEG_TX5+
C69	PEG_RX5-	D69	PEG_TX5-
C70	GND (FIXED)	D70	GND (FIXED)
C71	PEG_RX6+	D71	PEG_TX6+
C72	PEG_RX6-	D72	PEG_TX6-

C73	GND	D73	GND
C74	PEG_RX7+	D74	PEG_TX7+
C75	PEG_RX7-	D75	PEG_TX7-
C76	GND	D76	GND
C77	RSVD	D77	RSVD
C78	N/A	D78	N/A
C79	N/A	D79	N/A
C80	GND (FIXED)	D80	GND (FIXED)
C81	N/A	D81	N/A
C82	N/A	D82	N/A
C83	RSVD	D83	RSVD
C84	GND	D84	GND
C85	N/A	D85	N/A
C86	N/A	D86	N/A
C87	GND	D87	GND
C88	N/A	D88	N/A
C89	N/A	D89	N/A
C90	GND (FIXED)	D90	GND (FIXED)
C91	N/A	D91	N/A
C92	N/A	D92	N/A
C93	GND	D93	GND
C94	N/A	D94	N/A
C95	N/A	D95	N/A
C96	GND	D96	GND
C97	RSVD	D97	RSVD
C98	N/A	D98	N/A
C99	N/A	D99	N/A
C100	GND (FIXED)	D100	GND (FIXED)
C101	N/A	D101	N/A
C102	N/A	D102	N/A
C103	GND	D103	GND
C104	VCC_12V	D104	VCC_12V
C105	VCC_12V	D105	VCC_12V
C106	VCC_12V	D106	VCC_12V
C107	VCC_12V	D107	VCC_12V
C108	VCC_12V	D108	VCC_12V
C109	VCC_12V	D109	VCC_12V
C110	GND (FIXED)	D110	GND (FIXED)

Appendix **B**

Watchdog Timer

This appendix gives you the information about the watchdog timer programming on the SOM-5871 CPU System on Module

Sections include:

- Watchdog Timer Programming

B.1 Programming the Watchdog Timer

Trigger Event	Note
IRQ	(BIOS setting default disable)**
NMI	N/A
SCI	Power button event
Power Off	Support
H/W Restart	Support
WDT Pin Activate	Support

** WDT new driver support automatically select available IRQ number from BIOS, and then set to EC. Only Win10 support it.

In other OS, it will still use IRQ number from BIOS setting as usual.

For details, please refer to iManager & Software API User Manual.

Appendix **C**

Programming GPIO

This Appendix gives the illustration of the General Purpose Input and Output pin setting.

Sections include:

- System I/O ports

C.1 GPIO Register

GPIO Byte Mapping	H/W Pin Name
BIT0	GPO0
BIT1	GPO1
BIT2	GPO2
BIT3	GPO3
BIT4	GPI0
BIT5	GPI1
BIT6	GPI2
BIT7	GPI3

For details, please refer to iManager & Software API User Manual.

Appendix **D**

System Assignments

This appendix gives you the information about the system resource allocation on the SOM-5871 CPU System on Module

Sections include:

- System I/O ports
- DMA Channel Assignments
- Interrupt Assignments
- 1st MB Memory Map

All System Assignments are based on AMD Ryzen V1807B, Radeon(TM) Vega 11 Graphics.

D.1 System I/O Ports

Table D.1: System I/O ports

Addr.Range(Hex)	Device
0000-03AF	Direct memory access controller
0000-03AF	PCI Express Root Complex
0010-001F	Motherboard resources
0020-0021	Programmable interrupt controller
0022-003F	Motherboard resources
0040-0043	System timer OK
0060-006F	Motherboard resources
0061-0061	System speaker
0062-0062	Microsoft ACPI-Compliaedded Controller
0063-0063	Motherboard resources
0065-0065	Motherboard resources
0066-0066	Microsoft ACPI-Compliant Embedded Controller
0067-006F	Motherboard resources
0070-0071	System CMOS/real time clock
0072-007F	Motherboard resources
0080-0080	Motherboard resources
0081-0083	Direct memory access controller
0084-0086	Motherboard resources
0087-0087	Direct memory access controller
0088-0088	Motherboard resources
0089-008B	Direct memory access controller
008C-008E	Motherboard resources
008F-008F	Direct memory access controller
0090-009F	Motherboard resources
00A0-00A1	Programmable interrupt controller
00A2-00BF	Motherboard resources
00B1-00B1	Motherboard resources
00C0-00DF	Direct memory access controller
00E0-00EF	Motherboard resources
0200-027F	Motherboard resources
0200-027F	Motherboard resources
0280-028F	Motherboard resources
0280-028F	Motherboard resources
0290-029F	Motherboard resources
0299-029A	Motherboard resources
029E-02AD	Motherboard resources
02A0-02BF	Motherboard resources
02A0-02BF	Motherboard resources
02C0-02DF	Motherboard resources

Table D.1: System I/O ports

02F0-02F7	Motherboard resources
02F8-02FF	Communications Port (COM2)
0300-037F	Motherboard resources
03B0-03DF	PCI Express Root Complex
03E0-0CF7	PCI Express Root Complex
03F8-03FF	Communications Port (COM1)
040B-040B	Motherboard resources
04D0-04D1	Motherboard resources
04D6-04D6	Motherboard resources
0800-089F	Motherboard resources
0900-090F	Motherboard resources
0910-091F	Motherboard resources
0B00-0B0F	Motherboard resources
0B20-0B3F	Motherboard resources
0C00-0C01	Motherboard resources
0C14-0C14	Motherboard resources
0C50-0C51	Motherboard resources
0C52-0C52	Motherboard resources
0C6C-0C6C	Motherboard resources
0C6F-0C6F	Motherboard resources
0CD0-0CD1	Motherboard resources
0CD2-0CD3	Motherboard resources
0CD4-0CD5	Motherboard resources
0CD6-0CD7	Motherboard resources
0CD8-0CDF	Motherboard resources
0D00-FFFF	PCI Express Root Complex
E000-EFFF	AMD Radeon(TM) Vega 11 Graphics
E000-EFFF	PCI Express Root Port
F000-FFFF	PCI Express Downstream Switch Port
F000-FFFF	PCI Express Root Port
F000-FFFF	PCI Express Upstream Switch Port

D.2 DMA Channel Assignments

Table D.2: DMA Channel Assignments

Channel	Function
4	Direct Memory Access Controller

D.3 Interrupt Assignments

Table D.3: Interrupt Assignments

Interrupt#	Interrupt Source
IRQ 0	High precision event timer
IRQ 0	System timer
IRQ 3	Communications Port (COM2)
IRQ 4	Communications Port (COM1)
IRQ 6	Motherboard resources
IRQ 7	AMD GPIO Controller
IRQ 8	High precision event timer
IRQ 12	Motherboard resources
IRQ 53	High Definition Audio Controller
IRQ 53	AMD Audio CoProcessor
IRQ 54	AMD High Definition Audio Controller
IRQ 55	AMD SFHKMDF I2C
IRQ 54-IRQ 204	Microsoft ACPI-Compliant System
IRQ 256-IRQ 511	Microsoft ACPI-Compliant System
IRQ 4294967263- IRQ 4294967268	Intel(R) I210 Gigabit Network Connection #3
IRQ 4294967269- IRQ 4294967284	AMD USB 3.10 eXtensible Host Controller - 1.10 (Microsoft)
IRQ 4294967285- IRQ 4294967287	AMD Radeon(TM) Vega 11 Graphics
IRQ 4294967288- IRQ 4294967289	AMD PSP 10.0 Device
IRQ 4294967290	Standard SATA AHCI Controller
IRQ 4294967291	PCI Express Downstream Switch Port
IRQ 294967292- IRQ 4294967294	PCI Express Root Port

D.4 1st MB Memory Map

Table D.4: 1st MB Memory Map

Addr. Range (Hex)	Device
0xA0000-0xBFFFFF	PCIExpress Root Complex
0xC0000-0xDFFFFF	PCIExpress Root Complex
0xE0000000-0xF01FFFFFFF	PCI Express Root Port
0xE0000000-0xF01FFFFFFF	PCI Express Root Complex
0xE0000000-0xF01FFFFFFF	AMD Radeon(TM) Vega 11 Graphics
0xF0000000-0xF01FFFFFFF	AMD Radeon(TM) Vega 11 Graphics
0xF8000000-0xFBFFFFFFF	System board
0xFD100000-0xFDFFFFFFFF	Motherboard resources
0xFE100000-0xFE5FFFFFFF	PCI Express Root Port
0xFE100000-0xFE5FFFFFFF	AMD SFH KMDF I2C
0xFE200000-0xFE2FFFFFFF	AMD USB 3.10 eXtensible Host Controller - 1.10 (Microsoft)
0xFE300000-0xFE3FFFFFFF	AMD USB 3.10 eXtensible Host Controller - 1.10 (Microsoft)
0xFE400000-0xFE4FFFFFFF	AMD PSP 10.0 Device
0xFE500000-0xFE57FFFFF	AMD Radeon(TM) Vega 11 Graphics
0xFE580000-0xFE5BFFFFF	AMD Audio CoProcessor
0xFE5C0000-0xFE5C7FFF	AMD High Definition Audio Controller
0xFE5C8000-0xFE5CBFFF	High Definition Audio Controller
0xFE5CC000-0xFE5CDFFF	AMD SFH KMDF I2C
0xFE5CE000-0xFE5CFFFFF	AMD PSP 10.0 Device
0xFE600000-0xFE8FFFFFFF	PCI Express Downstream Switch Port
0xFE600000-0xFE8FFFFFFF	PCI Express Root Port
0xFE600000-0xFE8FFFFFFF	PCI Express Upstream Switch Port
0xFE700000-0xFE7FFFFFFF	Intel(R) I210 Gigabit Network Connection #3
0xFE800000-0xFE803FFF	Intel(R) I210 Gigabit Network Connection #3
0xFE900000-0xFE903FFF	PCI Express Upstream Switch Port
0xFEAA0000-0xFEAFFFFFF	PCI Express Root Port
0xFEAA0000-0xFEAFFFFFF	Standard SATA AHCI Controller
0xFEB80000-0xFEBFFFFFFF	Motherboard resources
0xFEC00000-0xFEC00FFF	Motherboard resources
0xFEC01000-0xFEC01FFF	Motherboard resources
0xFEC10000-0xFEC10FFF	Motherboard resources
0xFED00000-0xFED003FF	High precision event timer
0xFED40000-0xFED44FFF	Trusted Platform Module 2.0
0xFED80000-0xFED8FFFFF	Motherboard resources
0xFED81500-0xFED818FF	AMD GPIO Controller
0xFEDC0000-0xFEDC0FFF	Motherboard resources
0xFEE00000-0xFFFFFFFF	PCI Express Root Complex
0xFEE00000-0xFFFFFFFF	Motherboard resources
0xFF000000-0xFFFFFFFF	Motherboard resources

ADVANTECH

Enabling an Intelligent Planet

www.advantech.com

Please verify specifications before quoting. This guide is intended for reference purposes only.

All product specifications are subject to change without notice.

No part of this publication may be reproduced in any form or by any means, electronic, photocopying, recording or otherwise, without prior written permission of the publisher.

All brand and product names are trademarks or registered trademarks of their respective companies.

© Advantech Co., Ltd. 2019

Our company network supports you worldwide with offices in Germany, Austria, Switzerland, the UK and the USA. For more information please contact:

Headquarters

Germany



FORTEC Elektronik AG

Augsburger Str. 2b
82110 Germering

Phone: +49 89 894450-0
E-Mail: info@forteca.de
Internet: www.forteca.de

Fortec Group Members

Austria



Distec GmbH Office Vienna

Nuschinggasse 12
1230 Wien

Phone: +43 1 8673492-0
E-Mail: info@distec.de
Internet: www.distec.de

Germany



Distec GmbH

Augsburger Str. 2b
82110 Germering

Phone: +49 89 894363-0
E-Mail: info@distec.de
Internet: www.distec.de

Switzerland



ALTRAC AG

Bahnhofstraße 3
5436 Würenlos

Phone: +41 44 7446111
E-Mail: info@altrac.ch
Internet: www.altrac.ch

United Kingdom



Display Technology Ltd.

Osprey House, 1 Osprey Court
Hichingbrooke Business Park
Huntingdon, Cambridgeshire, PE29 6FN

Phone: +44 1480 411600
E-Mail: info@displaytechnology.co.uk
Internet: www.displaytechnology.co.uk

USA



Apollo Display Technologies, Corp.

87 Raynor Avenue,
Unit 1 Ronkonkoma,
NY 11779

Phone: +1 631 5804360
E-Mail: info@apolloDisplays.com
Internet: www.apolloDisplays.com