



OUR GLOBAL
COMPETENCE
CENTRES

 APOLLO DISPLAY
TECHNOLOGIES



 DISTEC



 DISPLAY
TECHNOLOGY



Manual

ADVANTECH

AIMB-788

**Industrial ATX Motherboard for Intel® 12th generation Core™ i9/i7/i5/i3 & Pentium®/Celeron®
processor with Q670E chipset**

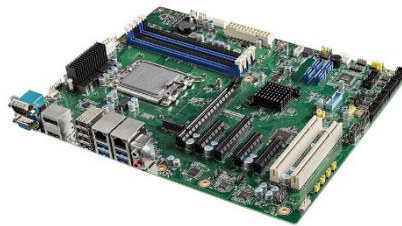

The information contained in this document has been carefully researched and is, to the best of our knowledge, accurate. However, we assume no liability for any product failures or damages, immediate or consequential, resulting from the use of the information provided herein. Our products are not intended for use in systems in which failures of product could result in personal injury. All trademarks mentioned herein are property of their respective owners. All specifications are subject to change without notice.

AIMB-788 LGA1700 12th Generation Intel® Core™ i9/i7/i5/i3 ATX Motherboard with DP/HDMI/VGA, DDR4, USB 3.2, M.2

Startup Manual

Packing List

Before you begin installing your card, please make sure that the following items have been shipped:

- 1 x AIMB-788 motherboard
- 1 x AIMB-788 startup manual
- 2 x Serial ATA HDD data cables
- 1 x I/O port bracket

If any of these items are missing or damaged, please contact your distributor or sales representative immediately.

Specifications

Standard Functions

- **CPU:** LGA1700 socket supporting 12th generation Intel® Core™ i9/i7/i5/i3/Pentium/Celeron processor.
- **BIOS:** AMI 256 Mbit SPI BIOS.
- **Chipset:** Intel® Q670E PCH.

Note: Legacy platforms are not supported.

- **System memory:** Up to 128 GB in four 288-pin DIMM sockets supporting dual-channel DDR4 3200 SDRAM. AIMB-788 supports non-ECC unbuffered DIMMs and does not support any memory configuration that mixes non-ECC with ECC unbuffered DIMMs.

For more information on this and other Advantech products, please visit our website at:

<http://www.advantech.com>



For technical support and service, please visit our support website for AIMB-788 at:

<http://advt.ch/aimb788spt>



Register your products on our website and get 2 months extra warranty for Free at:

<http://www.register.advantech.com>



This manual is for the AIMB-788 series Rev. A1, and all specifications are subject to the data-sheet on the official website. The information in this manual is subject to change without notice.

Part No. 2041078800
Printed in China

1st Edition
May 2022

Specifications (Cont.)

- **M.2 socket:** One M.2 socket supports up to PCIe x4 Gen 3 M-key 2280 type storage devices.
- **SATA interface:** Four on-board Serial ATA 3.0 connectors support data transmission rates up to 600 MB/s. All four SATA 3.0 ports support Advanced Host Controller Interface (AHCI) technology.
- **PCIe and PCI slot:** 1 PCIe x16 Gen 4 expansion slot, 1 PCIe x8 expansion slot (x4 Gen 3 link), 3 PCIe x4 Gen 3 expansion slots, 2 PCI slots 32-bit/33 MHz PCI 2.2 compliant.
- **USB 3.2/2.0:** 2 USB 3.2 Gen 2 ports on rear with up to 10 Gb/s data rate, 4 USB 3.2 Gen 1 ports (2 rear, 2 via header), 8 USB 2.0 ports (4 rear, 2 via header, 2 internal Type-A).
- **Serial port:** Six serial ports: COM1, COM2 and COM4 ~ 6 are RS-232; COM3 is RS-232/422/485 with jumper and BIOS menu options.
- **SPI interface:** Advantech-designed SPI connector supports optional TPM 2.0 module.
- **Watchdog timer:** 255 sec timer level intervals.

Graphic Interface

- **Chipset:** CPU integrated graphics controller.
- **Display memory:** 1 GB maximum shared memory with 2 GB and above system memory installed.
- **DisplayPort:** Resolution up to 4096 x 2304 @ 60 Hz refresh rate.
- **HDMI:** Resolution up to 3840 x 2160 @ 30 Hz refresh rate.
- **VGA:** Resolution up to 1920 x 1200 @ 60 Hz refresh rate.

Ethernet Interface

- **Interface:** 10/100/1000 Mbps.
- **Controller:** LAN1: Intel® I219-LM; LAN2: Intel® I210-AT.

Mechanical and Environmental

- **Dimensions (L x W):** 304.8 x 244 mm (12" x 9.6")
- **Power consumption:**
Intel Core i 65W; DDR4 32 GB x 4
Maximum: +3.3 V at 1.41 A, +5 V at 2.42 A, +12 V at 9.3 A, +5 Vsb at 0.13 A, -12 V at 0.04 A, -5 V at 0.05 A
- **Operating temperature:** 0 ~ 60° C (depending on CPU loading and thermal solution)
- **Weight of board:** 0.7 kg (1.54 lb)

Jumpers and Connectors

The board has a number of jumpers that allow you to configure your system to suit your application. The table below lists the function of each jumper and connector.

Connector / Jumper List	
Label	Function
LAN1 ~ LAN2	GbE LAN
USB3C1	USB 3.2 Gen 2 port *2
USB3C2	USB 3.2 Gen 1 port *2
USB3H1	USB 3.2 Gen 1 port *2 (20-pin header)
USB2C1	USB 2.0 port *4
USB2A1 ~ USB2A2	USB 2.0 port (internal Type-A)
USB2H2	USB 2.0 port *2 (10-pin header)
COM1+VGA1	Serial port: RS-232 (DB-9 connector) / VGA connector
DP1+HDMI1	DP connector / HDMI connector
COM2, COM4 ~ COM6	Serial port: RS-232 (9-pin header)
COM3	Serial port: RS-232/422/485 (9-pin header)
CPUFAN1	CPU fan connector (4-pin)
SYSFAN1 ~ SYSFAN3	System fan connector (4-pin)
JFP3	Power LED Suspend: fast flash (ATX/AT) System on: on (ATX/AT) System off: off (ATX/AT)
JFP2	External speaker / HDD LED connector / SMBus connector
JFP1	Power switch / reset connector
AUDIO1+AUDIO2	Audio connector (Line Out, Mic In)
VOLT1	Alarm board power connector
JCASE1	Case open connector
LANLED1	Front panel LAN indicator connector
NVME1	M.2 2280 M-key socket
SATA4 ~ SATA7	Serial ATA 3.0 port
PCI1 ~ PCI2	PCI slot
PCIE1	PCIe x16 slot (x16 Gen 4 link)
PCIE2 , PCIE4, PCIE5	PCIe x4 slot (x4 Gen 3 link)
PCIE3	PCIe x8 slot (x4 Gen 3 link)
DIMMA1	Channel A DIMM1
DIMMA2	Channel A DIMM2

Jumpers and Connectors (Cont.)

DIMMB1	Channel B DIMM1
DIMMB2	Channel B DIMM2
ATX12V1+ ATX12V2	ATX 12 V auxiliary power connector (for CPU)
EATXPWR1	ATX 24-pin main power connector (for system)
SPDIF_OUT1	SPDIF audio out pin header
GPIO1	8 bit GPIO from super I/O
SMBUS1	SMBus connector from PCH
FPAUD1	Front panel audio connector
SPI_TPM1	SPI(Serial Peripheral Interface) connector

Note

Due to Intel design specification, the PCIe1 slot can only support graphic cards and storage cards (1x8 bifurcated PCIe 5.0, 1x4 PCIe 4.0). Other types of add-on cards will have no function installed on this slot.

JCMOS1: CMOS clear data JME1: Intel ME update

Closed Pins	Result
1-2	*Keep CMOS data *Enable ME update
2-3	Clear CMOS data Disable ME update
* Default	



*Keep CMOS data
*Enable ME update



Clear CMOS data
Disable ME update

JWD1+JOB1: Watchdog timer output and OBS alarm

Closed Pins	Result
2-4, 8-10	Watchdog timer disable (2-4) OBS beep (8-10)
4-6, 8-10	*Watchdog timer reset (4-6) OBS beep (8-10)
* Default	

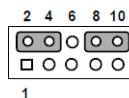

Watchdog timer disable (2-4)
OBS beep (8-10)

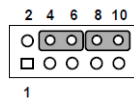

*Watchdog timer reset (4-6)
OBS beep (8-10)

Jumpers and Connectors (Cont.)

PSOEN1: ATX/AT mode selection

Closed Pins	Result
1-2	AT mode
2-3	*ATX mode
* Default	



JUSB_2 (onboard USB): USB power source switch between +5V and +5V_DUAL

Closed Pins	Result
1-2	*USB +5V_DUAL power
2-3	USB +5V power
* Default	

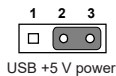

JPCICLK1: PCI clock selection

Closed Pins	Result
1-2	66 MHz
2-3	*33 MHz
* Default	



SMB1 (clock), SMB2 (data): PCIe SMBus connection setting for PCIE2~PCIE5 slots SMB3 (clock), SMB4 (data): PCIe SMBus connection setting for PCIE1 slot

Closed Pins	Result
1-2	*Enable PCIe SMBus connection
2-3	Disable PCIe SMBus connection
* Default	



*Enable PCIe SMBus connection Disable PCIe SMBus connection

Note! SMB1+SMB2 or SMB3+SMB4 jumpers should be switched to the same setting, either 1-2 closed or 2-3 closed.

Jumpers and Connectors (Cont.)

JSETCOM3: COM3 RS-232/422/485 jumper setting

Closed Pins	Result
5-6, 7-9, 8-10, 13-15, 14-16	*RS-232
3-4, 9-11, 10-12, 15-17, 16-18	RS-422
1-2, 9-11, 10-12, 15-17, 16-18	RS-485
* Default	

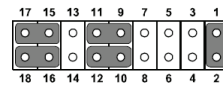
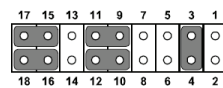
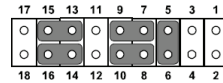

Note!

BIOS setting change is necessary if RS-422 or RS-485 is selected. Please refer to Chapter 3 of user manual for further setting.

JT1(TX signal), JR1(RX signal): COM3 RS-422/485 termination resistor

Closed Pins	Result
1-2	Disable termination
2-3	*Enable termination
* Default	



Disable termination

*Enable termination

JFV1: VGA dummy load setting

Closed Pins	Result
1-2	Enable VGA dummy load
2-3	*Disable VGA dummy load
* Default	



Enable VGA dummy load *Disable VGA dummy load

Note! It is recommended to leave this function disabled if you use DVI/DP as your main display.

Declaration of Conformity

Caution! The computer is supplied with a battery-powered realtime clock circuit. There is a danger of explosion if battery is incorrectly replaced. Replace only with same or equivalent type recommended by the manufacturer. Discard used batteries according to manufacturer's instructions.



This device complies with the requirements in Part 15 of the FCC rules. Operation is subject to the following two conditions:

1. This device may not cause harmful interference.
2. This device must accept any interference received, including interference that may cause undesired operation.

Board Layout

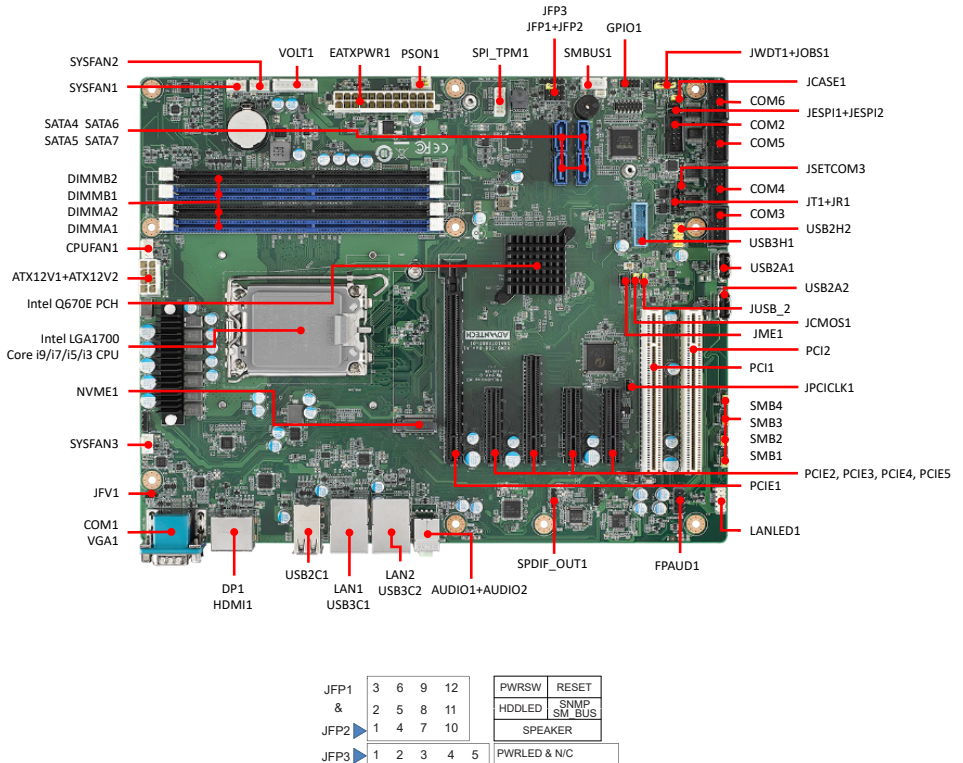

Figure 1: Board Layout: Jumper and Connector Locations

Our company network supports you worldwide with offices in Germany, Austria, Switzerland, the UK and the USA. For more information please contact:

Headquarters

Germany



FORTEC Elektronik AG

Augsburger Str. 2b
82110 Germering

Phone: +49 89 894450-0
E-Mail: info@fortecaq.de
Internet: www.fortecaq.de

Fortec Group Members

Austria



Distec GmbH Office Vienna

Nuschinggasse 12
1230 Wien

Phone: +43 1 8673492-0
E-Mail: info@distec.de
Internet: www.distec.de

Germany



Distec GmbH

Augsburger Str. 2b
82110 Germering

Phone: +49 89 894363-0
E-Mail: info@distec.de
Internet: www.distec.de

Switzerland



ALTRAC AG

Bahnhofstraße 3
5436 Würenlos

Phone: +41 44 7446111
E-Mail: info@altrac.ch
Internet: www.altrac.ch

United Kingdom



Display Technology Ltd.

Osprey House, 1 Osprey Court
Hinchingsbrooke Business Park
Huntingdon, Cambridgeshire, PE29 6FN

Phone: +44 1480 411600
E-Mail: info@displaytechnology.co.uk
Internet: www.displaytechnology.co.uk

USA



Apollo Display Technologies, Corp.

87 Raynor Avenue, Unit 1
Ronkonkoma, NY 11779

Phone: +1 631 5804360
E-Mail: info@apolloDisplays.com
Internet: www.apolloDisplays.com