



OUR GLOBAL  
COMPETENCE  
CENTRES

 APOLLO DISPLAY  
TECHNOLOGIES



 DISTEC



 DISPLAY  
TECHNOLOGY



# Manual

## iBase

### MB997

Industrial ATX Motherboard for  
9th Gen. Intel® LGA1151 Xeon® E or Core™ i Processor and  
Intel® C246, Q370 or H310 Chipset

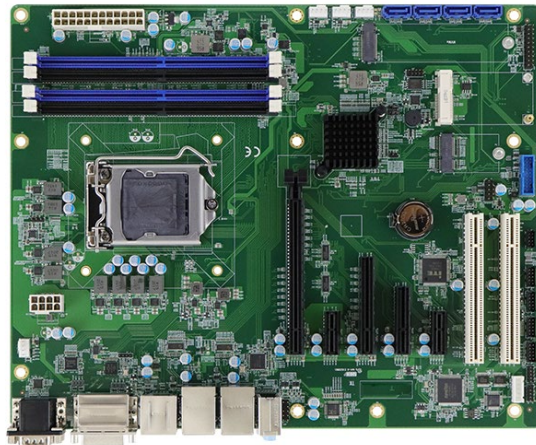

---

The information contained in this document has been carefully researched and is, to the best of our knowledge, accurate. However, we assume no liability for any product failures or damages, immediate or consequential, resulting from the use of the information provided herein. Our products are not intended for use in systems in which failures of product could result in personal injury. All trademarks mentioned herein are property of their respective owners. All specifications are subject to change without notice.

---

# **MB997**

**Intel® 9th Gen. Xeon®-E /  
Core™ DT Processor Based  
ATX Motherboard**

## **User's Manual**

Version 1.0  
(November 2020)

**Copyright**

© 2020 IBASE Technology, Inc. All rights reserved.

No part of this publication may be reproduced, copied, stored in a retrieval system, translated into any language or transmitted in any form or by any means, electronic, mechanical, photocopying, or otherwise, without the prior written consent of IBASE Technology, Inc. (hereinafter referred to as "IBASE").

**Disclaimer**

IBASE reserves the right to make changes and improvements to the products described in this document without prior notice. Every effort has been made to ensure the information in the document is correct; however, IBASE does not guarantee this document is error-free.

IBASE assumes no liability for incidental or consequential damages arising from misapplication or inability to use the product or the information contained herein, nor for any infringements of rights of third parties, which may result from its use.

**Trademarks**

All the trademarks, registrations and brands mentioned herein are used for identification purposes only and may be trademarks and/or registered trademarks of their respective owners.

## Compliance



In a domestic environment, this product may cause radio interference in which case users may be required to take adequate measures.



This product has been tested and found to comply with the limits for a Class B device, pursuant to Part 15 of the FCC Rules. These limits are designed to provide reasonable protection against harmful interference in a residential installation. This equipment generates, uses and can radiate radio frequency energy and, if not installed and used in accordance with manufacturer's instructions, may cause harmful interference to radio communications.

## WEEE



This product must not be disposed of as normal household waste, in accordance with the EU directive of for waste electrical and electronic equipment (WEEE - 2012/19/EU). Instead, it should be disposed of by returning it to a municipal recycling collection point. Check local regulations for disposal of electronic products.

## Green IBASE



This product is compliant with the current RoHS restrictions and prohibits use of the following substances in concentrations exceeding 0.1% by weight (1000 ppm) except for cadmium, limited to 0.01% by weight (100 ppm).

- Lead (Pb)
- Mercury (Hg)
- Cadmium (Cd)
- Hexavalent chromium (Cr6+)
- Polybrominated biphenyls (PBB)
- Polybrominated diphenyl ether (PBDE)

## Important Safety Information

Carefully read the precautions before using the board.

### Environmental conditions:

- Use this product in environments with ambient temperatures between 0°C and 60°C.
- Do not leave this product in an environment where the storage temperature may be below -20° C or above 80° C. To prevent from damages, the product must be used in a controlled environment.

### Care for your iBASE products:

- Before cleaning the PCB, unplug all cables and remove the battery.
- Clean the PCB with a circuit board cleaner, degreaser, or use cotton swabs and alcohol.
- Vacuum the dust with a computer vacuum cleaner to prevent the fan from being clogged.



### WARNING

### Attention during use:

- Do not use this product near water.
- Do not spill water or any other liquids on this product.
- Do not place heavy objects on the top of this product.

### Anti-static precautions

- Wear an anti-static wrist strap to avoid electrostatic discharge.
- Place the PCB on an anti-static kit or mat.
- Hold the edges of PCB when handling.
- Touch the edges of non-metallic components of the product instead of the surface of the PCB.
- Ground yourself by touching a grounded conductor or a grounded bit of metal frequently to discharge any static.



### CAUTION

Replace only with the same or equivalent type recommended by the manufacturer. Dispose of used batteries according to the manufacturer's instructions or recycle them at a local recycling facility or battery collection point.

## Warranty Policy

- **IBASE standard products:**

24-month (2-year) warranty from the date of shipment. If the date of shipment cannot be ascertained, the product serial numbers can be used to determine the approximate shipping date.

- **3<sup>rd</sup>-party parts:**

12-month (1-year) warranty from delivery for the 3<sup>rd</sup>-party parts that are not manufactured by IBASE, such as CPU, CPU cooler, memory, storage devices, power adapter, panel and touchscreen.

- \* PRODUCTS, HOWEVER, THAT FAIL DUE TO MISUSE, ACCIDENT, IMPROPER INSTALLATION OR UNAUTHORIZED REPAIR SHALL BE TREATED AS OUT OF WARRANTY AND CUSTOMERS SHALL BE BILLED FOR REPAIR AND SHIPPING CHARGES.

## Technical Support & Services

1. Visit the IBASE website at [www.ibase.com.tw](http://www.ibase.com.tw) to find the latest information about the product.
2. If you need any further assistance from your distributor or sales representative concerning problems that you may have encountered, please prepare the following information:
  - Product model name
  - Product serial number
  - Detailed description of the problem
  - The error messages in text or in screenshots if there is any
  - The arrangement of the peripherals
  - Software in use (such as OS and application software, including the version numbers)
3. If repair service is required, you can download the RMA form at <http://www.ibase.com.tw/english/Supports/RMAService/>. Fill out the form and contact your distributor or sales representative.

# Table of Contents

---

<b>Chapter 1</b>	<b>General Information .....</b>	<b>1</b>
1.1	Introduction .....	2
1.2	Features .....	2
1.3	Packing List .....	3
1.4	Optional Accessories .....	3
1.5	Specifications .....	4
1.6	Block Diagram .....	6
1.7	Product View .....	7
1.8	Dimensions .....	9
<b>Chapter 2</b>	<b>Hardware Configuration .....</b>	<b>11</b>
2.1	Installations .....	12
2.1.1	Installing the Memory .....	12
2.2	Setting the Jumpers .....	13
2.3	Jumper & Connector Locations on MB997 .....	14
2.4	Jumpers Quick Reference .....	15
2.4.1	Clear CMOS Data (JP7) .....	15
2.4.2	Clear RTC (JP6) .....	16
2.4.3	Flash Descriptor Security Override (JP5) .....	17
2.5	Connectors Quick Reference .....	18
2.5.1	CN1: COM1 & COM2 Ports .....	19
2.5.2	J3: Digital I/O Connector .....	20
2.5.3	ATX_12V_2X1: ATX 12V Power Connector .....	21
2.5.4	CN7: SATA3 #2 Connector .....	22
2.5.5	CN8: SATA3 #0 Connector .....	23
2.5.6	CN9: SATA3 #3 Connector .....	24
2.5.7	CN10: SATA3 #1 Connector .....	25
2.5.8	CN12: HDMI Connector .....	26
2.5.9	J9, J8, J6, J5: COM3, COM4, COM5, COM6 RS232 .....	27
2.5.10	CPU_FAN1: CPU Fan Power Connector (PWM Only) .....	28
2.5.11	J10: PS2 Keyboard/Mouse .....	29
2.5.12	J13: USB2 Connector .....	30
2.5.13	J14: USB3 Connector .....	31
2.5.14	J23: Front Panel Connector .....	32
2.5.15	J25: 24-pin ATX power connector .....	33
2.5.16	SYS_FAN1, SYS_FAN2, SYS_FAN3: System Fan Power Connector (PWM Only) .....	34



<b>Chapter 3</b>	<b>Drivers Installation .....</b>	<b>35</b>
3.1	Introduction .....	36
3.2	Intel® Chipset Software Installation Utility .....	36
3.3	HD Graphics Driver Installation .....	38
3.4	HD Audio Driver Installation .....	39
3.5	LAN Driver Installation .....	40
3.6	Intel® Management Engine Drivers Installation .....	41
<b>Chapter 4</b>	<b>BIOS Setup.....</b>	<b>42</b>
4.1	Introduction .....	43
4.2	BIOS Setup .....	43
4.3	Main Settings .....	44
4.4	Advanced Settings .....	45
4.4.1	CPU Configuration .....	46
4.4.2	PCH-FW Configuration .....	47
4.4.3	AMT Configuration .....	48
4.4.4	Trusted Computing .....	49
4.4.5	ACPI Settings .....	50
4.4.6	NCT66860 Super IO Configuration .....	51
4.4.7	Hardware Monitor .....	52
4.4.8	iSmart Controller 4.0 (eSIO).....	53
4.4.9	F8126SEC Super IO Configuration .....	54
4.4.10	USB Configuration .....	55
4.4.11	CSM Configuration .....	57
4.4.12	NVMe Configuration .....	58
4.4.13	Network Stack Configuration.....	58
4.5	Chipset Settings.....	60
4.6	Security Settings .....	63
4.7	Boot Settings .....	65
4.8	Save & Exit Settings .....	66
<b>Appendix</b> .....	<b>67</b>	
A.	I/O Port Address Map .....	68
B.	Interrupt Request Lines (IRQ) .....	70
C.	Watchdog Timer Configuration.....	71
D.	On-Board Connector Types .....	76

This page is intentionally left blank.

# Chapter 1

## General Information

The information provided in this chapter includes:

- Features
- Packing List
- Specifications
- Block Diagram
- Product View
- Board Dimensions

## 1.1 Introduction

MB997 is an ATX motherboard that supports Intel® Xeon® E/ Core™ i7/i5/i3 processors and four DDR4 DIMM memory sockets with a capacity of up to 128GB. The board features high-performance graphics processing to create media-rich content and brilliant HD entertainment with DVI-D, HDMI (2.0a) and DisplayPort display interface. Connectivity is provided by eight USB3.1, two USB 2.0, four SATA 3.0, and six COM ports.



**Photo of MB997**

## 1.2 Features

- Supports 9th Gen Intel® Xeon® E/ Core™ i7/i5/i3 processors
- 4x DDR4 DIMM, Max.128GB
- Intel® processor integrated graphics with HDMI(2.0a), DVI-D, and DisplayPort
- Dual Intel® Gigabit LAN
- 4x USB3.1, 2x USB 2.0, 2x SATA 3.0, 6x COM
- 1x PCI-E(x16), 1x PCI-E(x8)(Gen3.0), 1x PCI-E(x4), 2x PCI-E(x1), 2x PCI
- Watchdog timer, Digital I/O, iAMT (11.6), TPM(2.0), iSMART (4.0)

## 1.3 Packing List

Your MB997 package should include the items listed below. If any of the items below is missing, contact the distributor or dealer from whom you purchased the product.

- MB997 Motherboard x 1
- I/O shield x 1
- SATA cable (SATA-3F) x 1
- COM port cable (PK1-2KA) x 1
- Disk (with chipset drivers) x 1
- This User's Manual x 1

## 1.4 Optional Accessories

IBASE provides optional accessories listed below. Please contact us or your dealer if you have any requirements.

- USB cable (USB2K-9)
- USB 3.0 cable (USB-3K)
- PS/2 keyboard & mouse cable (PS2NK)
- Mini-PCIe extension bracket

## 1.5 Specifications

<b>Product Name</b>	<b>MB997AF-C246</b>	<b>MB997AF</b>	<b>MB997EF</b>
<b>Form Factor</b>	ATX motherboard		
<b>System</b>			
<b>Operating System</b>	<ul style="list-style-type: none"> <li>• Windows 10 (64-bit)</li> <li>• Linux Fedora (64-bit) &amp; Ubuntu (64-bit)</li> <li>• Windows Server</li> </ul>		
<b>CPU</b>	Socket LGA1151 for 9th Gen Intel® Xeon® E/ Core™ i7/i5/i3 HC/QC/DC processors		
<b>Chipset</b>	Intel® C246 PCH	Intel® Q370 PCH	Intel® H310 PCH
<b>Memory*</b>	4 x DDR4-2666/2400 DIMM, Max.128GB		2 x DDR4-2666 / 2400 DIMM, Max.64GB
<b>Storage</b>	M.2 M2280 slot supporting NVMe for SSD		N/A
<b>Graphics</b>	HD graphics integrated into the processor		
<b>Network Controller</b>	1 <sup>st</sup> LAN: Intel® I219LM GbE 2 <sup>nd</sup> LAN: Intel® I210AT GbE	1 <sup>st</sup> LAN: Intel® I219LM GbE 2 <sup>nd</sup> LAN: Intel® I211AT GbE	1 <sup>st</sup> LAN: Intel® I219V GbE 2 <sup>nd</sup> LAN: Intel® I211AT GbE
<b>Super I/O</b>	Nuvoton NC T6686D-T1		
<b>Audio</b>	Intel® CNL PCH-H built-in High Definition Audio controller + Realtek audio codec ALC662-VD0-GR w/ 5.1 channels		
<b>Power Supply</b>	ATX Power, 12V		
<b>H/W Monitor</b>	Yes		
<b>Watchdog Timer</b>	Yes (256 segments, 0, 1, 2...255 sec / min)		
<b>BIOS</b>	AMI BIOS		
<b>RAID</b>	RAID 0/1/5/10		No
<b>iSMART</b>	Yes		
<b>iAMT</b>	11.6		
<b>TPM</b>	2.0		

\* ECC will be supported per CPU SKUs.

Product Name	MB997AF-C246	MB997AF	MB997EF
<b>EuP/ErP Compliance</b>	No	No	Yes
<b>RoHS</b>	Yes		
<b>Dimensions</b>	305 x 244 mm (12" x 9.61")		
<b>Certification</b>	CE (EN55032:2012), FCC Class B, LVD		
I/O Ports			
<b>Display</b>	<ul style="list-style-type: none"> <li>• 1 x HDMI 2.0a (4096 x 2160 at 60 Hz)</li> <li>• 1 x DisplayPort 1.2 (4096 x 2160 at 60 Hz)</li> <li>• 1 x DVI-D (1920 x 1600 at 60 Hz)</li> </ul>		
<b>LAN</b>	<ul style="list-style-type: none"> <li>• 2 x RJ45 GbE LAN</li> </ul>		
<b>USB</b>	<ul style="list-style-type: none"> <li>• 4x USB3.1 Gen2 (10Gpbs)</li> <li>• 2x USB3.1 Gen1 (5Gpbs) for MB997AF/ AF-C246</li> <li>• 2x USB3.1 Gen1 (5Gpbs) via box-header for MB997AF/ MB997AF-C246</li> </ul>		
<b>Serial</b>	4x RS323, 2x RS232/422/485		
<b>SATA</b>	4 x SATA 3.0		
<b>Audio Jack</b>	1 x Line-In, 1 x Line-Out, 1 x Mic-In		
<b>Digital IO</b>	4-In & 4-Out		
<b>SSD</b>	1 slot for M.2 (M2280) for MB997AF/ AF-C246		
<b>Expansion Slots</b>	<ul style="list-style-type: none"> <li>• 1x PCI-E(x16), 1x PCI-E(x8)(Gen3.0) for MB997AF/AF-C246 **While PCIe(8x) insert card, PCIe(16x) slot will be PCIe(x8) only**</li> <li>• 1x PCI-E(x4) for MB997AF/AF-C246</li> <li>• 2x PCI-E(x1), 2x PCI</li> <li>• 1x Mini PCIe x 1</li> <li>• 1x M.2(M2280) supports NVMe &amp; SATA (M-key for MB997AF/AF-C246)</li> <li>• 1x M.2(E2230) supports CNVi</li> </ul>		
Environment			
<b>Temperature</b>	<ul style="list-style-type: none"> <li>• Operating: 0 ~ 60 °C (32 ~ 140 °F)</li> <li>• Storage: -20 ~ 80 °C (-4 ~ 176 °F)</li> </ul>		
<b>Relative Humidity</b>	0 ~ 90 %, non-condensing at 60 °C		

All specifications are subject to change without prior notice.

## 1.6 Block Diagram

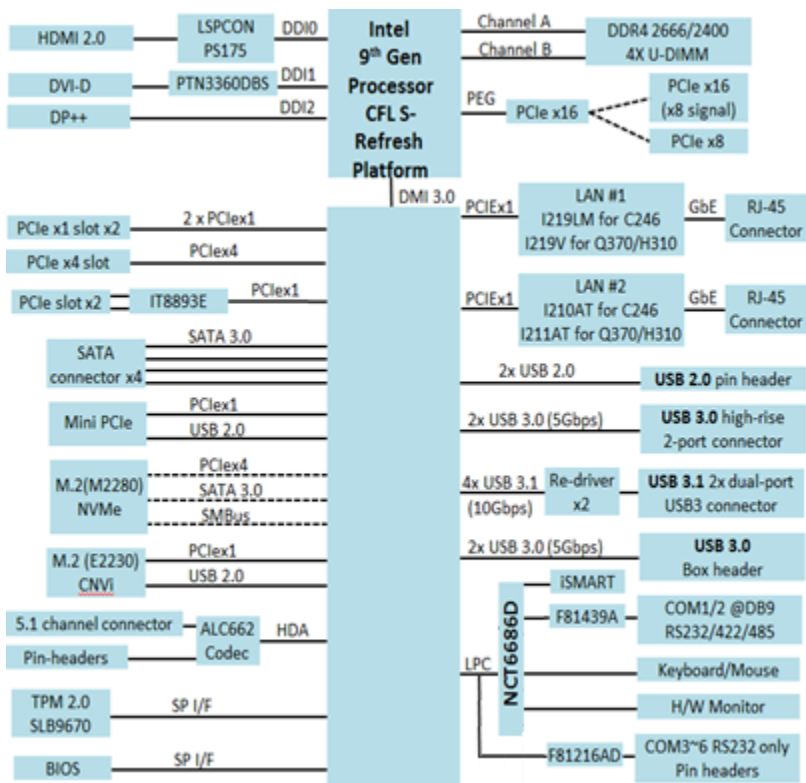



## 1.7 Product View

### Top View



### I/O View

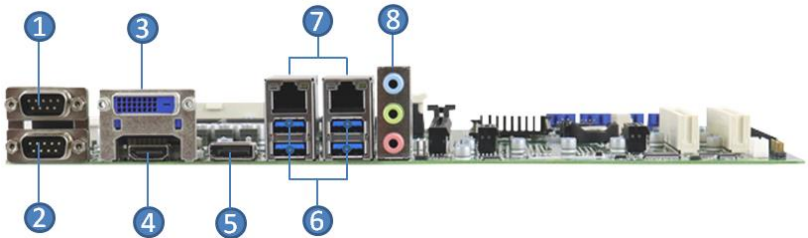

No.	Name	No.	Name
1	COM1 Port (CN1)	6	USB 3.1 Ports
2	COM2 Port (CN1)	7	GbE LAN Ports (CN3, CN4)
3	DVI-D Port (CN11)	8	Line-In (top) (CN5)
4	HDMI Port (CN12)		Audio Line-Out (middle) (CN5)
5	DisplayPort (CN2)		Microphone-In (bottom) (CN5)

**Bottom View**



\* The photos above are for reference only. Some minor components may differ.

## 1.8 Dimensions

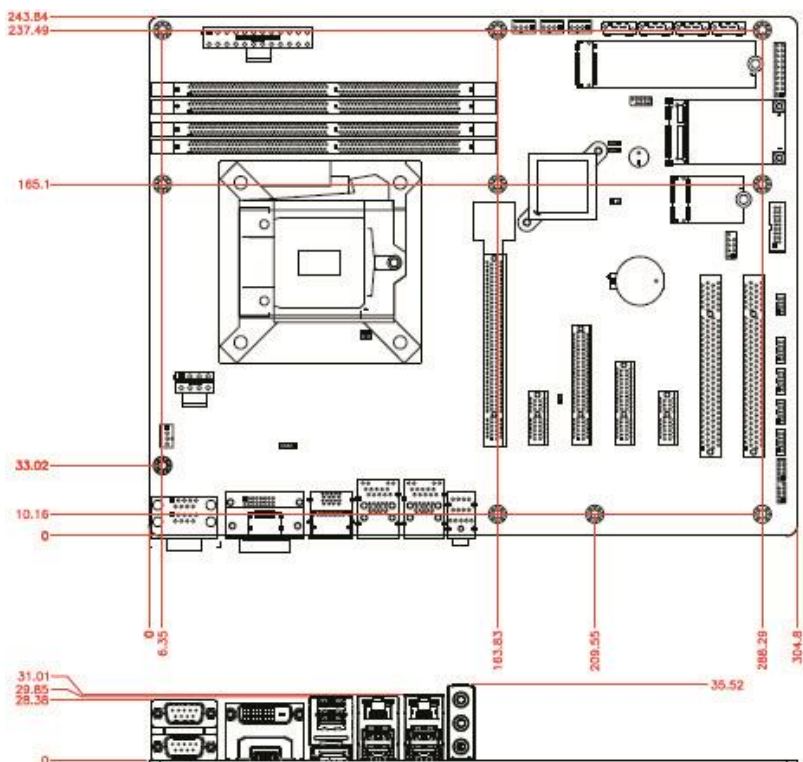

This page is intentionally left blank.

# Chapter 2

## Hardware Configuration

This section provides information on jumper settings and connectors on the board in order to set up a workable system. The topics covered are:

- Essential installations before you begin:  
CPU and the memory
- Jumper and connector locations
- Jumper settings and information of connectors

## 2.1 Installations

### 2.1.1 Installing the Memory

To install the modules, locate the memory slot on the board and perform the following steps:

1. Press the ejector tabs of the memory slot down and outwards with your fingertips.

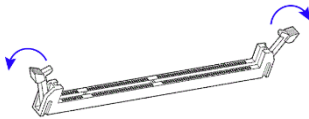

2. Hold the memory module and align the key of the module with that on the memory slot.
3. Gently push the module in an upright position until the ejector tabs of the memory slot close to hold the module in place when the module touches the bottom of the slot.

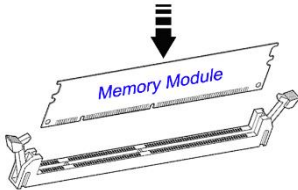

To remove the module, press the ejector tabs outwards with your fingertips to eject the module.

## 2.2 Setting the Jumpers

Set up and configure this board by using jumpers for various settings and features according to your needs and applications. Contact your supplier if you have doubts about the best configuration for your use.

### 2.2.1 How to Set Jumpers

Jumpers are short-length conductors consisting of several metal pins with a non-conductive base mounted on the circuit board. Jumper caps are used to have the functions and features enabled or disabled. If a jumper has 3 pins, you can connect either PIN1 to PIN2 or PIN2 to PIN3 by shorting.

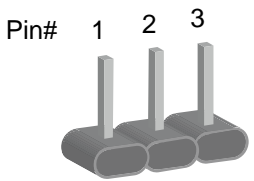

A 3-pin jumper

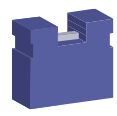

A jumper cap

Refer to the illustration below to set jumpers.

Pin closed	Oblique view	Illustration
Open		
1-2		
2-3		

When two pins of a jumper are encased in a jumper cap, this jumper is **closed**, i.e. turned **On**.

When a jumper cap is removed from two jumper pins, this jumper is **open**, i.e. turned **Off**.

## 2.3 Jumper & Connector Locations on MB997

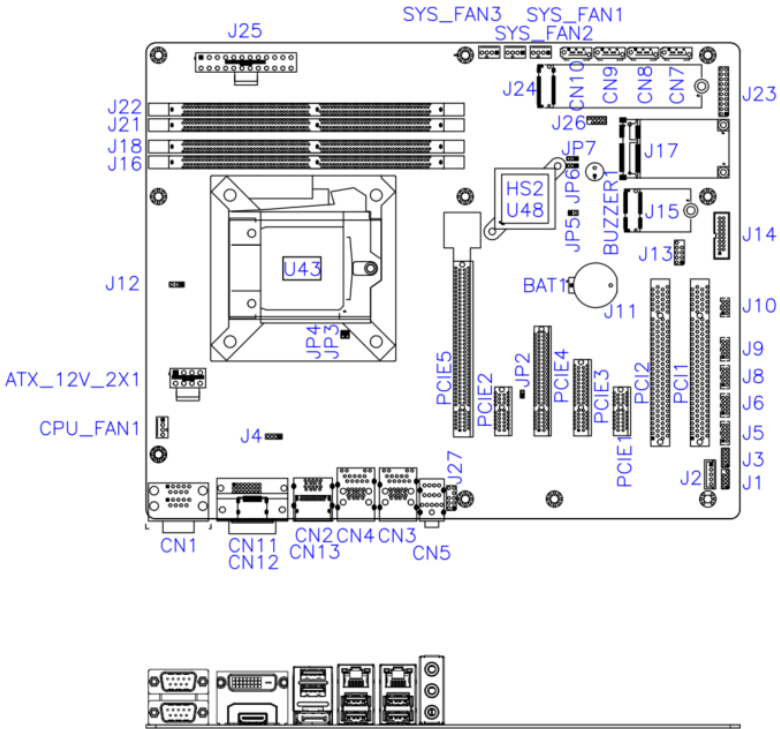



## 2.4 Jumpers Quick Reference

Function	Jumper Name	Page
Clear CMOS Data	JP7	15
Clear RTC	JP6	16
Flash Descriptor Security Override	JP5	17

### 2.4.1 Clear CMOS Data (JP7)

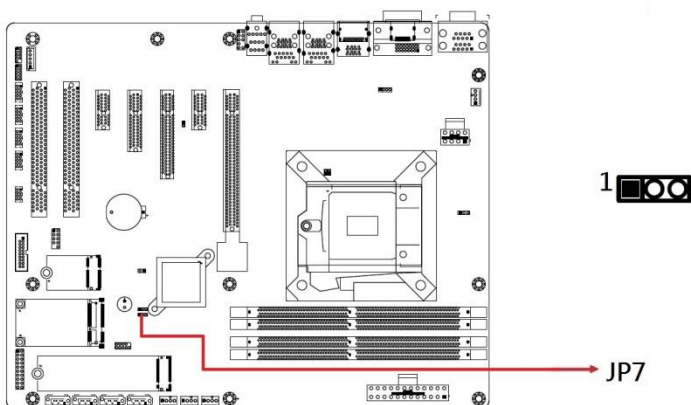

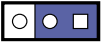
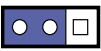
Function	Pin closed	Illustration
Normal (default)	1-2	 1
Clear CMOS	2-3	 1

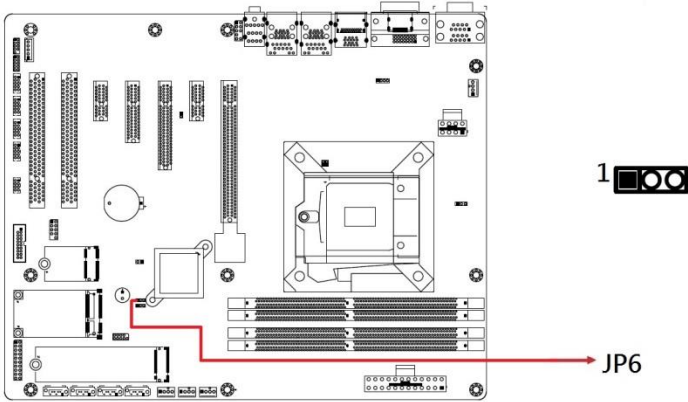

## 2.4.2 Clear RTC (JP6)

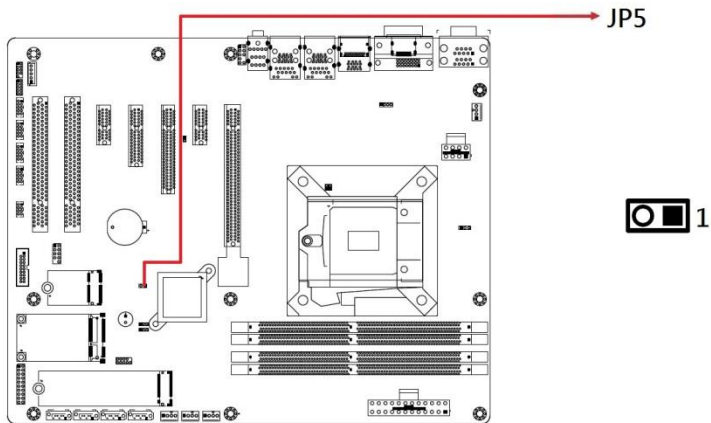

Function	Pin closed	Illustration
Normal (default)	1-2	1
Clear CMOS	2-3	1

### 2.4.3 Flash Descriptor Security Override (JP5)



Function	JP5 Pin	Illustration
Disabled (default)	Open	 1
Enabled	Close	 1

\*Factory use only.

## 2.5 Connectors Quick Reference

Function	Connector	Page
COM1 & COM2 Ports	CN1	19
Digital I/O Connector	J3	20
ATX 12V Power Connector	ATX_12V_2X1	21
SATA3 #2 Connector	CN7	22
SATA3 #0 Connector	CN8	23
SATA3 #3 Connector	CN9	24
SATA3 #1 Connector	CN10	25
HDMI Connector	CN12	26
COM3, COM4, COM5, COM6 RS232 Serial Ports	J9, J8, J6, J5	27
CPU Fan Power Connector	CPU_FAN1	28
PS2 Keyboard/Mouse	J10	29
USB2 Connector	J13	30
USB3 Connector	J14	31
Front Panel Connector	J23	32
24-pin ATX Power Connector	J25	33
System Fan Power Connectors	SYS_FAN1, SYS_FAN2, SYS_FAN3	34

### 2.5.1 CN1: COM1 & COM2 Ports

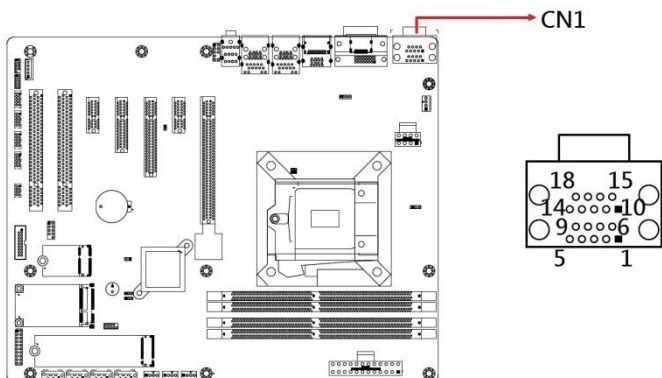

Pin	Signal Name	Pin	Signal Name
1	DCD, Data carrier detect	6	DSR, Data set ready
2	RXD, Receive data	7	RTS, Request to send
3	TXD, Transmit data	8	CTS, Clear to send
4	DTR, Data terminal ready	9	RI, Ring indicator
5	Ground		

Pin	Signal Name		
	RS-232	RS-422	RS-485
1	DCD	TX-	DATA-
2	RX	TX+	DATA+
3	TX	RX+	NC
4	DTR	RX-	NC
5	Ground	Ground	Ground
6	DSR	NC	NC
7	RTS	NC	NC
8	CTS	NC	NC
9	RI	NC	NC

## 2.5.2 J3: Digital I/O Connector

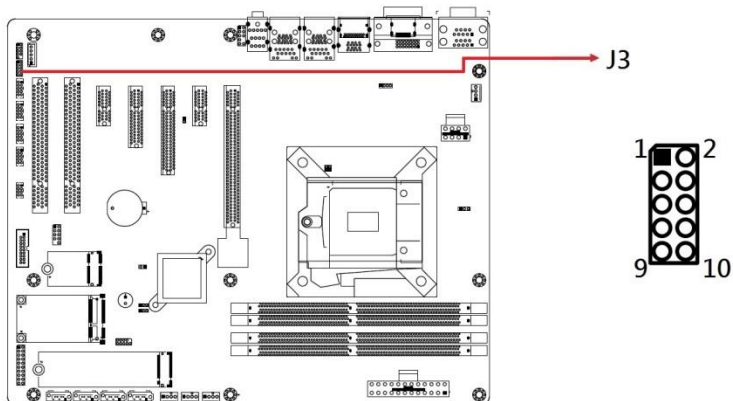

Pin	Signal Name	Pin	Signal Name
1	Ground	2	+5V
3	OUT3	4	OUT1
5	OUT2	6	OUT0
7	IN3	8	IN1
9	IN2	10	IN0

### 2.5.3 ATX\_12V\_2X1: ATX 12V Power Connector

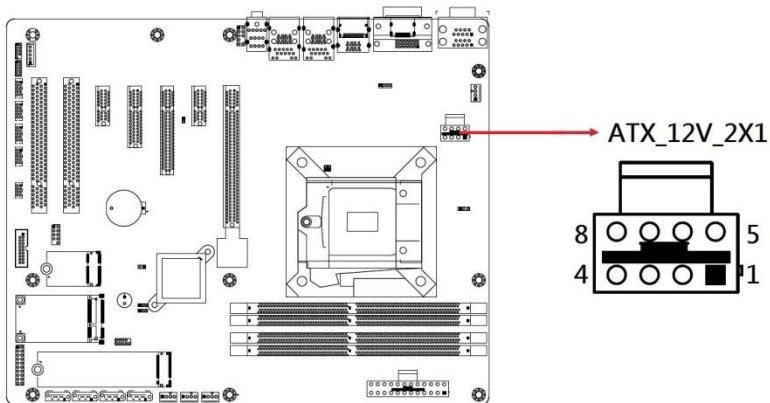

Pin	Signal Name	Pin	Signal Name
1	Ground	5	+12V
2	Ground	6	+12V
3	Ground	7	+12V
4	Ground	8	+12V

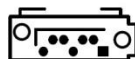
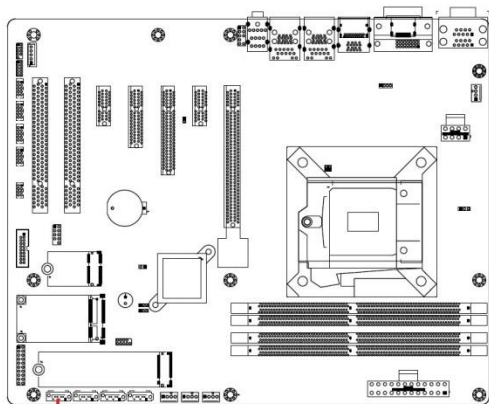
**2.5.4 CN7: SATA3 #2 Connector****CN7**

Pin	Signal Name	Pin	Signal Name
1	Ground	5	RX-
2	TX+	6	RX+
3	TX-	7	Ground
4	Ground		



## 2.5.5 CN8: SATA3 #0 Connector

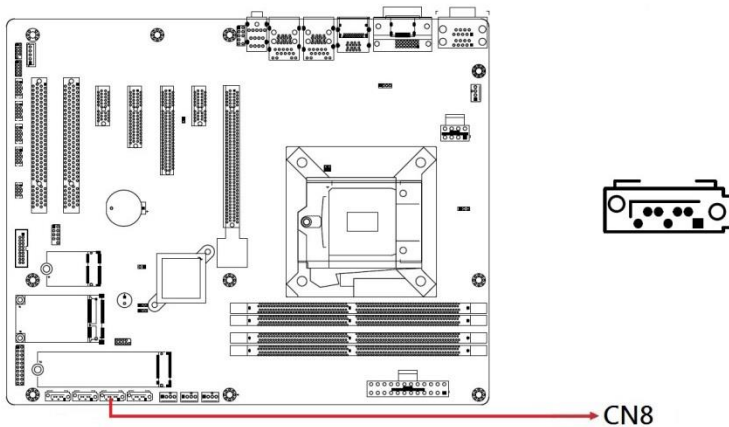

Pin	Signal Name	Pin	Signal Name
1	Ground	5	RX-
2	TX+	6	RX+
3	TX-	7	Ground
4	Ground		

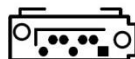
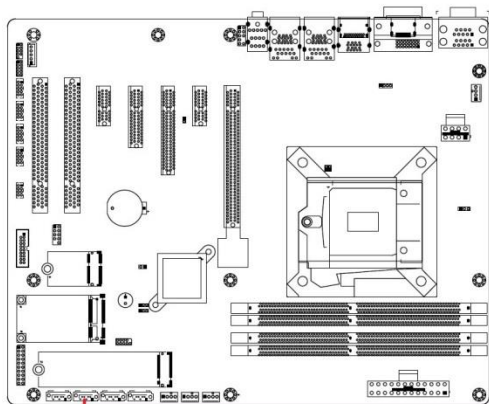
**2.5.6 CN9: SATA3 #3 Connector**

CN9

Pin	Signal Name	Pin	Signal Name
1	Ground	5	RX-
2	TX+	6	RX+
3	TX-	7	Ground
4	Ground		

## 2.5.7 CN10: SATA3 #1 Connector

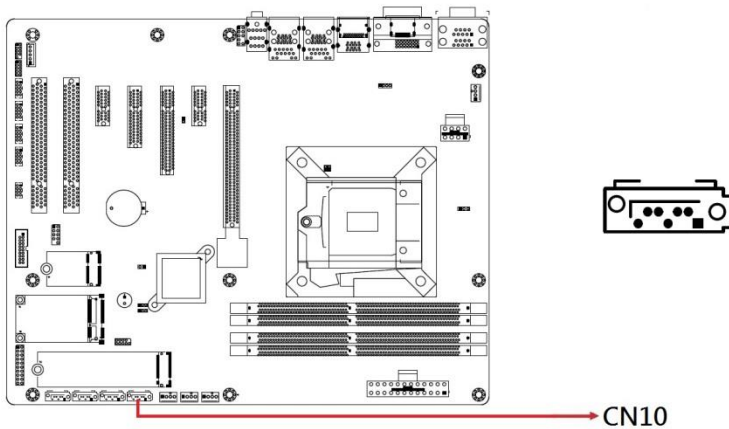

Pin	Signal Name	Pin	Signal Name
1	Ground	5	RX-
2	TX+	6	RX+
3	TX-	7	Ground
4	Ground		

## 2.5.8 CN12: HDMI Connector

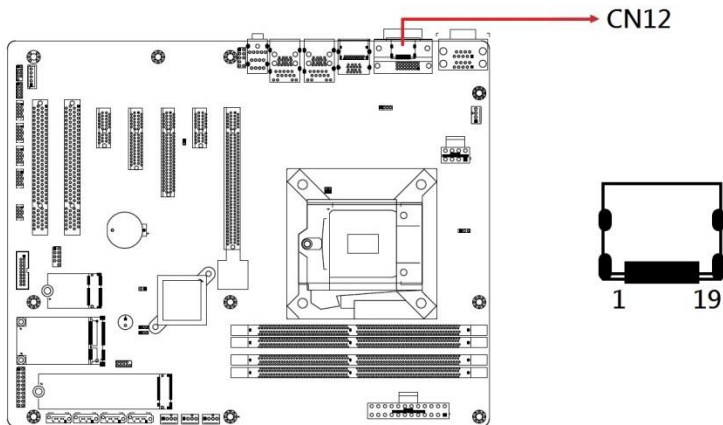

Pin	Signal Name	Pin	Signal Name
1	TMDS Data2+	11	TMDS Clock Shield
2	TMDS Data2 Shield	12	TMDS Clock-
3	TMDS Data2-	13	CEC
4	TMDS Data1+	14	Reserved
5	TMDS Data1 Shield	15	SCL
6	TMDS Data1-	16	SDA
7	TMDS Data0+	17	GND
8	TMDS Data0 Shield	18	+5V
9	TMDA Data0-	19	Hot Plug
10	TMDS Clock+		

### 2.5.9 J9, J8, J6, J5: COM3, COM4, COM5, COM6 RS232 Serial Ports (HK\_DF11-10S-PA66H)

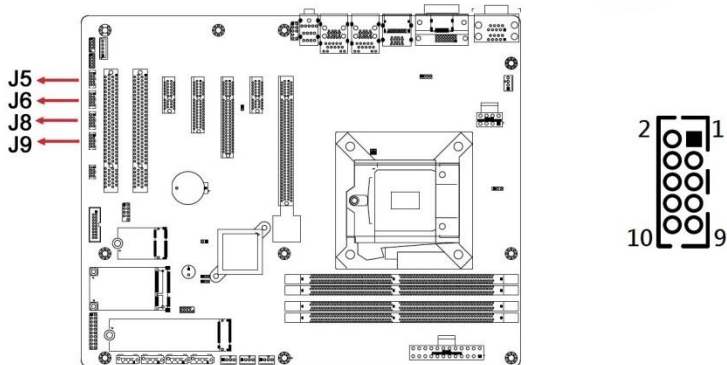

Pin	Signal Name	Pin	Signal Name
1	DCD#	2	SIN#
3	SOUT	4	RTS#
5	GND	6	DSR#
7	DTR#	8	CTS#
9	RI#	10	KEY

## 2.5.10 CPU\_FAN1: CPU Fan Power Connector (PWM Only)

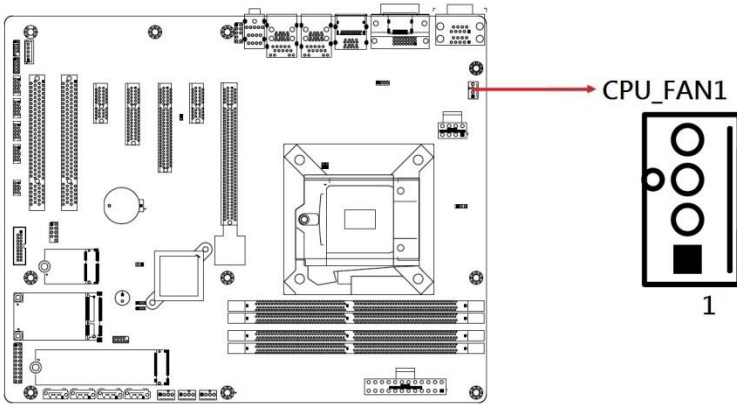

Pin	Signal Name	Pin	Signal Name
1	Ground	3	Rotation detection
2	+12V	4	Control

### 2.5.11 J10:PS2 Keyboard/Mouse (HK\_DF11-8S-PA66H)

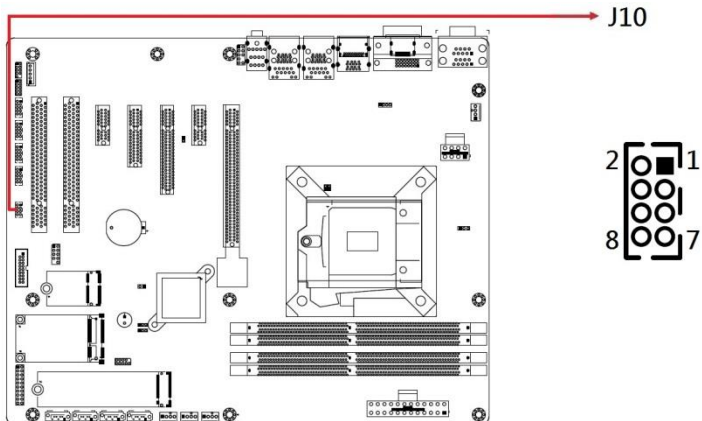

Pin	Signal Name	Pin	Signal Name
1	VCC	2	VCC
3	MDA	4	KBDA
5	MCL	6	KBCL#
7	GND	8	GND

**2.5.12 J13: USB2 Connector (E-CALL\_0126-01-2811009)**

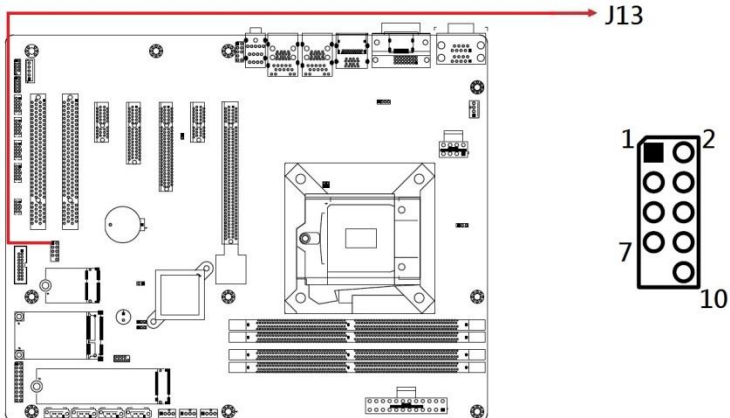

Pin	Signal Name	Pin	Signal Name
1	Vcc	2	VCC
3	D0-	4	D1-
5	D0+	6	D1+
7	Ground	8	GND
9	KEY	10	NC



### 2.5.13 J14: USB3 Connector (PINREX\_52X-40-20GU52)

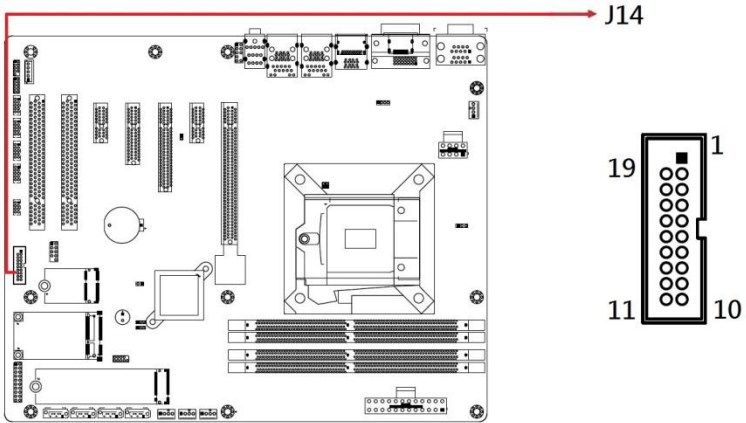

Pin	Signal Name	Pin	Signal Name
1	VCC	X	
2	P1_SSRX-	19	VCC
3	P1_SSRX+	18	P2_SSRX-
4	GND	17	P2_SSRX+
5	P1_SSTX-	16	GND
6	P1_SSTX+	15	P2_SSTX-
7	GND	14	P2_SSTX+
8	P1_U2_D-	13	GND
9	P1_U2_D+	12	P2_U2_D
10	NC	11	P2_U2_D+

## 2.5.14 J23: Front Panel Connector

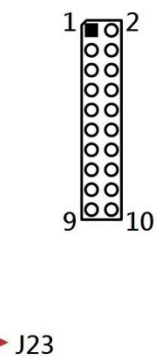
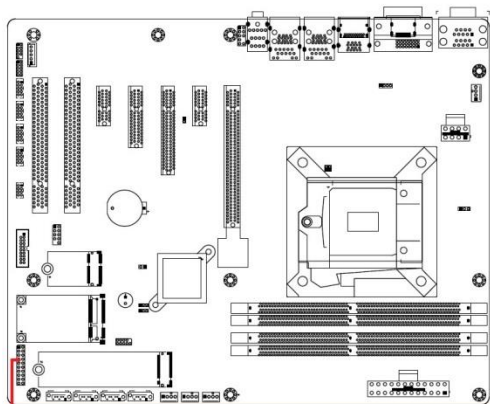

J23

Pin	Signal Name	Pin	Signal Name
1	Power LED+	2	SPK
2	GND	4	NC
3	Power LED-	6	GND
4	NC	8	SPK(VCC)
5	GND	10	NC
6	GND	12	NC
7	Power BTN	14	Power BTN
8	NC	16	NC
9	Reset BTN	18	Reset BTN
10	HDD LED+	20	HDD LED-

### 2.5.15 J25: 24-pin ATX power connector

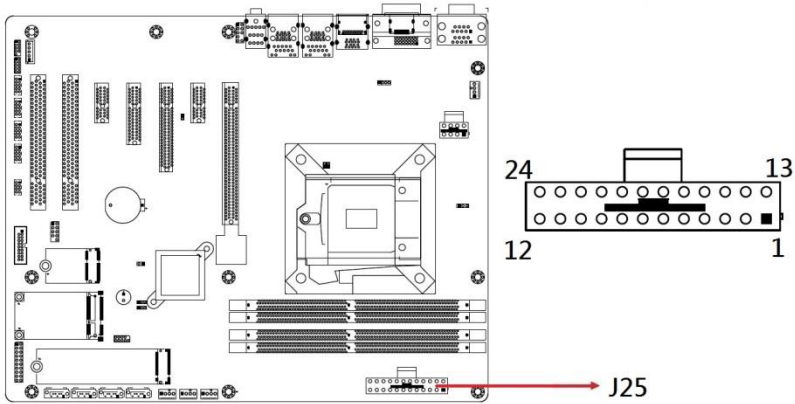

Pin	Signal Name	Pin	Signal Name
13	3.3V	1	3.3V
14	-12V	2	3.3V
15	Ground	3	Ground
16	PS-ON	4	+5V
17	Ground	5	Ground
18	Ground	6	+5V
19	Ground	7	Ground
20	-5V	8	Power good
21	+5V	9	5VSB
22	+5V	10	+12V
23	+5V	11	+12V
24	Ground	12	3.3V

**2.5.16 SYS\_FAN1, SYS\_FAN2, SYS\_FAN3: System Fan Power Connector (PWM Only)**

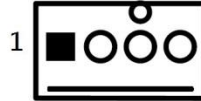
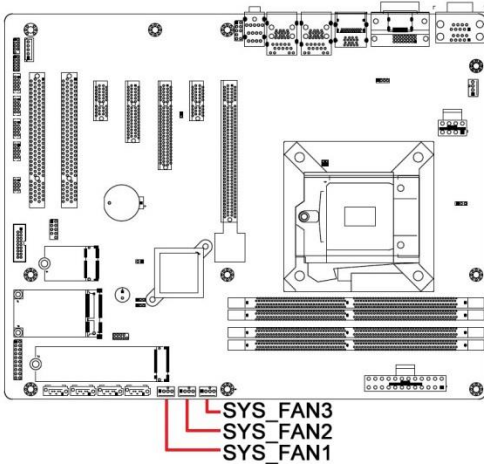

Pin	Signal Name	Pin	Signal Name
1	Ground	3	Rotation detection
2	+12V	4	Control

# Chapter 3

## Drivers Installation

This chapter introduces installation of the following drivers:

- Intel® Chipset Software Installation Utility
- HD Graphics Driver
- HD Audio Driver
- LAN Driver
- Intel® Management Engine Drivers Installation

## 3.1 Introduction

This section describes the installation procedures for software and drivers. The software and drivers are included with the motherboard. If you find anything missing, please contact the distributor where you made the purchase. The contents of this section include the following:

---

**Note:** After installing your operating system, you must install the Intel® Chipset Software Installation Utility first before proceeding with the drivers installation.

---

## 3.2 Intel® Chipset Software Installation Utility

The Intel® Chipset drivers should be installed first before the software drivers to install INF files for Plug & Play function for Intel chipset components. Follow the instructions below to complete the installation.

1. Insert the disk enclosed in the package with the board. Click **Intel** on the left pane and then **Intel(R) Coffeelake Chipset Drivers** on the right pane.



2. Click **Intel(R) Chipset Software Installation Utility**.



3. When the *Welcome* screen to the Intel® Chipset Device Software appears, click **Next** to continue.
4. Accept the software license agreement and proceed with the installation process.
5. On the *Readme File Information* screen, click **Install** for installation.
6. The driver has been completely installed. Restart the computer for changes to take effect.

## 3.3 HD Graphics Driver Installation

1. Click **Intel** on the left pane and then **Intel(R) Coffeelake Chipset Drivers** on the right pane.



2. Click **Intel(R) HD Graphics Driver**.



3. When the *Welcome* screen appears, click **Next** to continue.
4. Accept the license agreement and click **Next**.
5. On the *Readme File Information* screen, click **Next** until the installation starts.
6. After Setup is Complete, restart the computer for changes to take effect.



### 3.4 HD Audio Driver Installation

1. Click **Intel** on the left pane and then **Intel(R) Coffeelake Chipset Drivers** on the right pane.



2. Click **Realtek High Definition Audio Driver**.



3. When the *Welcome* screen appears, click **Next**. Realtek High Definition Audio Driver will then configure the new software installation.
4. When the InstallShield Wizard has completed the installation, restart the computer for changes to take effect.

### 3.5 LAN Driver Installation

1. Click **Intel** on the left pane and then **Intel(R) Coffeelake Chipset Drivers** on the right pane.



2. Click **Intel(R) PRO LAN Network Drivers**.



3. When the *Welcome* screen appears, click **Next**.
4. On the next screen, accept the license agreement and click **Next**.
5. When the *Setup Options* screen appears, select the program features you want installed and click **Next**.
6. When the *Ready to Install the Program* screen appears, click **Install**.
7. When the *Install wizard Completed* screen appears, click **Finish**.

## 3.6 Intel® Management Engine Drivers Installation

1. Click **Intel** on the left pane and then **Intel(R) Coffeelake Chipset Drivers** on the right pane.



2. On the Welcome screen, click **Next**.

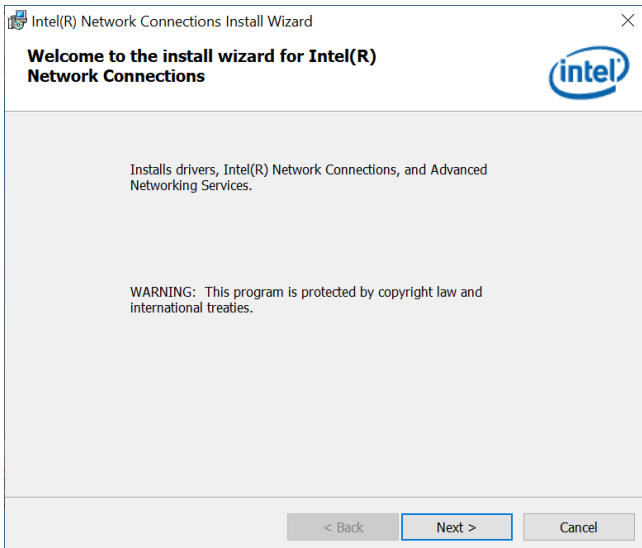

3. Accept the license agreement and click **Next**.
4. On the Destination Folder screen, click **Next**.
5. The Install Wizard is now ready to begin installation. Click **Install**.
6. When Setup has completed the installation, click **Finish**.

# Chapter 4

## BIOS Setup

This chapter describes the different settings available in the AMI BIOS that comes with the board. The topics covered in this chapter are as follows:

- Main Settings
- Advanced Settings
- Chipset Settings
- Boot Settings
- Security Settings
- Save & Exit

## 4.1 Introduction

The BIOS (Basic Input/Output System) installed in the ROM of your computer system supports Intel® processors. The BIOS provides critical low-level support for standard devices such as disk drives, serial ports and parallel ports. It also provides password protection as well as special support for detailed fine-tuning of the chipset controlling the entire system.

## 4.2 BIOS Setup

The BIOS provides a Setup utility program for specifying the system configurations and settings. The BIOS ROM of the system stores the Setup utility. When you turn on the computer, the BIOS is immediately activated. Pressing the <Del> key immediately allows you to enter the Setup utility. If you are a little bit late pressing the <Del> key, POST (Power On Self Test) will continue with its test routines, thus preventing you from invoking the Setup.

If you still need to enter Setup, restart the system by pressing the "Reset" button or simultaneously pressing the <Ctrl>, <Alt> and <Delete> keys. You can also restart by turning the system Off and back On again.

The following message will appear on the screen:

```
Press <DEL> to Enter Setup
```

In general, press the arrow keys to highlight items, <Enter> to select, the <PgUp> and <PgDn> keys to change entries, <F1> for help, and <Esc> to quit.

When you enter the BIOS Setup utility, the *Main Menu* screen will appear on the screen. The Main Menu allows you to select from various setup functions and exit choices.

---

**Warning:** It is strongly recommended that you avoid making any changes to the chipset defaults.

These defaults have been carefully chosen by both AMI and your system manufacturer to provide the absolute maximum performance and reliability. Changing the defaults could make the system unstable and crash in some cases.

---

### 4.3 Main Settings



BIOS Setting	Description
System Date	Sets the date. Use the Tab to switch between the data elements.  Default Ranges: Year: 2005-2099 Months: 1-12 Days: dependent on month
System Time	Set the time. Use Tab to switch between the Time elements.

**REMARKS:** The descriptions are based on the BIOS screens from MB997AF and MB997AF-C246 motherboard models.

## 4.4 Advanced Settings

This section allows you to configure, improve your system and allows you to set up some system features according to your preference.

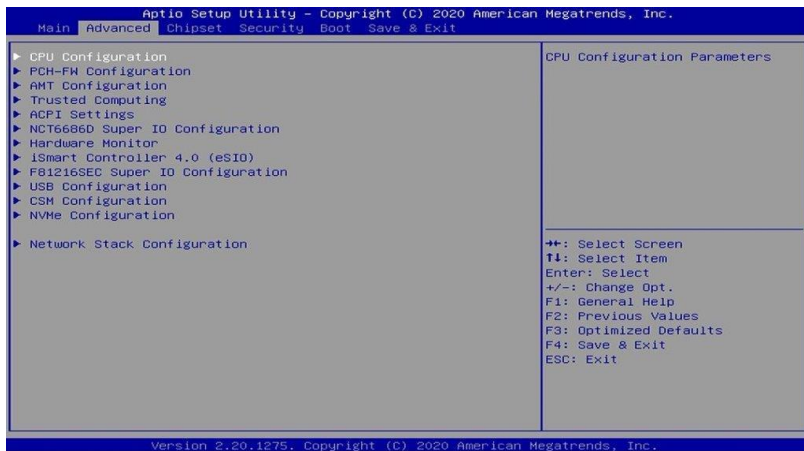

Settings	Description
CPU Configuration	Displays CPU configuration parameters
PCH-FW Configuration*	Configures management engine technology parameters
AMT Configuration*	Configures AMT settings.
Trusted Computing	Trusted computing settings.
ACPI Settings	Displays system ACPI parameters.
NCT6686D Super IO Configuration	Displays system super IO chip parameters
Hardware Monitor	Shows super IO monitor hardware status
iSmart Controller 4.0	Sets up the power on time for the system.
F81216SEC Super IO Configuration	Displays super IO chip parameters.
USB Configuration	Displays USB configuration parameters.
CSM Configuration	Enables / Disables option ROM execution settings, etc.
NVMe Configuration	NVMe Device Options Settings
Network Stack Configuration	Network Stack Settings

\* These two configurations are available on MB997AF and MB997AF-C246 motherboard models, but not on MB997EF.

## 4.4.1 CPU Configuration

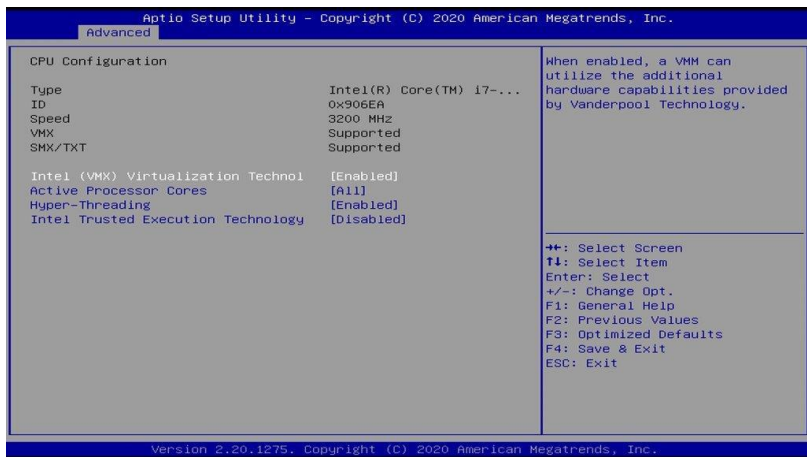

BIOS Setting	Description
Intel (VMX) Virtualization Technology	When enabled, a VMM can utilize the additional hardware capabilities provided by Vanderpool Technology.
Active Processor Cores	Number of cores to enable in each processor package. Options: All, 1, 2, 3, 4, 5
Hyper-Threading	Options: Enabled, Disabled.
Intel Trusted Execution Technology	Options: Enabled, Disabled.



## 4.4.2 PCH-FW Configuration

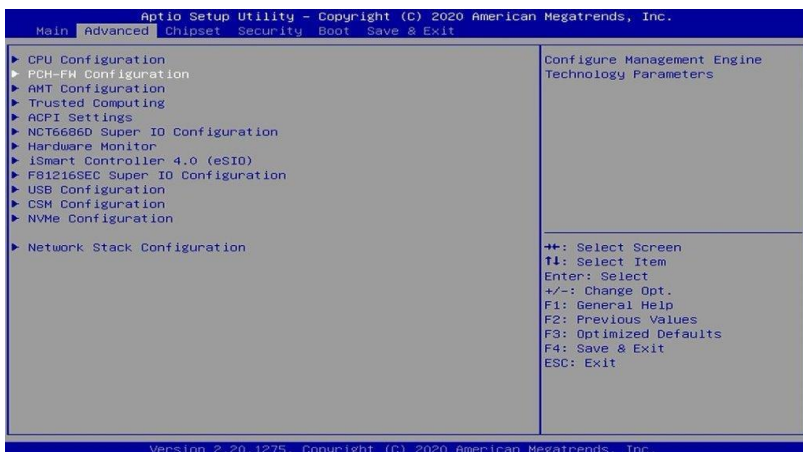

PCH-FW Configuration configures the management engine technology parameters.

**REMARKS:** PCH-FW Configuration is available on MB997AF and MB997AF-C246 motherboard models, but not on MB997EF.

### 4.4.3 AMT Configuration

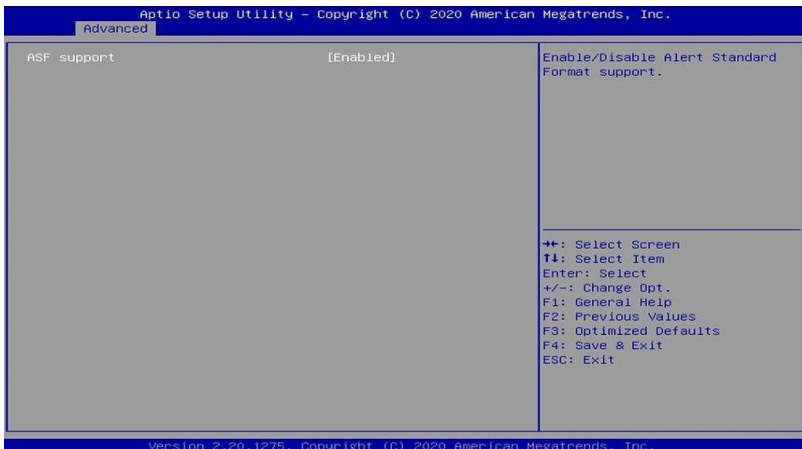
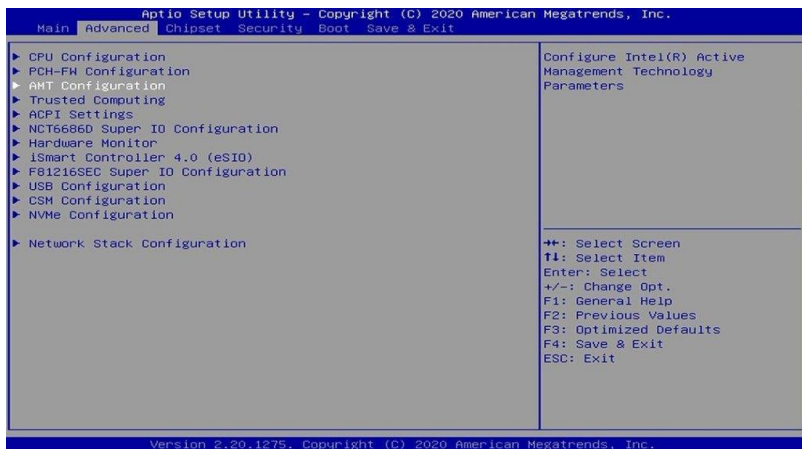

AMT Configuration configures Intel(R) Active Management Technology Parameters.

BIOS Setting	Description
ASF Support	Enable/Disable Alert Standard Format support.

**REMARKS:** AMT Configuration is available on MB997AF and MB997AF-C246 motherboard models, but not on MB997EF.

### 4.4.4 Trusted Computing

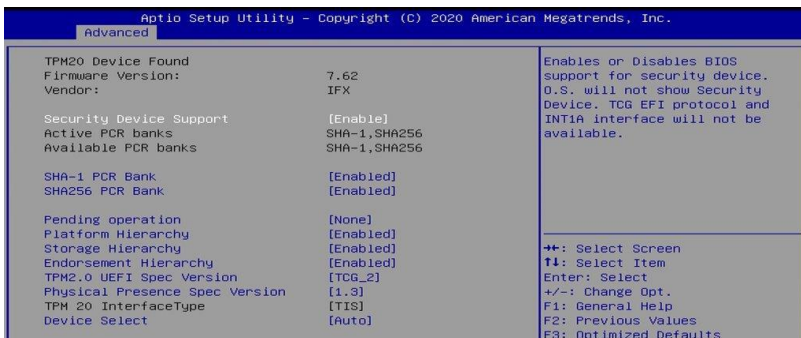

BIOS Setting	Description
Security Device Support	Enables / Disables BIOS support for security device. OS will not show security device. TCG EFI protocol and INTIA interface will not be available.
SHA-1 PCR Bank	Enable or Disable SHA-1 PCR Bank
SHA256 PCR Bank	Enable or Disable SHA256 PCR Bank
Pending operation	Schedule an operation for the security device. NOTE: Your computer will reboot during restart in order to change state of security device.
Platform Hierarchy	Enable or Disable Platform Hierarchy
Storage Hierarchy	Enable or Disable Storage Hierarchy
Endorsement Hierarchy	Enable or Disable Endorsement Hierarchy
TPM2.0 UEFI Spec Version	Select the TCG2 Spec version support: TCG_1_2: the compatible mode for Win8/Win10 TCG_2: Support new TCG2 protocol and even format for Win10 or later.
Physical Presence Spec Version	Select to tell OS to support PPI Spec Version 1.2 or 1.3. Note some HCK tests might not support 1.3.
Device Select	TPM 1.2 will restrict support to TPM 1.2 devices. TPM 2.0 will restrict to support TPM 2.0 devices. Auto will support both, with the default set to TPM 2.0 devices. If not found, TPM 1.2 devices will be enumerated.

## 4.4.5 ACPI Settings

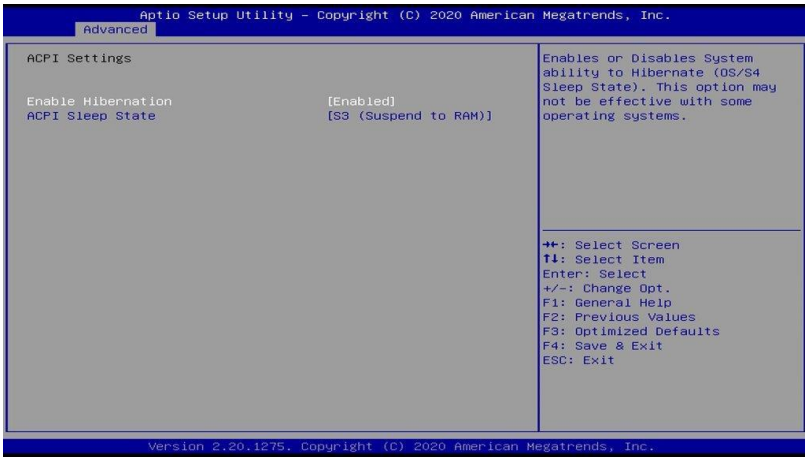

BIOS Setting	Description
Enable Hibernation	Enables / Disables the system ability to hibernate (OS/S4 Sleep State). This option may be not effective with some OS.
ACPI Sleep State	<p>Selects an ACPI sleep state where the system will enter when the Suspend button is pressed.</p> <p>Options: Suspend Disabled, S3 (Suspend to RAM)</p>

### 4.4.6 NCT66860 Super IO Configuration

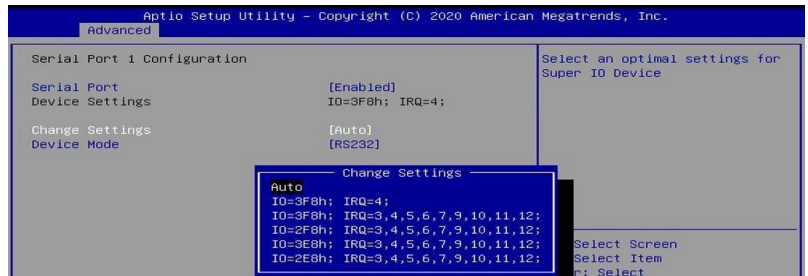
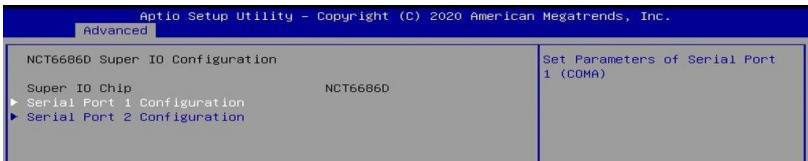

BIOS Setting	Description
Serial Port	Options: Enabled, Disabled
Change Settings	Select an optimal settings for Super IO Device. Options: <ul style="list-style-type: none"> <li>◦ IO=2F8h; IRQ3</li> <li>◦ IO=3F8h; IRQ=3,4, 5, 6, 7,8, 9, 10, 11, 12;</li> <li>◦ IO=2F8h; IRQ=3,4, 5, 6, 7,8, 9, 10, 11, 12;</li> <li>◦ IO=3E8h; IRQ=3,4, 5, 6, 7,8, 9, 10, 11, 12;</li> <li>◦ IO=2E8h; IRQ=3,4, 5, 6, 7,8, 9, 10, 11, 12;</li> </ul>
Device Mode	Change the Serial Port mode. Options: RS232, RS422,RS485

## 4.4.7 Hardware Monitor

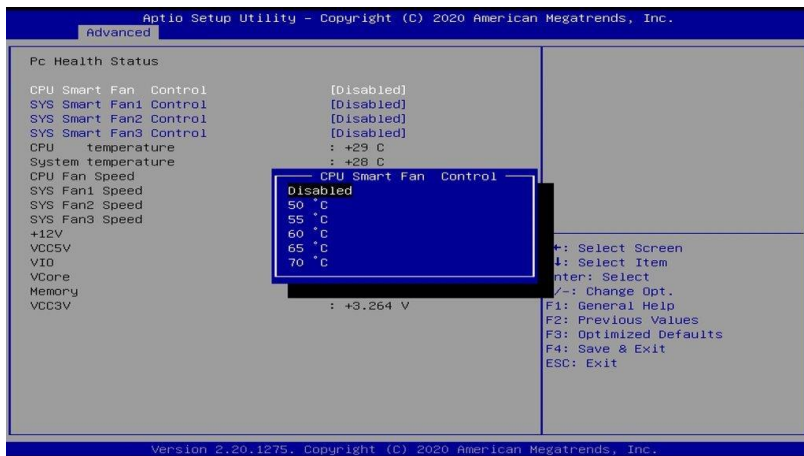

BIOS Setting	Description
CPU Smart Fan Control	Enables / Disables the CPU smart fan feature. Options: Disabled / 50 °C / 60 °C / 70 °C / 80 °C
System Smart Fan Control	Enables / Disables the system smart fan feature. Options: Disabled / 50 °C / 60 °C / 70 °C / 80 °C
Temperatures / Voltages	These fields are the parameters of the hardware monitoring function feature of the motherboard. The values are read-only values as monitored by the system and show the PC health status.
CPU Shutdown Temperature	Options: Disabled / 70 °C / 75 °C / 80 °C / 85 °C / 90 °C / 95 °C

### 4.4.8 iSmart Controller 4.0 (eSIO)



BIOS Setting	Description
Power Schedule Configuration	Setup Power Schedule Functions
Schedule Slots	<p>Sets up the hour / minute / day for the power-on schedule for the system.</p> <p>Options are None, Power On, and Power On / Off</p> <p><b>Important:</b> If you would like to set up a schedule between adjacent days, configure two schedule slots.</p> <p>For example, if setting up a schedule from Wednesday 5 p.m. to Thursday 2 a.m., configure two schedule slots. But if setting up a schedule from 3 p.m to 5 p.m. on Wednesday, configure only a schedule slot.</p>
*Standby Power on S5(ERP)	<p>[Enable] Provide the Standby Power for devices. [Disable] Shutdown the standby power.</p> <p>Options are All Enable, Enable Ethernet for WOL, and All Disable</p>
Power-On after Power Failure	Enables / Disables the system to be turned on automatically after a power failure.
Shutdown Resume	Options: Disable, Enable
Temperature Guardian	Options: Disable, Enable

**\* Standby Power on S5(ERP) is available on MB997EF only and not on the MB997AF and MB997AF-C246 motherboard models.**

## 4.4.9 F8126SEC Super IO Configuration



BIOS Setting	Description
Serial Port (1, 2, 3, 4)	Enables / Disables the serial port.
Change Settings	Select an optimal settings for Super IO Device.

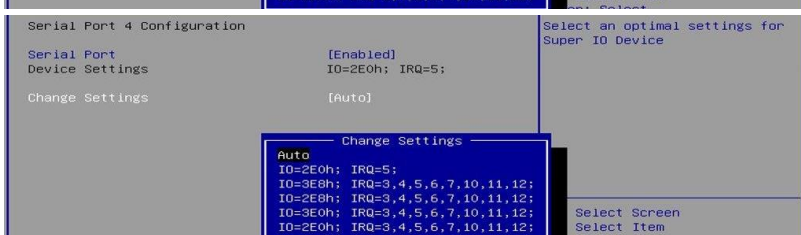
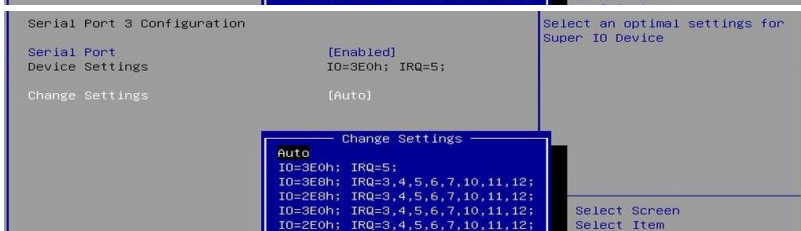
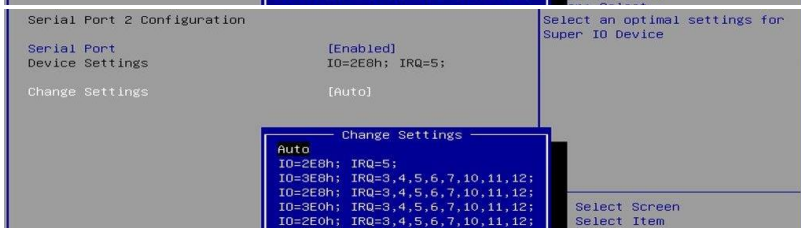
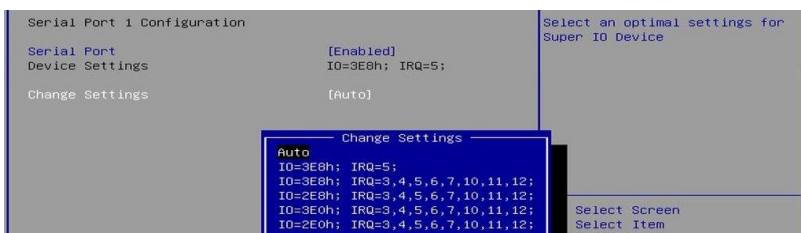



### 4.4.10 USB Configuration

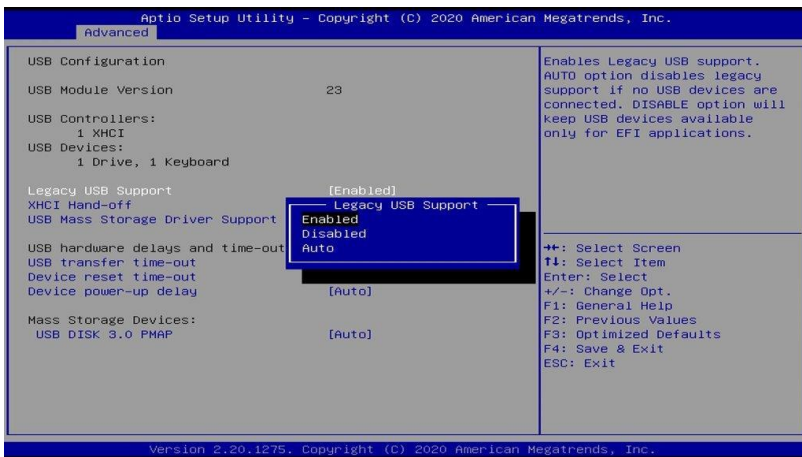

BIOS Setting	Description
Legacy USB Support	Enables Legacy USB support. <ul style="list-style-type: none"> <li>• <b>Auto</b> disables legacy support if there is no USB device connected.</li> <li>• <b>Disable</b> keeps USB devices available only for EFI applications.</li> </ul>
XHCI Hand-off	This is a workaround for OSeS without XHCI hand-off support. The XHCI ownership change should be claimed by XHCI driver.
USB Mass Storage Driver Support	Enables / Disables the support for USB mass storage driver.
USB Transfer time-out	The time-out value for control, bulk, and Interrupt transfers. Options: 1 sec / 5 sec / 10 sec / 20 sec
Device reset time-out	Seconds of delaying execution of start unit command to USB mass storage device. Options: 10 sec / 20 sec / 30 sec / 40 sec
Device power-up delay	The maximum time the device will take before it properly reports itself to the Host Controller. <b>Auto</b> uses default value for a Root port it is 100ms. But for a Hub port, the delay is taken from Hub descriptor. Options: Auto / Manual
Mass Storage Devices	Mass storage device emulation type. 'Auto' enumerates devices according to their media format. Optical deives are emulated as

---

	'CDROM'. Drives with no media will be emulate according to a drive type.
--	--

---

## 4.4.11 CSM Configuration

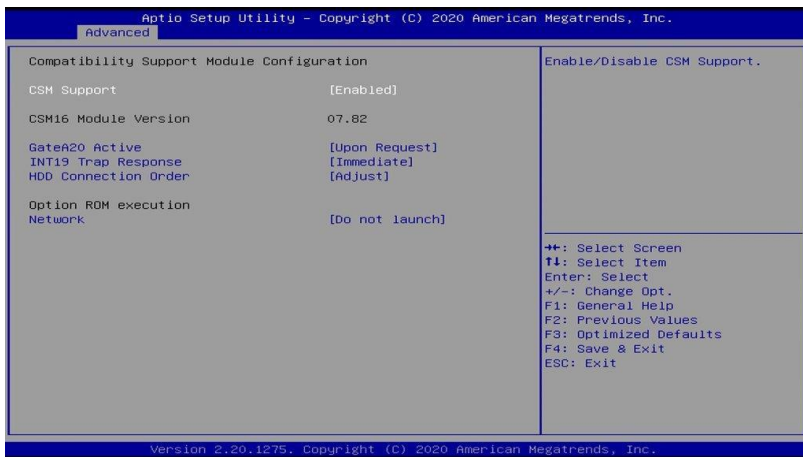

BIOS Setting	Description
CSM Support	Enables / Disables CSM support.
Gate20 Active	Upon Request – GA20 can be disabled using BIOS services. Always – do not allow disabling GA20; this option is useful when any RT code is executed above 1MB
INT19 Trap Response	BIOS reaction on INT19 trapping by Option ROM: Immediate – execute the trap right away Postponed – execute the trap during legacy boot.
HDD Connection Order	Some OS require HDD handles to be adjusted, i.e. OS is installed on drive 80h.
Network	Controls the execution of UEFI and Legacy PXE OpROM. Options: Do not launch / Legacy

## 4.4.12 NVMe Configuration

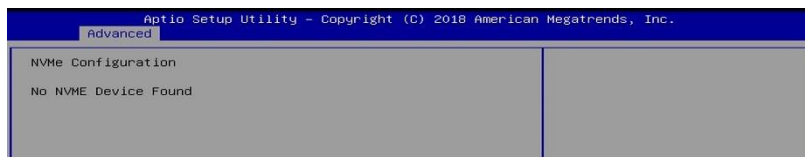

BIOS Setting	Description
NVMe Configuration	NVMe controller and drive information.

## 4.4.13 Network Stack Configuration



BIOS Setting	Description
Network Stack	Enable/Disable UEFI Network Stack.
Ipv4 PXE Support	Enable/Disable IPv4 PXE boot support. If disabled, IPv4 PXE boot support will not be available.
Ipv4 HTTP Support	Enable/Disable IPv4 HTTP boot support. If disabled, Ipv4 HTTP boot support will not be available.
Ipv6 PXE Support	Enable/Disable IPv6 PXE boot support. If disabled, IPv6 PXE boot support will not be available.
Ipv6 HTTP Support	Enable/Disable IPv6 HTTP boot support. If disabled, Ipv6 HTTP boot support will not be available.
IPSEC Certificate	Support to Enable/Disable IPSEC certificate for Ikev.
PXE boot wait time	Wait time in seconds to press ESC key to abort the PXE boot. Use either +/- or numeric keys to set the value.

---

Media detect count	Number of times the presence of media will be checked. Use either +/- or numeric keys to set the value.
--------------------	---

---

## 4.5 Chipset Settings

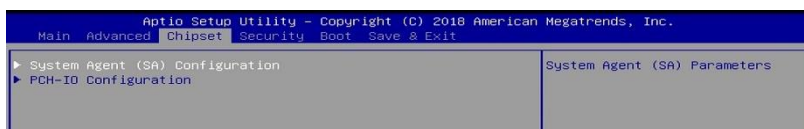

BIOS Setting	Description
System Agent (SA) Configuration	System Agent (SA) parameters
PCH-IO Configuration	PCH parameters

### 4.5.1 System Agent (SA) Configuration

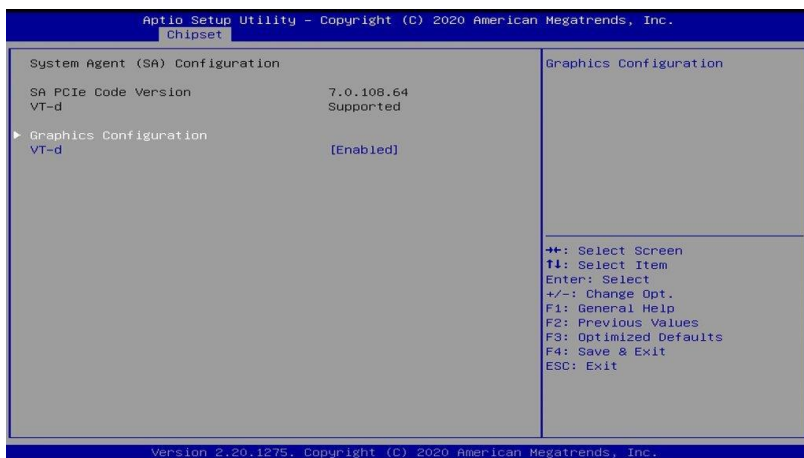

BIOS Setting	Description
Graphics Configuration	Configures the graphics settings.
VT-d	Checks if VT-d function on MCH is supported.

### 4.5.1.1. Graphics Configuration



BIOS Setting	Description
Primary Display	The default setting is Auto. Select which of IGFX/PEG/PCI Graphics device should be Primary Display or select SG for Switchable Gfx.
Select PCIE Card	Select the card used on the platform. Auto: Skp GPIO based Power Enable to dGPU Elk Creek 4: DGPU Power Enable = ActiveLow PEG Eval: DGPU Power Enable = ActiveHigh
Internal Graphics	Keep IGFX enabled based on the setup options. Options: Auto / Disabled / Enabled
GTT Size	Sets the GTT size as 2 MB, 4 MB, or 8 MB.
Aperture Size	Sets the aperture size as 128 MB / 256 MB / 512 MB / 1024 MB / 2048 MB.  Note: Above 4 GB MMIO BIOS assignment is automatically enabled when selecting 2048 MB aperture. To use this feature, disable CSM support.

## 4.5.2 PCH-IO Configuration

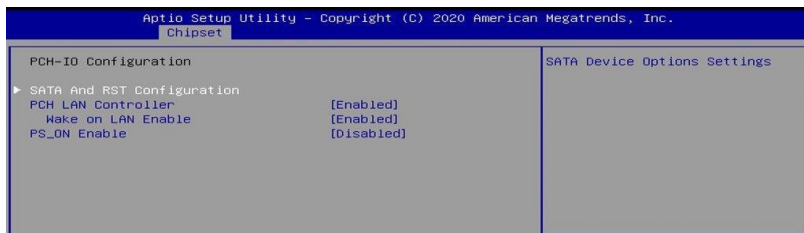

BIOS Setting	Description
SATA and RST Configuration	Configures SATA devices.
PCH LAN Controller	Enables / Disables the onboard NIC.
Wake on LAN Enable	Enables / Disables the integrated LAN to wake up the system.
PS_ON Enable	Enable or disable PS_ON ( ) support a new C10 state from the CPU on desktop SKUs that enables a lower power target that will be required by the California Energy Commission (CEC).

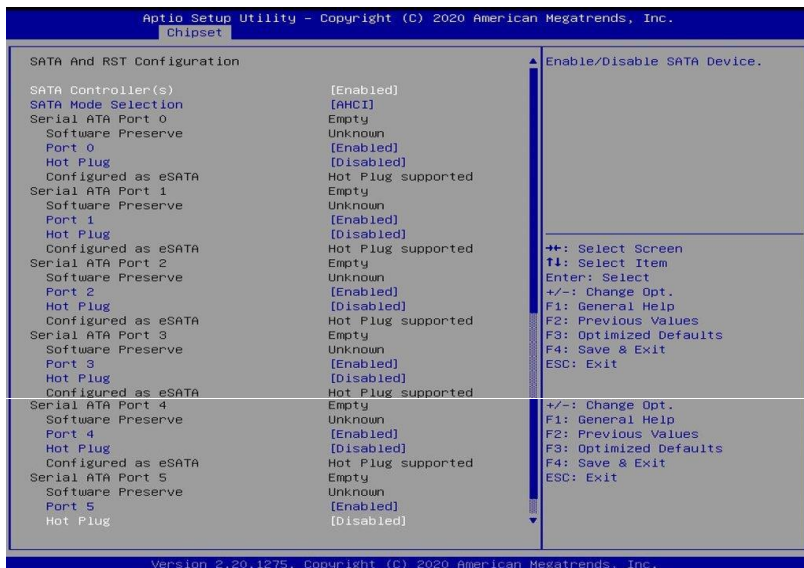



## 4.6 Security Settings

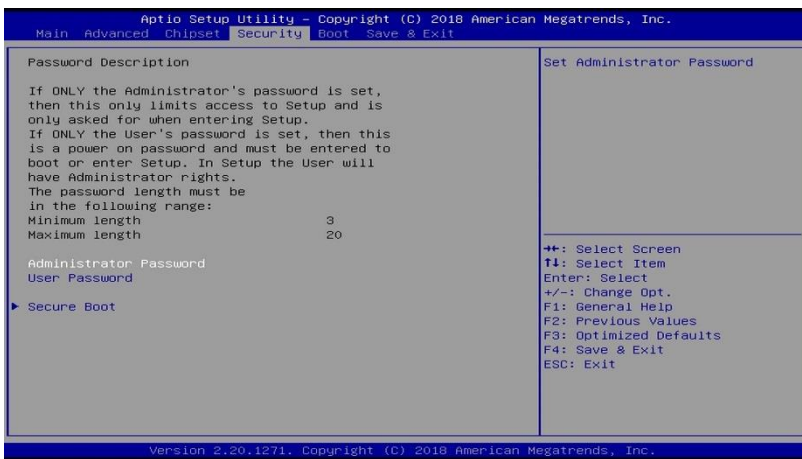

BIOS Setting	Description
Administrator Password	Sets an administrator password for the setup utility.
User Password	Sets a user password.
Secure Boot	Secure Boot feature is Active if Secure Boot is Enabled. Platform Key(PK) is enrolled and the System is in User mode. The mode change requires platform reset.
Secure Boot Mode	Secure Boot mode options: Standard or Custom. In Custom mode, Secure Boot Policy variables can be configured by a physically present user without full authentication.
Restore Factory Keys	Force System to User Mode. Install factory default Secure Boot key databases.
Key Management	Enables expert users to modify Secure Boot Policy variables without full authentication.
Factory Key Provision	Install factory default Secure Boot keys after the platform reset and while the System is in Setup mode
Enroll Efi Image	Allow the image to run in Secure Boot mode. Enroll SHA256 Hash certificate of a PE image into Authorized Signature Database (db)

Security

System Mode	Setup	Secure Boot feature is Active If Secure Boot is Enabled, Platform Key(PK) is enrolled and the System is in User mode. The mode change requires platform reset
Secure Boot	[Disabled] Not Active	
Secure Boot Mode	[Custom]	
▶ Restore Factory Keys		
▶ Reset To Setup Mode		
▶ Key Management		

++: Select Screen  
 ↑↓: Select Item  
 Enter: Select  
 +/-: Change Opt.  
 F1: General Help  
 F2: Previous Values  
 F3: Optimized Defaults  
 F4: Save & Exit  
 ESC: Exit

Security

Vendor Keys	Valid	Install factory default Secure Boot keys after the platform reset and while the System is in Setup mode
Factory Key Provision	[Disabled]	
▶ Restore Factory Keys		
▶ Reset To Setup Mode		
▶ Export Secure Boot variables		
▶ Enroll Efi Image		
Device Guard Ready		
▶ Remove 'UEFI CA' from DB		
▶ Restore DB defaults		
Secure Boot variable   Size   Keys   Key Source		
▶ Platform Key(PK)     0   No Keys		
▶ Key Exchange Keys     0   No Keys		
▶ Authorized Signatures     0   No Keys		
▶ Forbidden Signatures     0   No Keys		
▶ Authorized TimeStamps     0   No Keys		
▶ OsRecovery Signatures     0   No Keys		

++: Select Screen  
 ↑↓: Select Item  
 Enter: Select  
 +/-: Change Opt.  
 F1: General Help  
 F2: Previous Values  
 F3: Optimized Defaults  
 F4: Save & Exit  
 ESC: Exit

Security

Vendor Keys	Valid	Enroll Factory Defaults or load certificates from a file: 1.Public Key Certificate: a)EFI_SIGNATURE_LIST b)EFI_CERT_X509 (DER) c)EFI_CERT_RSA2048 (bin) d)EFI_CERT_SHAXXX 2.Authenticated UEFI Variable 3.EFI PE/COFF Image(SHA256) Key Source: Factory,External,Mixed
Factory Key Provision	[Disabled]	
▶ Restore Factory Keys		
▶ Reset To Setup Mode		
▶ Export Secure Boot variables		
▶ Enroll Efi Image		
Device Guard Ready		
▶ Remove 'UEFI CA' from DB		
▶ Restore DB defaults		
Secure Boot variable   Size   Ke		
▶ Platform Key(PK)     0		
▶ Key Exchange Keys     0   No Keys		
▶ Authorized Signatures     0   No Keys		
▶ Forbidden Signatures     0   No Keys		
▶ Authorized TimeStamps     0   No Keys		
▶ OsRecovery Signatures     0   No Keys		

++: Select Screen  
 ↑↓: Select Item  
 Enter: Select  
 +/-: Change Opt.  
 F1: General Help  
 F2: Previous Values  
 F3: Optimized Defaults  
 F4: Save & Exit  
 ESC: Exit

## 4.7 Boot Settings

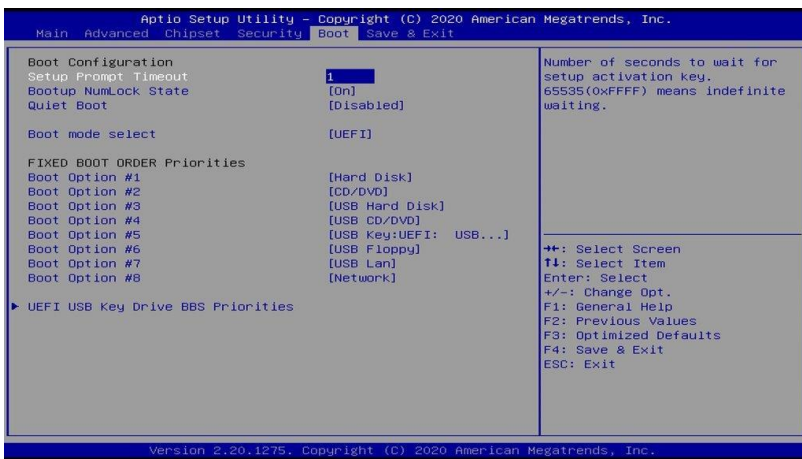

BIOS Setting	Description
Setup Prompt Timeout	Number of seconds to wait for setup activation key. 65535(0xFFFF) means indefinite waiting.
Bootup NumLock State	Selects the keyboard NumLock state.
Quiet Boot	Enables / Disables Quiet Boot option.
Boot mode select	Selects boot mode: Legacy / UEFI.
Boot Option Priorities	Sets the system boot order.

## 4.8 Save & Exit Settings

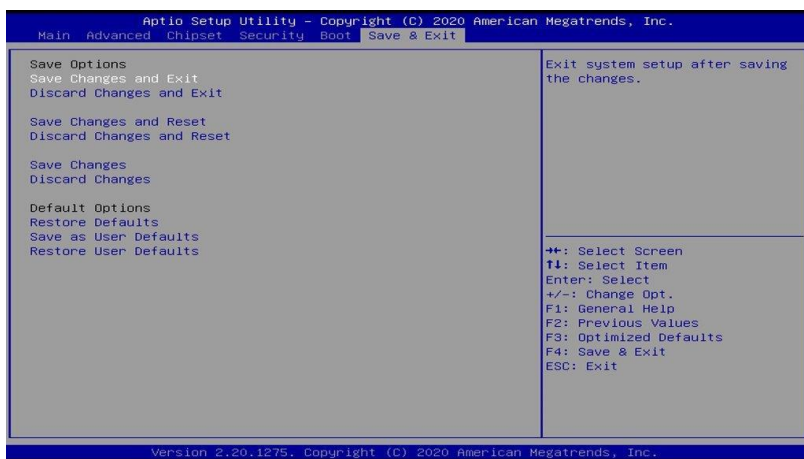

BIOS Setting	Description
Save Changes and Exit	Exits system setup after saving the changes.
Discard Changes and Exit	Exits system setup without saving any changes.
Save Changes and Reset	Resets the system after saving the changes.
Discard Changes and Reset	Resets system setup without saving any changes.
Save Changes	Saves changes done so far to any of the setup options.
Discard Changes	Discards changes done so far to any of the setup options.
Restore Defaults	Restores / Loads defaults values for all the setup options.
Save as User Defaults	Saves the changes done so far as User Defaults.
Restore User Defaults	Restores the user defaults to all the setup options.

# Appendix

This section provides the mapping addresses of peripheral devices, the sample code of watchdog timer configuration, and types of on-board connectors.

## A. I/O Port Address Map

Each peripheral device in the system is assigned a set of I/O port addresses which also becomes the identity of the device. The following table lists the I/O port addresses used.

Address	Device Description
0x00000A00-0x00000A0F	Motherboard resources
0x00000A10-0x00000A1F	Motherboard resources
0x00000A20-0x00000A2F	Motherboard resources
0x0000002E-0x0000002F	Motherboard resources
0x0000004E-0x0000004F	Motherboard resources
0x00000061-0x00000061	Motherboard resources
0x00000063-0x00000063	Motherboard resources
0x00000065-0x00000065	Motherboard resources
0x00000067-0x00000067	Motherboard resources
0x00000070-0x00000070	Motherboard resources
0x00000080-0x00000080	Motherboard resources
0x00000092-0x00000092	Motherboard resources
0x000000B2-0x000000B3	Motherboard resources
0x00000680-0x0000069F	Motherboard resources
0x0000164E-0x0000164F	Motherboard resources
0x00000020-0x00000021	Programmable interrupt controller
0x00000024-0x00000025	Programmable interrupt controller
0x00000028-0x00000029	Programmable interrupt controller
0x0000002C-0x0000002D	Programmable interrupt controller
0x00000030-0x00000031	Programmable interrupt controller
0x00000034-0x00000035	Programmable interrupt controller
0x00000038-0x00000039	Programmable interrupt controller
0x0000003C-0x0000003D	Programmable interrupt controller
0x000000A0-0x000000A1	Programmable interrupt controller
0x000000A4-0x000000A5	Programmable interrupt controller
0x000000A8-0x000000A9	Programmable interrupt controller
0x000000AC-0x000000AD	Programmable interrupt controller
0x000000B0-0x000000B1	Programmable interrupt controller

0x000000B4-0x000000B5	Programmable interrupt controller
0x000000B8-0x000000B9	Programmable interrupt controller
0x000000BC-0x000000BD	Programmable interrupt controller
0x000004D0-0x000004D1	Programmable interrupt controller
0x00001854-0x00001857	Motherboard resources
0x00003000-0x00003FFF	Intel(R) PCI Express Root Port #11 - A332
0x000003E8-0x000003EF	Communications Port (COM3)
0x000002E8-0x000002EF	Communications Port (COM4)
0x000003E0-0x000003E7	Communications Port (COM5)
0x000002E0-0x000002E7	Communications Port (COM6)
0x000003F8-0x000003FF	Communications Port (COM1)
0x000002F8-0x000002FF	Communications Port (COM2)
0x00001800-0x000018FE	Motherboard resources
0x000000F0-0x000000F0	Numeric data processor
0x00000000-0x00000CF7	PCI Express Root Complex
0x00000D00-0x0000FFFF	PCI Express Root Complex
0x00004090-0x00004097	Standard SATA AHCI Controller
0x00004080-0x00004083	Standard SATA AHCI Controller
0x00004060-0x0000407F	Standard SATA AHCI Controller
0x00000040-0x00000043	System timer
0x00000050-0x00000053	System timer
0x00002000-0x000020FE	Motherboard resources
0x00004000-0x0000403F	Intel(R) UHD Graphics 630
0x00000060-0x00000060	Standard PS/2 Keyboard
0x00000064-0x00000064	Standard PS/2 Keyboard
0x0000EFA0-0x0000EFBF	Intel(R) SMBus - A323

## B. Interrupt Request Lines (IRQ)

Peripheral devices use interrupt request lines to notify CPU for the service required. The following table shows the IRQ used by the devices on board.

Level	Function
IRQ 0	System timer
IRQ 1	Standard PS/2 Keyboard
IRQ 4	Communications Port (COM1)
IRQ 3	Communications Port (COM2)
IRQ 5	Communications Port (COM3)
IRQ 5	Communications Port (COM4)
IRQ 5	Communications Port (COM5)
IRQ 5	Communications Port (COM6)
IRQ 11	Intel(R) SMBus - A323
IRQ 12	Microsoft PS/2 Mouse
IRQ 13	Numeric data processor
IRQ 14	Intel(R) Serial IO GPIO Host Controller - INT3450
IRQ 16	High Definition Audio Controller
IRQ 45	Trusted Platform Module 2.0
IRQ 55 ~ IRQ 204	Microsoft ACPI-Compliant System
IRQ 256 ~ IRQ 511	Microsoft ACPI-Compliant System
IRQ 4294967290	Intel(R) Ethernet Connection (7) I219-V
IRQ 4294967280~87	Intel(R) I211 Gigabit Network Connection
IRQ 4294967279	Intel(R) Management Engine Interface
IRQ 4294967292	Intel(R) PCI Express Root Port #11 - A332
IRQ 4294967293	Intel(R) PCI Express Root Port #5 - A33C
IRQ 4294967294	Intel(R) PCIe Controller (x16) - 1901
IRQ 4294967289	Intel(R) UHD Graphics 630
IRQ 4294967288	Intel(R) USB 3.1 eXtensible Host Controller - 1.10 (Microsoft)
IRQ 4294967291	Standard SATA AHCI Controller



## C. Watchdog Timer Configuration

The Watchdog Timer (WDT) is used to generate a variety of output signals after a user programmable count. The WDT is suitable for use in the prevention of system lock-up, such as when software becomes trapped in a deadlock. Under these sorts of circumstances, the timer will count to zero and the selected outputs will be driven.

Under normal circumstance, you will need to restart the WDT at regular intervals before the timer counts to zero.

### Sample Code:

```
//-----
//
// THIS CODE AND INFORMATION IS PROVIDED "AS IS" WITHOUT WARRANTY OF ANY
// KIND, EITHER EXPRESSED OR IMPLIED, INCLUDING BUT NOT LIMITED TO THE
// IMPLIED WARRANTIES OF MERCHANTABILITY AND/OR FITNESS FOR A PARTICULAR
// PURPOSE.
//
//-----
#include <dos.h>
#include <conio.h>
#include <stdio.h>
#include <stdlib.h>
#include "F81966.H"
//-----
int main (int argc, char *argv[]);
void EnableWDT(int);
void DisableWDT(void);
void NCT6686EnterPageConfig(void);
void NCT6686SetPageValue(int Page, int Index, int Data);
void NCT6686ExitConfig(void);
void Delay_Loop(void);
//-----
int main (int argc, char *argv[])
{
    unsigned char bBuf;
    unsigned char bTime;
    char **endptr;

    char SIO;

    printf("Nuvoton NCT6686D watch dog program\n");

    SIO = Init_NCT6686D();
    if (SIO == 0)
    {
        printf("Can not detect NCT6686D, program abort.\n");
        return(1);
    }
    if (SIO == 0)

    if (argc != 2)
```

```

    {
        printf(" Parameter incorrect!!\n");
        return (1);
    }

    bTime = strtol (argv[1], endptr, 10);
    printf("System will reset after %d seconds\n", bTime);

    if (bTime)
    {
        EnableWDT(bTime);
    }
    else
    {
        DisableWDT();
    }

    return 0;
}
//-----
void EnableWDT(int interval)
{
    unsigned char bBuf;
    unsigned char OutPage, OutIndex, OutValue;

    NCT6686EnterPageConfig();

    OutPage = 0x02;           //Page2
    OutIndex = 0x40;         //Index 0x40 WDT Timer Configuration
    OutValue = 0x01;         //Bit1:Select 0:Second Mode 1:Minute Mode
                            //Bit0:WDT_En 1:Enable 0:Disable
    NCT6686SetPageValue(OutPage, OutIndex, OutValue);
    NCT6686ExitConfig();

    Delay_Loop();

    OutPage = 0x02;           //Page2
    OutIndex = 0x41;         //Index 0x41 WDT Timer Count
    OutValue = interval;     //Count Value
    NCT6686SetPageValue(OutPage, OutIndex, OutValue);

    NCT6686ExitConfig();
    Delay_Loop();
}
//-----
void DisableWDT(void)
{
    unsigned char bBuf;
    unsigned char OutPage, OutIndex, OutValue;

    NCT6686EnterPageConfig();

    OutPage = 0x02;           //Page2
    OutIndex = 0x40;         //Index 0x40 WDT Timer Configuration
    OutValue = 0x00;         //Bit1:Select 0:Second Mode 1:Minute Mode
                            //Bit0:WDT_En 1:Enable 0:Disable
    NCT6686SetPageValue(OutPage, OutIndex, OutValue);
    NCT6686ExitConfig();
    Delay_Loop();
}
//-----
void NCT6686EnterPageConfig(void){

```

```

    outportb(NCT6686_PAGE_CONFIG_PORT, 0xFF);
    outportb(NCT6686_PAGE_CONFIG_PORT, 0x02);
}
//-----
void NCT6686SetPageValue(int Page, int Index, int Data){
    outportb(NCT6686_PAGE_CONFIG_PORT, Page);
    outportb(NCT6686_PAGE_CONFIG_INDEX, Index);
    outportb(NCT6686_PAGE_CONFIG_DATA, Data);
}
//-----
void NCT6686ExitConfig(void){
    outportb(NCT6686_PAGE_CONFIG_PORT, NCT6686_PAGE_CONFIG_EXIT);
}
//-----
void Delay_Loop(void){

    int Timeout;

    for ( Timeout = 0; Timeout < 255; Timeout++ ) {
        outportb( 0x80, 0xAA );
            outportb( 0x80, 0xBB );
            outportb( 0x80, 0xCC );
        }
    }
//-----
//
// THIS CODE AND INFORMATION IS PROVIDED "AS IS" WITHOUT WARRANTY OF ANY
// KIND, EITHER EXPRESSED OR IMPLIED, INCLUDING BUT NOT LIMITED TO THE
// IMPLIED WARRANTIES OF MERCHANTABILITY AND/OR FITNESS FOR A PARTICULAR
// PURPOSE.
//
//-----
#include "NCT6686D.H"
#include <dos.h>
//-----
unsigned int NCT6686D_BASE;
void Unlock_NCT6686D (void);
void Lock_NCT6686D (void);
//-----
unsigned int Init_NCT6686D(void)
{
    unsigned int result;
    unsigned char ucDid;

    NCT6686D_BASE = 0x4E;
    result = NCT6686D_BASE;

    ucDid = Get_NCT6686D_Reg(0x20);
    if (ucDid == 0xD4)
        //NCT6686D
    {
        goto Init_Finish;
    }

    NCT6686D_BASE = 0x2E;
    result = NCT6686D_BASE;

    ucDid = Get_NCT6686D_Reg(0x20);
    if (ucDid == 0xD4)
        //NCT6686D

```

```

        {                goto Init_Finish;                }

        NCT6686D_BASE = 0x00;
        result = NCT6686D_BASE;

Init_Finish:
        return (result);
}
//-----
void Unlock_NCT6686D (void)
{
        outportb(NCT6686D_INDEX_PORT, NCT6686D_UNLOCK);
        outportb(NCT6686D_INDEX_PORT, NCT6686D_UNLOCK);
}
//-----
void Lock_NCT6686D (void)
{
        outportb(NCT6686D_INDEX_PORT, NCT6686D_LOCK);
}
//-----
void Set_NCT6686D_LD( unsigned char LD)
{
        Unlock_NCT6686D();
        outportb(NCT6686D_INDEX_PORT, NCT6686D_REG_LD);
        outportb(NCT6686D_DATA_PORT, LD);
        Lock_NCT6686D();
}
//-----
void Set_NCT6686D_Reg( unsigned char REG, unsigned char DATA)
{
        Unlock_NCT6686D();
        outportb(NCT6686D_INDEX_PORT, REG);
        outportb(NCT6686D_DATA_PORT, DATA);
        Lock_NCT6686D();
}
//-----
unsigned char Get_NCT6686D_Reg(unsigned char REG)
{
        unsigned char Result;
        Unlock_NCT6686D();
        outportb(NCT6686D_INDEX_PORT, REG);
        Result = inportb(NCT6686D_DATA_PORT);
        Lock_NCT6686D();
        return Result;
}
//-----

//-----
//
// THIS CODE AND INFORMATION IS PROVIDED "AS IS" WITHOUT WARRANTY OF ANY
// KIND, EITHER EXPRESSED OR IMPLIED, INCLUDING BUT NOT LIMITED TO THE
// IMPLIED WARRANTIES OF MERCHANTABILITY AND/OR FITNESS FOR A PARTICULAR
// PURPOSE.
//
//-----

```

```

#ifndef __NCT6686D_H
#define __NCT6686D_H
//-----
#define NCT6686D_INDEX_PORT (NCT6686D_BASE)
#define NCT6686D_DATA_PORT (NCT6686D_BASE+1)
//-----
#define NCT6686_PAGE_CONFIG_PORT 0xA20
#define NCT6686_PAGE_CONFIG_INDEX 0xA21
#define NCT6686_PAGE_CONFIG_DATA NCT6686_PAGE_CONFIG_INDEX + 1
#define NCT6686_PAGE_CONFIG_EXIT 0xFF
//-----
#define NCT6686D_REG_LD 0x07
//-----
#define NCT6686D_UNLOCK 0x87
#define NCT6686D_LOCK 0xAA
//-----
unsigned int Init_NCT6686D(void);
void Set_NCT6686D_LD( unsigned char);
void Set_NCT6686D_Reg( unsigned char, unsigned char);
unsigned char Get_NCT6686D_Reg( unsigned char);
//-----
#endif //__NCT6686D_H

```

## D. On-Board Connector Types

Function	Connector Name	Onboard Type	Compatible Mating Type for Reference
COM1 & COM2 RS-232/422/485 Ports	CN1	YIMTEX 40909AANSABR	D-SUB 9-pin
Front Panel Audio Connector	CN5	FOXCONN JA33331-H11P-4F	Dupont 2.54 mm 2*5-pin
Digital I/O Connector	J3	E-call 0196-01-200-100	Dupont 2.0 mm 2*5-pin
COM3, COM4, COM5, COM6 RS-232 Ports	J5 (COM6), J6 (COM5), J8 (COM4), J9 (COM3)	HAOGUO DF11-10S-PA66H	HRS DF11-10DS-2C
PS/2 Keyboard & Mouse Ports	J10	HAOGUO DF11-8S-PA66H	HRS DF11-8DS-2C
USB 2.0 Ports	J13	E-call 0126-01-2811009	Dupont 2.54 mm 2*5-pin
USB 3.1 Ports	J14	PINREX 52X-40-20GU52	USB 3.0 IDC 19-pin
Front Panel Settings Connector	J23	E-call 0126-01-203-200	Dupont 2.54 mm 2*5-pin
ATX Power Connector	J25	HAOGUO 01-0018-03	ATX 4.2 mm 2*12-pin
ATX 12V Power Connector	ATX_12V_2X1	HAOGUO 01-0018-02	ATX 4.2 mm 2*4-pin
CPU Fan Power Connector	CPU_FAN1	TECHBEST W2-03I104132S1WT(A)-L	Molex 47054-1000
System Fan Power Connector	SYS_FAN1, SYS_FAN2	TECHBEST W2-03I104132S1WT(A)-L	Molex 47054-1000

Our company network supports you worldwide with offices in Germany, Austria, Switzerland, the UK and the USA. For more information please contact:

## Headquarters

### Germany



### FORTEC Elektronik AG

Augsburger Str. 2b  
82110 Germering

Phone: +49 89 894450-0  
E-Mail: [info@fortecaq.de](mailto:info@fortecaq.de)  
Internet: [www.fortecaq.de](http://www.fortecaq.de)

## Fortec Group Members

### Austria



### Distec GmbH Office Vienna

Nuschinggasse 12  
1230 Wien

Phone: +43 1 8673492-0  
E-Mail: [info@distec.de](mailto:info@distec.de)  
Internet: [www.distec.de](http://www.distec.de)

### Germany



### Distec GmbH

Augsburger Str. 2b  
82110 Germering

Phone: +49 89 894363-0  
E-Mail: [info@distec.de](mailto:info@distec.de)  
Internet: [www.distec.de](http://www.distec.de)

### Switzerland



### ALTRAC AG

Bahnhofstraße 3  
5436 Würenlos

Phone: +41 44 7446111  
E-Mail: [info@altrac.ch](mailto:info@altrac.ch)  
Internet: [www.altrac.ch](http://www.altrac.ch)

### United Kingdom



### Display Technology Ltd.

Osprey House, 1 Osprey Court  
Hinchingsbrooke Business Park  
Huntingdon, Cambridgeshire, PE29 6FN

Phone: +44 1480 411600  
E-Mail: [info@displaytechnology.co.uk](mailto:info@displaytechnology.co.uk)  
Internet: [www.displaytechnology.co.uk](http://www.displaytechnology.co.uk)

### USA



### Apollo Display Technologies, Corp.

87 Raynor Avenue, Unit 1  
Ronkonkoma, NY 11779

Phone: +1 631 5804360  
E-Mail: [info@apolloDisplays.com](mailto:info@apolloDisplays.com)  
Internet: [www.apolloDisplays.com](http://www.apolloDisplays.com)