



OUR GLOBAL
COMPETENCE
CENTRES

 APOLLO DISPLAY
TECHNOLOGIES



 DISTEC



 DISPLAY
TECHNOLOGY



Manual

Advantech

AIMB-U217

UTX Motherboard with Intel® Apollo Lake Atom™ Quad core E3950/E3940, HDMI/eDP, (LVDS)/DP++, 4x COMs and 3x LANs

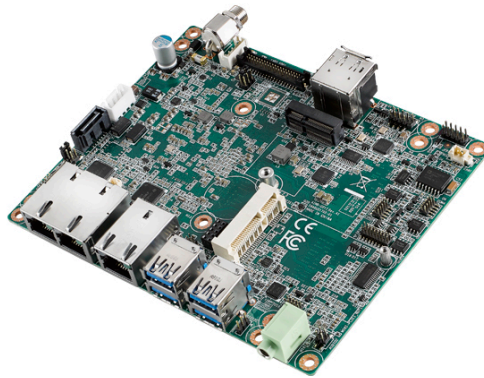

The information contained in this document has been carefully researched and is, to the best of our knowledge, accurate. However, we assume no liability for any product failures or damages, immediate or consequential, resulting from the use of the information provided herein. Our products are not intended for use in systems in which failures of product could result in personal injury. All trademarks mentioned herein are property of their respective owners. All specifications are subject to change without notice.

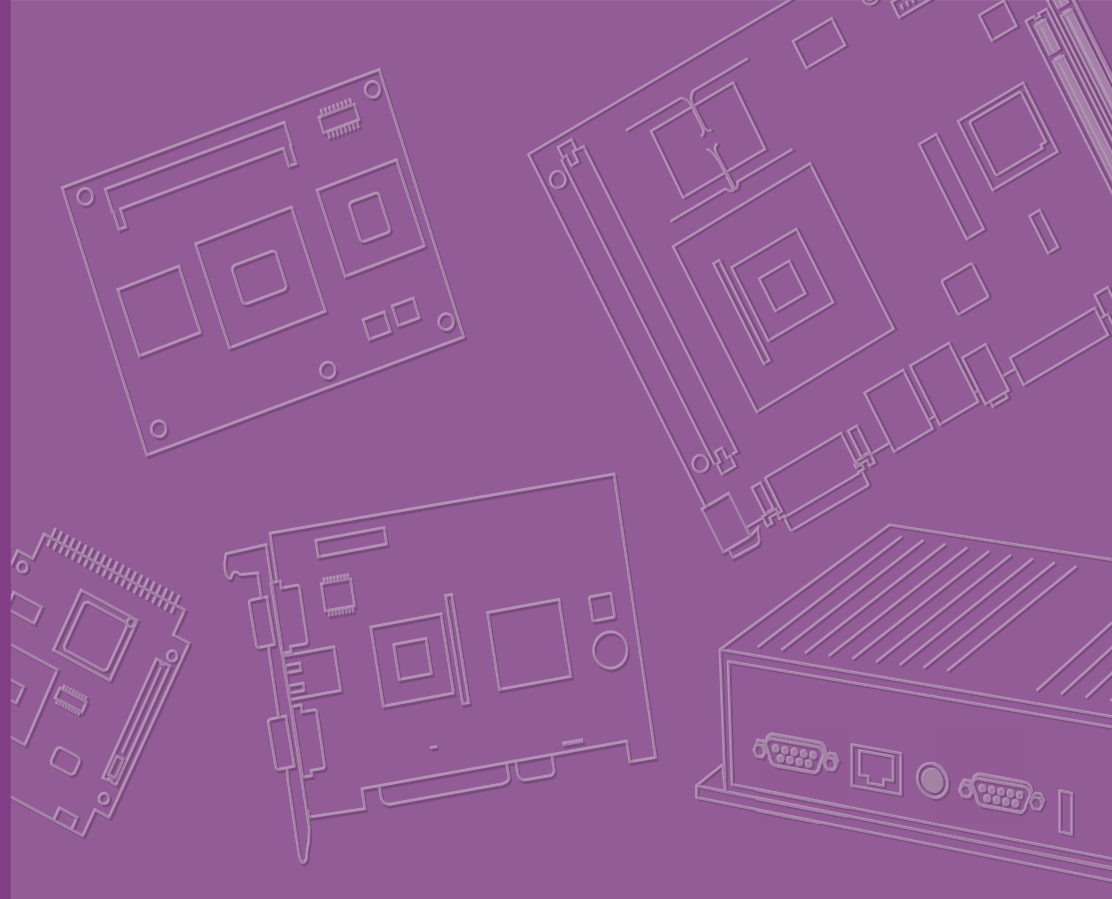

AIMB-U217

**AIMB-U217 Intel® Atom™ E3950/
E3940 Quad-Core 1.6 GHz UTX
Industrial Motherboard with
HDMI/eDP (LVDS)/DP++, 4
COMs, eMMC, Triple LAN, 4 USB,
1 MiniPCle and 1 M.2 E Key**

Copyright

The documentation and the software included with this product are copyrighted 2019 by Advantech Co., Ltd. All rights are reserved. Advantech Co., Ltd. reserves the right to improve the products described in this manual at any time without notice. No part of this manual may be reproduced, copied, translated or transmitted in any form or by any means without prior written permission from Advantech Co., Ltd. The information provided in this manual is intended to be accurate and reliable. However, Advantech Co., Ltd. assumes no responsibility for its use, nor for any infringements of the rights of third parties, which may result from its use.

Acknowledgements

IBM and PC are trademarks of International Business Machines Corporation

Intel® Atom x7-E3950/ x5-E3940 is trademark of Intel Corporation

Nuvoton is a trademark of Nuvoton Corporation

All other product names or trademarks are the property of their respective owners

Message to the Customer

Advantech Customer Services

Every Advantech product is built with the most exact specifications to ensure reliable performance in the harsh and demanding conditions typical of industrial environments. Whether your new Advantech equipment is destined for a laboratory or factory floor, be assured that your product can provide the reliability and ease of operation for which the name Advantech is renowned.

Your satisfaction is our primary concern. A guide to Advantech's customer services is provided below. To ensure that you receive the full benefit of our services, please follow the instructions below.

Technical Support

We want you to get the maximum performance from your products. Should you encounter any technical difficulties, we are available to provide assistance. Answers to the most frequently asked questions are provided in the product documentation. These answers are typically a lot more detailed than the ones provided over the phone.

So please consult this manual first. If you still cannot find the answer, gather all relevant information or questions that apply to your problem, and with the product close to hand, call your dealer. Our dealers are well trained and ready to provide the support required for you to experience the most from your Advantech products. Most of the problems reported are minor and can be easily solved over the phone.

In addition, free technical support from Advantech engineers is available every business day. We are always willing to give advice on application requirements or specific information regarding the installation and operation of any of our products.

Declaration of Conformity

FCC Class B

This device complies with the requirements in Part 15 of the FCC regulations:

Operation is subject to the following two conditions:

- This device may not cause harmful interference.
- This device must accept any interference received, including interference that may cause undesired operation.

This equipment has been tested and found to comply with the limits for a Class B digital device, pursuant to Part 15 of the FCC Regulations. These limits are designed to provide reasonable protection against harmful interference when the equipment is operated in a commercial environment. This equipment generates, uses, and can radiate radio frequency energy and, if not installed and used in accordance with the instruction manual, may cause harmful interference to radio communications. Operation of this device in a residential area is likely to cause harmful interference, in which case users are required to correct the interference at their own expense. The user is advised that any equipment changes or modifications not expressly approved by the party responsible for compliance would void compliance with the FCC regulations and, therefore, the user's authorization to operate the equipment.

Caution! *There is a risk of a new battery exploding if incorrectly installed. Do not attempt to recharge, force open, or heat the battery. Replace the battery only with the same or equivalent type recommended by the manufacturer. Discard used batteries according to the manufacturer's instructions.*



Memory Compatibility

Category	Speed	Capacity	Advantech P/N	Operating Temperature	Result
DDR3L	1866	8GB	SQR-SD3I-8G1K8SNLB	-40 to 85	Pass
DDR3L	1866	8GB	SQR-SD3M-8G1K8SNLB	-25 to 85	Pass
DDR3L	1866	4GB	SQR-SD3M-4G1K8SNLB	-20 to 85	Pass
DDR3L	1600	8GB	AQD-SD3L8GN16-SG1	0 to 85	Pass
DDR3L	1600	4GB	SQR-SD3N-4G1K6HNEC	0 to 85	Pass
DDR3L	1600	4GB	AQD-SD3L4GN16-SG1	0 to 85	Pass
DDR3L	1600	2GB	SQR-SD3N-2G1K6HNXC	0 to 85	Pass

Product Warranty (2 years)

Advantech warrants the original purchaser that its products will be free from defects in materials and workmanship for two years from the date of purchase.

This warranty does not apply to any products that have been repaired or altered by persons other than repair personnel authorized by Advantech, or products that have been subject to misuse, abuse, accident, or improper installation. Advantech assumes no liability under the terms of this warranty as a consequence of such events.

Because of Advantech's high quality-control standards and rigorous testing, most customers never need to use our repair service. If an Advantech product is defective, it will be repaired or replaced at no charge during the warranty period. For out-of-warranty repairs, users will be billed according to the cost of replacement materials, service time, and freight. Please consult your dealer for more details.

If you believe your product is defective, please follow the steps listed below.

1. Collect all information about the problem encountered (for example, CPU speed, Advantech products used, other hardware and software used, etc.). Note anything abnormal and list any onscreen messages encountered when the problem occurs.
2. Call your dealer and describe the problem. Please have your manual, product, and any relevant information readily available.
3. If your product is diagnosed as defective, obtain a return merchandise authorization (RMA) number from your dealer. This allows us to process your return more quickly.
4. Carefully pack the defective product, a completed Repair and Replacement Order Card, and proof of the purchase date (such as a photocopy of your sales receipt) in a shippable container. Products returned without a proof of purchase date are not eligible for our warranty service.
5. Write the RMA number clearly on the outside of the package and ship the product prepaid to your dealer.

Initial Inspection

Before installing the motherboard, please ensure that the following items are included in your shipment:

- 1x AIMB-U217 Intel® Atom x7-E3950/ x5-E3940 UTX Motherboard
- 1 x SATA HDD Cable
- 1 x SATA Power Cable
- 4 x Serial Port Cable
- 1 x Startup Manual
- 1 x MiniPCIe Screw
- 1 x M.2 Screw
- 1 x Warranty Card
- 1 x On-Board CPU Cooler

If any of these items are missing or damaged, contact your distributor or sales representative immediately. All AIMB-U217 devices are mechanically and electrically inspected before shipment. Thus, your product should be free of marks and scratches and in perfect working order upon receipt. While unpacking AIMB-U217, check the product for signs of shipping damage (for example, a damaged box, scratches, dents, etc.). If the device is damaged or fails to meet the specifications, notify our service department or your local sales representative immediately. Please also notify the carrier. Retain the shipping carton and packing material for inspection by the carrier. After this inspection, we will make arrangements to repair or replace the unit.

Contents

Chapter 1 General Information1

1.1	Introduction	2
1.2	Features	2
1.3	Specifications	2
1.3.1	System	2
1.3.2	Memory	2
1.3.3	Input/Output	3
1.3.4	Graphics.....	3
1.3.5	Ethernet LAN	3
1.3.6	Industrial Features	3
1.3.7	Mechanical and Environmental Specifications.....	3
1.4	Jumpers and Connectors	4
	Table 1.1: Connector / Header List.....	4
1.5	Board Layout: Jumper and Connector Locations.....	5
	Figure 1.1 Jumper and Connector Locations.....	5
	Figure 1.2 I/O Connectors	6
1.6	AIMB-U217 Board Diagram	6
	Figure 1.3 AIMB-U217 Board Diagram.....	6
1.7	Safety Precautions	7
1.8	Jumper Options.....	7
1.8.1	Setting Jumpers	7
1.8.2	CMOS Mode Selection (JCOMS1)	8
	Table 1.2: CMOS Mode Selection (JCOMS1).....	8
1.8.3	LVDS Panel Voltage Selection Header (JLVDS1).....	8
	Table 1.3: LVDS/eDP Panel Voltage Selection (JLVDS1/JLVDS2)	8
	8	
1.8.4	ATX/AT Mode Selection (PSON1).....	9
	Table 1.4: PSON1: ATX and AT Mode Selector.....	9
1.8.5	COM1 Mode Selection (CMOS1).....	9
	Table 1.5: CMOS1: COM1 Mode Selection.....	9

Chapter 2 Connecting Peripherals11

2.1	Introduction	12
2.2	LAN and USB Ports (LAN123, USB12/USB34)	12
	Table 2.1: LAN LED Indicators	12
2.3	DC Input Connector (DCIN1)	13
2.4	Serial Ports (COM1, COM2, COM3, COM4).....	13
2.5	CAN BUS Header (CAN1)	14
2.6	Display Port Connector (DP1).....	14
2.7	HDMI Connector (HDMI1).....	15
2.8	CPU FAN and System FAN Connectors (CPUFAN1 and SYSFAN1)	15
2.9	Front Panel Connectors (JFP1)	16
2.9.1	ATX Soft Power Switch (JFP1/RESET).....	16
2.9.2	Reset (JFP1/RESET).....	16
2.9.3	HDD LED (JFP1/HDDLED).....	16
2.9.4	Power LED Header (JFP1/PWR_LED).....	17
	Table 2.2: ATX Power Supply LED Status	17
2.10	HD Analog Audio Connectors (AUDIO1)	17
2.11	Serial ATA Interface (SATA1)	18
2.12	AT/ATX Mode Selection Connector (PSON1).....	18
2.13	SPI Flash Connector (SPI_CN1).....	19
2.14	Backlight Inverter Power Connector (INV1)	19
2.15	LVDS / eDP Panel Connector (LVDS_EDP1), BOM Options	20

2.16	LVDS Panel Voltage Selection Header (JLVDS1)	20
2.17	General Purpose I/O Connector (GPIO1)	21
2.18	CMOS Battery Connector (BAT1)	21
2.19	SATA Power Connector (SATA_PWR1)	22
2.20	DDR3L SODIMM Socket (DIMMA1)	22
2.21	Mini-PCIe Connector (MINI-PCIE1)	23
2.22	M.2 E key Connector (M.2_1)	23
2.23	CMOS Clear Pin Header (JCMOS1)	24
2.24	Low Pin Count Header (LPC1)	24
Chapter 3	BIOS Operation	25
3.1	Introduction	26
3.2	BIOS Setup	26
3.2.1	Main Menu	27
3.2.2	Chipset	49
3.2.3	Security	56
3.2.4	Boot	57
3.2.5	Save and Exit	58
Chapter 4	Software and Service Introduction..	59
4.1	Introduction	60
4.2	Value-Added Software Services	60
4.2.1	Software API	60
4.2.2	Software Utility	62
Chapter 5	Chipset Software Installation Utility	63
5.1	Before Installation	64
5.2	Introduction	64
Chapter 6	Graphics Setup	65
6.1	Introduction	66
6.2	Windows 10	66
Chapter 7	LAN Configuration	67
7.1	Introduction	68
7.2	Features	68
7.3	Installation	68
7.4	Windows 10 Driver Setup	68
Appendix A	Pin Assignments	69
A.1	Pin Assignments	70
A.1.1	Line-Out Connector (Audio1)	70
A.1.2	MIC-in Pin Header (Audio2)	70
A.1.3	CMOS Battery Connector (BAT1)	70
A.1.4	CAN Bus Connector (CAN1)	71
A.1.5	COM1 Pin Header (COM1)	71
A.1.6	COM2 Pin Header (COM2)	71
A.1.7	COM3 Pin Header (COM3)	72
A.1.8	COM4 Pin Header (COM4)	72

A.1.9	CPU FAN Connector (CPUFAN1)	72
A.1.10	Direct Current Input Connector (DCIN1)	73
A.1.11	Direct Current Input Connector (DCIN2)	73
A.1.12	DDR3L SO-DIMM Socket (DIMMA1)	73
A.1.13	DisplayPort + High-Definition Multimedia Interface Connector (DP1+HDMI1)	74
A.1.14	16-Bit General Purpose I/O Pin Header (GPIO1)	75
A.1.15	EDP/LVDS Backlight Inverter Power Connector (INV1)	75
A.1.16	CMOS Clear Pin Header (JCMOS1)	76
A.1.17	PWRBTN#/RESET#/HDD LED/PWR LED Pin Header (JFP1)	76
A.1.18	Voltage Selection for LVDS_EDP1 Connector (JLVDS1)	76
A.1.19	CMOS1 RI# Selection Pin Header (JSETCOM1_V1)	77
A.1.20	RJ45 #1/2 (LAN12)	77
A.1.21	RJ45 #3 (LAN3)	78
A.1.22	Low Pin Count Interface Connector (LPC1)	78
A.1.23	Low-Voltage Differential Signaling Interface/Embedded Display Port (LVDS_EDP1)	79
A.1.24	NGFF M.2 E-Key Connector for 2230 Module (M.2_1)	80
A.1.25	Mini PCIE Connector (MINI-PCIE1)	81
A.1.26	AT/ATX Mode Selection (PSON1)	82
A.1.27	Serial ATA Interface Connector (SATA1)	82
A.1.28	Serial ATA Interface Power Connector (SATAPWR1)	82
A.1.29	I2C Header (SIOI2C)	83
A.1.30	SPI Pin Header (SPI_CN1)	83
A.1.31	System FAN Connector (SYSFAN1)	83
A.1.32	Universal Serial Bus 3.0 Connector #1/2 (USB12)	84
A.1.33	Universal Serial Bus 3.0 Connector #3/4 (USB34)	85
A.1.34	Universal Serial Bus 2.0 Connector #5/6 (USB0506)	85

Chapter 1

General Information

1.1 Introduction

AIMB-U217 is the newest UTX small form factor motherboard equipped with Intel® Atom® Quad Core 1.6 GHz x7-E3950/x5-E3940 processors and DDR3L 1866 MHz up to 8GB. The palm-sized industrial motherboard measures 137 x 112mm and offers fast graphics and media performance to support triple display by HDMI1.4b, DP++1.2, eDP1.3 (or LVDS), up to 3 10/100/1000 Mbps Ethernet ports offering high-speed networking, and flexibility on storage eMMC is supported.

AIMB-U217 offers high speed, multiple I/O connectivity and expansion, including four USB3.0, optional 1 CANBus, 4 COMs (2 RS-232, 2 RS-232/422/485), 1 SATAIII 6 GB/s connector, 1 M.2 (E-Key for 2230 module type) expansion slots for easy integration, and 1 Full-Sized MiniPCIe (with mSATA supported) expansion and an optional TPM2.0 or TPM1.2 security feature.

Moreover, AIMB-U217 supports the wide range 12-24V DC power input, and extended operating temperatures of -20 to 70° C with a compliant and flexible thermal solution design. The thermal design power rating for the Intel x5-E3940 quad-core architecture is only 9.5 W, and for Atom x7-E3950 quad-core it is 12 W, allowing additional power reductions and system compressions.

All the features described above are incorporated into a space-saving, power-efficient, and cost-effective UTX small form factor.

1.2 Features

- Supports Intel® Atom x7-E3950/ x5-E3940 processors
- One 204-pin SODIMM, up to 8 GB DDR3L 1866 MHz SDRAM
- HDMI, DP++, eDP (or LVDS) Triple display or 3 independent displays
- 1 CANBus, 4 serial ports, 4 USB 3.0 and 1 SATA III ports
- 1 MiniPCIe & 1 M.2 (E key) expansion ports
- eMMC5.0 onboard flash storage (optional)
- Onboard TPM 1.2/2.0 support (optional)
- Wide DC input 12V ~24V & low power consumption design
- Fanless and wide temperature -20 ~70 board design
- Palm size 137mm x 112mm

1.3 Specifications

1.3.1 System

- **CPU:** Intel® Atom x7-E3950 Quad core 1.6 GHz & x5- E3940 Quad core 1.6 GHz
- **BIOS:** AMI 128M-bit SPI
- **SATA hard disk drive interface:** One onboard SATA connectors with a data transmission rate of up to 6 Gb/s

1.3.2 Memory

- **RAM:** 1 x SO-DIMM DDR3L 1866 MHz up to 8 GB

Note! AIMB-U217 supports 1.35 V memory only.



1.3.3 Input/Output

- **PCIe bus:** One full size MiniPCIe sharing PCIe with LAN3. NO PCIe in MiniPCIe interface when LAN3 is installed
- **Serial ports:** Four serial ports; COM1 & COM3 RS-232, COM2 RS-232/422/485 (Default RS-422) or COM4 RS-232/422/485 (Default RS-485)
- **USB port:** Supports four USB 3.0 port with a transmission rate of up to 5Gbps
- **CANBus:** One CANBus connector supported by BOM optional
- **GPIO connector:** One 16-bit general purpose input/output

1.3.4 Graphics

- **Controller:** Intel Gen 9 graphics engine
- **HDMI:** Supports up to 3840 x 2160 @ 30Hz
- **LVDS:** Supports 24-bit dual channel and up to 1920 x 1200, colay eDP (LVDS is BOM optional)
- **DP++:** Supports up to 4096 x 2160 @ 60 Hz
- **eDP:** Supports up to 3840 x 2160@60 Hz, colay with LVDS
- **Triple display:** DP + HDMI + eDP (or LVDS)

1.3.5 Ethernet LAN

- Supports up to 3 10/100/1000 Mbps Ethernet port (s) via PCI Express x1 bus, which provides a data transmission rate of 500 MB/s
- **Controller:** LAN1: Intel i211AT; LAN2: Intel i211AT; LAN3: RTL8111G

1.3.6 Industrial Features

- **Watchdog timer:** Can generate a system reset. The watchdog timer is programmable, with each unit equal to one second or one minute (255 levels)

1.3.7 Mechanical and Environmental Specifications

- **Operating temperature:**
 - AIMB-U2171 SKU: -20 ~ 70 °C (-4 ~ 158 °F) with air flow 0.7m/s
- **Storage temperature:** -40 ~ 85 °C (-40 ~ 185 °F)
- **Humidity:** 5 ~ 95% non-condensing
- **Power supply voltage:** +12V to +24V
- **Power consumption:**+12V, Windows Idle mode: 4.467W (Intel E3950 1.6GHz/DDR3L 1866MHz 8GB) 24V, Windows Idle mode: 5.109W (Intel E3950 1.6GHz/DDR3L 1866MHz 8GB)
- **Board size:** 112 x 137mm (4.4" x 5.4")
- **Board weight:** 3.5 kg

1.4 Jumpers and Connectors

The AIMB-U217 motherboard is equipped with connectors for linking the board to external devices such as hard disk drives. The board also features several jumpers for configuring the system according to specific applications.

The function of each board jumper and connector is listed in the table below. The procedure for setting jumpers is explained in subsequent sections of this chapter. Instructions for connecting external devices to the motherboard are provided in Chapter 2.

Table 1.1: Connector / Header List

	Description	Part Reference
1	Line-out connector	AUDIO1
2	MIC-in pin header	AUDIO2
3	CMOS battery connector	BAT1
4	CAN bus connector	CAN1
5	COM1 pin header (S1.27MM)	COM1
6	COM2 pin header (S1.27MM)	COM2
7	COM3 pin header (S1.27MM)	COM3
8	COM4 pin header (S1.27MM)	COM4
9	CPU FAN connector	CPUFAN1 (BOT)
10	Direct current input connector	DCIN1
11	Direct current input connector	DCIN2
12	DDR3L SO-DIMM socket	DIMMA1 (BOT)
13	DisplayPort + high-definition multimedia interface connector	DP1+HDMI1
14	16-bits general purpose I/O pin header(S1.27MM)	GPIO1
15	EDP/LVDS backlight inverter power connector	INV1
16	CMOS clear pin header	JCMOS1
17	PWRBTN#/ RESET#/HDD LED/PWR LED header	JFP1
18	Voltage selection for LVDS_EDP1 connector	JLVDS1
19	COM1 RI# selection pin header	JSETCOM1_V1
20	RJ45 #1/2	LAN12
21	RJ45 #3	LAN3
22	Low pin count interface connector	LPC1
23	Low-voltage differential signaling interface/embedded display port	LVDS_EDP1
24	NGFF M.2 E-Key connector for 2230 module	M.2_1
25	Mini PCIE connector	MINI-PCIE1
26	AT/ATX mode selection	PSON1
27	Serial ATA interface connector	SATA1
28	Serial ATA interface power connector	SATAPWR1
29	I2C header	SIOI2C
30	SPI pin header	SPI_CN1
31	System FAN connector	SYSFAN1 (BOT)

Table 1.1: Connector / Header List

32	Universal Serial Bus 3.0 connector #1/2	USB12
33	Universal Serial Bus 3.0 connector #3/4	USB34
34	Universal Serial Bus 2.0 connector #5/6	USB0506

1.5 Board Layout: Jumper and Connector Locations

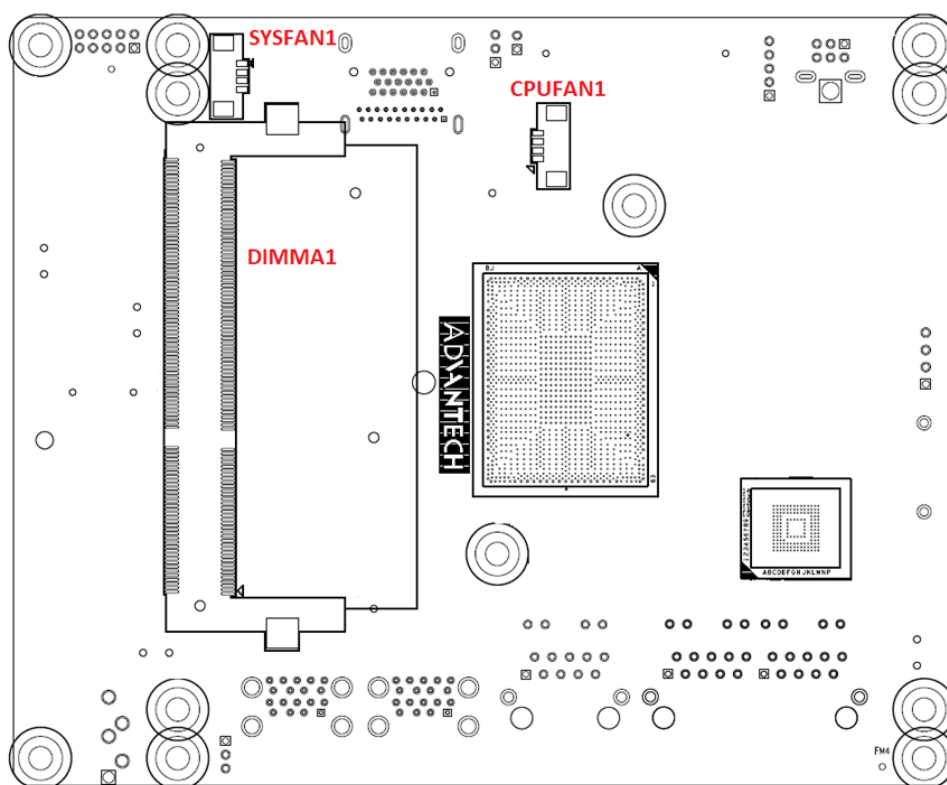
**Figure 1.1 Jumper and Connector Locations**

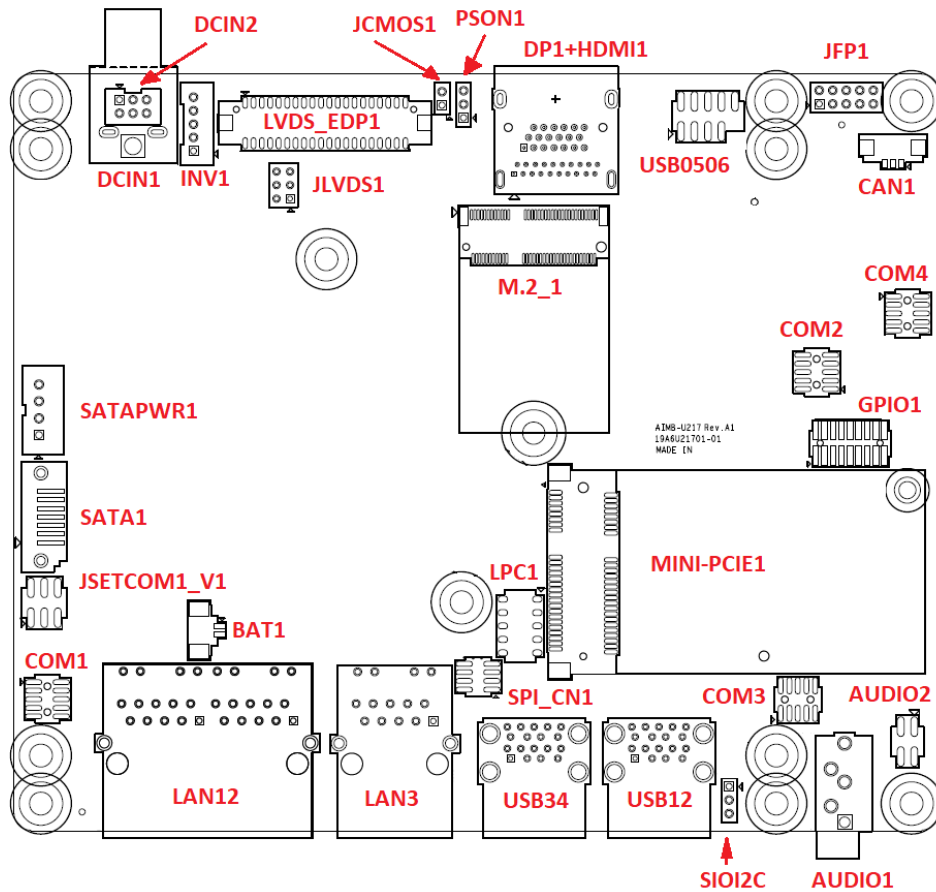

Figure 1.2 I/O Connectors

1.6 AIMB-U217 Board Diagram

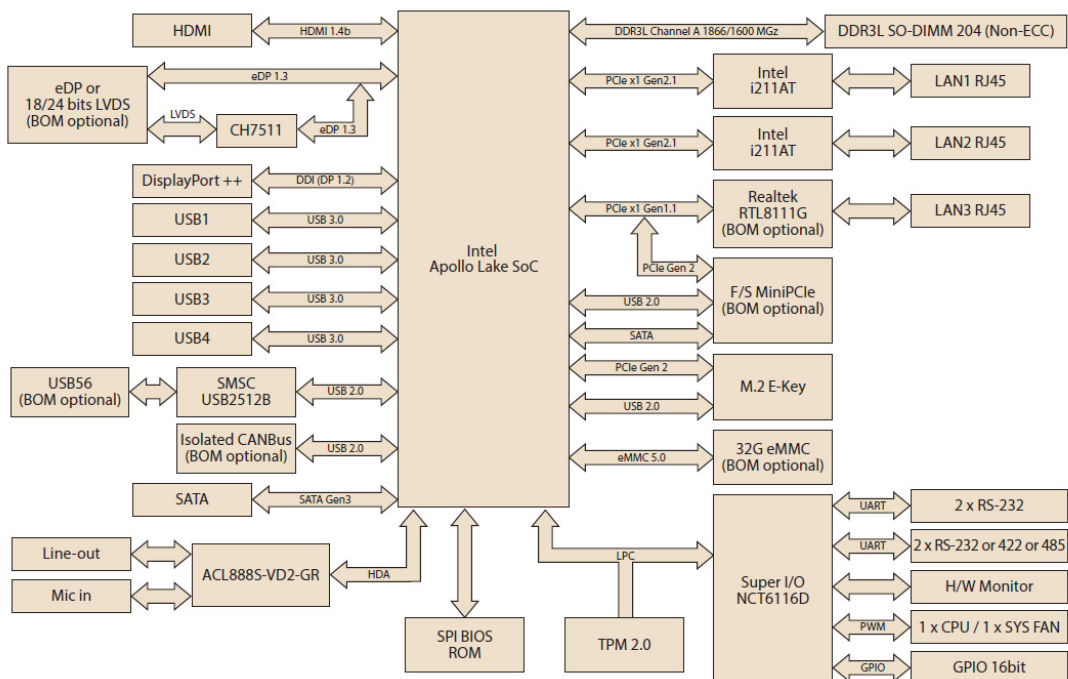

Figure 1.3 AIMB-U217 Board Diagram

1.7 Safety Precautions

Warning! *Always completely disconnect the power cord from the chassis when working with the hardware. Do not connect devices while the power is on. Sensitive electronic components can be damaged by sudden power surges. Only experienced electronics personnel should open the PC chassis.*



Caution! *Always ground yourself to remove any static charge before touching the motherboard. Modern electronic devices are very sensitive to electrostatic discharges. As a safety precaution, use a grounding wrist strap at all times. Place all electronic components on a static-dissipative surface or in a static-shielded bag when not in the chassis.*



Caution! *The computer is provided with a battery-powered real-time clock circuit. There is a danger of explosion if the battery is incorrectly replaced. Replace only with the same or equivalent type recommended by the manufacturer. Discard used batteries according to the manufacturer's instructions.*



Caution! *There is a danger of a new battery exploding if incorrectly installed. Do not attempt to recharge, force open, or heat the battery. Replace the battery only with the same or equivalent type recommended by the manufacturer. Discard used batteries according to the manufacturer's instructions.*



1.8 Jumper Options

This section provides instructions on how to configure the motherboard by setting jumpers and also outlines the default motherboard settings and options for each jumper.

1.8.1 Setting Jumpers

The motherboard can be configured according to the application requirements with the setting of jumpers. A jumper is a metal bridge used to close an electrical circuit. Jumpers typically consist of two metal pins and a small metal clip (often protected by a plastic cover) that slides over the pins to connect them. To “close” (or turn ON) a jumper, connect the pins with the clip. To “open” (or turn OFF) a jumper, simply remove the clip. Some jumpers comprise a set of three pins, labeled 1, 2, and 3. With these jumpers, simply connect either Pins 1 and 2, or Pins 2 and 3. A pair of needle-nose pliers may be necessary for setting jumpers.

1.8.2 CMOS Mode Selection (JCOMS1)

The AIMB-U217 motherboard contains a pin header that can erase CMOS data and reset the system BIOS information. To reset the CMOS data, you need to short Pins 1 & 2. This procedure resets the CMOS to its default settings.

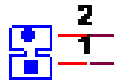

Table 1.2: CMOS Mode Selection (JCOMS1)

Pin	Signal
1	RTC RESET#
2	GND

1.8.3 LVDS Panel Voltage Selection Header (JLVDS1)

Table 1.3: LVDS/eDP Panel Voltage Selection (JLVDS1/JLVDS2)

Function	Setting
Set LVDS Panel as +5V (2-4)	A diagram of a 6-pin header with pins 1 through 6 labeled. Pins 2 and 4 are shaded, indicating they are selected for +5V.
Set LVDS Panel as +3.3V (Default) (4-6)	A diagram of a 6-pin header with pins 1 through 6 labeled. Pins 4 and 6 are shaded, indicating they are selected for +3.3V.
Set LVDS Panel as +12V (3-4)	A diagram of a 6-pin header with pins 1 through 6 labeled. Pins 3 and 4 are shaded, indicating they are selected for +12V.

1.8.4 ATX/AT Mode Selection (PSON1)

Table 1.4: PSON1: ATX and AT Mode Selector

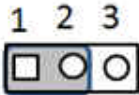
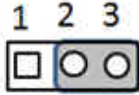
Function	Jumper Setting
AT Mode(1-2)	
ATX Mode (2-3)(Default)	

1.8.5 COM1 Mode Selection (CMOS1)

Table 1.5: CMOS1: COM1 Mode Selection

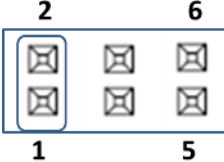
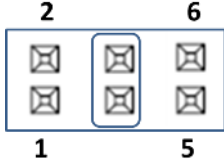
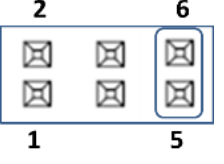
Function	Jumper Setting
Set COM1 as RI (1-2)(Default)	
Set COM1 as 5V (3-4)	
Set COM1 as 12V (5-6)	

Chapter 2

Connecting
Peripherals

2.1 Introduction

Most of the device connectors can be accessed from the top of the board during installation in the chassis. If the system is installed with several cards or the chassis is packed, partial removal of the card may be necessary to make all connections.

2.2 LAN and USB Ports (LAN123, USB12/USB34)

AIMB-U217 provides up to four USB 3.0 which are located on the rear side. The USB interface complies with the USB specification revision 2.0 that supports transmission rates of up to 480 Mbps and revision 3.0 that supports transmission rates of up to 5 Gbps.

The AIMB-U217 system is equipped with three high-performance 1000 Mbps Ethernet LAN adapters. All of them are supported by all major network operating systems. The RJ-45 jacks on the rear panel facilitate a convenient LAN connection.

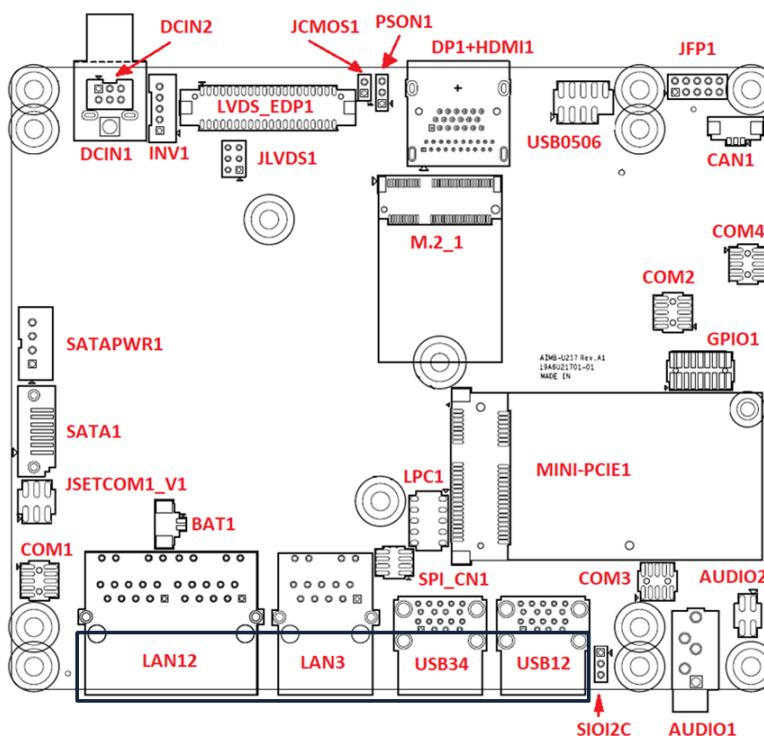
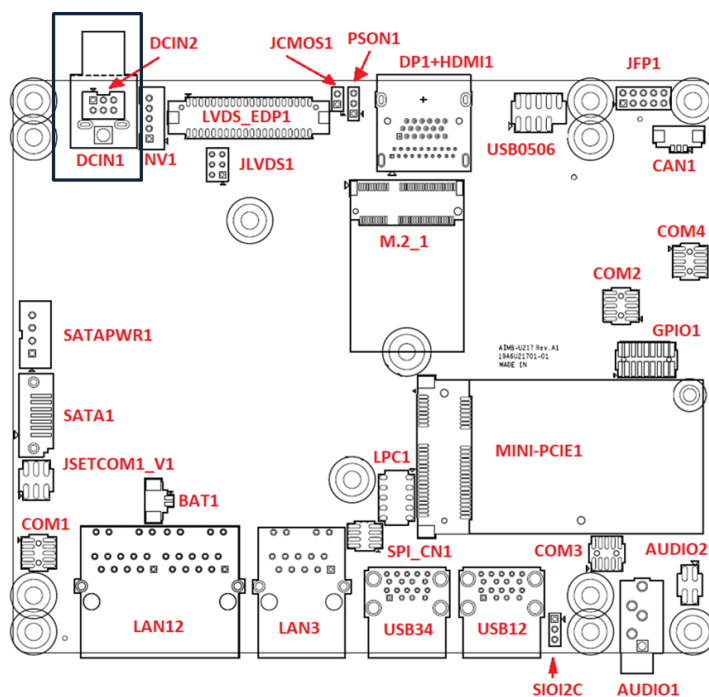

Table 2.1: LAN LED Indicators

LAN Mode	LAN Indicator
1 Gbps link on	LED1 Green on
100 Mbps link on	LED1 Orange on
Active	LED2 Green flashing

2.3 DC Input Connector (DCIN1)



2.4 Serial Ports (COM1, COM2, COM3, COM4)

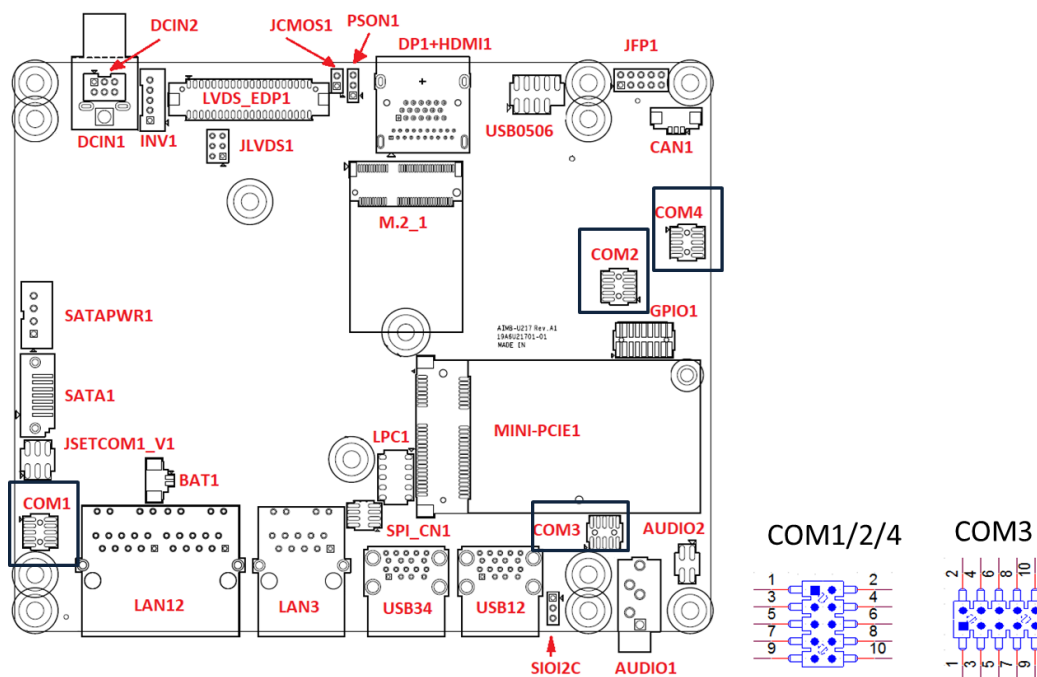

AIMB-U217 supports four serial ports. COM1 and COM3 are RS-232. COM2 is RS-232/422/485 (default is RS-422) and COM4 is RS-232/422/485 (default is RS-485). The IRQ and address ranges for both ports are fixed. However, users can disable the port or change the parameters via the system BIOS setup. Users who experience problems with a serial device are advised to check the connector pin assignments.

2.5 CAN BUS Header (CAN1)

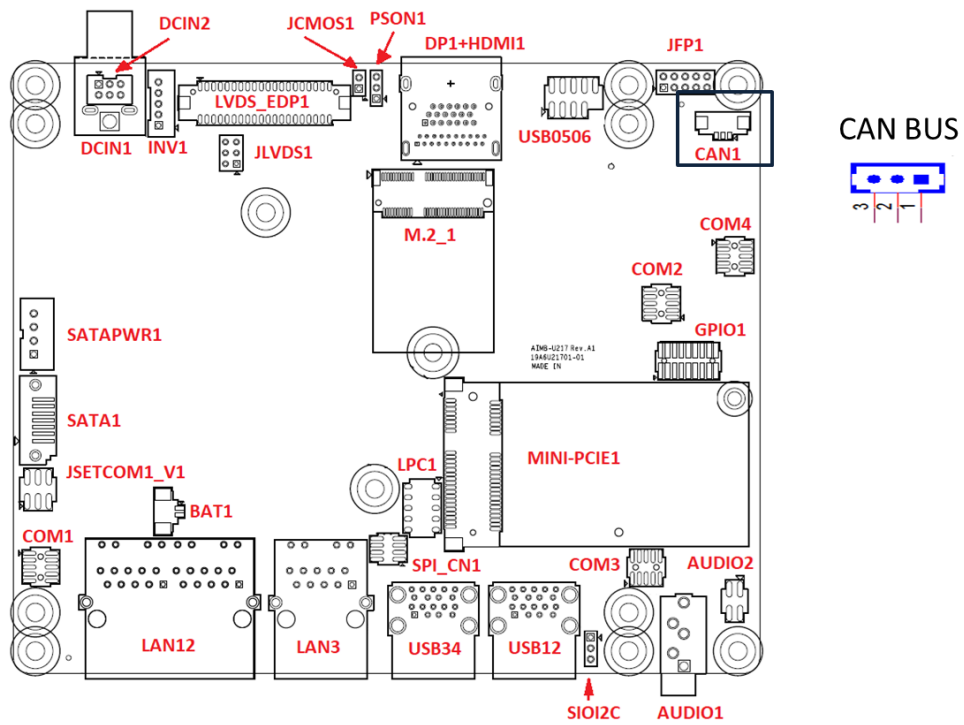

2.6 Display Port Connector (DP1)

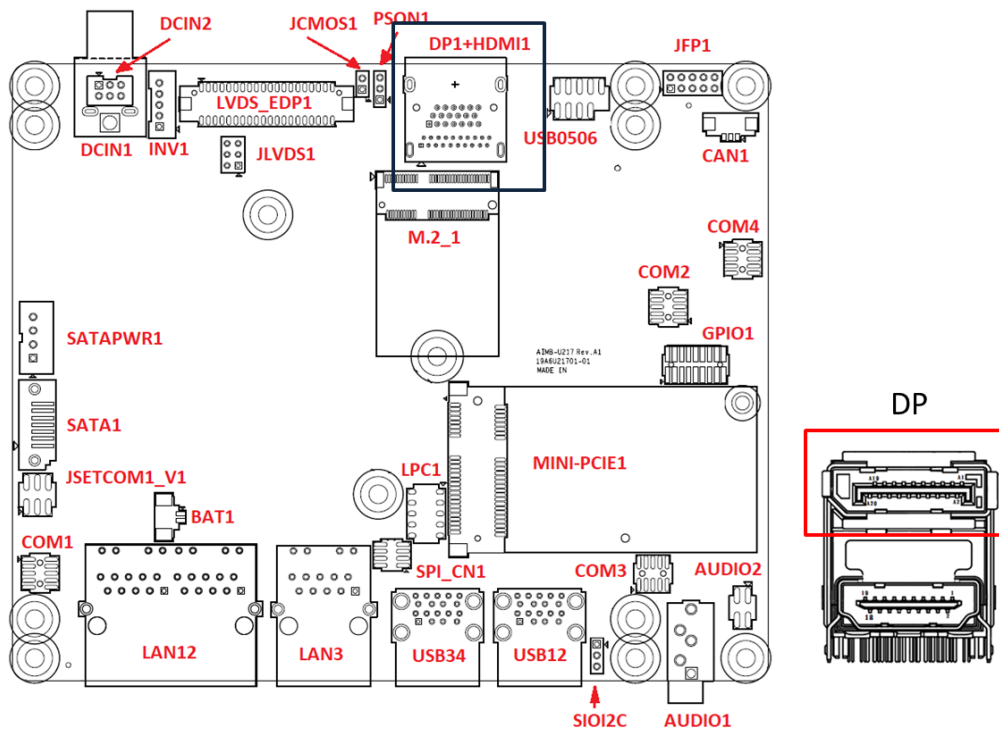

2.7 HDMI Connector (HDMI1)

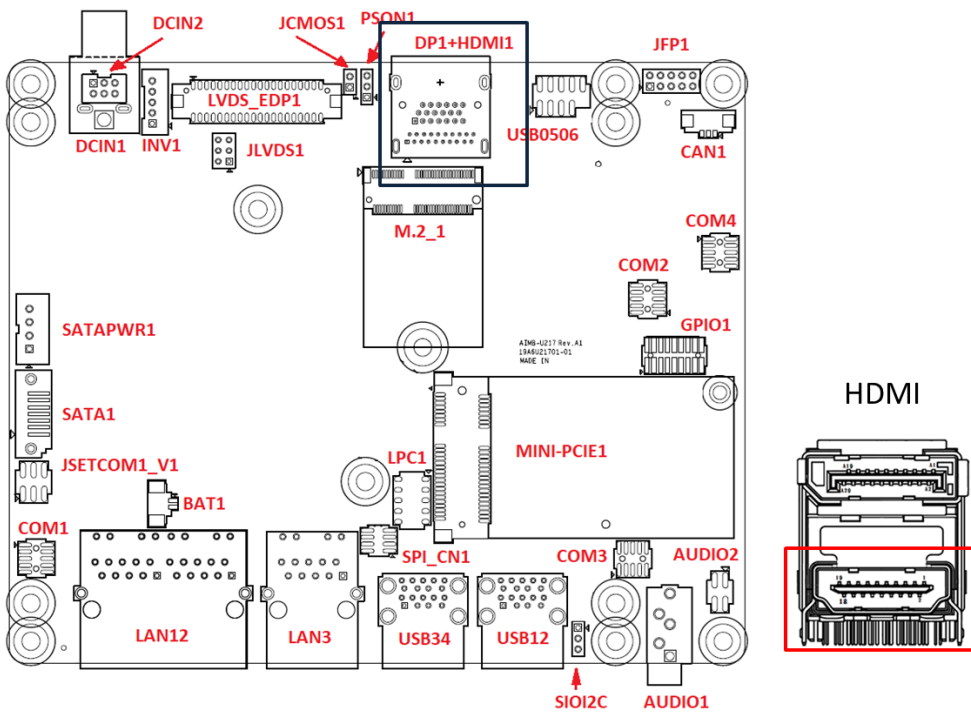

2.8 CPU FAN and System FAN Connectors (CPUFAN1 and SYSFAN1)

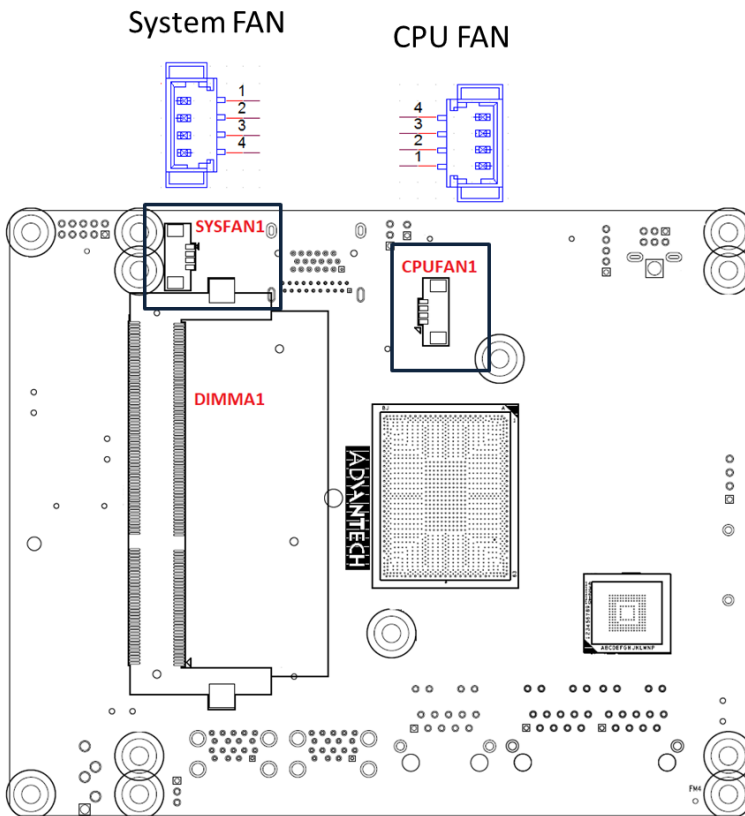

2.9 Front Panel Connectors (JFP1)

Several external switches are provided for monitoring and controlling the AIMB-U217.

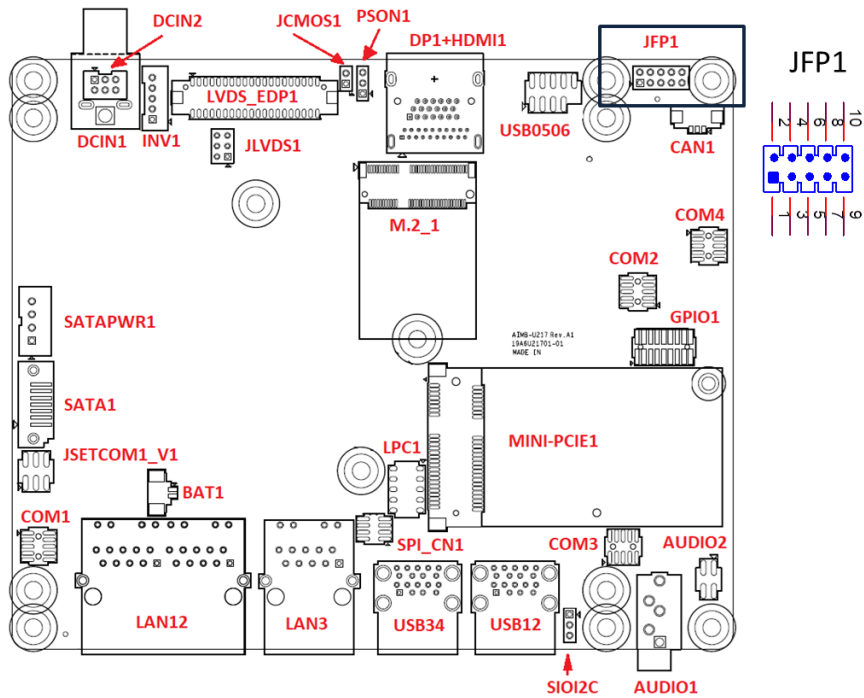

2.9.1 ATX Soft Power Switch (JFP1/RESET)

For computer cases equipped with ATX power supply, users should connect the Power On/Off button on the computer case for convenient Power On/Off functionality.

2.9.2 Reset (JFP1/RESET)

Many computer cases offer the convenience of a specific reset button. Connect the wire for the reset button.

2.9.3 HDD LED (JFP1/HDDLED)

An LED can be linked to the connector to indicate when the HDD is active.

2.9.4 Power LED Header (JFP1/PWR_LED)

Refer to Appendix A for detailed information regarding the pin assignments.

Two power supply connection modes exist. The first is the ATX power mode, where the system is powered on/off by momentarily pressing the power button. The second is the AT power mode, where the system is powered on/off using the power supply switch. The status differences indicated by the power LED are listed in the following table:

Table 2.2: ATX Power Supply LED Status

Power Mode	LED (ATX power mode) (On/off by momentarily pressing the power button)	LED (AT power mode) (Powered on/off using the power supply switch)
PSON1 jumper setting	Pins 2-3 closed	Pins 1-2 closed
System On	On	On
S3	Off	Off
S4	Off	Off
System Off	Off	Off

2.10 HD Analog Audio Connectors (AUDIO1)

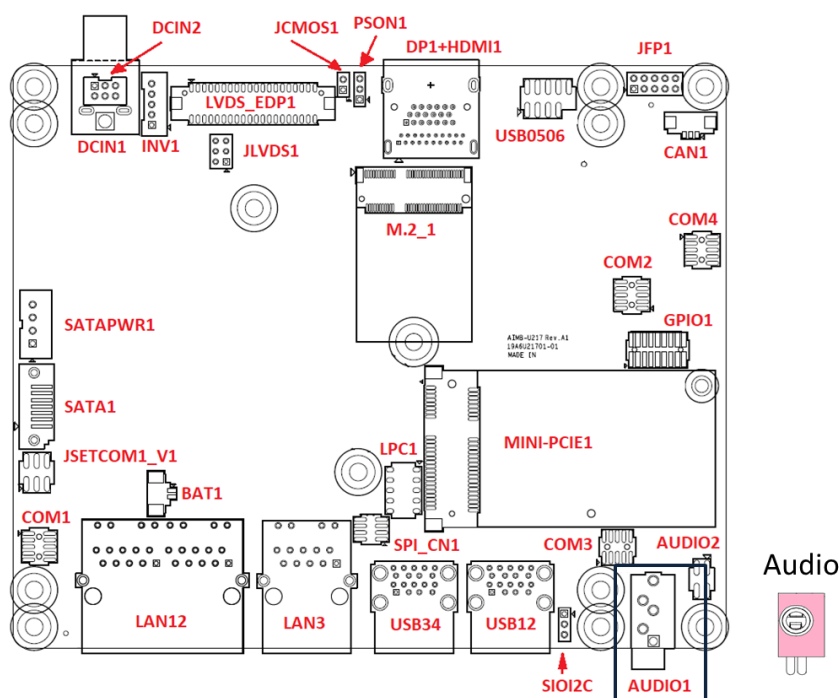

AIMB-U217 supports line-out as the default setting.

2.11 Serial ATA Interface (SATA1)

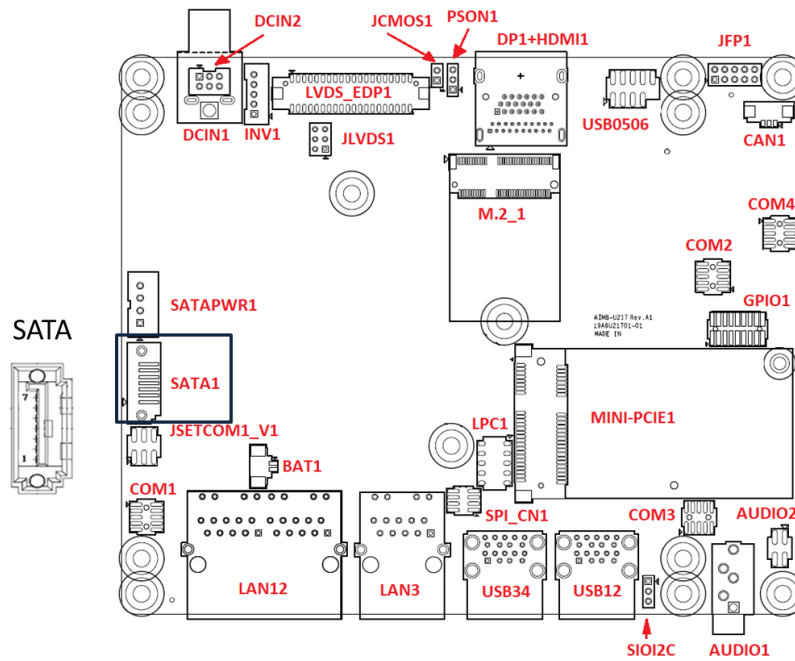

AIMB-U217 features a high-performance Serial ATA interface (up to 600 MB/s).

2.12 AT/ATX Mode Selection Connector (PSON1)

AIMB-U217 supports ATX/AT mode selection by jumper, the default setting is pin 2-3 ATX mode.

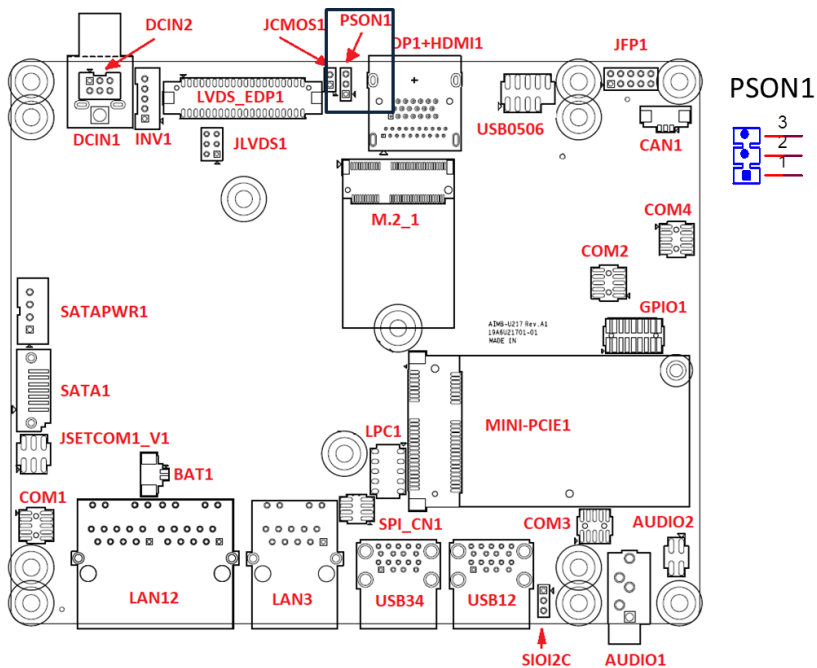

2.13 SPI Flash Connector (SPI_CN1)

The SPI flash card pin header may be used to flash the BIOS if the AIMB-U217 cannot be powered on.

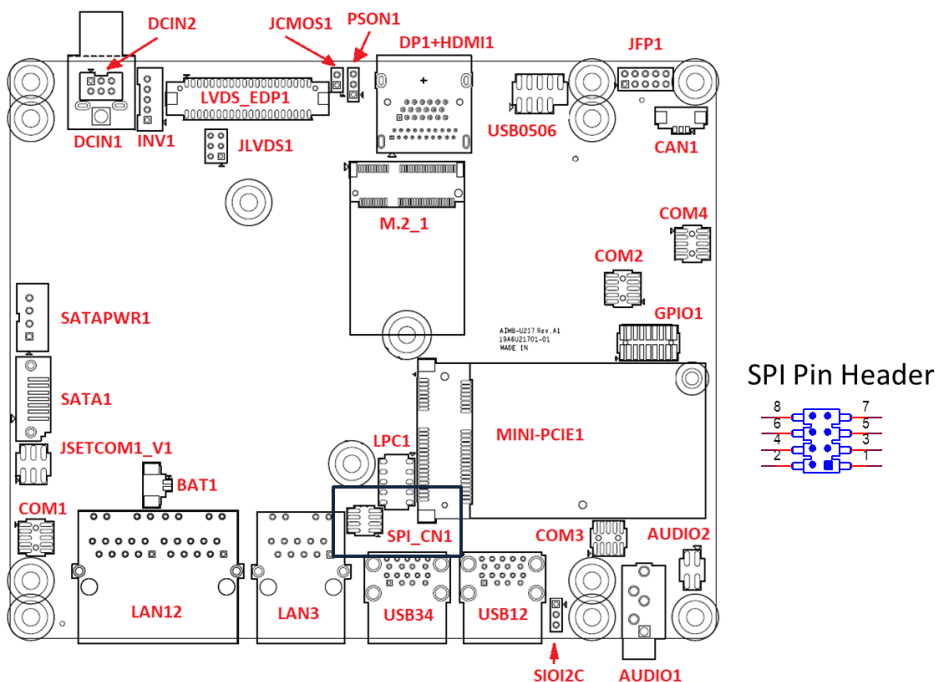

2.14 Backlight Inverter Power Connector (INV1)

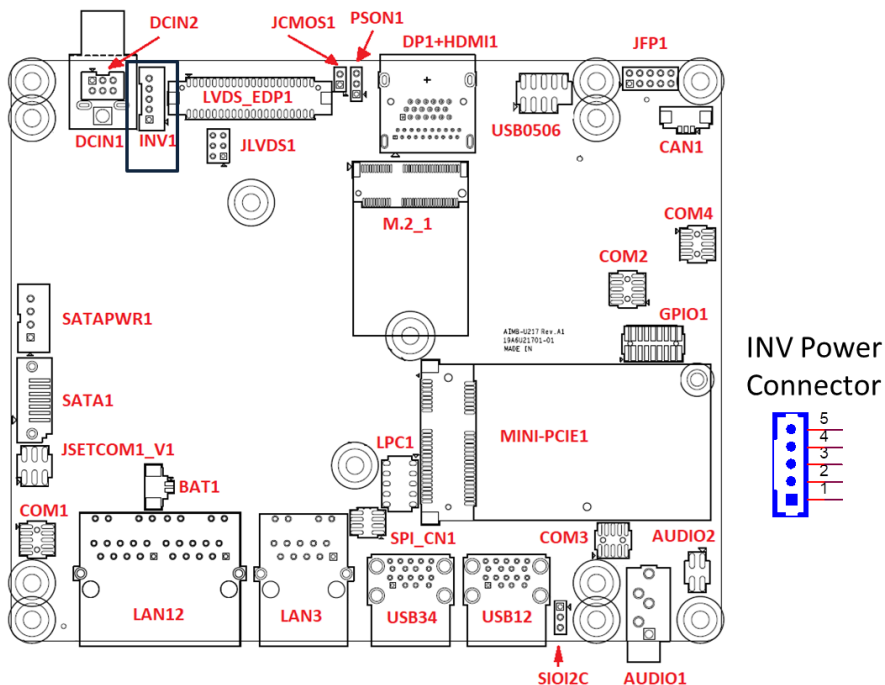

2.15 LVDS / eDP Panel Connector (LVDS_EDP1), BOM Options

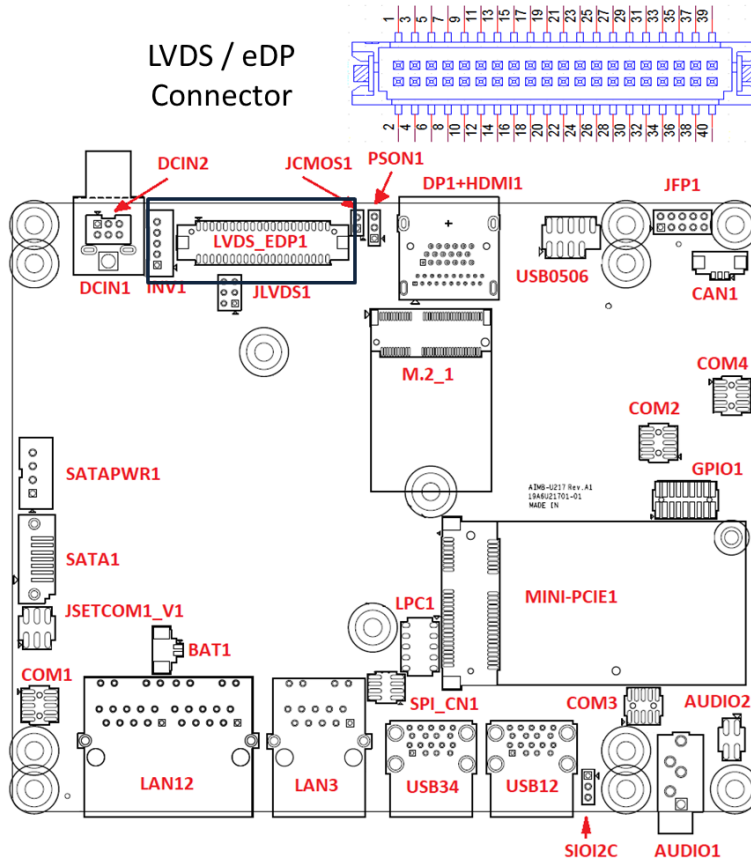

2.16 LVDS Panel Voltage Selection Header (JLVDS1)

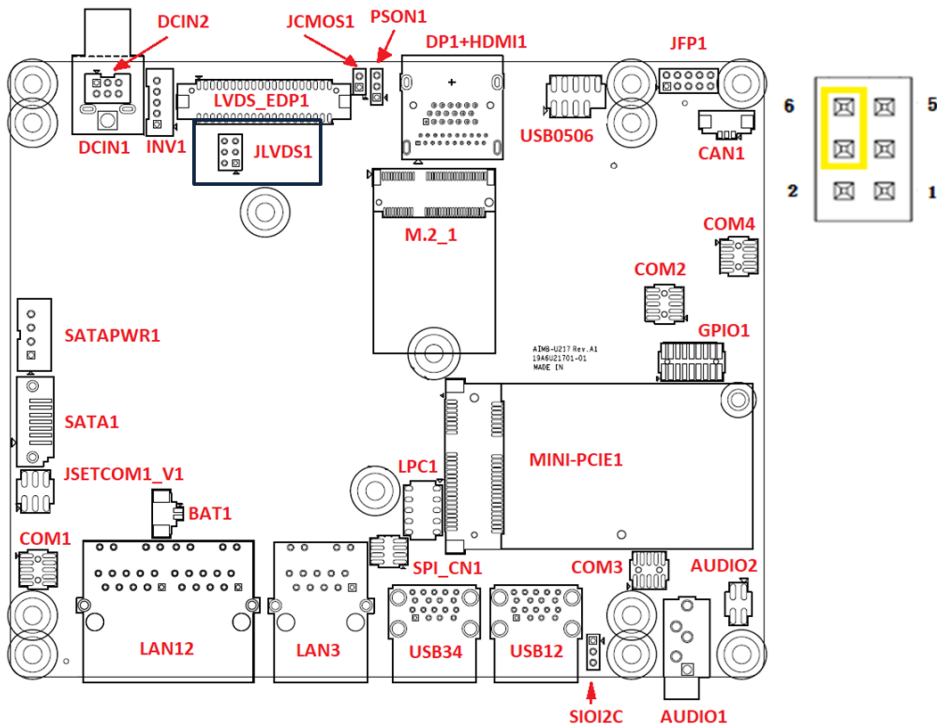

2.17 General Purpose I/O Connector (GPIO1)

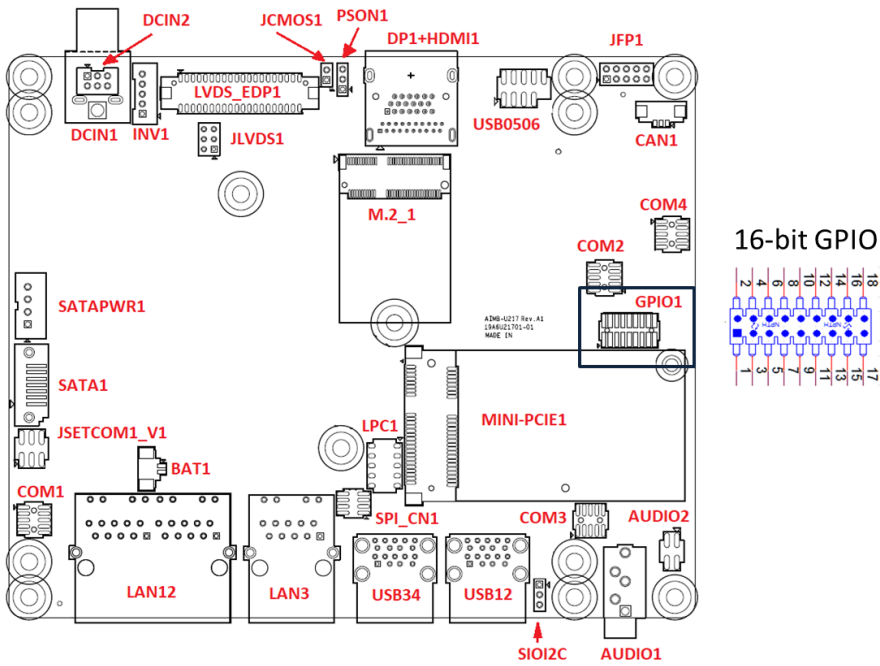

2.18 CMOS Battery Connector (BAT1)

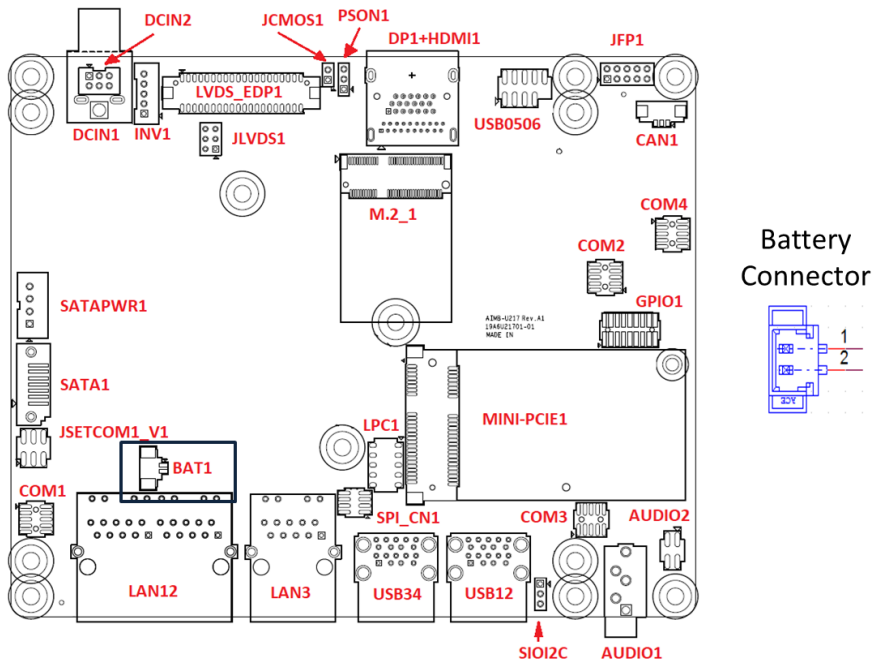

2.19 SATA Power Connector (SATA_PWR1)

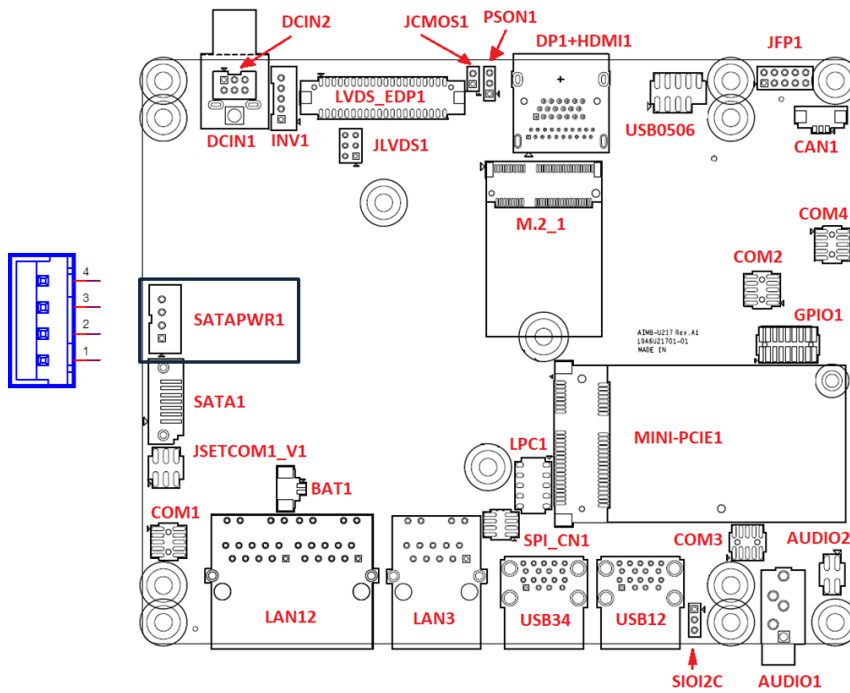

2.20 DDR3L SODIMM Socket (DIMMA1)

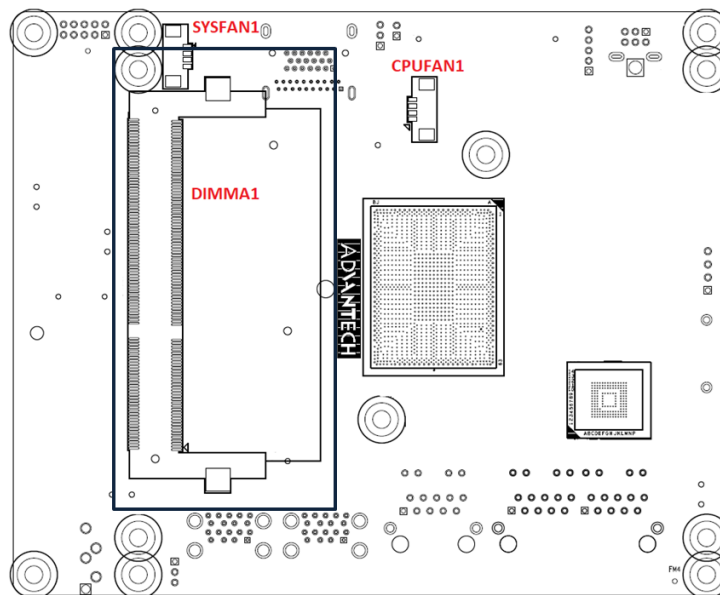

2.21 Mini-PCle Connector (MINI-PCIE1)

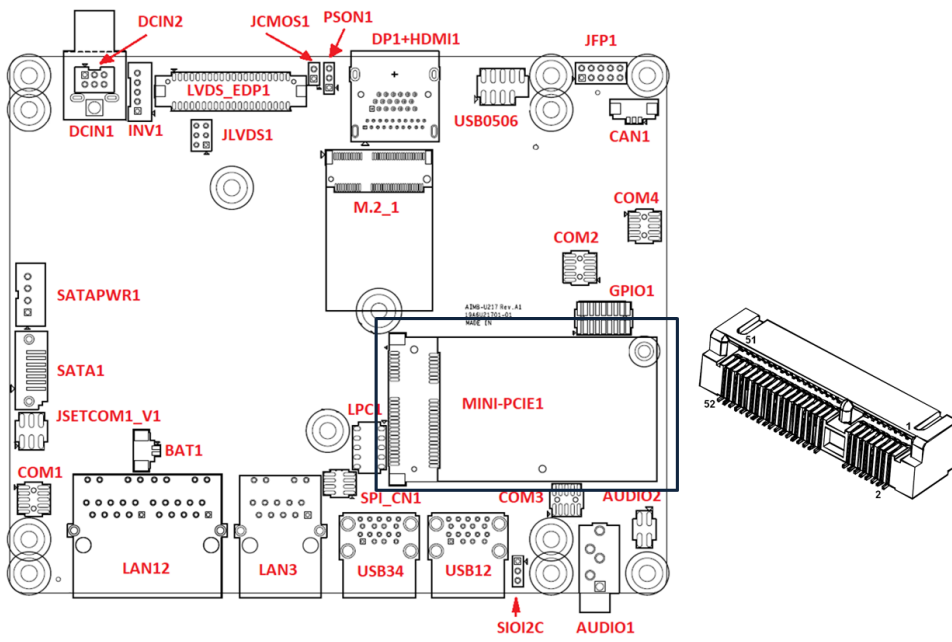

2.22 M.2 E key Connector (M.2_1)

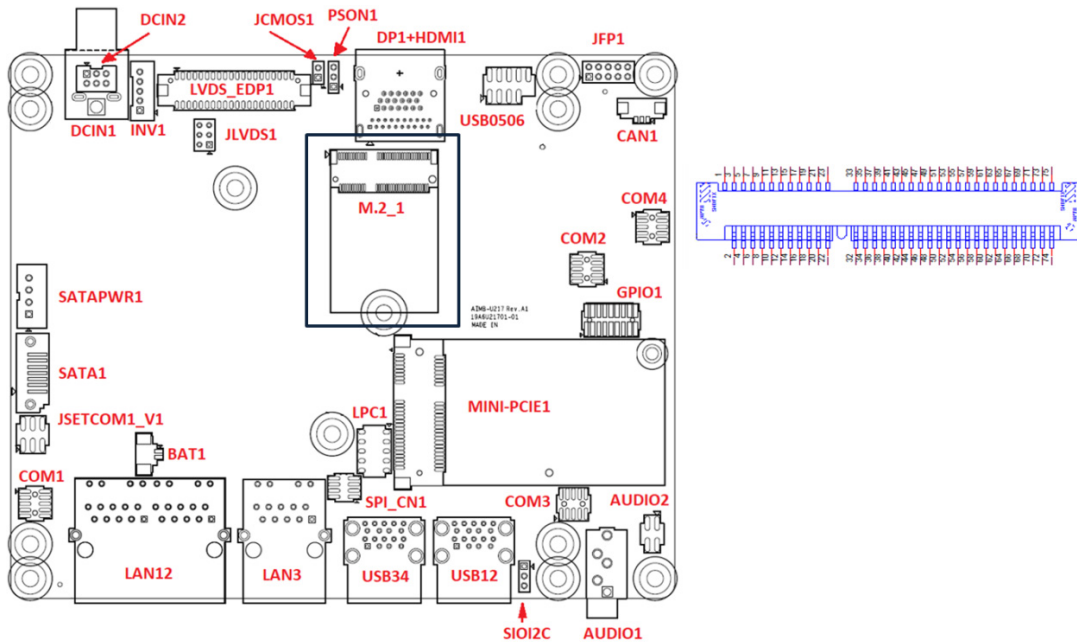

2.23 CMOS Clear Pin Header (JCMOS1)

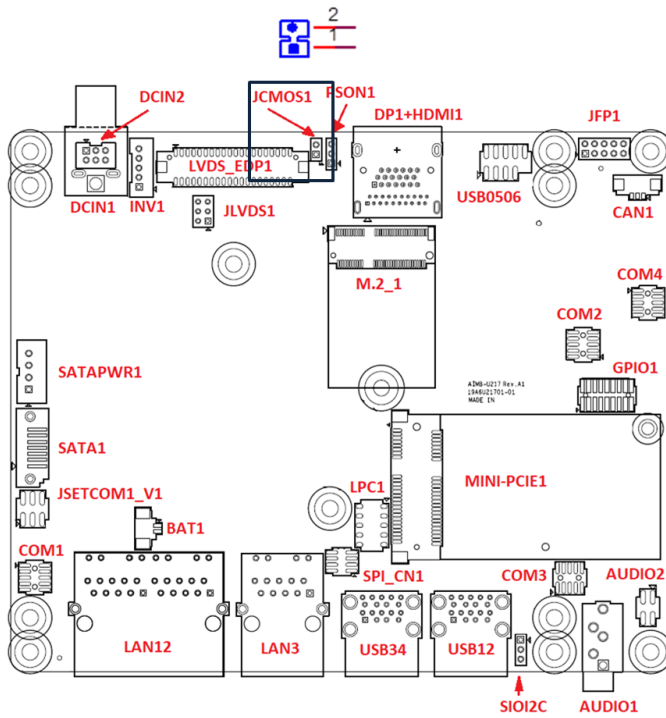

2.24 Low Pin Count Header (LPC1)

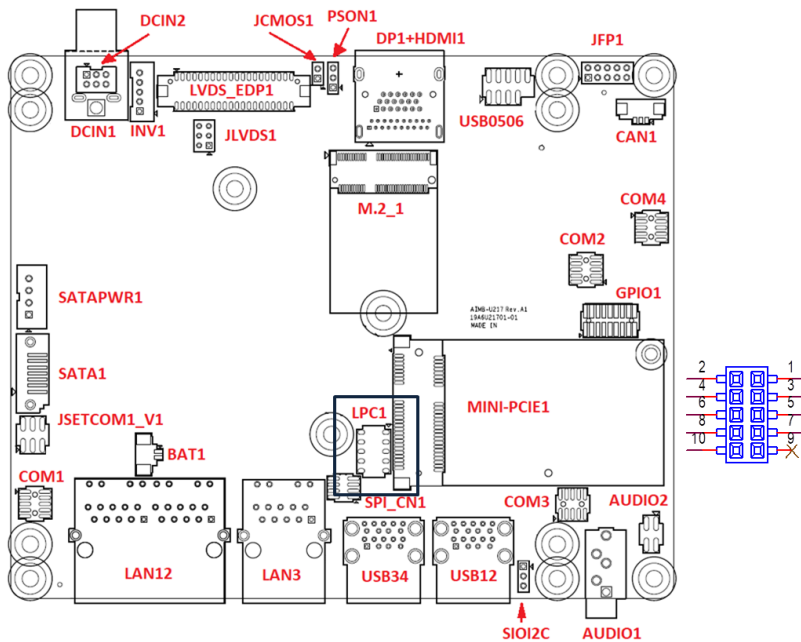

Chapter 3

BIOS Operation

3.1 Introduction

With the AMI BIOS Setup program, users can modify the BIOS settings and control the special system features. The Setup program comprises several menus with options for adjusting or turning special features on or off. This chapter describes the basic navigation of the AIMB-U217 BIOS setup menu pages.

3.2 BIOS Setup

The AIMB-U217 Series is equipped with built-in AMI BIOS and a CMOS Setup Utility that allows users to configure specific settings or activate certain system features.

The CMOS Setup Utility saves the configuration in the CMOS RAM of the motherboard. When the system power is turned off, the battery on the board supplies the necessary power to preserve the CMOS RAM.

When the power is turned on, press the button during the BIOS power-on self-test (POST) to access the CMOS Setup Utility screen.

Control Keys

< ↑ >< ↓ >< ← >< → >	Move select item
----------------------	------------------

<Enter>	Select item
---------	-------------

<Esc>	Main Menu - Quit without saving changes to the CMOS Sub Menu - Exit current page and return to the Main Menu
-------	---

<Page Up/+>	Increase the numeric value or make changes
-------------	--

<Page Down/->	Decrease the numeric value or make changes
---------------	--

<F1>	General help, for Setup Sub Menu
------	----------------------------------

<F2>	Item help
------	-----------

<F5>	Load previous values
------	----------------------

<F7>	Load setup defaults
------	---------------------

<F10>	Save all CMOS changes
-------	-----------------------

3.2.1 Main Menu

Press to enter the AMI BIOS CMOS Setup Utility and the Main Menu will appear on the screen. Use the arrow keys to select items and press <Enter> to access the submenu.

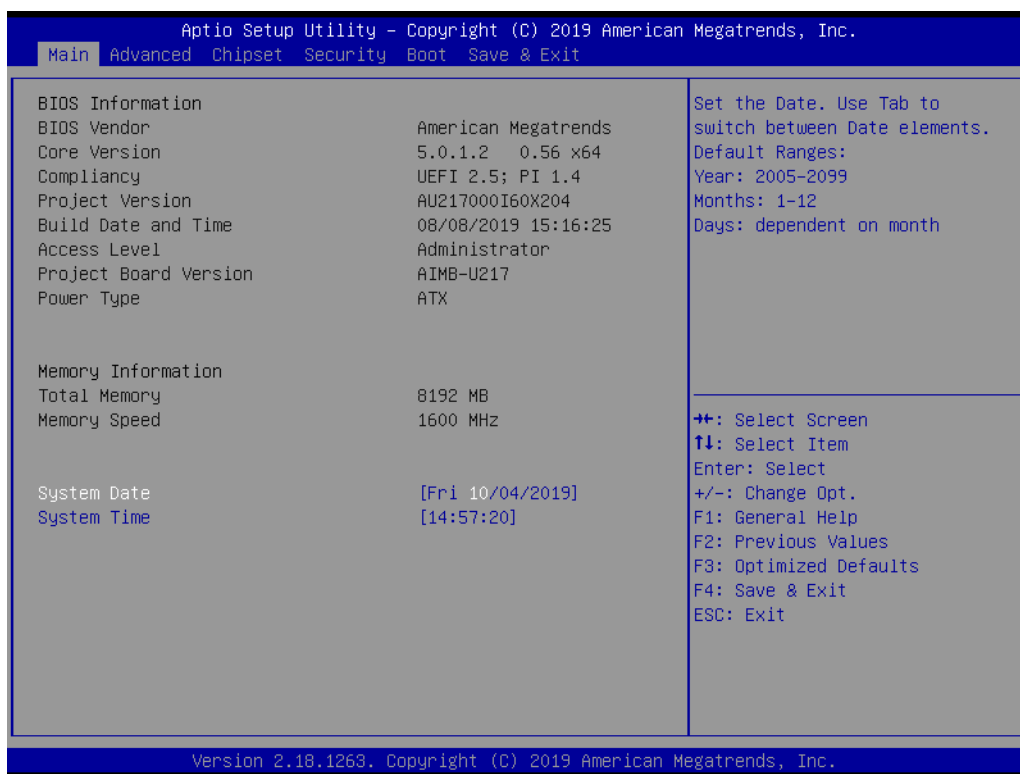

The Main BIOS setup screen has two main frames. The left frame displays all the options that can be configured. Grayed-out options cannot be configured; options in blue can. The right frame displays the key legend.

Above the key legend is an area reserved for a text message. When an option is selected in the left frame, it is highlighted in white. Often a text message will accompany it.

■ System Time/System Date

Use this option to change the system time and date. Highlight the System Time or System Date using the <Arrow> keys. Enter new values via the keyboard. Press the <Tab> or <Arrow> keys to move between fields. The date must be entered in MM/DD/YY format. The time must be entered in HH:MM:SS format.

3.2.1.1 Trusted Computing

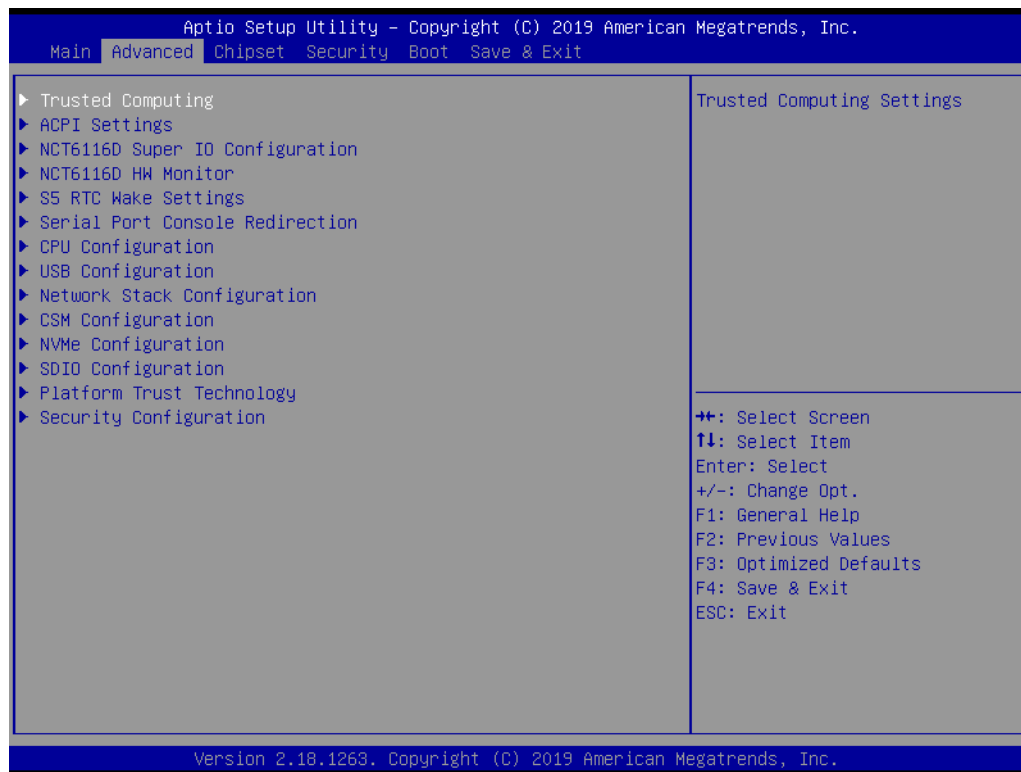

■ Security Device Support

Enable or disable BIOS support for security device

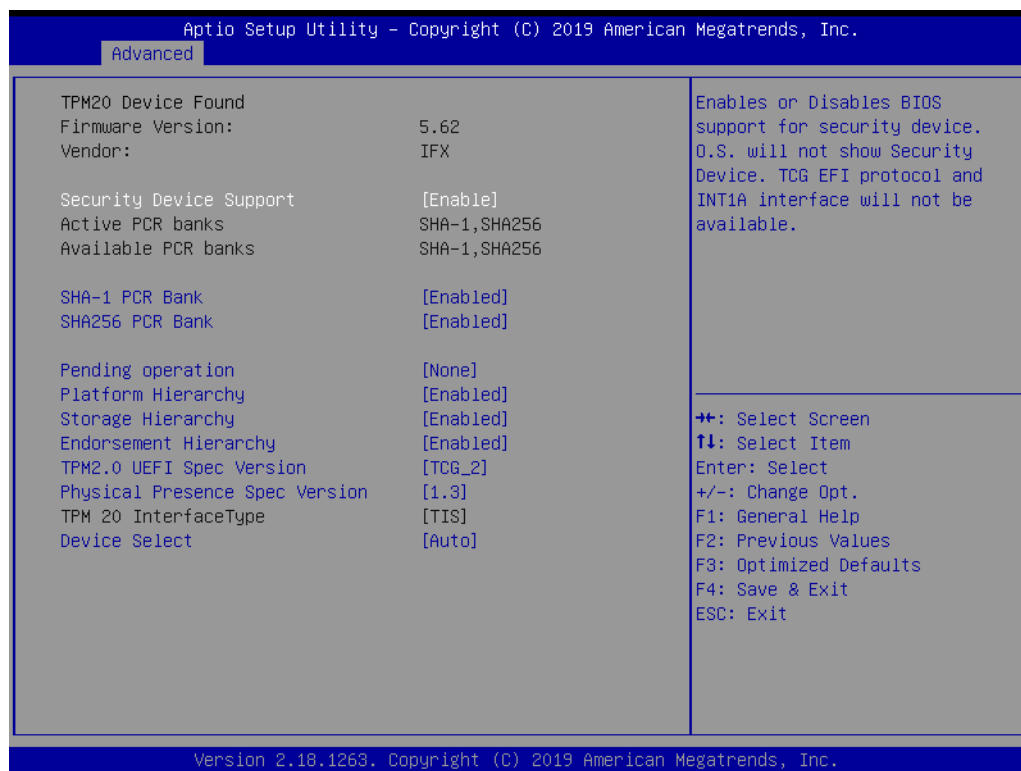

3.2.1.2 ACPI Settings

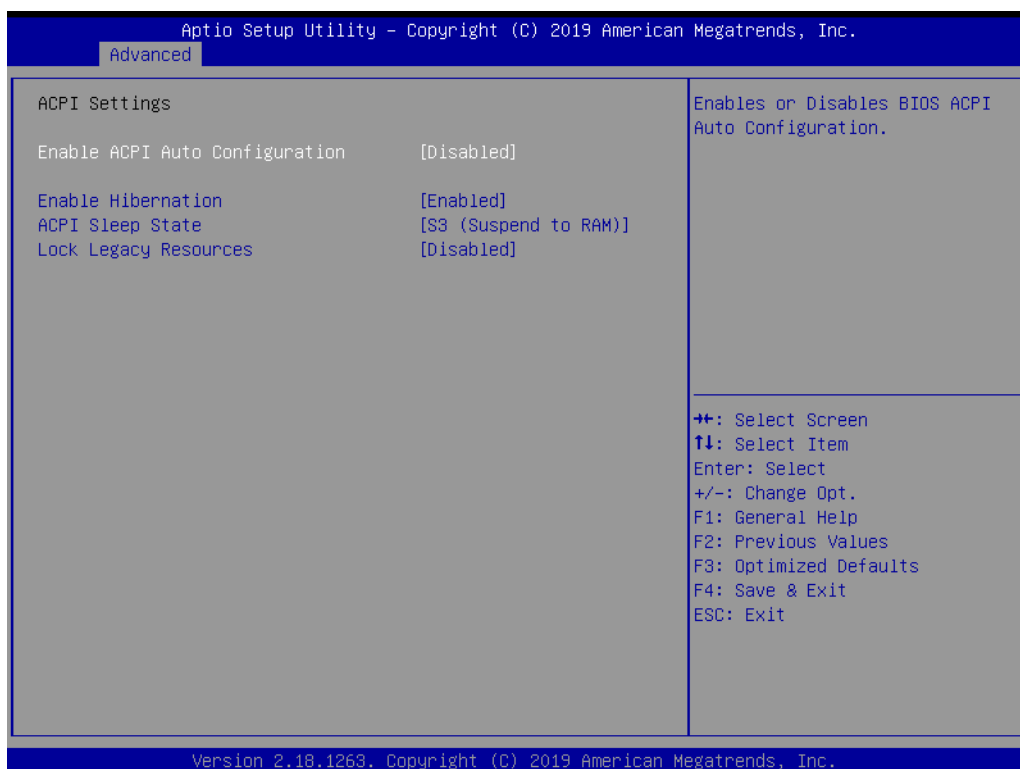
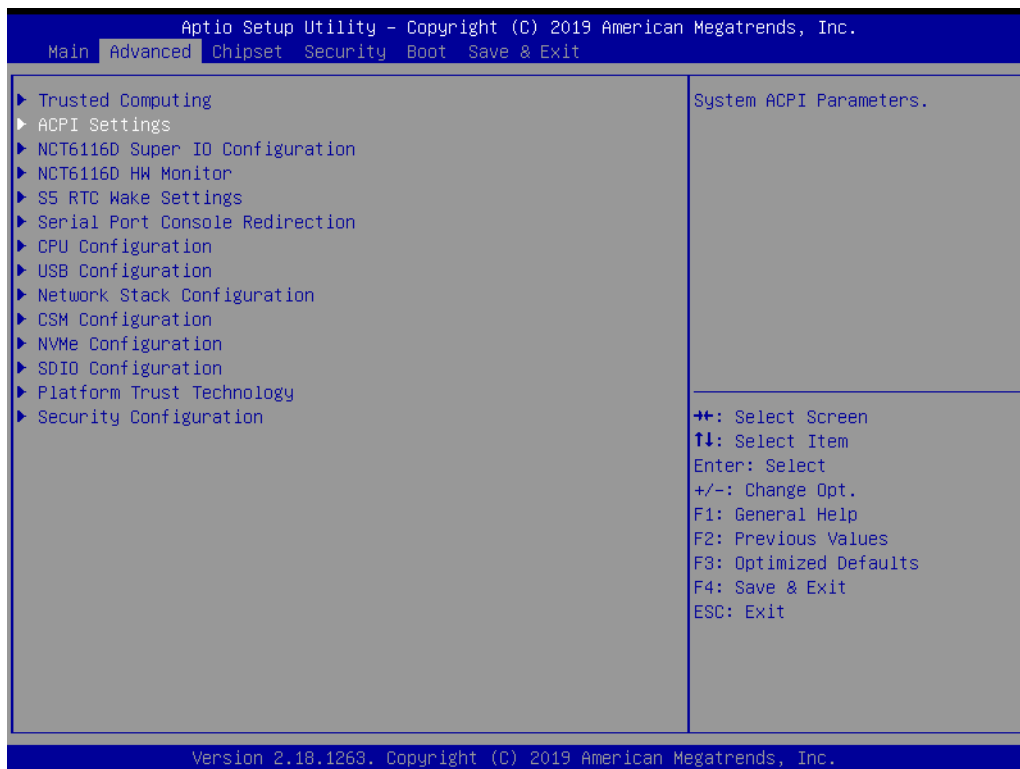

- **Enable ACPI Auto Configuration**
Enable or Disable ACPI Auto Configuration
- **Enable Hibernation**
This item allows users to enable or disable hibernation

- **ACPI Sleep State**
This item allows users to set the ACPI sleep state
- **Lock Legacy Resources**
This item allows users to lock legacy device resources

3.2.1.3 Super I/O Configuration

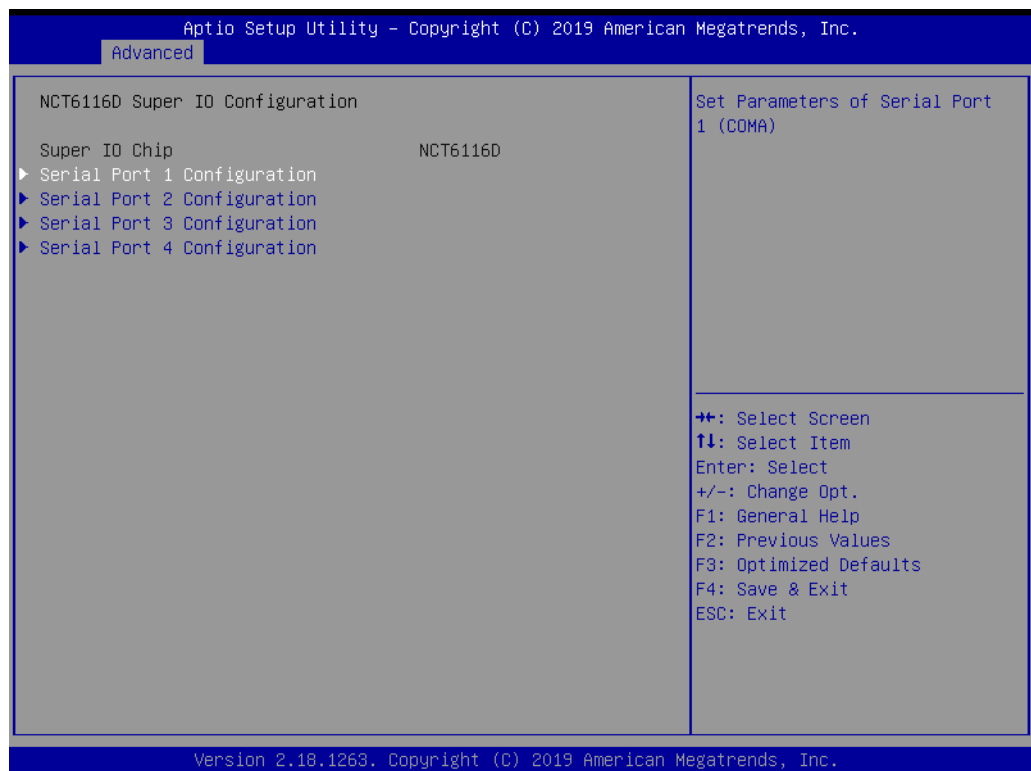
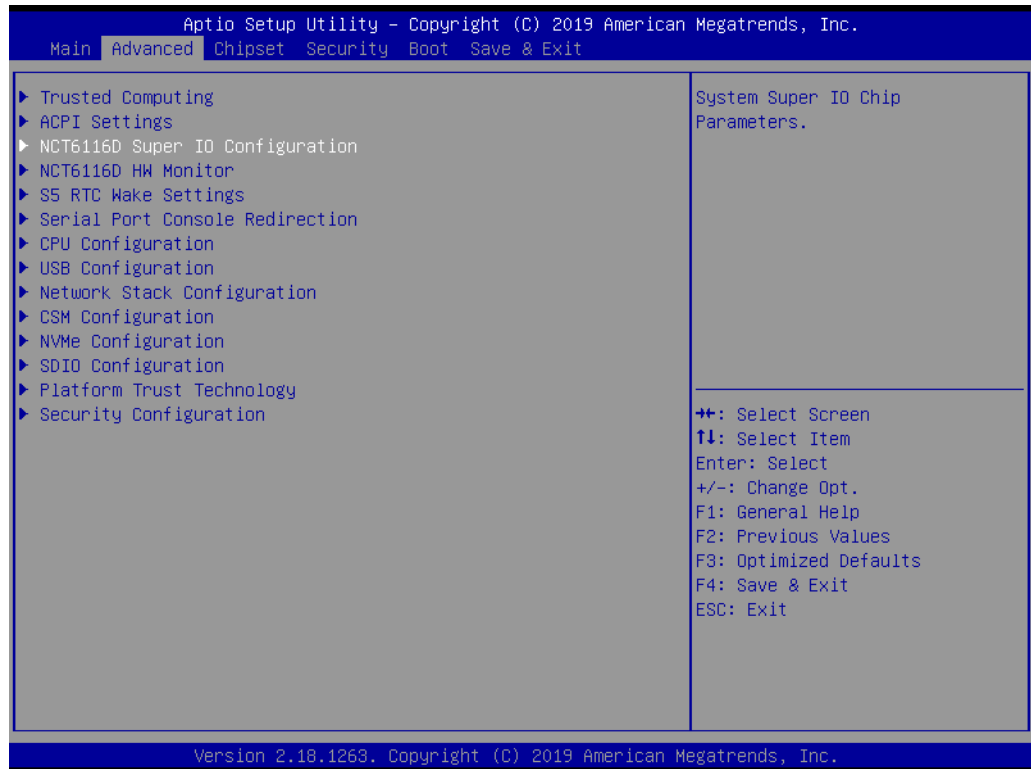

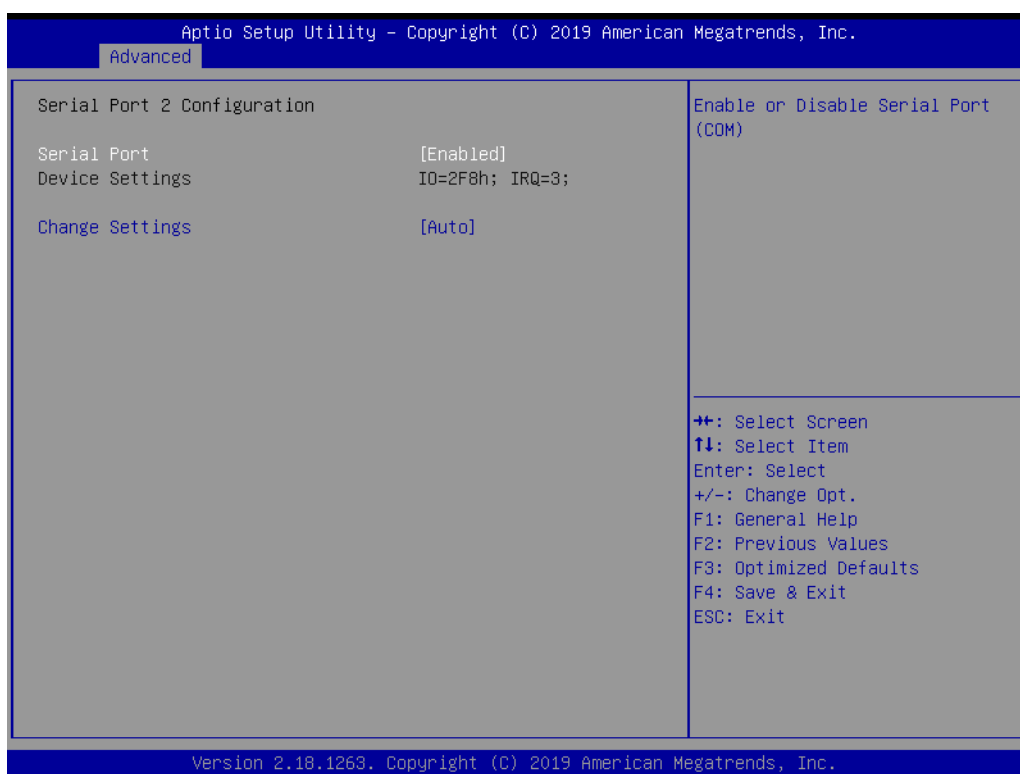
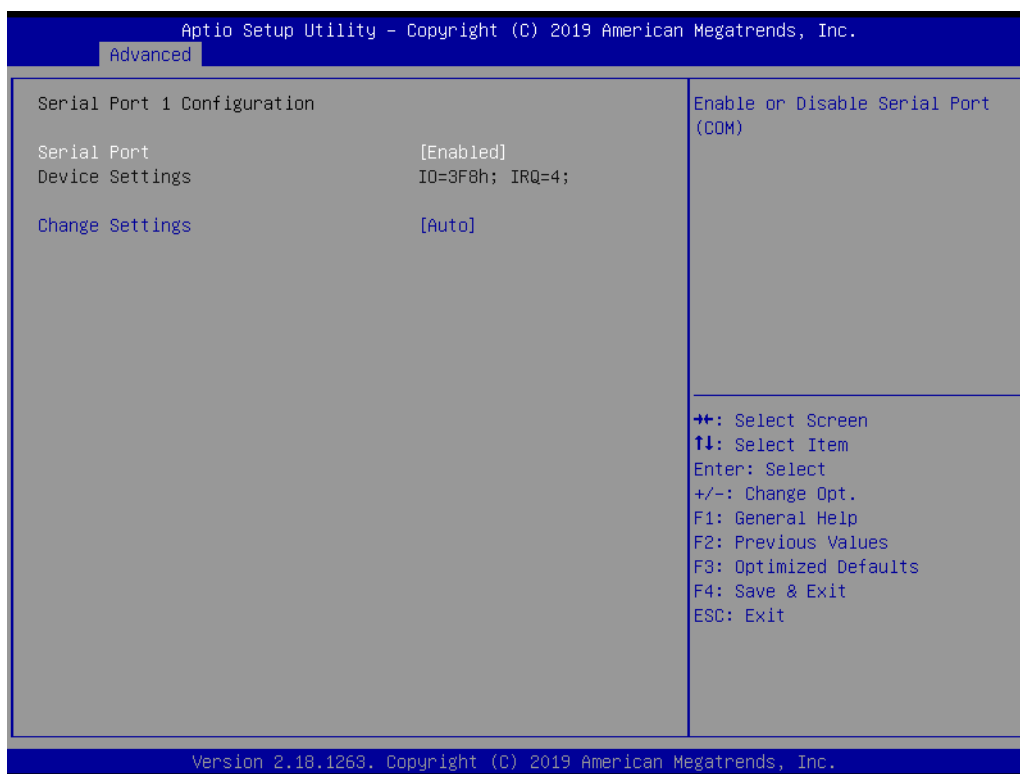

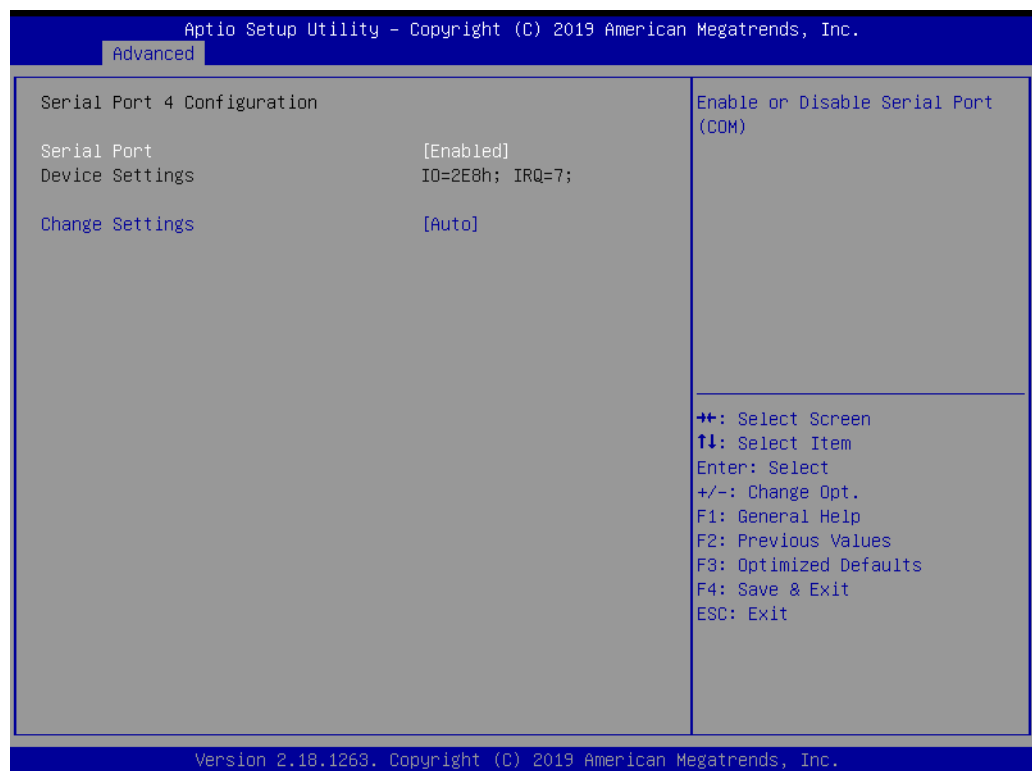
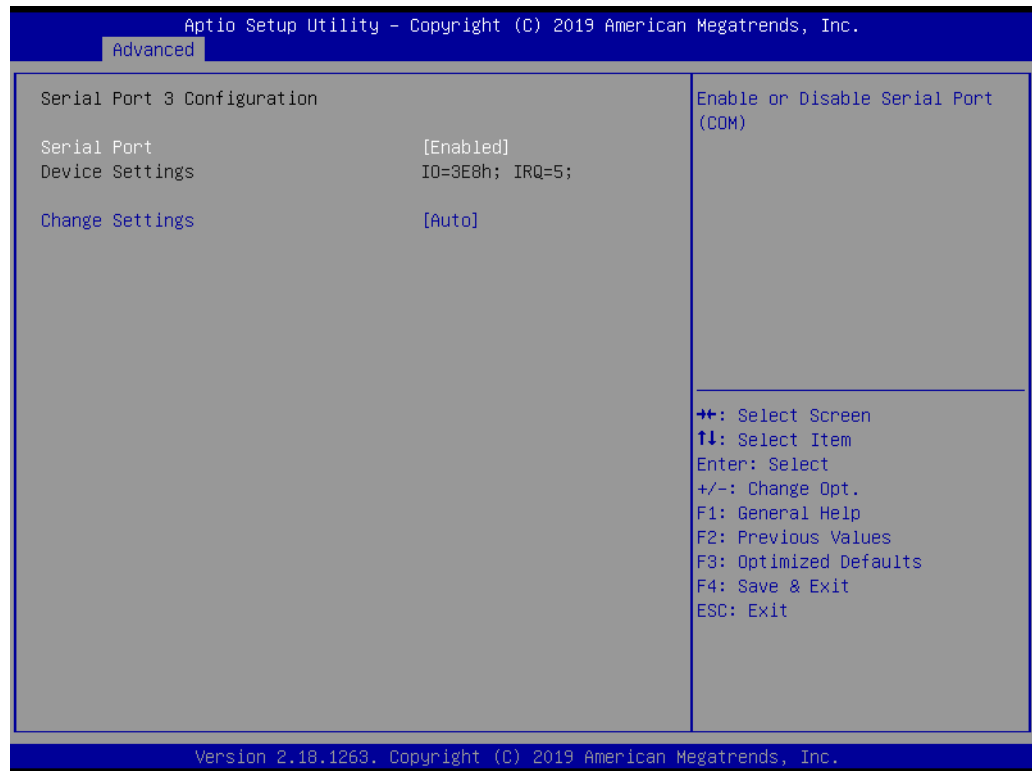

- **Serial Ports 1/2/3/4**
This item allows users to enable or disable serial ports 1/2/3/4
- **Change Settings**
This item allows users to change the serial port 1/2/3/4 setting

3.2.1.4 Hardware Monitor

This page shows the AIMB-U217 PC health status

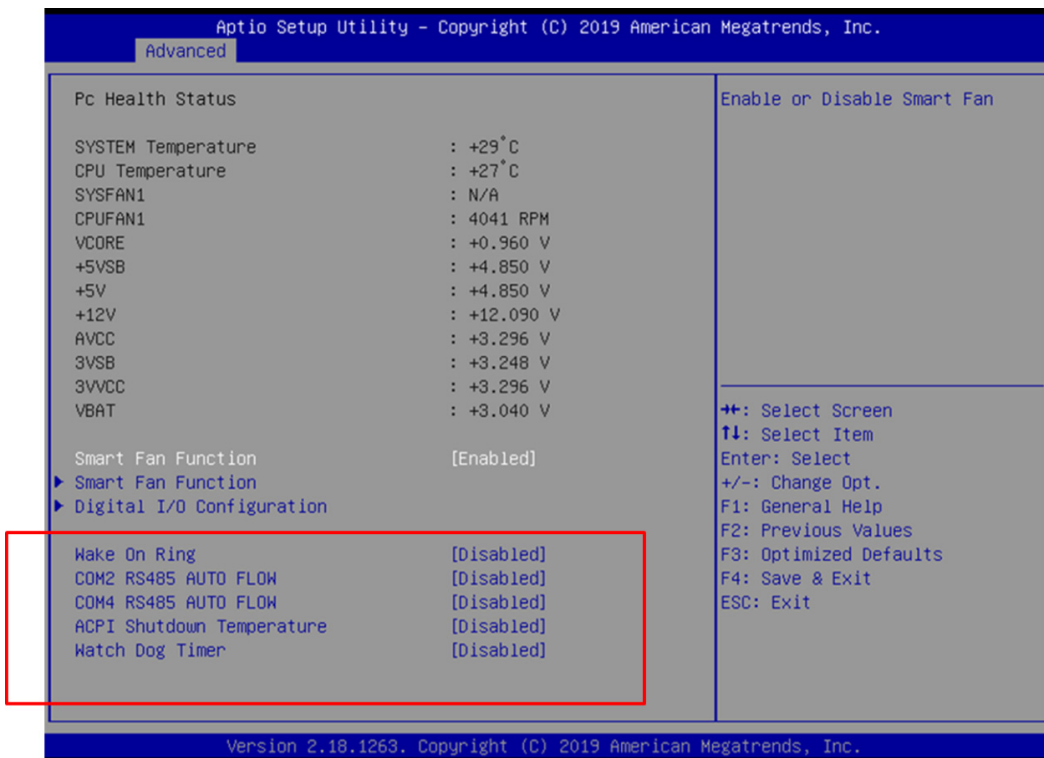
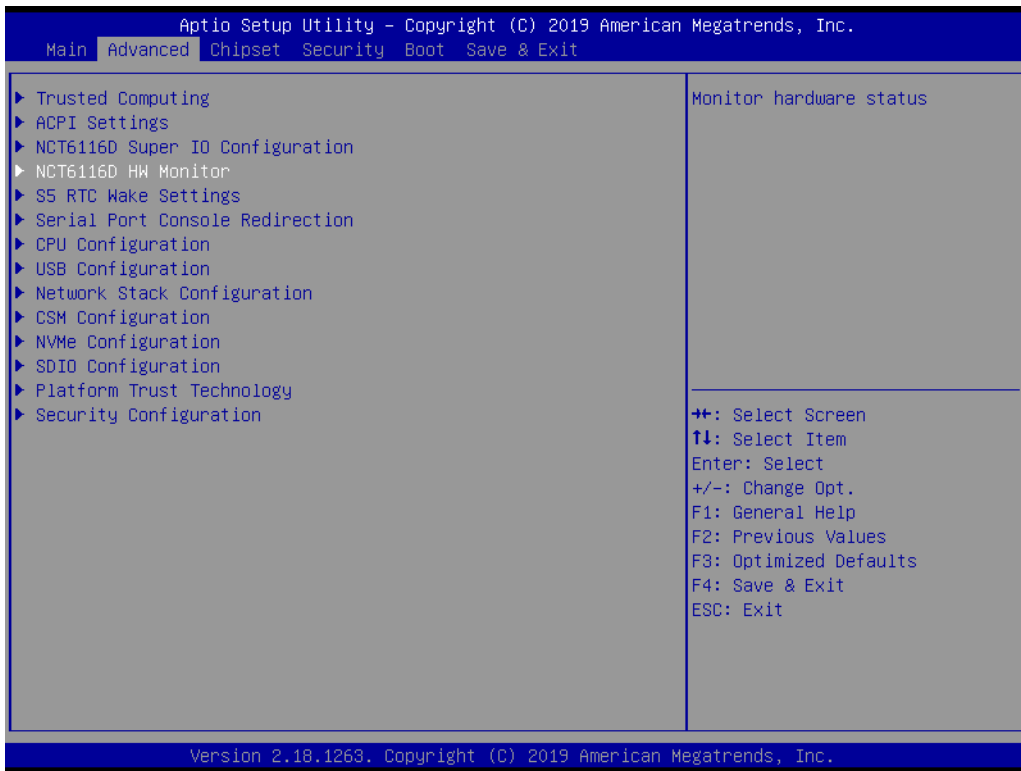

- **Wake On Ring**
This item allows users to enable or disable Wake On Ring functionality
- **RS-485 AUTO FLOW**
This item allows users to enable or disable the RS-485 AUTO FLOW function

- **ACPI Shutdown Temperature**
This item allows users to set the CPU temperature threshold at which the system automatically shuts down to prevent the CPU from overheating
- **Watchdog Timer**
This item allows users to enable or disable the Watchdog timer

3.2.1.5 Digital I/O Configuration

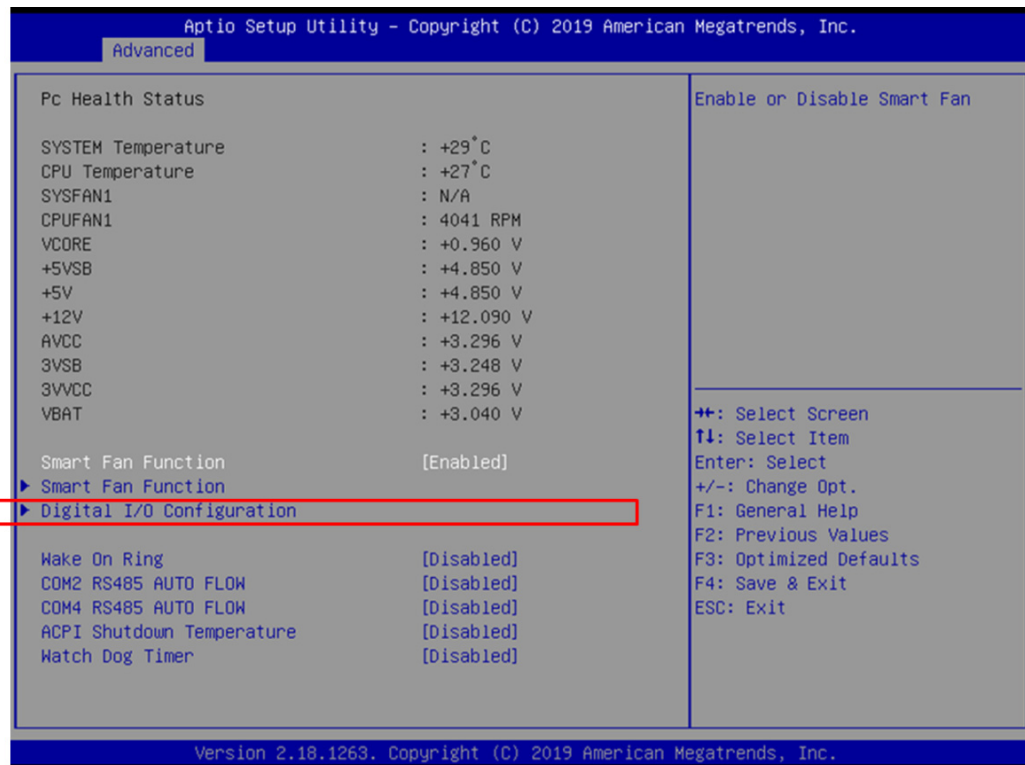

■ Digital I/O Configuration

This item will allow users to set up Digital I/O 1~16 to "input" or "output"

3.2.1.6 Smart Settings

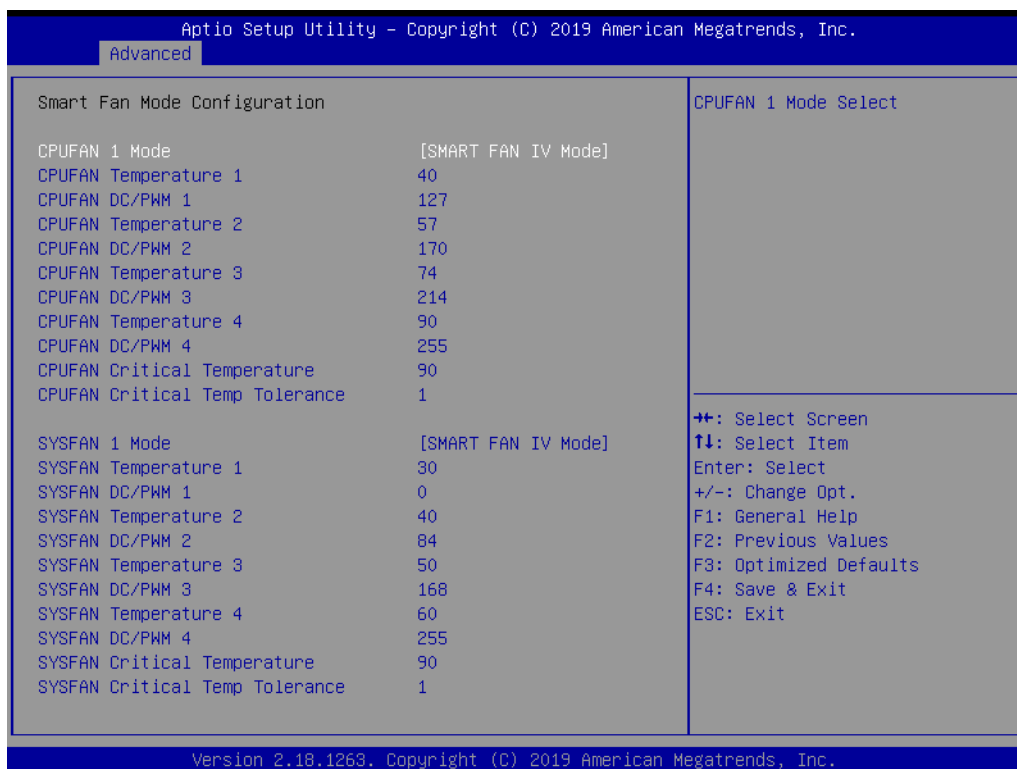
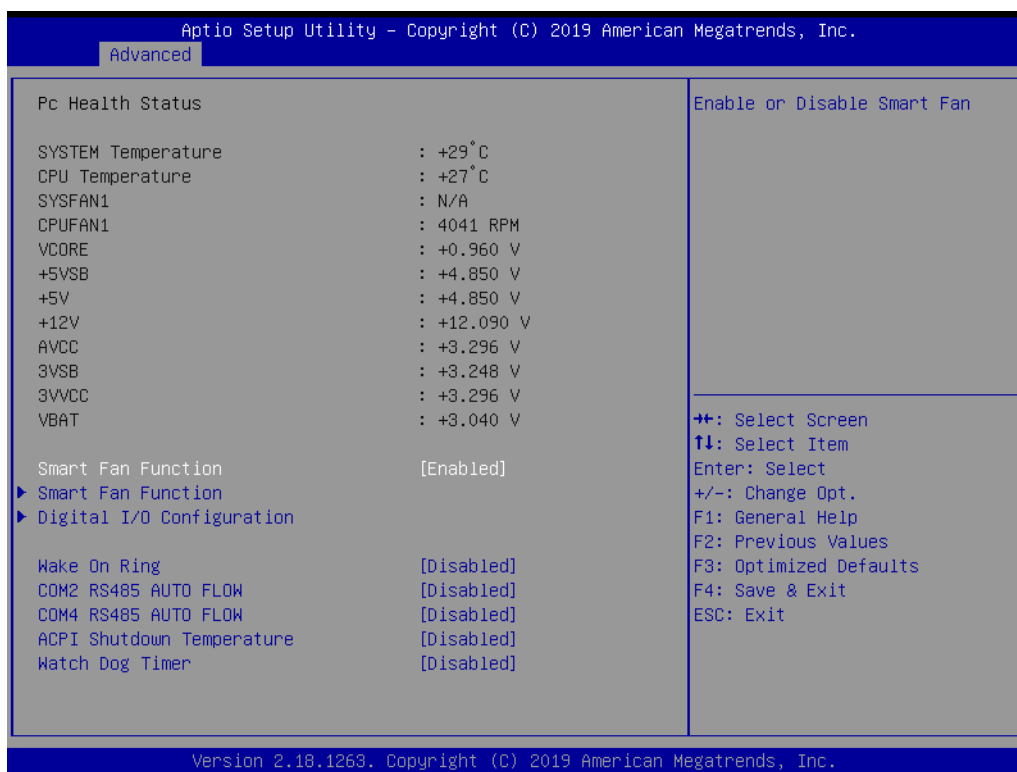

■ Smart Fan Settings

The users are allowed to Enable/Disable smart fan

The users are allowed to configure smart fan

3.2.1.7 S5 RTC Wake Settings

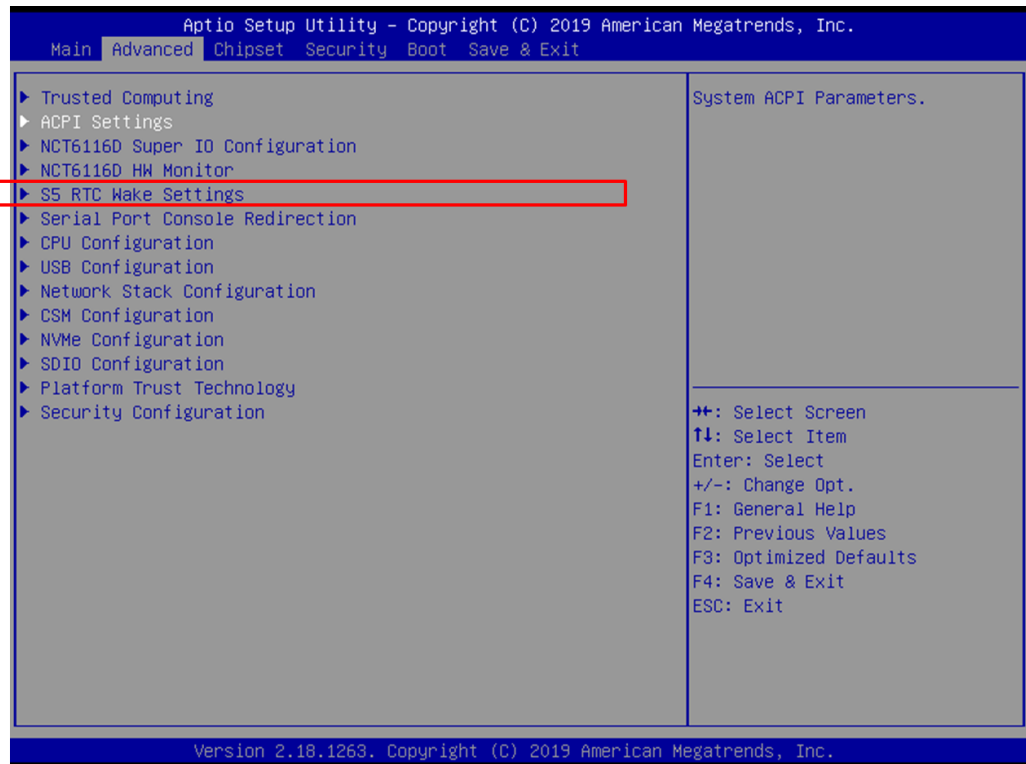

- **Wake System From S5**
Enable or disable system wake on alarm event

3.2.1.8 Serial Port Console Redirection

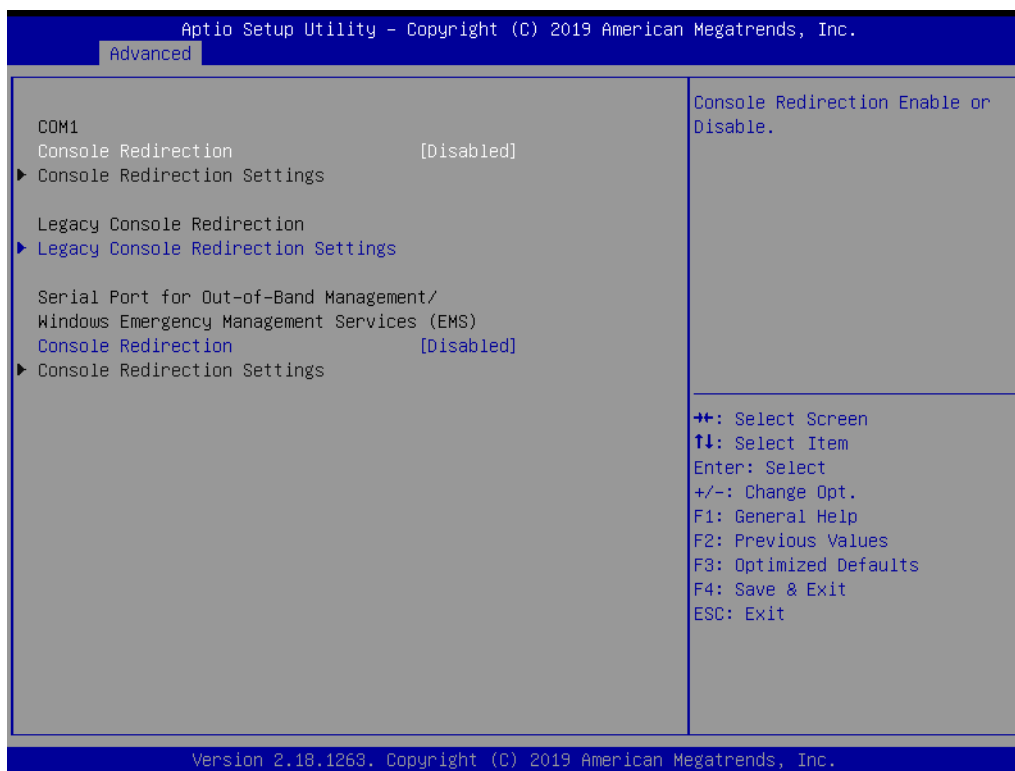
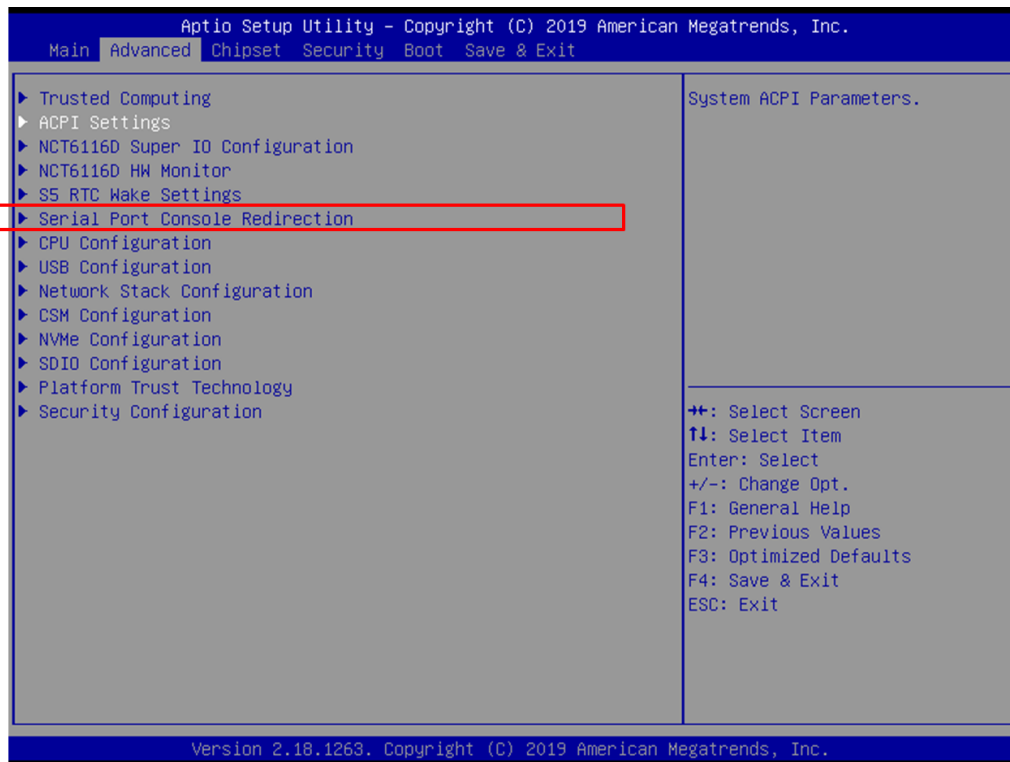

■ Console Redirection

This item allows users to enable or disable console redirection

3.2.1.9 CPU Configuration

This page shows CPU Information.

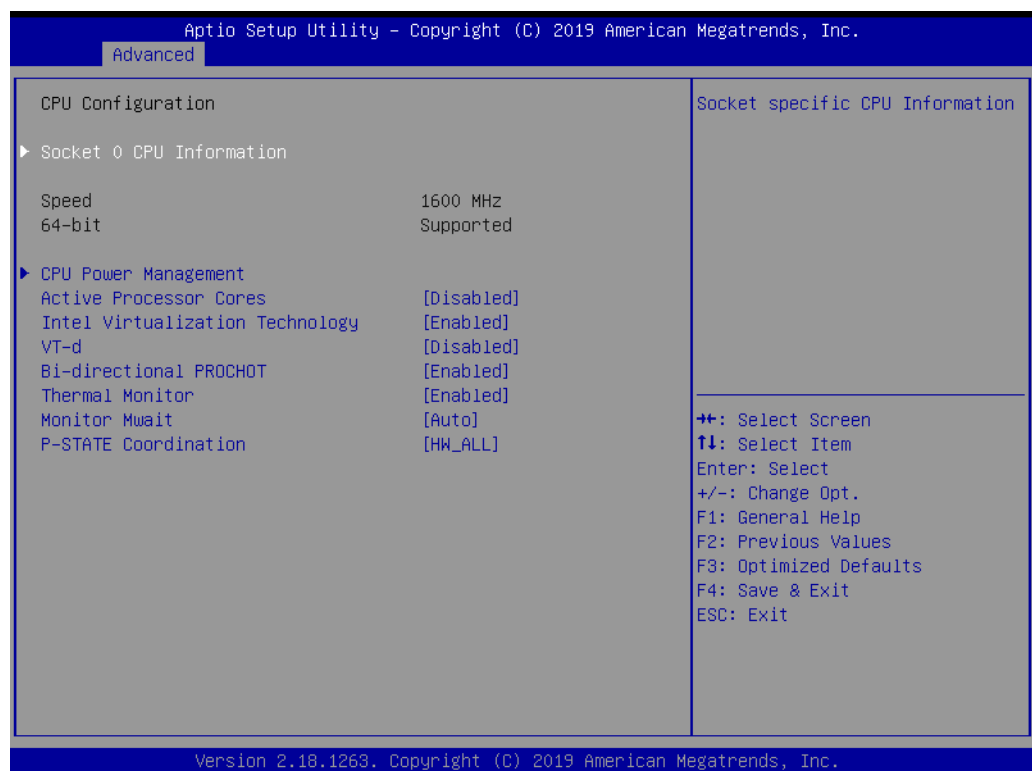
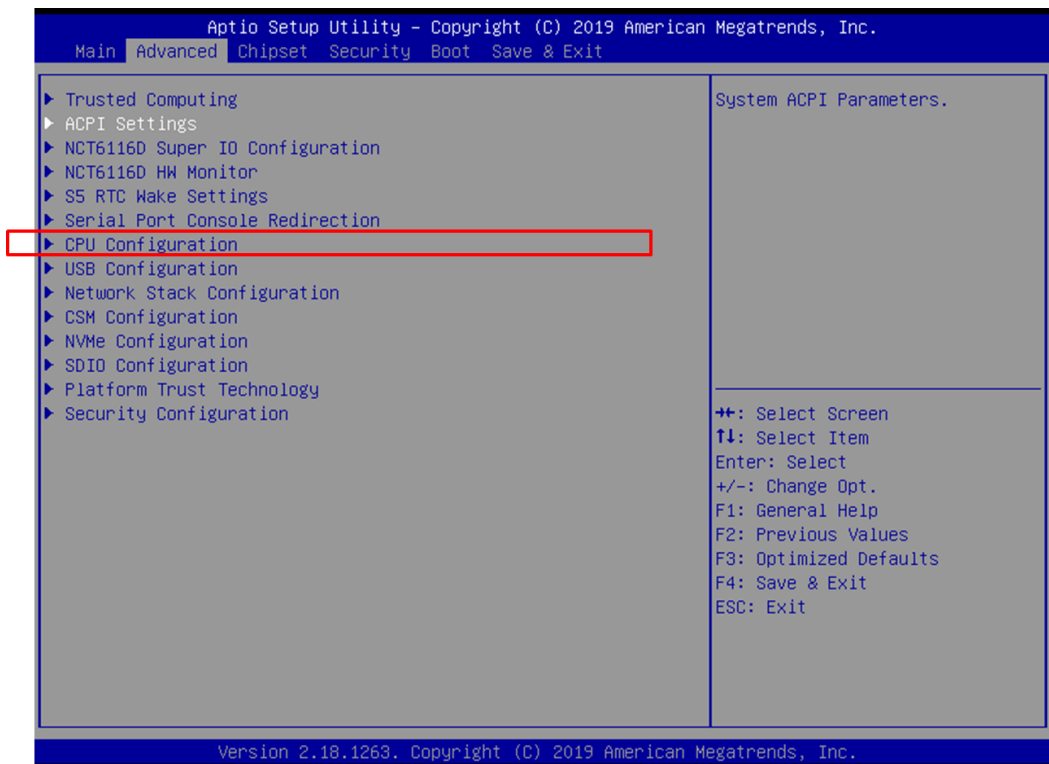

- **Active Power Cores**
Number of cores to enable in each processor package
- **Intel Virtualization Technology**

When enabled, a VMM can utilize the additional hardware capabilities provided by Vanderpool Technology.

- **VT-d**
Enable or disable VT-d
- **Bi-Directional PROCHOT**
When a processor thermal sensor trips (either core), the PROCHOT# will be driven. If bi-direction is enabled, external agents can drive PROCHOT# to throttle the processor
- **Thermal Monitor**
Enable or disable Thermal Monitor
- **Monitor Mwait**
Enable/disable Monitor Mwait
- **P-STATE Coordination**
Change P-STATE Coordination type

CPU Power Management Configuration

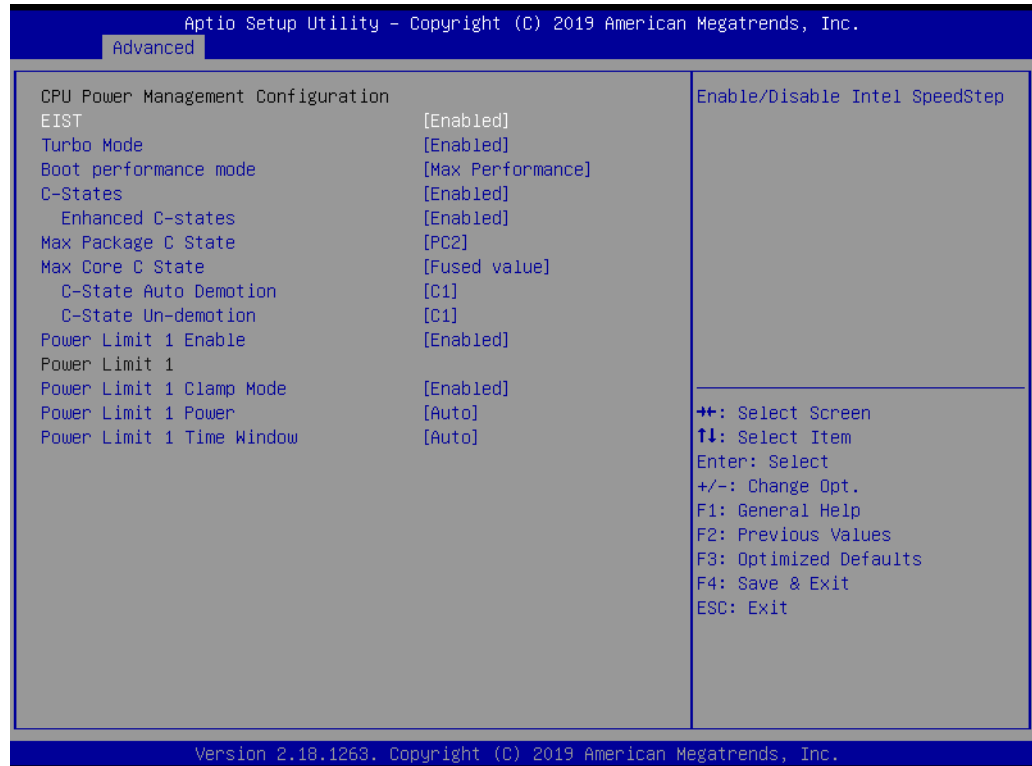

- **EIST**
Enabled or disabled Intel Speed Step function
- **Turbo Mode**
Enabled or disabled Turbo Mode
- **Boot Performance Mode**
Select the performance state that the BIOS will set before OS handoff
- **C-States**
Enabled or disabled C-States
- **Enhanced C-States**
Enabled or disabled C1E. When enabled, CPU will switch to minimum speed when all cores enter C-State
- **Max Package C State**
Controls the max package C state that the processor will support
- **Max Core C State**
This option controls the Max Core C State that cores will support
- **C-State Auto Demotion**
Configure C-State Auto Demotion
- **C-State Un-Demotion**
Configure C-State Un-demotion
- **Power Limit 1 Enable**
Enable/Disable Power Limit 1
- **Power Limit 1 Clamp Mode**
Enable/Disable Power Limit 1 Clamp Mode
- **Power Limit 1 Power**
Power Limit 1 in Watts. Auto will program Power Limit 1 based on silicon default support value

- **Power Limit 1 Time Window**

Power Limit 1 Time Window Value in seconds. Auto will program Power Limit 1 Time Window based on silicon default support value.

3.2.1.10 Network Stack Configuration

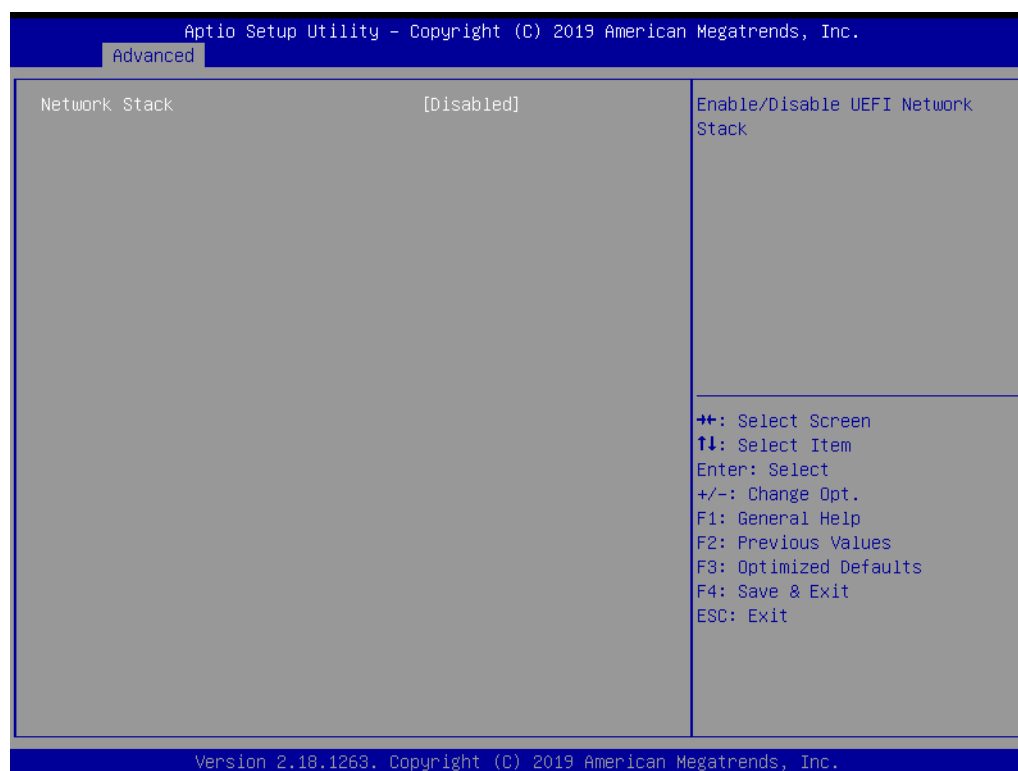
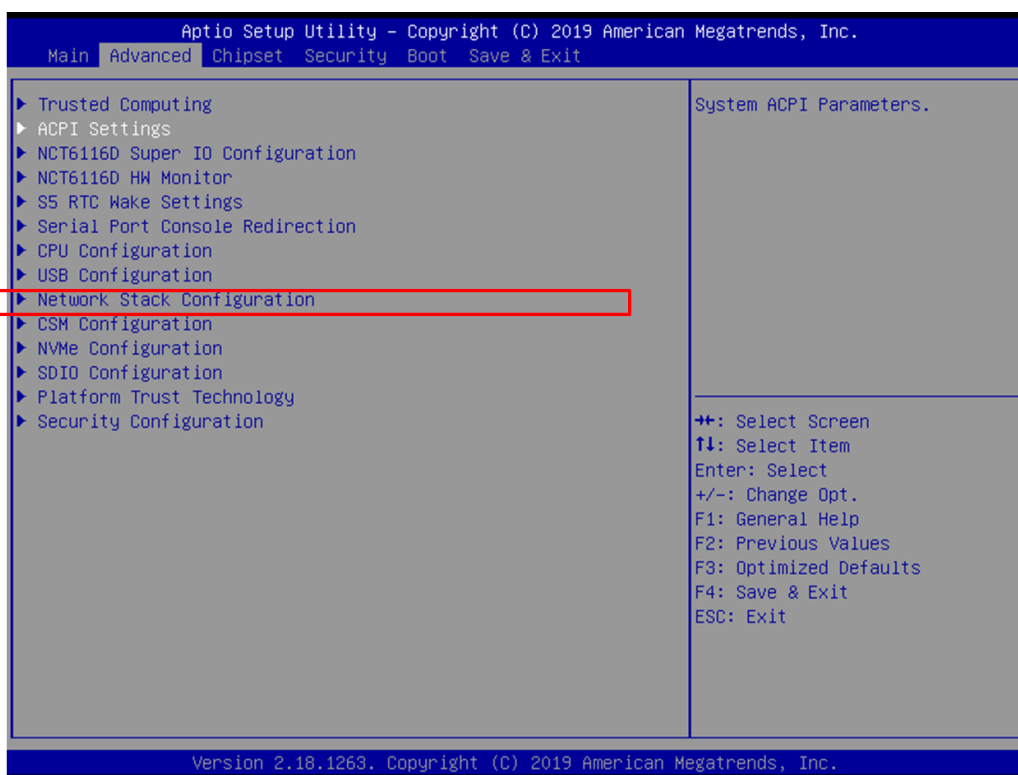

- **Network Stack**

Enable or disable UEFI Network Stack

3.2.1.11 CSM Configuration

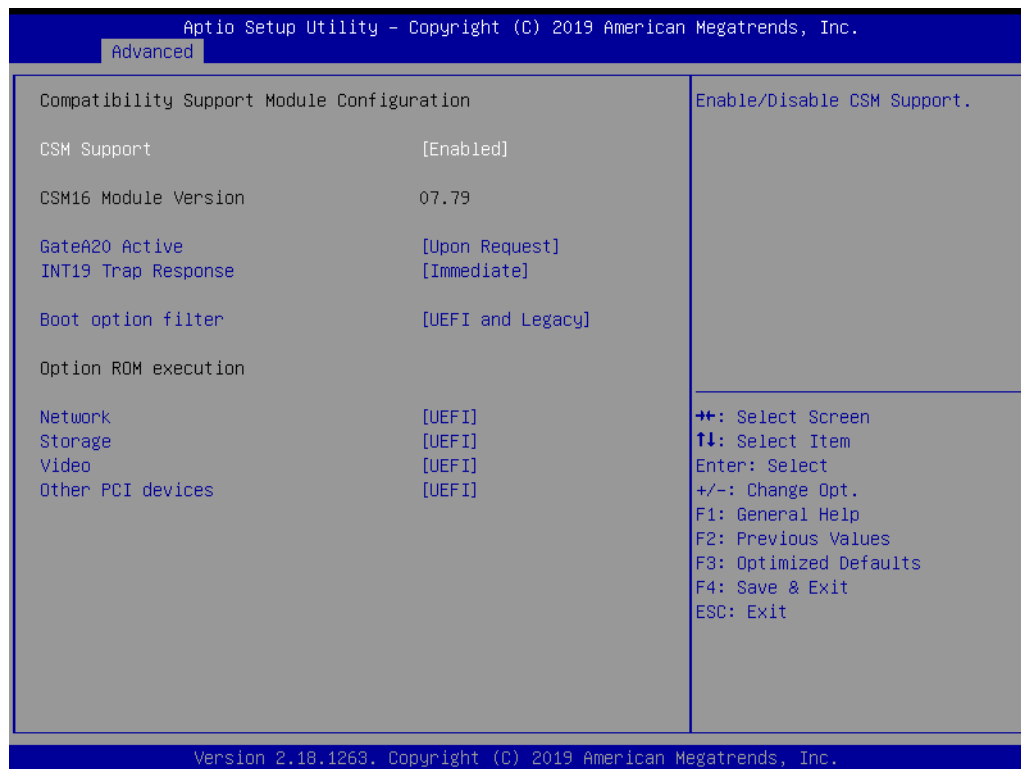
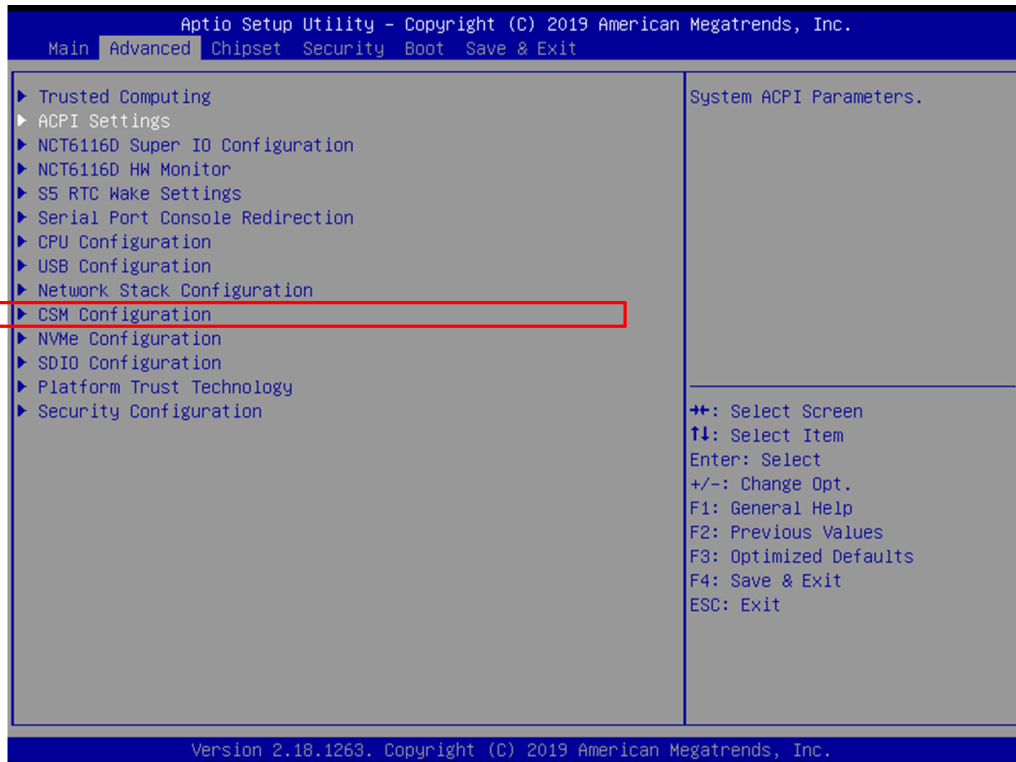

- **CSM Support**
 Enable or disable CSM Support

3.2.1.12 NVMe Configuration

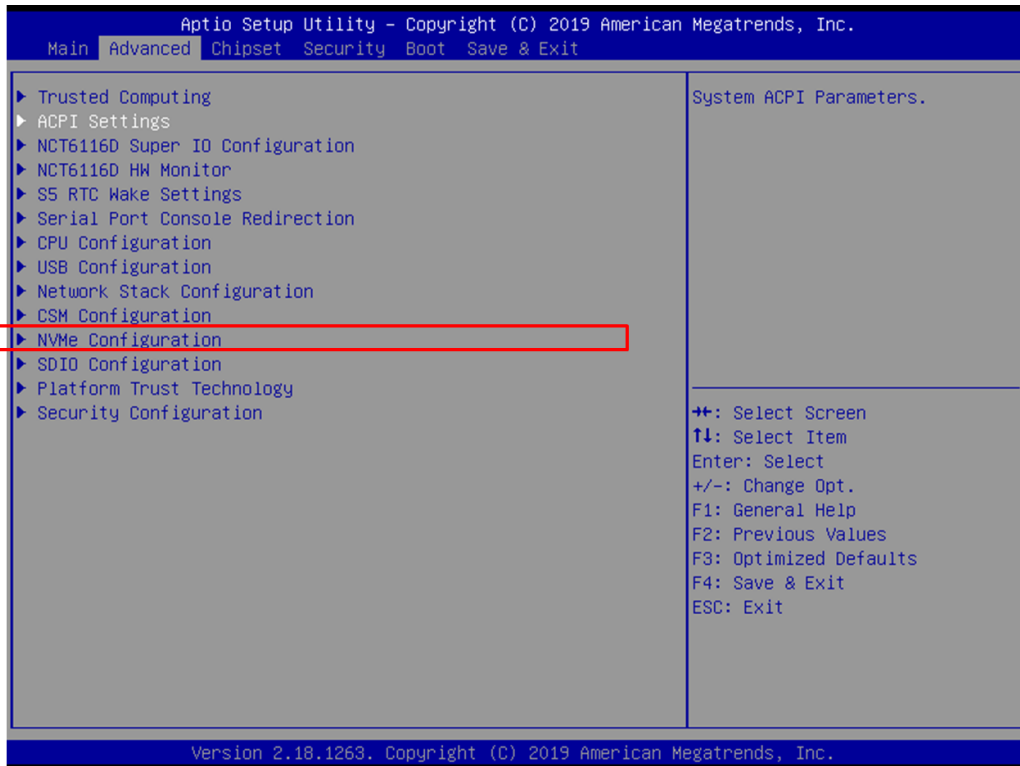

3.2.1.13 SDIO Configuration

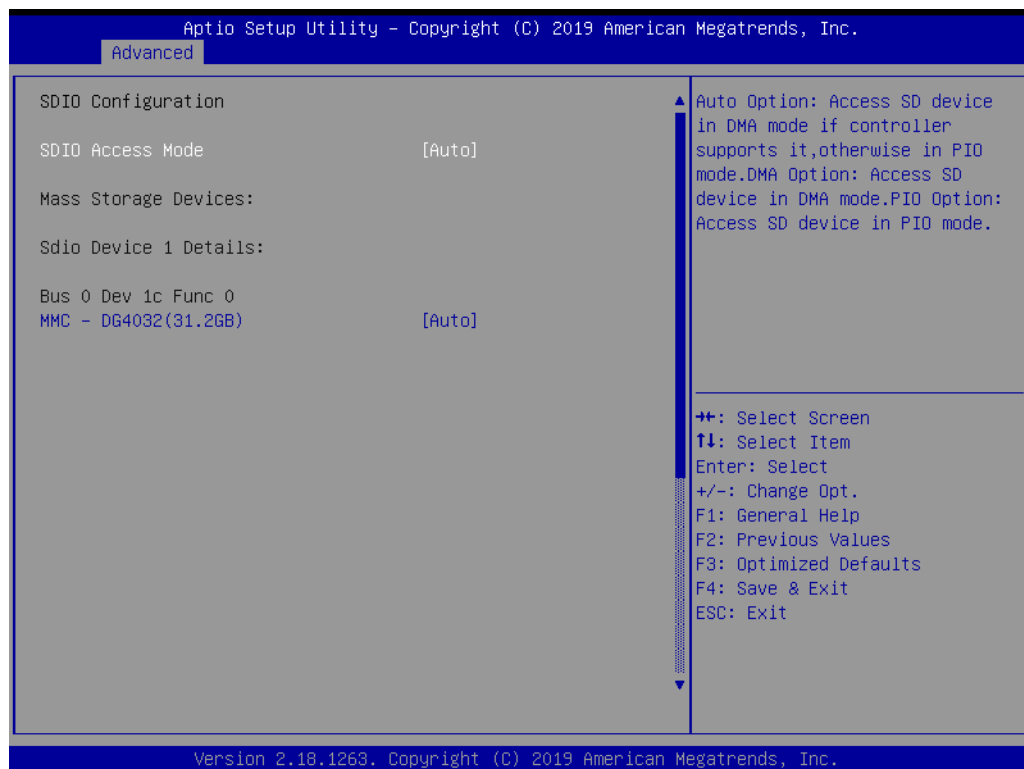
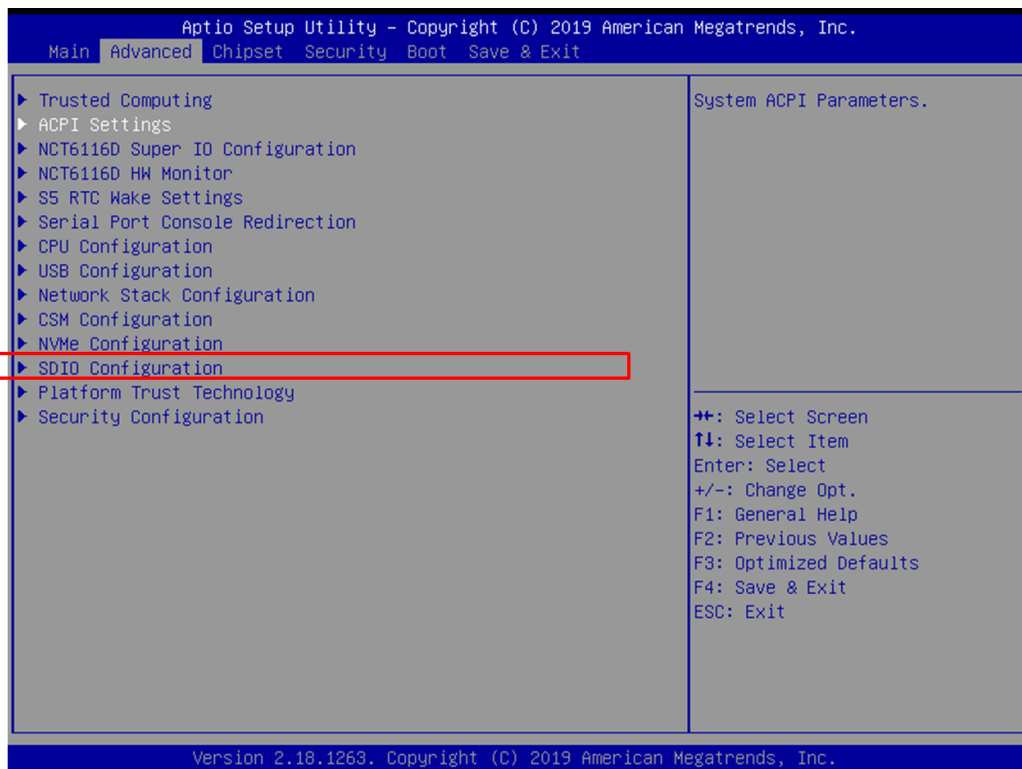

3.2.1.14 USB Configuration

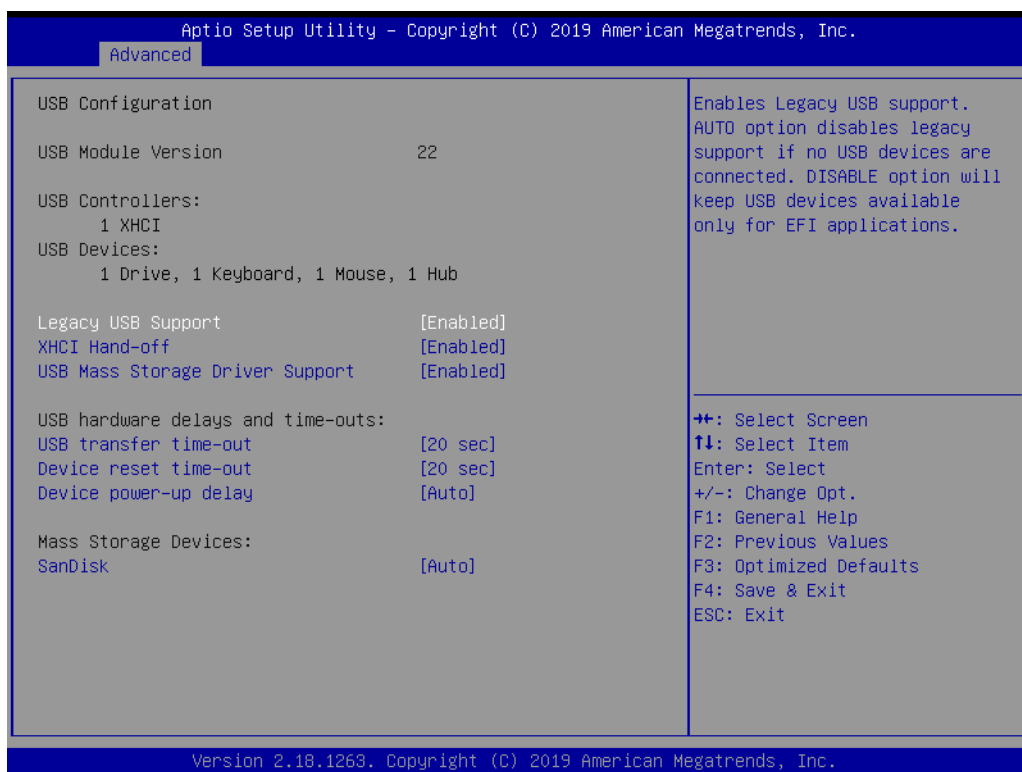
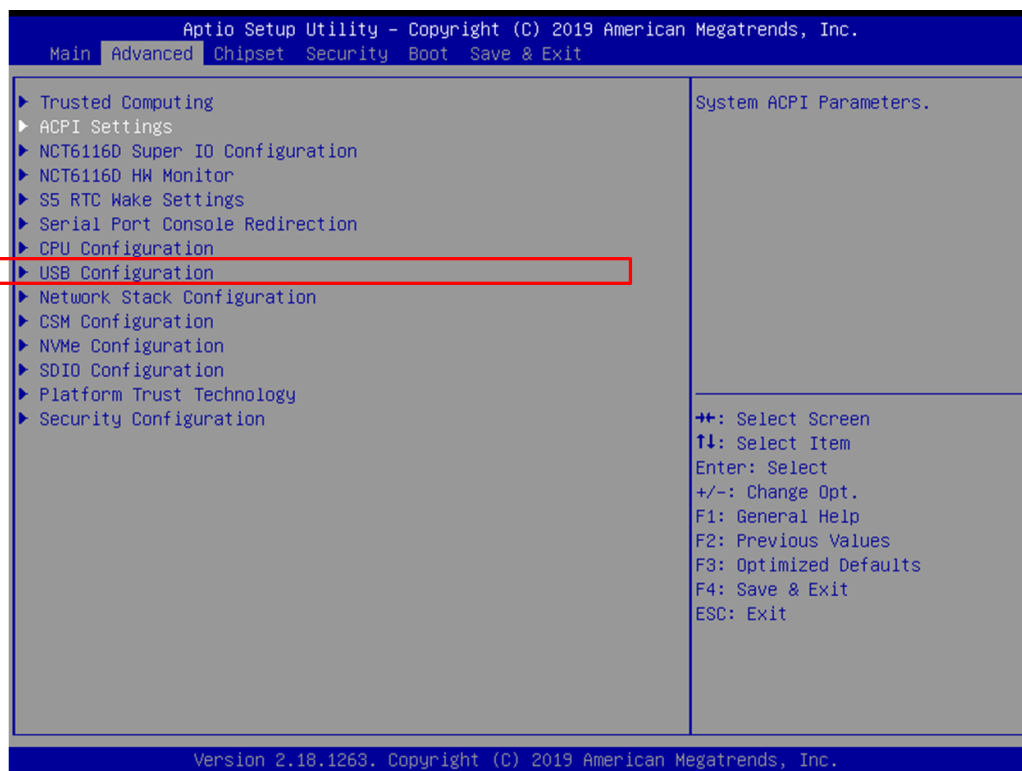

■ Legacy USB Support

Enables support for legacy USB. Auto option disables legacy support if no USB devices are connected. DISABLE option will keep USB devices available only for EFI applications.

- **XHCI Hands Off**
This is a workaround for OSES without XHCI hand-off support. The XHCI ownership change should claim by XHCI driver.
- **USB Mass Storage Driver Support**
This item allows users to enable or disable USB Mass Storage Driver
- **USB Transfer Time-Out**
Time-out value for control, bulk, and interrupt transfers
- **Device Reset Time-Out**
USB mass storage device starts unit command time-out
- **Device Power-Up Delay**
Maximum time the device will take before it properly report itself to the host controller. 'Auto' uses default value: for a Root port it is 100 ms, for a Hub port the delay is taken from Hub descriptor.
- **Mass Storage Device**
Mass storage device emulation type. 'AUTO' enumerates devices according to their media format. Optical drives are emulated as 'CDROM', drives with no media will be emulated according to a drive type.

3.2.1.15 Platform Trust Technology

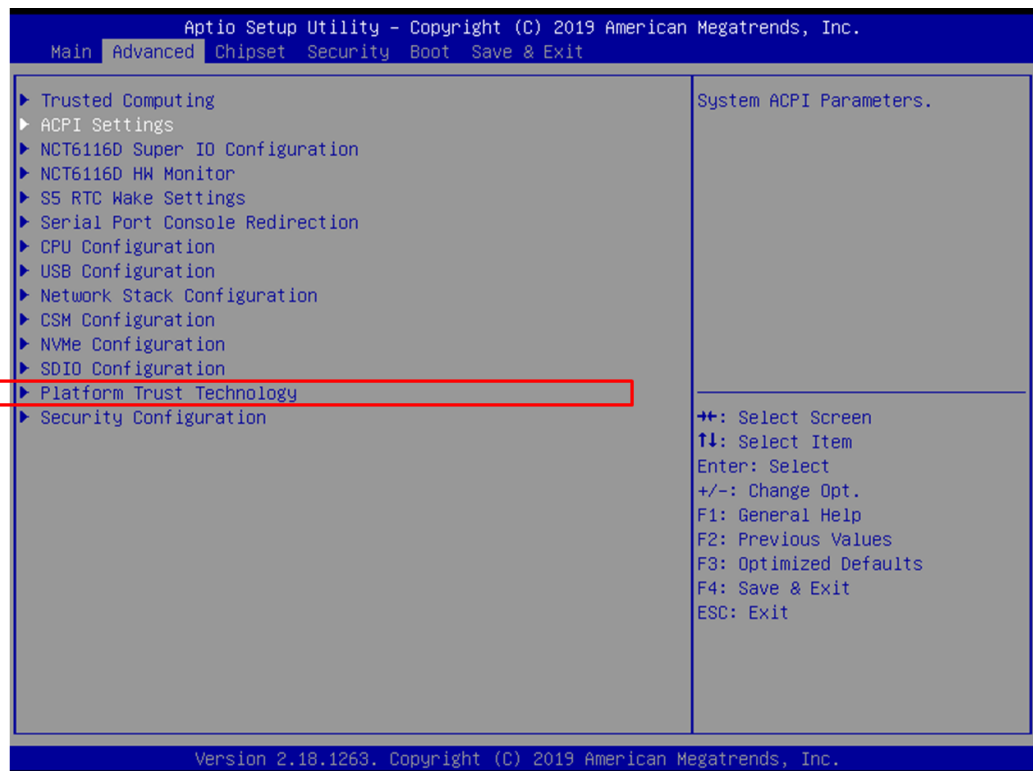

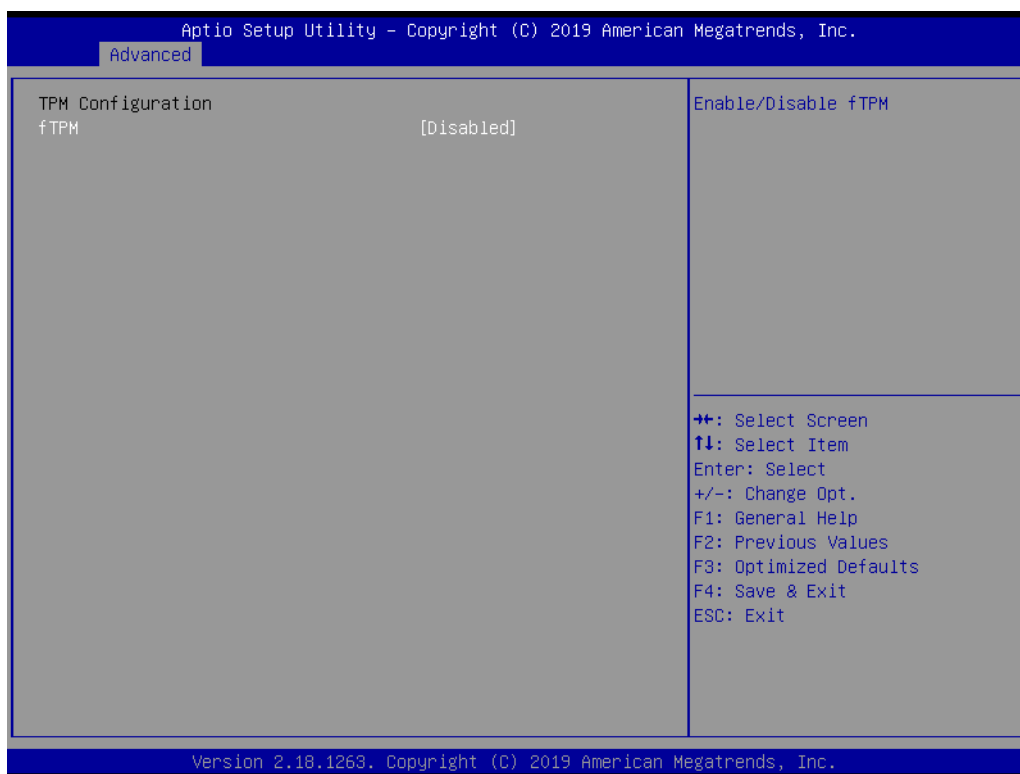

- **fTPM**
Enabled or disabled fTPM

3.2.1.16 Security Configuration

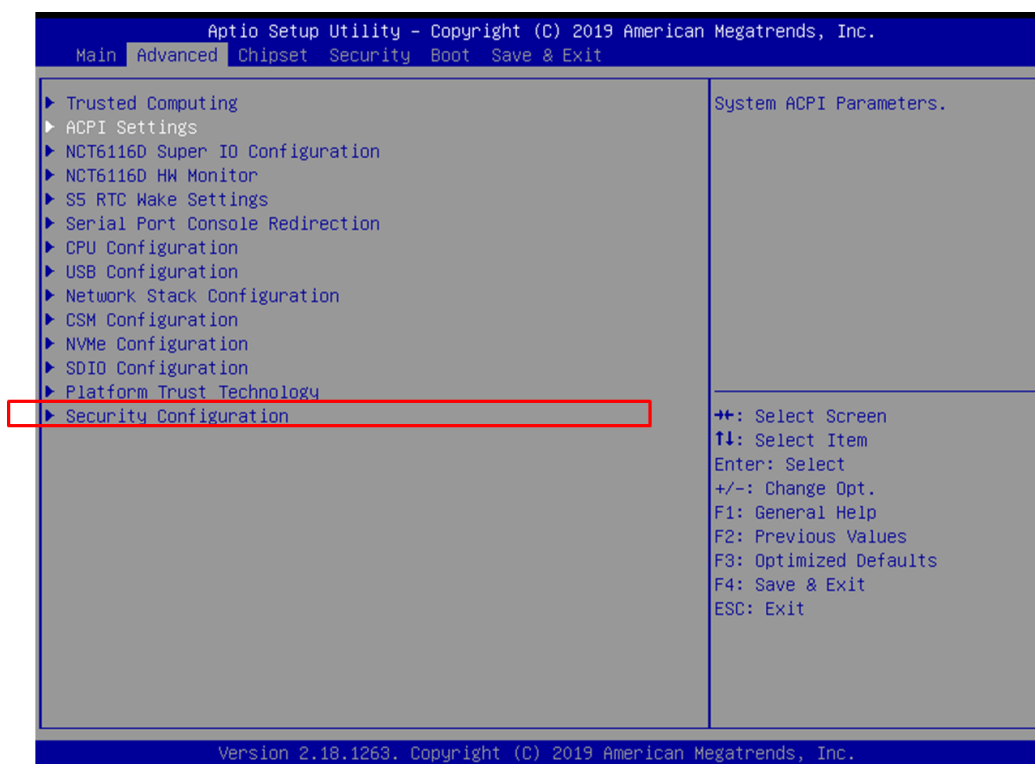

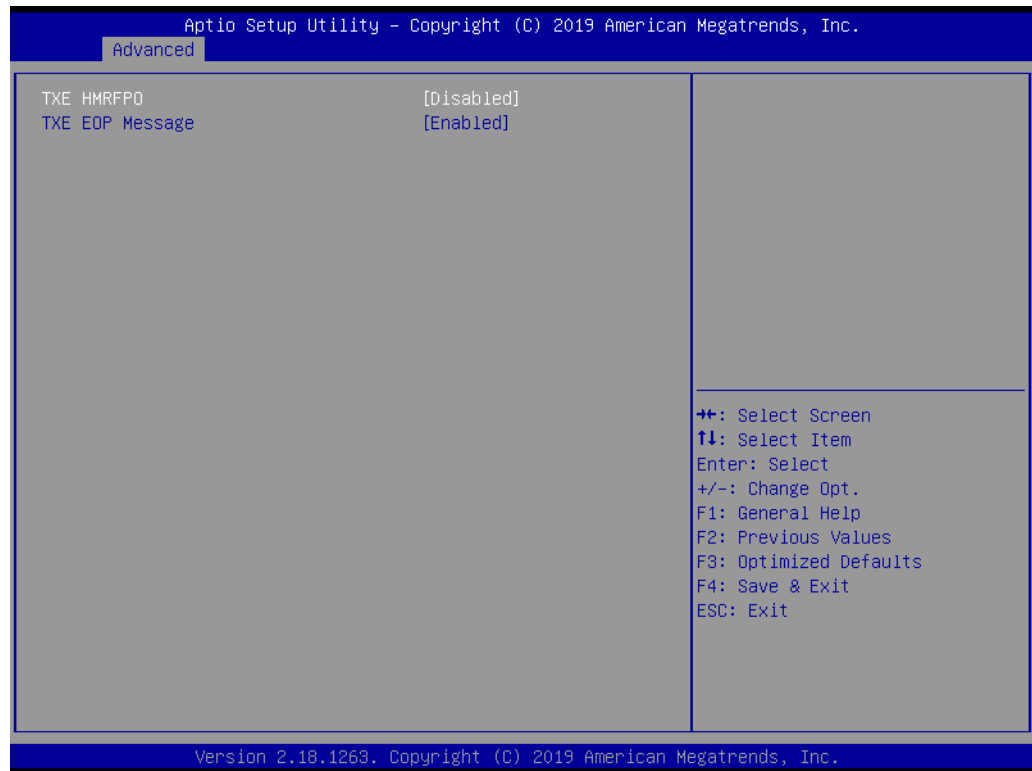

- **TXE HMRFP0**
This item allows users to enable or disable TXE HMRFP0
- **TXE EOP Message**
Send EOP Message before Enter OS

3.2.2 Chipset

This page provides information of the chipset on AIMB-U217

3.2.2.1 North Bridge

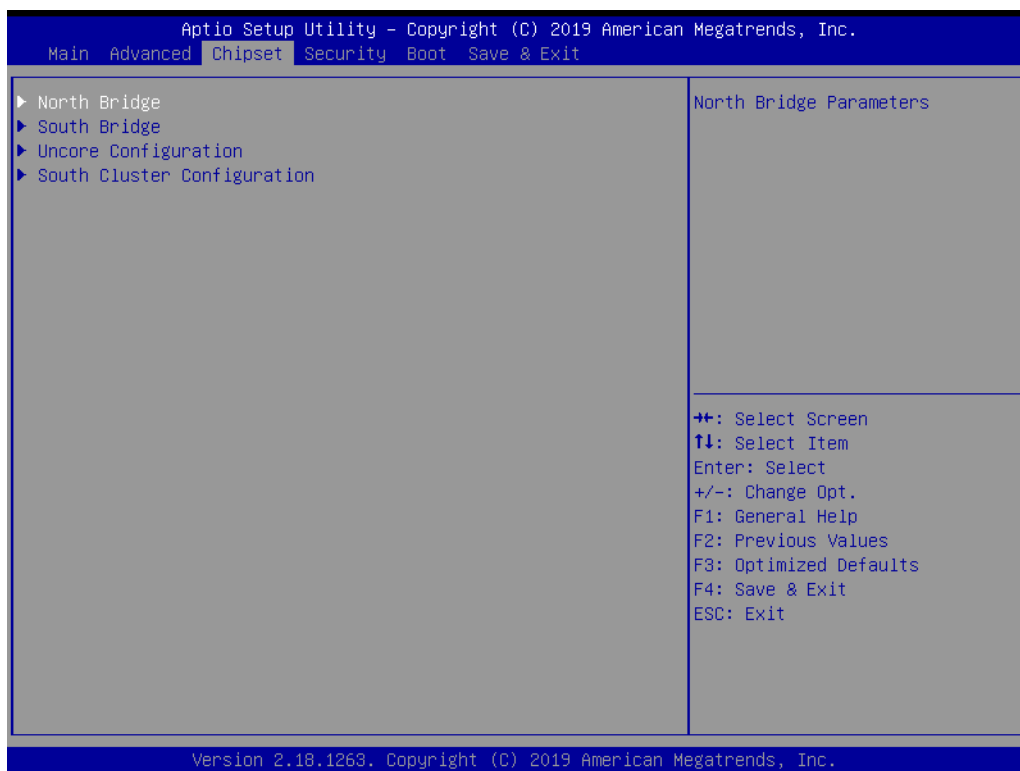

- **LCD Control**
LVDS panel type selection / Brightness PWM Output settings

- **Max TOLUD**
This item allows users to select the maximum value of TOLUD
- **Above 4GB MMIO BIOS assignment**
"Enable" to allow Memory-mapped IO BIOS assignment to go above 4GB
- **PCIE VGA Workaround**
Enable it if your PCIe card cannot boot to DOS. This is for Test only

3.2.2.2 South Bridge

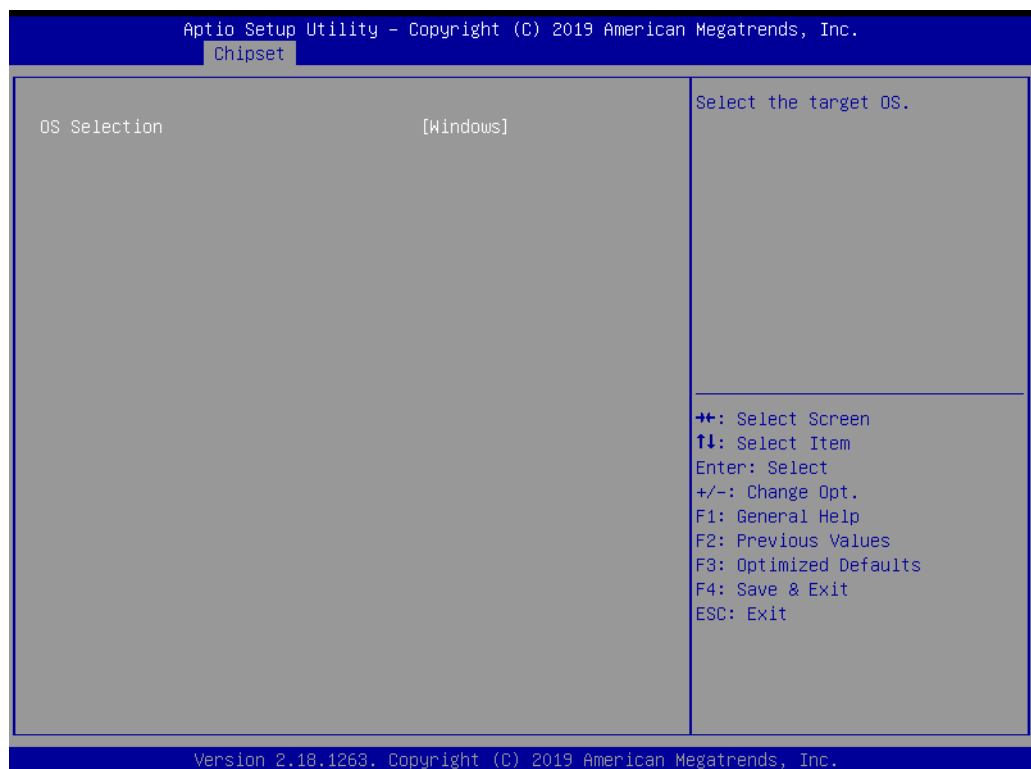
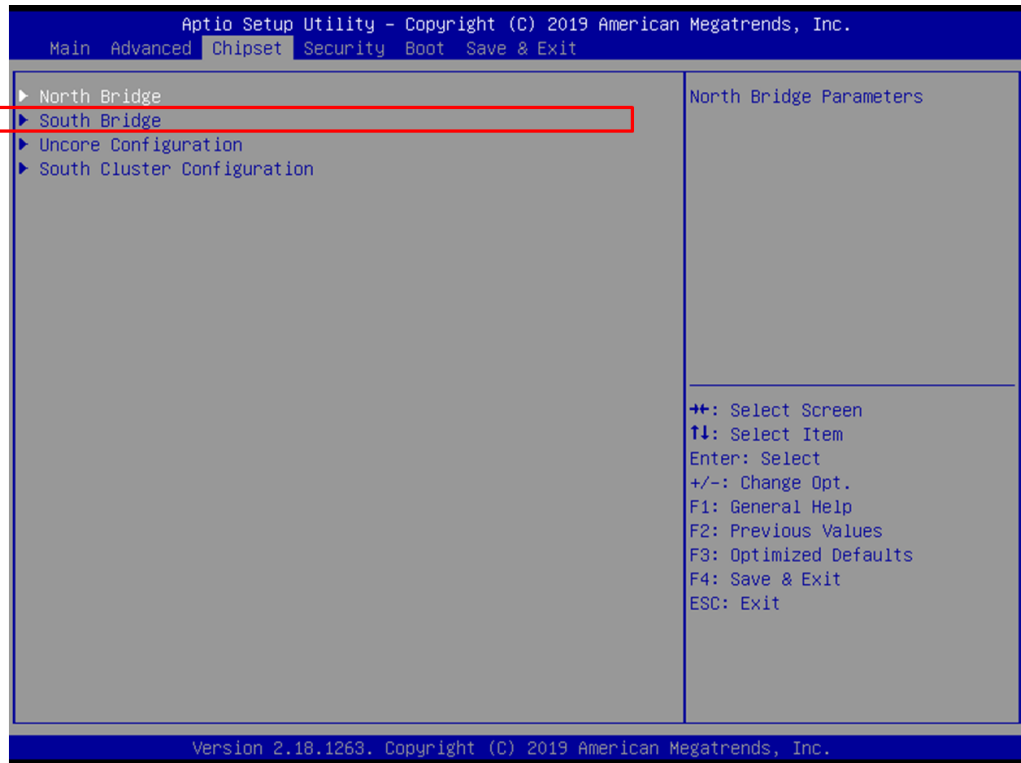

- **OS Selection**
Select the target OS

3.2.2.3 Uncore Configuration

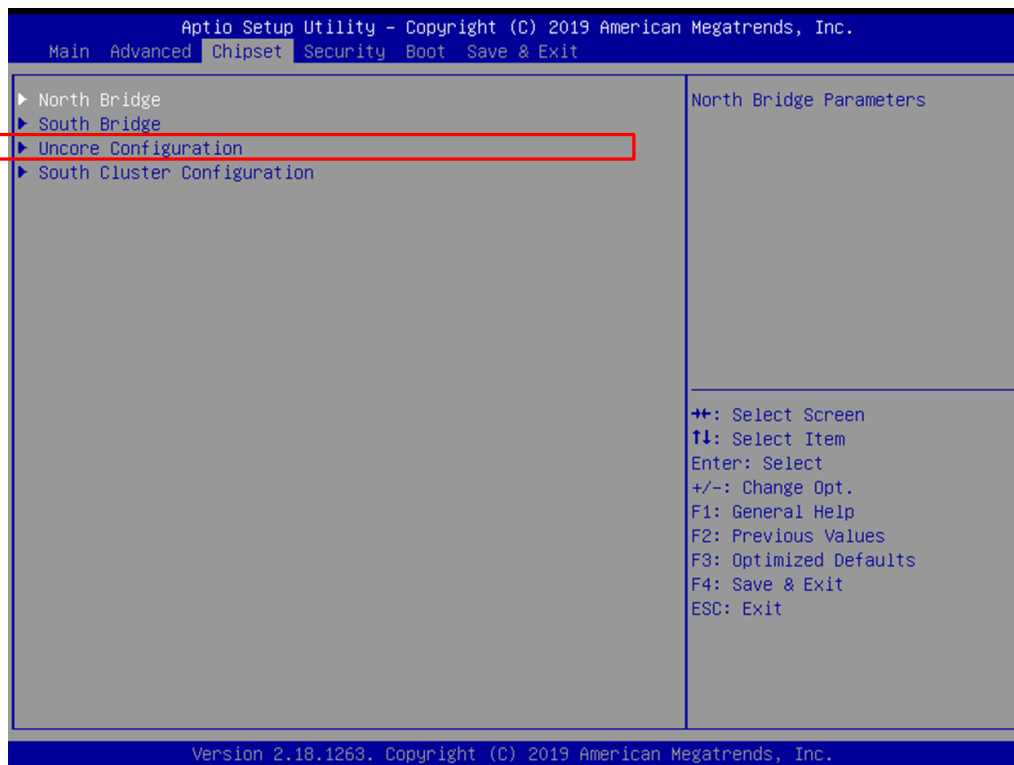

- **Integrated Graphics Device**

Enable: Enable Integrated Graphics Device (IGD) when selected as the primary video adaptor

Disable: Always disable IGD

■ **Primary Display**

Select which of IGD/PCI Graphics device should be Primary Display

■ **RC6 (Render Standby)**

Check to enable render standby support, RC6 should be enabled if S0ix is enabled. This item will be read only if S0ix is enabled

■ **GTT Size**

Select the GTT Size

■ **Aperture Size**

Select the Aperture Size

■ **DVMT Pre-Allocated**

Select DVMT 5.0 Pre-Allocated (Fixed) Graphics Memory size used by the Internal Graphics Device

■ **DVMT Total Gfx Mem**

Select DVMT 5.0 Total Graphic Memory size used by the Internal Graphics Device

■ **Cd Clock Frequency**

Select the highest Cd Clock frequency supported by the platform

■ **GT PM Support**

Enable/Disable GT PM Support

■ **PAVP Enable**

Enable/Disable PAVP

■ **Memory Configuration (Title)**

Enable/Disable Memory Scrambler

3.2.2.4 South Cluster Configuration

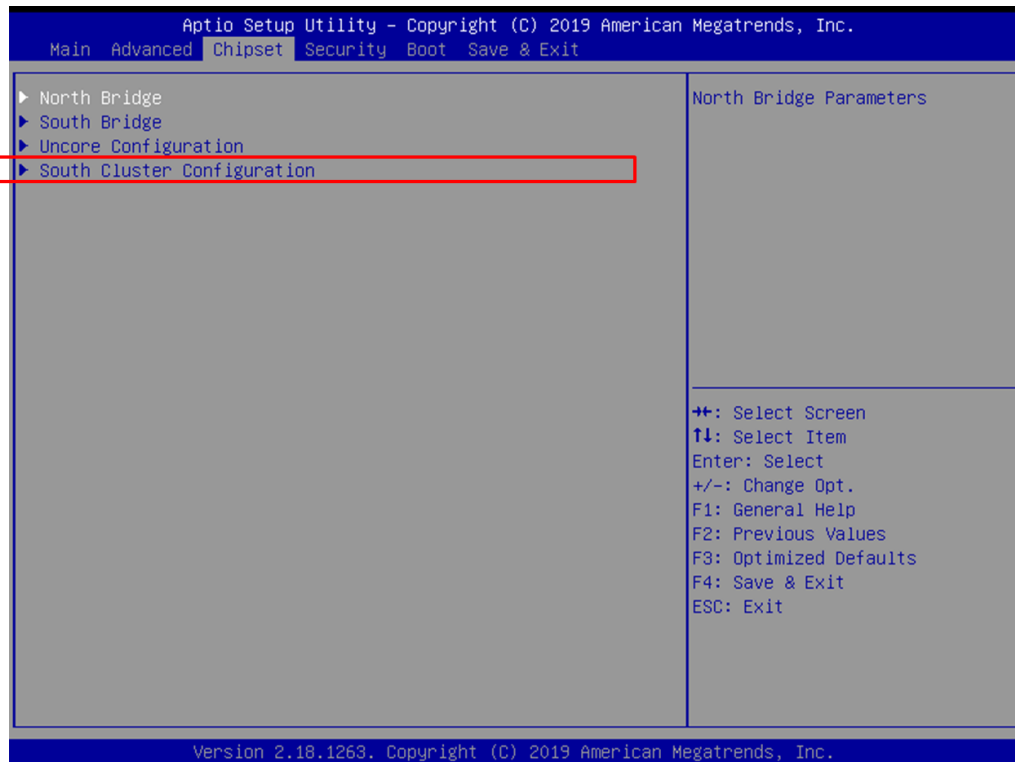

- **PCI Express Configuration**
- **SATA Drives**
- **LAN1 Control**
Enable or disable the LAN 1/2/3 control

- **HD-Audio Support**
Enable or disable HD-Audio Support
- **Restore AC Power Loss**
This item allows users to select "off", "on" and "last state"
- **BIOS Lock**
Enable/Disable the BIOS Lock Enable feature
- **RTC Lock**
Enable or disable bytes 38h-3Fh in the upper and lower 128-byte bank of RTC RAM lockdown
- **Flash Protection Range Registers**
Enable or disable Flash Protection Range Registers
- **PCIE Wake**
Enable or disable PCIE to wake the system from S5



- **PCI Express Clock Gating**
Enable/Disable PCI Express Clock Gating
- **Compliance Mode**
Enable/Disable Compliance Mode
- **Mini PCIE**
On/Off/Auto control of PCI Express port
Enable/Disable ASPM
L1 Substates settings
PCIe Speed settings

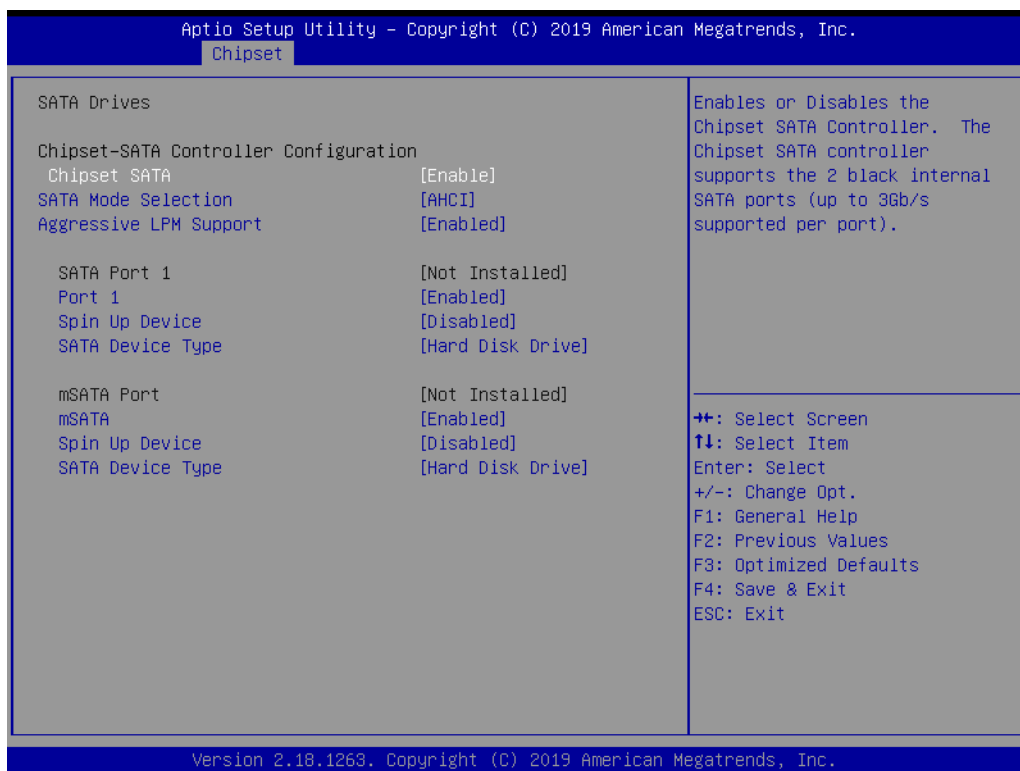

- **Chipset SATA**
Enables or disables the chipset SATA controller. The chipset SATA controller supports the 1 blank internal SATA ports (up to 3Gb/s supported)
- **SATA Mode Selection**
This item allows users to select mode of SATA controller(s)
- **Aggressive LPM Support**
This item allows users to enable or disable Aggressive LPM Support
- **Port 1**
This item allows users to enable or disable the Serial-ATA Port 1 device
- **Spin Up Device**
This item allows users to enable or disable the Spin Up Device
- **SATA Device Type**
Identify the SATA port is connected to Solid State Drive or Hard Disk Drive
- **mSATA**
This item allows users to enable or disable the Serial-ATA Port 1 device
- **Spin Up Device**
This item allows users to enable or disable the Spin Up Device
- **SATA Device Type**
Identify the SATA port is connected to Solid State Drive or Hard Disk Drive

3.2.3 Security

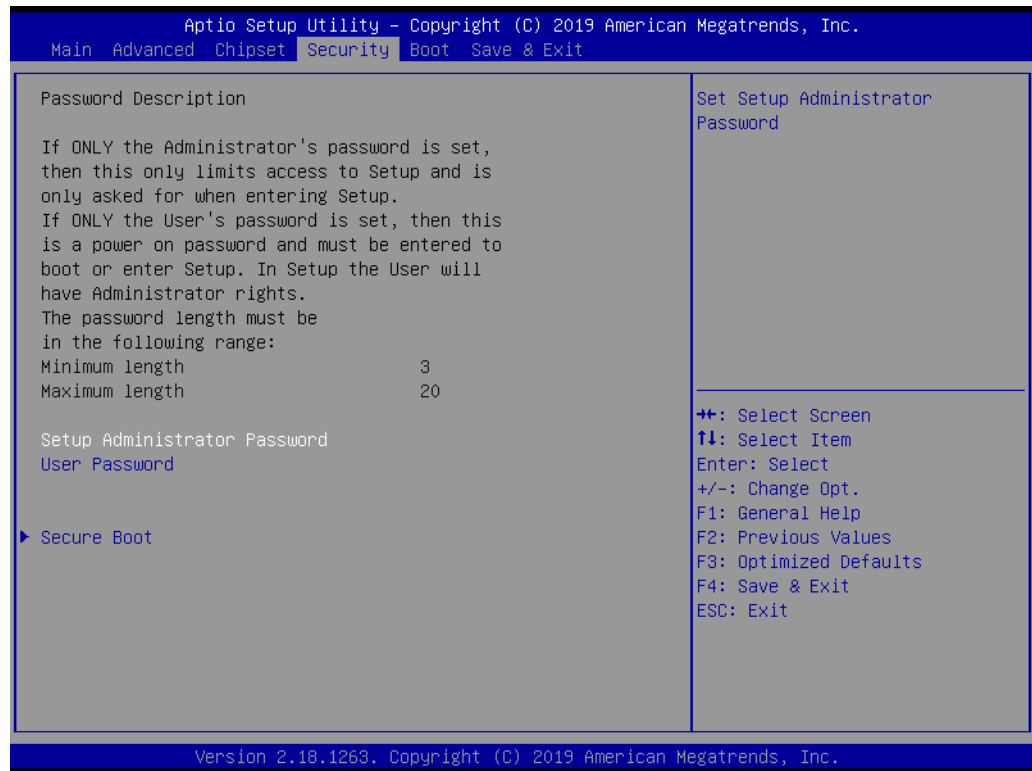

Select Security Setup from the AIMB-U217 Setup main BIOS setup menu. All Security Setup options, such as password protection and virus protection are described in this section. To access the sub menu for the following items, select the item and press <Enter>: Change Administrator / User Password.

3.2.3.1 Secure Boot



- **Secure Boot**
Secure Boot activated when platform key (PK) is enrolled, system mode is user/deployed, and CSM function is disabled.
- **Secure Boot Customization**
Secure Boot mode - Custom & Standard, Set UEFI Secure Boot Mode to STANDARD mode or CUSTOM mode, this change is effect after save. And after reset, the mode will return to STANDARD mode.

3.2.4 Boot

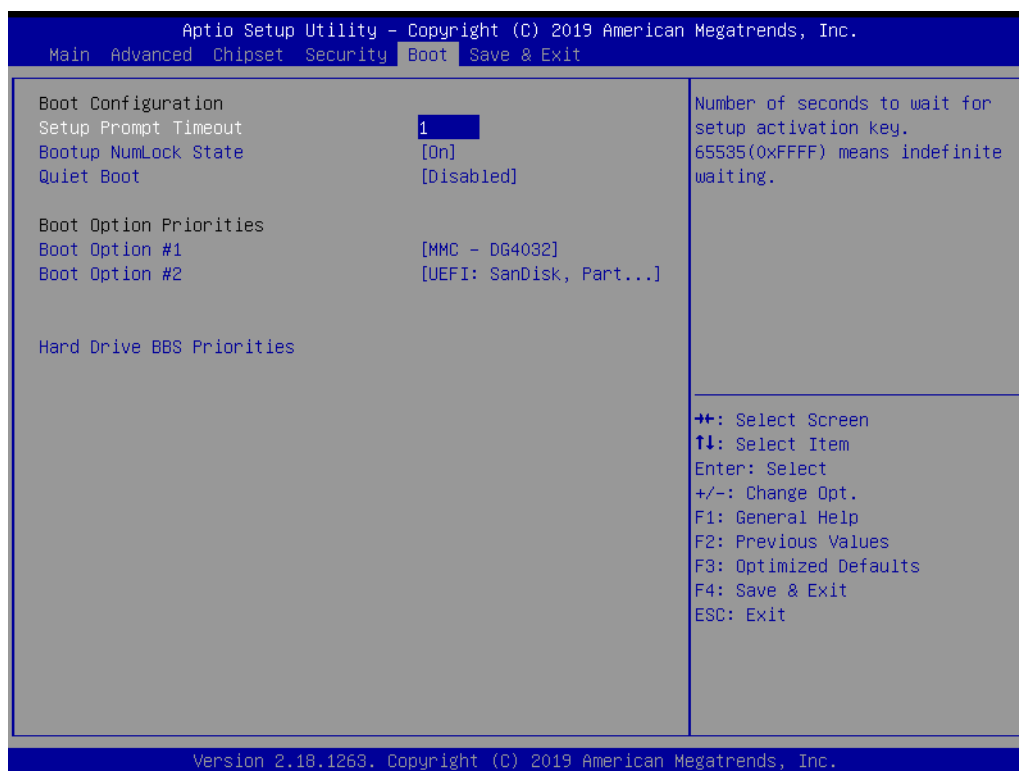

- **Bootup NumLock State**
Select the keyboard Numlock state
- **Quiet Boot**
Enables or disableds Quiet Boot option

3.2.5 Save and Exit

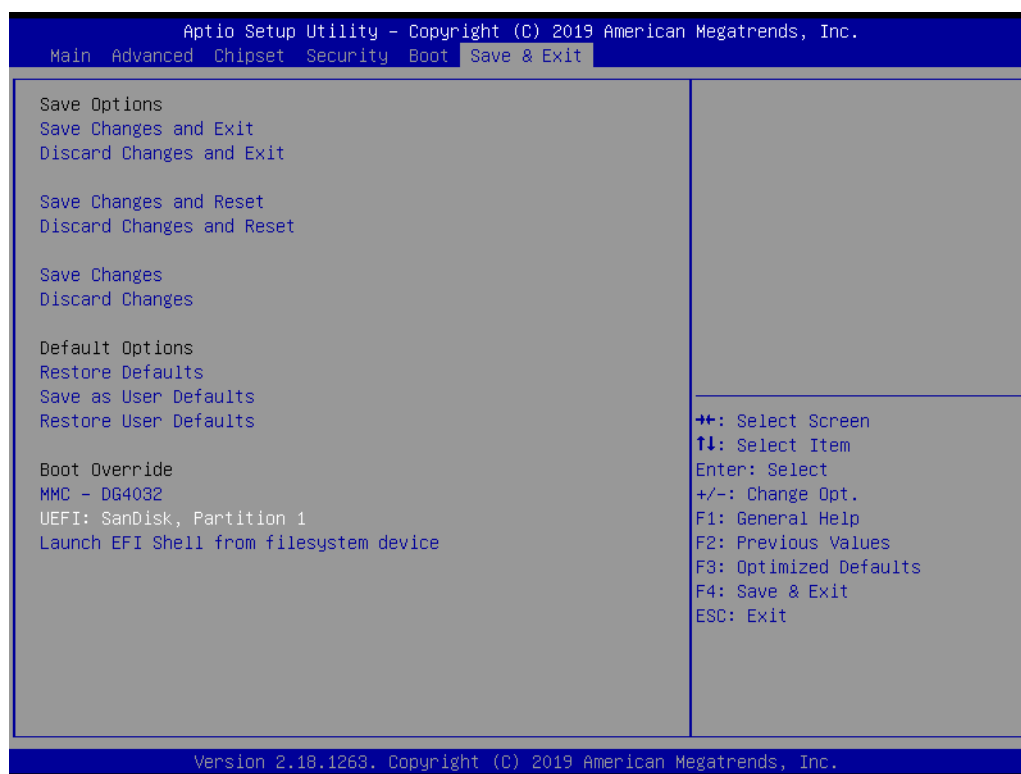

- **Save Changes and Exit**
This item allows users to exit system setup after saving changes
- **Discard Changes and Exit**
This item allows users to exit the system setup without saving changes
- **Save Changes and Reset**
This item allows users to reset the system setup after saving changes
- **Discard Changes and Reset**
This item allows users to reset the system setup without saving changes
- **Save Changes**
This item allows users to save changes done so far to any of the setup options
- **Discard Changes**
This item allows users to discard changes done so far to any of the setup options
- **Restore Defaults**
This item allows users to restore/load the default values for all options
- **Save as User Defaults**
This item allows users to save changes done so far as user defaults
- **Restore User Defaults**
This item allows users to restore the user defaults for all options
- **Launch EFI Shell From a File system Device**
Attempts to Launch EFI Shell application (Shell.efi) from one of the available filesystem devices

Chapter 4

Software and Service
Introduction

4.1 Introduction

The mission of Advantech Embedded Software Services is to “enhance user quality of life with Advantech platforms and Microsoft® Windows® embedded technology.” We equip Advantech platforms with Windows® embedded software products to more effectively support the embedded computing community. This eliminates the hassle of dealing with multiple vendors (hardware suppliers, system integrators, and embedded OS distributors) for specific projects. Our aim is to make Windows® embedded software solutions widely available to the embedded computing community.

4.2 Value-Added Software Services

Software API: An interface that defines the ways in which an application program may request services from libraries and/or operating systems. This software provides not only the underlying drivers required, but also a rich set of user-friendly, intelligent, and integrated interfaces that speed development, enhance security, and offer add-on value for Advantech platforms. Furthermore, this software serves as a catalyst between developers and solutions, making Advantech embedded platforms easier and simpler to adopt and operate with customer applications.

4.2.1 Software API

4.2.1.1 Control

GPIO



General purpose input/output is a flexible parallel interface that allows various custom connections. This interface also enables users to monitor the level of signal input or set the output status to switch the device on or off. Our API also provides programmable GPIO, enabling developers to dynamically set the GPIO input or output status.

SMBus



SMBus is a system management bus defined by Intel Corporation in 1995. This interface is used in personal computers and servers for low-speed system management communications. The SMBus API allows developers to interface with an embedded system environment and transfer serial messages using SMBus protocols, facilitating multiple simultaneous device control.

4.2.1.2 Display

Brightness Control



The Brightness Control API allows developers to access embedded devices and easily control brightness.

Backlight



The Backlight API allows developers to control the backlight (screen) in embedded devices.

4.2.1.3 Monitor

Watchdog



A watchdog timer is a device that performs a specific operation after a specified period of time when a malfunction occurs and the system cannot recover on its own. A watchdog timer can be programmed to perform a warm booting (system restart) after a certain number of seconds.

Hardware Monitor



The Hardware Monitor API is a system health supervision API that inspects certain condition indices, such as fan speed, temperature, and voltage.

4.2.1.4 Power Saving

CPU Speed



This feature uses Intel SpeedStep® Technology to reduce the system power consumption. The system automatically adjusts the CPU speed according to the system load.

System Throttling

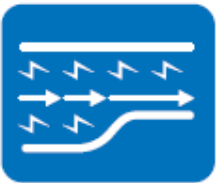

This refers to a series of methods for reducing system power consumption by lowering the clock frequency. This API allows users to adjust the clock frequency from 87.5% to 12.5%.

4.2.2 Software Utility

BIOS Flash

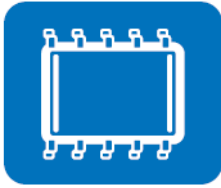

The BIOS Flash utility allows customers to update the flash ROM BIOS version, or backup the current BIOS by copying the configuration from the flash chip to a file on the users' disk. The BIOS Flash utility also features a command line version and API for rapid implementation in customized applications.

Embedded Security ID



Embedded applications are the most important responsibilities for system integrators because they contain valuable intellectual property, design knowledge, and innovations, and are easily copied. This Embedded Security ID utility offers reliable security functions that allow users to secure application data within embedded BIOS.

Monitoring



The Monitoring API is a utility that allows users to monitor the system health indicators, such as voltage, CPU and system temperature, and fan speed. These system values are crucial. If critical errors occur and are not solved immediately, permanent damage to the device may result.

Chapter 5

Chipset Software
Installation Utility

5.1 Before Installation

Before installing the enhanced display drivers and utility software, please read the instructions provided in this chapter carefully. The drivers for AIMB-U217 are provided on the Advantech support website: <http://support.advantech.com/Support/>. This driver will guide and link users to the utilities and drivers required for Microsoft Windows-based systems. Software updates can be accessed from Microsoft* software service packs.

Note! *The files on the website are compressed. Do not attempt to install the drivers by copying the files manually. The Setup program provided must be used to install the drivers.*



Please note, for most display drivers the relevant software application must be installed on the system before enhanced display drivers can be installed. In addition, for many of the installation procedures, user familiarity with both the relevant software applications and operating system commands is assumed. Thus, users are advised to review relevant operating system commands and pertinent sections of the application software user manual before attempting installation.

5.2 Introduction

The Intel® Chipset Software Installation (CSI) utility installs the Microsoft Windows INF files that specify the chipset component configuration on the OS. This is essential to enable the following features and functionality:

- Core PCI PnP services
- Serial ATA interface support
- USB support
- Identification of Intel® chipset components in the device manager

Note! *This utility is used for the following versions of Windows, and it has to be installed before installing all the other drivers:*



- Windows 10 (64 bit)

Chapter 6

Graphics Setup

6.1 Introduction

To benefit from the Intel® Atom x7-E3950/ x5-E3940 integrated graphics controller, users must install the graphics driver.

6.2 Windows 10

Note! Before installing this driver, ensure the CSI utility is installed on the system. See Chapter 5 for information regarding installing the CSI utility.



Download the driver from website on your computer. Navigate to the "Graphics" folder and click "setup.exe" to complete the installation of the drivers for Windows 10.

Win 10(64bit) Driver for AIMB-U217

Solution : Win 10(64bit) Driver for AIMB-U217

Download File	Released Date	Download Site	
AIMB-U217_Audio_Win10(64bit).zip	2019-10-02	Primary	Secondary
AIMB-U217_Chipset_Win10(64bit).zip	2019-10-02	Primary	Secondary
AIMB-U217_Graphic_Win10(64bit).zip	2019-10-02	Primary	Secondary
AIMB-U217_Intel LAN_Win10(64bit).zip	2019-10-02	Primary	Secondary
AIMB-U217_Intel TXE_Win10(64bit).zip	2019-10-02	Primary	Secondary
AIMB-U217_Others_Win10(64bit).zip	2019-10-02	Primary	Secondary
AIMB-U217_Realtek LAN_Win10(64bit).zip	2019-10-02	Primary	Secondary

Chapter 7

LAN Configuration

7.1 Introduction

The AIMB-U217 system features triple Gigabit Ethernet LANs via dedicated PCI Express x1 lanes (Intel i211AT (LAN1/2) and Realtek RTL8111G (LAN3)).

7.2 Features

- Integrated 10/100/1000 Mbps transceiver
- 10/100/1000 Mbps triple-speed MAC
- Wake-on-LAN (WOL) support
- PCI Express X1 host interface

7.3 Installation

Note! Before installing LAN drivers, ensure the CSI utility is installed on the system. See Chapter 5 for information regarding installing the CSI utility.



The Intel i211AT (LAN1/2) and Realtek 8111G (LAN3) Gigabit integrated controllers support all major network operating systems. However, the installation procedure varies between systems. Please follow the driver setup procedure instructions specific to the operating system installed.

7.4 Windows 10 Driver Setup

Download the driver from website on your computer. Navigate to the LAN drivers folder and click "setup.exe" to complete the installation of the drivers.

Win 10(64bit) Driver for AIMB-U217		
Solution : Win 10(64bit) Driver for AIMB-U217		
Download File	Released Date	Download Site
AIMB-U217_Audio_Win10(64bit).zip	2019-10-02	Primary Secondary
AIMB-U217_Chipset_Win10(64bit).zip	2019-10-02	Primary Secondary
AIMB-U217_Graphic_Win10(64bit).zip	2019-10-02	Primary Secondary
AIMB-U217_Intel LAN_Win10(64bit).zip	2019-10-02	Primary Secondary
AIMB-U217_Intel TXE_Win10(64bit).zip	2019-10-02	Primary Secondary
AIMB-U217_Others_Win10(64bit).zip	2019-10-02	Primary Secondary
AIMB-U217_Realtek LAN_Win10(64bit).zip	2019-10-02	Primary Secondary

Appendix **A**

Pin Assignments

A.1 Pin Assignments

Connector and Header List:

A.1.1 Line-Out Connector (Audio1)

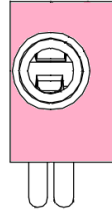

Pin	Signal
1	Line-out

A.1.2 MIC-in Pin Header (Audio2)



USB			
Pin	Signal	Pin	Signal
1	MIC-L	3	Analog GND
2	MIC-R	4	Jack detect

A.1.3 CMOS Battery Connector (BAT1)

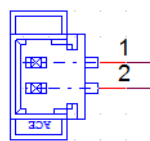

Pin	Signal
1	+VBAT
2	GND

A.1.4 CAN Bus Connector (CAN1)

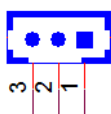

Pin	Signal
1	CAN_H
2	CAN_L
3	CAN_GND

A.1.5 COM1 Pin Header (COM1)

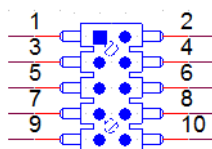

Pin	Signal	Pin	Signal
1	DCD#	2	DSR#
3	RXD	4	RTS#
5	TXD	6	CTS#
7	DTR	8	RI#
9	GND	10	N.C.

A.1.6 COM2 Pin Header (COM2)

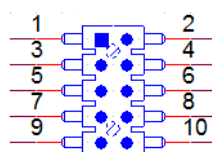

Pin	Signal	Pin	Signal
1	DCD#	2	DSR#
3	RXD	4	RTS#
5	TXD	6	CTS#
7	DTR	8	RI#
9	GND	10	N.C.

A.1.7 COM3 Pin Header (COM3)

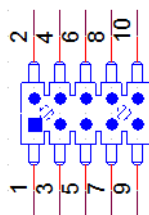

Pin	Signal	Pin	Signal
1	DCD#	2	DSR#
3	RXD	4	RTS#
5	TXD	6	CTS#
7	DTR	8	RI#
9	GND	10	N.C.

A.1.8 COM4 Pin Header (COM4)

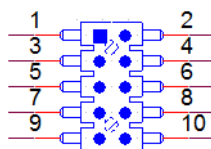

Pin	Signal	Pin	Signal
1	DCD#	2	DSR#
3	RXD	4	RTS#
5	TXD	6	CTS#
7	DTR	8	RI#
9	GND	10	N.C.

A.1.9 CPU FAN Connector (CPUFAN1)

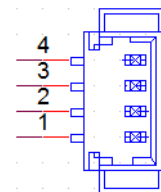

Pin	Signal
1	GND
2	+12V
3	DETECT
4	PWM IN

A.1.10 Direct Current Input Connector (DCIN1)

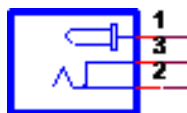

Pin	Signal
1	12V~24V
2	GND
3	GND

A.1.11 Direct Current Input Connector (DCIN2)

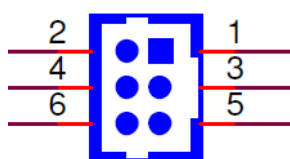

Pin	Signal	Pin	Signal
1	12V~24V	2	GND
3	12V~24V	4	GND
5	12V~24V	6	GND

A.1.12 DDR3L SO-DIMM Socket (DIMMA1)

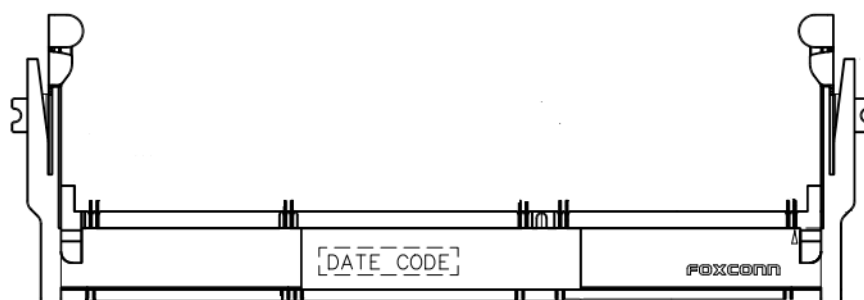

Please see JEDEC STANDARD

A.1.13 DisplayPort + High-Definition Multimedia Interface Connector (DP1+HDMI1)

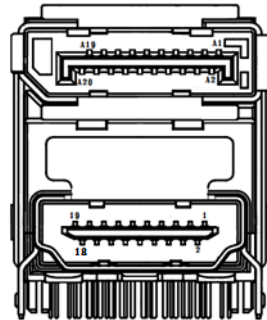

Pin	Signal	Pin	Signal
A1	DP_0+	A2	GND
A3	DP_0-	A4	DP_1+
A5	GND	A6	DP_1-
A7	DP_2+	A8	GND
A9	DP_2-	A10	DP_3+
A11	GND	A12	DP_3-
A13	DP_AUX_EN#	A14	GND
A15	DP_AUX+	A16	GND
A17	DP_AUX-	A18	DP_HPD
A19	GND	A20	+V3.3

Pin	Signal	Pin	Signal
1	HDMI_D2+	2	GND
3	HDMI_D2-	4	HDMI_D1+
5	GND	6	HDMI_D1-
7	HDMI_D0+	8	GND
9	HDMI_D0-	10	HDMI_CLK+
11	GND	12	HDMI_CLK-
13	N.C.	14	N.C.
15	HDMI_SCL	16	HDMI_SDA
17	GND	18	+V5
19	HDMI_HPD		

A.1.14 16-Bit General Purpose I/O Pin Header (GPIO1)

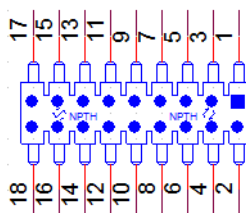

Pin	Signal	Pin	Signal
1	GPIO0	2	GPIO8
3	GPIO1	4	GPIO9
5	GPIO2	6	GPIO10
7	GPIO3	8	GPIO11
9	GPIO4	10	GPIO12
11	GPIO5	12	GPIO13
13	GPIO6	14	GPIO14
15	GPIO7	16	GPIO15
17	+V5 stand by	18	GND

A.1.15 EDP/LVDS Backlight Inverter Power Connector (INV1)



Pin	Signal
1	+V12
2	GND
3	Backlight enable
4	Brightness
5	+V5

A.1.16 CMOS Clear Pin Header (JCMOS1)

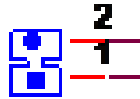

Pin	Signal
1	RTC RESET#
2	GND

A.1.17 PWRBTN#/RESET#/HDD LED/PWR LED Pin Header (JFP1)

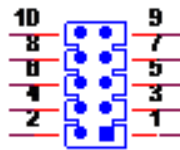

Pin	Signal	Pin	Signal
1	GND	2	PWRBTN#
3	+V3.3	4	PWRBTN#
5	HDD_LED#	6	GND
7	+V3.3 stand by	8	RESET#
9	PWR LED#	10	GND

A.1.18 Voltage Selection for LVDS_EDP1 Connector (JLVDS1)

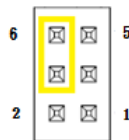

Pin	Signal	Pin	Signal
1	N.C	2	+V5
3	+V12	4	VDD_LVDS
5	N.C	6	+V3.3

A.1.19 CMOS1 RI# Selection Pin Header (JSETCOM1_V1)

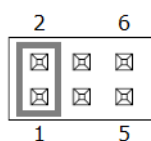

Pin	Signal	Pin	Signal
1	RI#	2	Advantech define
3	Advantech define	4	+V5
5	+V12	6	Advantech define

A.1.20 RJ45 #1/2 (LAN12)

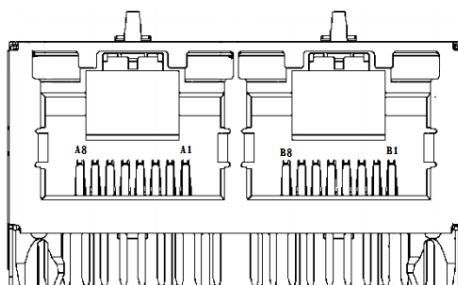

Pin	Signal	Pin	Signal
A1	LAN1_MDI0+	B1	LAN2_MDI0+
A2	LAN1_MDI0-	B2	LAN2_MDI0-
A3	LAN1_MDI1+	B3	LAN2_MDI1+
A4	LAN1_MDI1-	B4	LAN2_MDI1-
A5	LAN1_MDI2+	B5	LAN2_MDI2+
A6	LAN1_MDI2-	B6	LAN2_MDI2-
A7	LAN1_MDI3+	B7	LAN2_MDI3+
A8	LAN1_MDI3-	B8	LAN2_MDI3-

A.1.21 RJ45 #3 (LAN3)

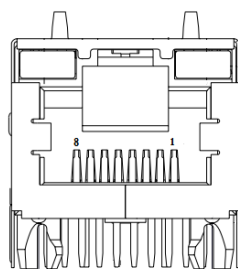

Pin	Signal
1	LAN3_MDI0+
2	LAN3_MDI0-
3	LAN3_MDI1+
4	LAN3_MDI1-
5	LAN3_MDI2+
6	LAN3_MDI2-
7	LAN2_MDI3+
8	LAN2_MDI3-

A.1.22 Low Pin Count Interface Connector (LPC1)

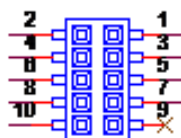

Pin	Signal	Pin	Signal
1	LPC_AD1	2	CLK_25M
3	LPC_AD0	4	PLTRST#
5	+V3.3	6	LPC_FRAME#
7	GND	8	LPC_AD3
9	N.C	10	LPC_AD2

A.1.23 Low-Voltage Differential Signaling Interface/Embedded Display Port (LVDS_EDP1)

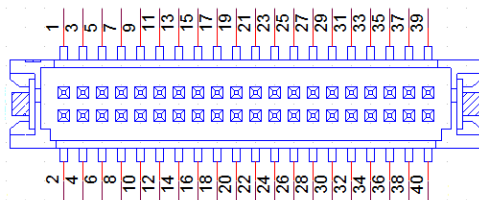

Pin	Signal	Pin	Signal
1	VDD	2	VDD
3	DETECT#	4	GND
5	VDD	6	VDD
7	A0N(EDP_CPU_TXN2)	8	A4N
9	A0P(EDP_CPU_TXP2)	10	A4P
11	GND	12	GND
13	A1N(EDP_CPU_TXN1)	14	A5N
15	A1P(EDP_CPU_TXP1)	16	A5P
17	GND	18	GND
19	A2N(EDP_CPU_TXN0)	20	A6N
21	A2P(EDP_CPU_TXP0)	22	A6P
23	GND	24	GND
25	CLK1N(EDP_CPU_TXN3)	26	CLK2N
27	CLK1P(EDP_CPU_TXP3)	28	CLK2P
29	GND	30	GND
31	(EDP_CPU_AUXP)	32	(EDP_CPU_AUXN)
33	GND	34	GND (EDP_HPD)
35	A3N	36	A7N
37	A3P	38	A7P
39	ENBKL	40	VCON

A.1.24 NGFF M.2 E-Key Connector for 2230 Module (M.2_1)

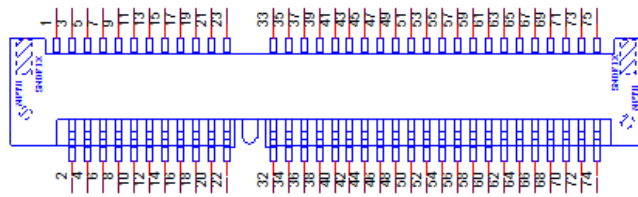

Pin	Signal	Pin	Signal
1	GND	2	+V3.3SB_M.2
3	USB+	4	+V3.3SB_M.2
5	USB-	6	N.C.
7	GND	8	I2S3_BCLK
9	SDIO_CLK	10	I2S3_SYNC
11	SDIO_CMD	12	I2S3_SDI
13	SDIO_DAT0	14	I2S3_SDO
15	SDIO_DAT1	16	N.C.
17	SDIO_DAT2	18	GND
19	SDIO_DAT3	20	UART_WAKE#
21	SDIO_WAKE#	22	UART_RXD
23	SDIO_RST#		
		32	UART_TXD
33	GND	34	UART_CTS#
35	PCIE_TX+	36	UART_RTS#
37	PCIE_TX-	38	N.C.
39	GND	40	N.C.
41	PCIE_RX+	42	N.C.
43	PCIE_RX-	44	N.C.
45	GND	46	N.C.
47	PCIE_CLK100M+	48	N.C.
49	PCIE_CLK100M-	50	SUSCLK
51	GND	52	PLTRST#
53	CLKREQ#	54	BT_DISABLE#
55	PCIE_WAKE#	56	WIFI_DISABLE#
57	GND	58	N.C.
59	N.C.	60	N.C.
61	N.C.	62	N.C.
63	GND	64	N.C.
65	N.C.	66	N.C.
67	N.C.	68	N.C.
69	GND	70	N.C.
71	N.C.	72	+V3.3SB_M.2
73	N.C.	74	+V3.3SB_M.2
75	GND		

A.1.25 Mini PCIE Connector (MINI-PCIE1)

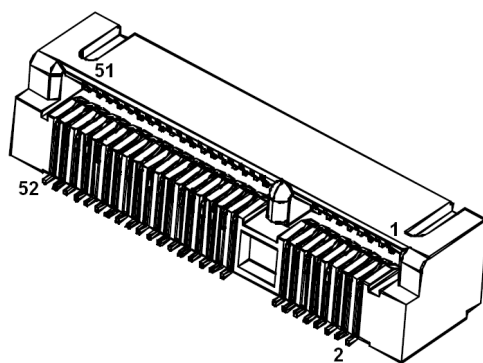

Pin	Signal	Pin	Signal
1	WAKE#	2	+3.3Vaux
3	Reserved	4	GND
5	Reserved	6	+1.5V
7	CLKREQ#	8	Reserved
9	GND	10	Reserved
11	REFCLK-	12	Reserved
13	REFCLK+	14	Reserved
15	GND	16	Reserved
17	Reserved	18	GND
19	Reserved	20	DISABLE#
21	DETECT#	22	RESET#
23	PCIE_RX+	24	+3.3Vaux
25	PCIE_RX-	26	GND
27	GND	28	+1.5V
29	GND	30	SMB_CLK
31	PCIE_TX-	32	SMB_DATA
33	PCIE_TX+	34	GND
35	GND	36	USB_D-
37	GND	38	USB_D+
39	+3.3Vaux	40	GND
41	+3.3Vaux	42	Reserved
43	V1.2_DETECT#	44	LED_WLAN#
45	Reserved	46	Reserved
47	Reserved	48	+1.5V
49	Reserved	50	GND
51	MSATA_DETECT#	52	+3.3Vaux

A.1.26 AT/ATX Mode Selection (PSON1)

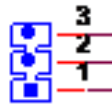

Pin	Signal
1	VCCAT
2	+V3.3 stand by
3	VCCATX

A.1.27 Serial ATA Interface Connector (SATA1)

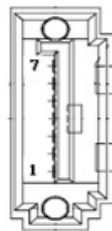

Pin	Signal
1	GND
2	TX+
3	TX-
4	GND
5	RX-
6	RX+
7	GND

A.1.28 Serial ATA Interface Power Connector (SATAPWR1)



Pin	Signal
1	+V5
2	GND
3	GND
4	+V12

A.1.29 I2C Header (SIOI2C)

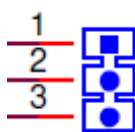

Pin	Signal
1	CLK
2	DATA
3	GND

A.1.30 SPI Pin Header (SPI_CN1)

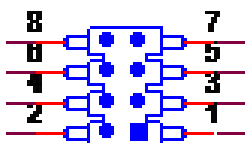

Pin	Signal	Pin	Signal
1	SPI_CS	2	+V1.8SB_SPI
3	SPI_MISO	4	N.C.
5	N.C.	6	SPI_CLK
7	GND	8	SPI_MOSI

A.1.31 System FAN Connector (SYSFAN1)

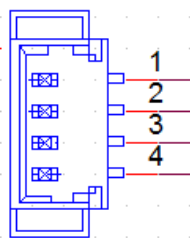

Pin	Signal
1	GND
2	+12V
3	DETECT
4	PWM IN

A.1.32 Universal Serial Bus 3.0 Connector #1/2 (USB12)

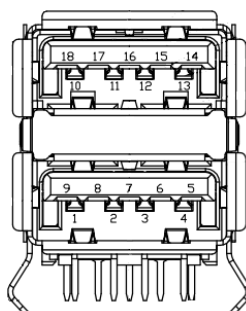

Pin	Signal	Pin	Signal
1	+VCC_USB	5	USB3.0_RX0-
2	USB2.0_D0-	6	USB3.0_RX0+
3	USB2.0_D0+	7	GND.
4	GND	8	USB3.0_TX0-
		9	USB3.0_TX0+
Pin	Signal	Pin	Signal
10	+VCC_USB	14	USB3.0_RX1-
11	USB2.0_D1-	15	USB3.0_RX1+
12	USB2.0_D1+	16	GND.
13	GND	17	USB3.0_TX1-
		18	USB3.0_TX1+

A.1.33 Universal Serial Bus 3.0 Connector #3/4 (USB34)

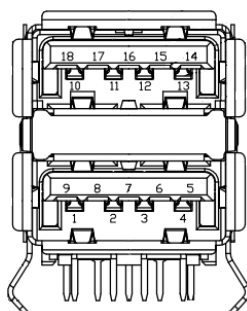

Pin	Signal	Pin	Signal
1	+VCC_USB	5	USB3.0_RX2-
2	USB2.0_D2-	6	USB3.0_RX2+
3	USB2.0_D2+	7	GND.
4	GND	8	USB3.0_TX2-
		9	USB3.0_TX2+
Pin	Signal	Pin	Signal
10	+VCC_USB	14	USB3.0_RX3-
11	USB2.0_D3-	15	USB3.0_RX3+
12	USB2.0_D3+	16	GND.
13	GND	17	USB3.0_TX3-
		18	USB3.0_TX3+

A.1.34 Universal Serial Bus 2.0 Connector #5/6 (USB0506)

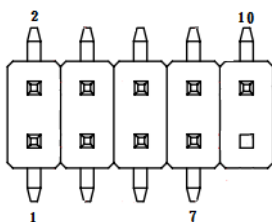

Pin	Signal	Pin	Signal
1	+VCC_USB	2	+VCC_USB
3	USB2.0_D4-	4	USB2.0_D5-
5	USB2.0_D4+	6	USB2.0_D5+
7	GND	8	GND
		10	N.C

ADVANTECH

Enabling an Intelligent Planet

www.advantech.com

Please verify all specifications before quoting. This guide is intended for reference purposes only.

All product specifications are subject to change without notice.

No part of this publication may be reproduced in any form or by any means, electronic, photocopying, recording or otherwise, without prior written permission from the publisher.

All brand and product names are trademarks or registered trademarks of their respective companies.

© Advantech Co., Ltd. 2019

Our company network supports you worldwide with offices in Germany, Austria, Switzerland, the UK and the USA. For more information please contact:

Headquarters

Germany



FORTEC Elektronik AG

Augsburger Str. 2b
82110 Germering

Phone: +49 89 894450-0
E-Mail: info@forteca.de
Internet: www.forteca.de

Fortec Group Members

Austria



Distec GmbH Office Vienna

Nuschinggasse 12
1230 Wien

Phone: +43 1 8673492-0
E-Mail: info@distec.de
Internet: www.distec.de

Germany



Distec GmbH

Augsburger Str. 2b
82110 Germering

Phone: +49 89 894363-0
E-Mail: info@distec.de
Internet: www.distec.de

Switzerland



ALTRAC AG

Bahnhofstraße 3
5436 Würenlos

Phone: +41 44 7446111
E-Mail: info@altrac.ch
Internet: www.altrac.ch

United Kingdom



Display Technology Ltd.

Osprey House, 1 Osprey Court
Hichingbrooke Business Park
Huntingdon, Cambridgeshire, PE29 6FN

Phone: +44 1480 411600
E-Mail: info@displaytechnology.co.uk
Internet: www.displaytechnology.co.uk

USA



Apollo Display Technologies, Corp.

87 Raynor Avenue,
Unit 1 Ronkonkoma,
NY 11779

Phone: +1 631 5804360
E-Mail: info@apolloDisplays.com
Internet: www.apolloDisplays.com