

OUR GLOBAL  
COMPETENCE  
CENTRES

 APOLLO DISPLAY  
TECHNOLOGIES



 DISTEC



 DISPLAY  
TECHNOLOGY

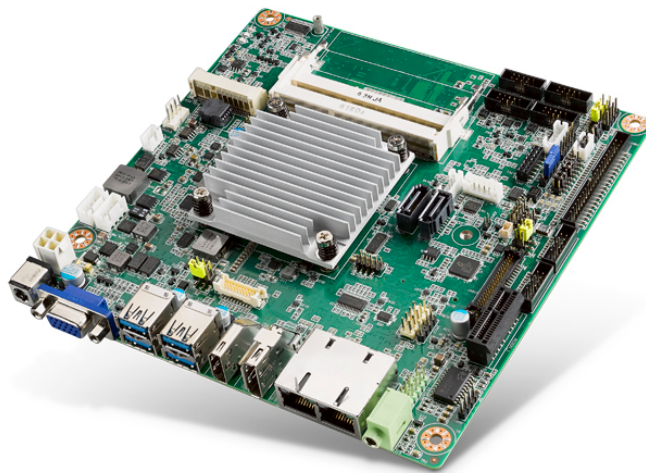


# Manual

## Advantech

### AIMB-217

Mini-ITX Motherboard with Apollo Lake  
Intel® Atom, Pentium or Celeron SoC



---

The information contained in this document has been carefully researched and is, to the best of our knowledge, accurate. However, we assume no liability for any product failures or damages, immediate or consequential, resulting from the use of the information provided herein. Our products are not intended for use in systems in which failures of product could result in personal injury. All trademarks mentioned herein are property of their respective owners. All specifications are subject to change without notice.

---

## AIMB-217

**AIMB-217 Intel® Pentium N4200 & Celeron N3350 & Atom x7-E3950 Mini-ITX HDMI/DP (or LVDS)/VGA (or eDP), 6 COM, and Dual LAN, 8 USB, 1 MiniPCle and 1 M.2 E key, PCIe x1**

---

## Copyright

The documentation and the software included with this product are copyrighted 2017 by Advantech Co., Ltd. All rights are reserved. Advantech Co., Ltd. reserves the right to improve the products described in this manual at any time without notice. No part of this manual may be reproduced, copied, translated or transmitted in any form or by any means without prior written permission from Advantech Co., Ltd. The information provided in this manual is intended to be accurate and reliable. However, Advantech Co., Ltd. assumes no responsibility for its use, nor for any infringements of the rights of third parties, which may result from its use.

## Acknowledgements

IBM and PC are trademarks of International Business Machines Corporation.

Intel® Pentium/Celeron/Atom N4200/N3350/x7-E3950 is trademark of Intel Corporation

Nuvoton is a trademark of Nuvoton Corporation.

All other product names or trademarks are the property of their respective owners.

# Message to the Customer

## Advantech Customer Services

Every Advantech product is built with the most exact specifications to ensure reliable performance in the harsh and demanding conditions typical of industrial environments. Whether your new Advantech equipment is destined for a laboratory or factory floor, be assured that your product can provide the reliability and ease of operation for which the name Advantech is renowned.

Your satisfaction is our primary concern. A guide to Advantech's customer services is provided below. To ensure that you receive the full benefit of our services, please follow the instructions below.

## Technical Support

We want you to get the maximum performance from your products. Should you encounter any technical difficulties, we are available to provide assistance. Answers to the most frequently asked questions are provided in the product documentation. These answers are typically a lot more detailed than the ones provided over the phone.

So please consult this manual first. If you still cannot find the answer, gather all relevant information or questions that apply to your problem, and with the product close to hand, call your dealer. Our dealers are well trained and ready to provide the support required for you to experience the most from your Advantech products. Most of the problems reported are minor and can be easily solved over the phone.

In addition, free technical support from Advantech engineers is available every business day. We are always willing to give advice on application requirements or specific information regarding the installation and operation of any of our products.

---

# Declaration of Conformity

## FCC Class B

This device complies with the requirements in Part 15 of the FCC regulations:

Operation is subject to the following two conditions:

- This device may not cause harmful interference.
- This device must accept any interference received, including interference that may cause undesired operation.

This equipment has been tested and found to comply with the limits for a Class B digital device, pursuant to Part 15 of the FCC Regulations. These limits are designed to provide reasonable protection against harmful interference when the equipment is operated in a commercial environment. This equipment generates, uses, and can radiate radio frequency energy and, if not installed and used in accordance with the instruction manual, may cause harmful interference to radio communications. Operation of this device in a residential area is likely to cause harmful interference, in which case users are required to correct the interference at their own expense. The user is advised that any equipment changes or modifications not expressly approved by the party responsible for compliance would void compliance with the FCC regulations and, therefore, the user's authorization to operate the equipment.

**Caution!** *There is a risk of a new battery exploding if incorrectly installed. Do not attempt to recharge, force open, or heat the battery. Replace the battery only with the same or equivalent type recommended by the manufacturer. Discard used batteries according to the manufacturer's instructions.*



## Memory Compatibility

Category	Speed	Capacity	Chip_Vendor	Chip_PN	ADVANTECH P/N	Result
DDR3L	1600	2GB	Advantech	SEC 310 XYK0 K4B2G084GD	AQD-SD3L2GN16-SQ	PASS
DDR3L	1600	4GB	Advantech	SEC 407 XYK0 K4B4G0846B	AQD-SD3L4GN16-SG D DIE NEW	PASS
DDR3L	1600	4GB	ATP	4JE77 D9QBJ	N/A	PASS
DDR3L	1600	4GB	Advantech	SEC 546 BYNA K4B2G0846Q	AQD-SD3L4GN16-SQ	PASS
DDR3L	1333	2GB	Transcend	SEC 234 HYK0 K4B2G0846D	N/A	PASS
DDR3L	1333	4GB	Apacer	4JE77 D9QBJ	96SD3L-4G1333NN-AP	PASS
DDR3L	1600	4GB	Kingston	Kingston	KVR16LS11/4	PASS
DDR3L	1600	1GB	Advantech	SK hynix	AQD-SD3L1GN16-HC	PASS
DDR3L	1333	4GB	Apacer	Micron	78.B2GCY.AT00C	PASS
DDR3L	1600	4GB	Kingston	KVR16LS11/4	D5128EC4BPGGBU	PASS
DDR3L	1600	8GB	Advantech	SQR-SD3L- 8G1600SNL	SEC 422 BYK0 K4B4G0846D	PASS
DDR3L	1600	8GB	ADATA	Micron	ADDS1600W8G11-BMIE	PASS

## Ordering Information

P/N	CPU	Memory	DP or LVDS	HDMI 1.4	VGA/ eDP	GbE LAN	COM	SATA III	USB3.0 /2.0	MiniPCle	M.2 E key	TPM	AMP	PCle x1	Thermal solution	Operating temperature
AIMB-217D-S6A1E	N4200	2	1	1	1 / (1)	2	6	2	4/4	1 x F/S	1	(1)	(2 x 6W)	1	Passive	0~60°C
AIMB-217N-S6A1E	N3350	2	1	1	1 / (1)	2	6	2	4/4	1 x F/S	1	(1)	(2 x 6W)	1	Passive	0~60°C
AIMB-217Z-S6A1E	x7-E3950	2	1	1	1 / (1)	2	6	2	4/4	1 x F/S	1	(1)	(2 x 6W)	1	Passive	-20~70°C

\* ( ) is not populated when MP

---

## Product Warranty (2 years)

Advantech warrants the original purchaser that its products will be free from defects in materials and workmanship for two years from the date of purchase.

This warranty does not apply to any products that have been repaired or altered by persons other than repair personnel authorized by Advantech, or products that have been subject to misuse, abuse, accident, or improper installation. Advantech assumes no liability under the terms of this warranty as a consequence of such events.

Because of Advantech's high quality-control standards and rigorous testing, most customers never need to use our repair service. If an Advantech product is defective, it will be repaired or replaced at no charge during the warranty period. For out-of-warranty repairs, users will be billed according to the cost of replacement materials, service time, and freight. Please consult your dealer for more details.

If you believe your product is defective, please follow the steps listed below.

1. Collect all information about the problem encountered (for example, CPU speed, Advantech products used, other hardware and software used, etc.). Note anything abnormal and list any onscreen messages encountered when the problem occurs.
2. Call your dealer and describe the problem. Please have your manual, product, and any relevant information readily available.
3. If your product is diagnosed as defective, obtain a return merchandise authorization (RMA) number from your dealer. This allows us to process your return more quickly.
4. Carefully pack the defective product, a completed Repair and Replacement Order Card, and proof of the purchase date (such as a photocopy of your sales receipt) in a shippable container. Products returned without a proof of purchase date are not eligible for our warranty service.
5. Write the RMA number clearly on the outside of the package and ship the product prepaid to your dealer.



## Initial Inspection

Before installing the motherboard, please ensure that the following items are included in your shipment:

- 1x AIMB-217 Intel® Pentium N4200 & Celeron N3350 & Atom x7-E3950 Mini-ITX motherboard
- 1 x SATA HDD cable
- 1 x SATA power cable
- 1 x Serial port cable (1 to 4), for AIMB-217D/N/Z SKU
- 2 x Serial port cable (1 to 1)
- 1 x I/O port bracket
- 1 x startup manual
- 1 x warranty card
- 1 x on-board CPU heat sink

If any of these items are missing or damaged, contact your distributor or sales representative immediately. All AIMB-217 devices are mechanically and electrically inspected before shipment. Thus, your product should be free of marks and scratches and in perfect working order upon receipt. While unpacking AIMB-217, check the product for signs of shipping damage (for example, a damaged box, scratches, dents, etc.). If the device is damaged or fails to meet the specifications, notify our service department or your local sales representative immediately. Please also notify the carrier. Retain the shipping carton and packing material for inspection by the carrier. After this inspection, we will make arrangements to repair or replace the unit.



# Contents

## Chapter 1 General Information .....1

1.1	Introduction .....	2
1.2	Features .....	2
1.3	Specifications .....	2
1.3.1	System .....	2
1.3.2	Memory .....	3
1.3.3	Input/Output .....	3
1.3.4	Graphics.....	3
1.3.5	Ethernet LAN .....	3
1.3.6	Industrial Features .....	3
1.3.7	Mechanical and Environmental Specifications.....	3
1.4	Jumpers and Connectors .....	4
	Table 1.1: Connector / Header List.....	4
1.5	Board Layout: Jumper and Connector Locations.....	5
	Figure 1.1 Jumper and Connector Locations.....	5
	Figure 1.2 I/O Connectors .....	6
1.6	AIMB-217 Board Diagram .....	6
	Figure 1.3 AIMB-217 Board Diagram .....	6
1.7	Safety Precautions .....	7
1.8	Jumper Options.....	7
1.8.1	Setting Jumpers .....	7
1.8.2	CMOS Mode Selection (JCMOS1) .....	8
	Table 1.2: CMOS Mode Selection (JCMOS1).....	8
1.8.3	COM3 RS-232/422/485 Mode Selector (JSETCOM3).....	8
	Table 1.3: COM3 RS-232/422/485 Mode Selector (JSETCOM3).....	8
	Table 1.4: COM3 RS-232/422/485 Mode Selector (JSETCOM3).....	9
1.8.4	LVDS/eDP Panel Voltage Selection (JLVDS1/JLVDS2), eDP is BOM optional .....	9
	Table 1.5: LVDS/eDP panel voltage selection (JLVDS1/JLVDS2).....	9
1.8.5	PSON1: ATX and AT Mode Selector .....	9
	Table 1.6: PSON1: ATX and AT Mode Selector.....	9
1.8.6	JWDT1 + JOBS1: Watchdog Timer Output and OBS Beep .....	10
	Table 1.7: JWDT1 + JOBS1: Watchdog Timer Output and OBS Beep .....	10
1.8.7	Case Open Pin Header Selection (JCASEOP_SW1).....	10
	Table 1.8: Case Open Pin Header Selection (JCASEOP_SW1).....	10
1.8.8	Power Switch/HDD LED/SMBus/Speaker Pin Header (JFP1)....	10
	Table 1.9: Power Switch/HDD LED/SMBus/Speaker Pin Header (JFP1).....	10
1.8.9	JEIDA/VESA Selection (JLVDS_VCON1) .....	11
	Table 1.10: JEIDA/VESA Selection (JLVDS_VCON1).....	11
1.8.10	COM6 5V/12V selection (JSETCOM6_V1).....	11
	Table 1.11: COM6 5V/12V selection (JSETCOM6_V1).....	11
1.8.11	Power LED and PS2 keyboard control (JFP2).....	12
	Table 1.12: Power LED and PS2 keyboard control (JFP2) .....	12

## Chapter 2 Connecting Peripherals .....13

2.1	Introduction .....	14
2.2	LAN and USB Ports .....	14
	Table 2.1: LAN LED Indicators .....	14
2.3	VGA Connector (VGA1).....	15

2.4	Serial Ports (COM1 ~ COM6) .....	15
2.5	PS/2 Keyboard and Mouse Connector (KBMS1).....	16
2.6	Display Port Connector (DP1).....	16
2.7	HDMI connector (HDMI1) .....	17
2.8	System FAN Connector (SYSFAN1) .....	17
2.9	Front Panel Connectors (JFP1) .....	18
2.9.1	ATX Soft Power Switch (JFP1/PWR_SW).....	18
2.9.2	Reset (JFP1/RESET).....	18
2.9.3	HDD LED (JFP1/HDDLED) .....	18
2.9.4	External Speaker (JFP1/SPEAKER) .....	18
2.9.5	Power LED and Keyboard Lock Connector (JFP2/PWR_LED and KEY LOCK).....	19
	Table 2.2: ATX Power Supply LED Status (AT power not supported) .....	19
2.10	Line-Out Connector (AUDIO1).....	19
2.11	Serial ATA Interface (SATA1/2).....	20
2.12	PCI-Express x1 Slot (PCIEX1_1).....	20
2.13	Front Panel Audio Connector (FP_AUDIO1) .....	21
2.14	ATX 12V Power Connector (ATX12V1).....	21
2.15	SPI Flash Connector(SPI_CN1) .....	22
2.16	LVDS Backlight Inverter Power Connector (INV1).....	22
2.17	LVDS Connector (LVDS1) .....	23
2.18	General Purpose I/O Connector (GPIO1).....	24
2.19	CMOS Battery Wafer Box (BAT1).....	24
2.20	SPI BIOS Socket (BIOS1_1).....	25
2.21	HD Digital Audio Interface (SPDIF_OUT1).....	25
2.22	Audio Amplifier Output Pin Header (JAMP1) (BOM Optional).....	26
2.23	ATX Power Supply (5VSB) Connector (ATX_5VSB1).....	26
2.24	SATA Power Connector (SATA_PWR1/2).....	27
2.25	Case Open Detect Connector (JCASE1).....	27
2.26	DDR3L SODIMM Socket (DIMM1/2) .....	28
2.27	Mini-PCIe Connector (MINI-PCIE1).....	28
2.28	M.2 E key connector (M.2_1).....	29
2.29	CMOS Clear Jumper (JCMOS1).....	29
2.30	eDP Connector (eDP1), BOM optional .....	30
2.31	eDP Backlight Inverter Power Connector (INV2), BOM optional .....	30
2.32	LAN12 LED (LANLED1).....	31

## **Chapter 3 BIOS Operation ..... 33**

3.1	Introduction .....	34
3.2	BIOS Setup .....	34
3.2.1	Main Menu .....	35
3.2.2	Advanced BIOS Features .....	36
3.2.3	Chipset.....	64
3.2.4	Security.....	77
3.2.5	Boot .....	79
3.2.6	Save and Exit.....	80

## **Chapter 4 Software and Service Introduction.. 81**

4.1	Introduction .....	82
4.2	Value-Added Software Services .....	82
4.2.1	Software API.....	82
4.2.2	Software Utility.....	84

## **Chapter 5 Chipset Software Install Utility ..... 85**

5.1	Before Installation .....	86
5.2	Introduction .....	86
<b>Chapter 6</b>	<b>Graphics Setup .....</b>	<b>87</b>
6.1	Introduction .....	88
6.2	Windows 10.....	88
<b>Chapter 7</b>	<b>LAN Configuration.....</b>	<b>89</b>
7.1	Introduction .....	90
7.2	Features .....	90
7.3	Installation .....	90
7.4	Windows 10 Driver Setup (Realtek 8111G) .....	90
<b>Appendix A</b>	<b>Pin Assignments .....</b>	<b>91</b>
A.1	Pin Assignments .....	92
	Table A.1: ATX_5VSB1 .....	92
	Table A.2: EDP1 .....	92
	Table A.3: LVDS2 .....	93
	Table A.4: INV2.....	93
	Table A.5: LVDS1 .....	94
	Table A.6: JAMP1 .....	95
	Table A.7: FP_AUDIO1.....	96
	Table A.8: INV1.....	96
	Table A.9: SPDIF_OUT1 .....	97
	Table A.10:COM1 .....	97
	Table A.11:COM2 .....	98
	Table A.12:USB0506 .....	98
	Table A.13:USB0708 .....	99
	Table A.14:COM3456 .....	99
	Table A.15:SATA_PWR1,SATA_PWR2 .....	100
	Table A.16:GPIO1.....	101
	Table A.17:SYSFAN1 .....	101
	Table A.18:JFP1 .....	102
	Table A.19:KBMS1 .....	102
	Table A.20:USB0910 .....	103
	Table A.21:USB1112 .....	103
	Table A.22:JCASE1 .....	104
	Table A.23:BAT1.....	104
	Table A.24:ATX12V1 .....	104
	Table A.25:PCIEX1_1.....	105
	Table A.26:AUDIO1 .....	106
	Table A.27:HDMI1 .....	106
	Table A.28:DP1.....	107
	Table A.29:VGA1 .....	108
	Table A.30:DCIN1 .....	108
	Table A.31:USB0102/USB0304.....	109
	Table A.32:LAN12.....	110
	Table A.33:LANLED1.....	111
	Table A.34:SATA1/SATA2.....	111
	Table A.35:MINI-PCIE1 .....	112
	Table A.36:M.2_1.....	113



# Chapter 1

General Information

## 1.1 Introduction

The AIMB-217 with Intel Pentium N4200, Celeron N3350, and Atom x7-E3950 processor is designed for industrial applications that require enhanced computing performance and power management capabilities. The motherboard features an onboard Intel® Pentium™ N4200 quad-core 1.1 GHz and Celeron N3350 dual-core 1.1 GHz and Atom x7-E3950 quad-core 1.6 GHz with DDR3L 1866 MHz up to 8GB.

The AIMB-217 offers rich I/O connectivity with four USB 3.0 and eight USB 2.0 ports (USB9/10/11/12 is BOM optional), as well as six COM ports integrated in a standard 170 x 170 mm form factor. The system also supports triple display for HDMI, VGA (or eDP), DP++ (or LVDS). AIMB-217 also features numerous connectivity and expansion options, including PCIe x1, 8-bit GPIO, two SATA III 6 GB/s connectors, an optional TPM security feature, and one MiniPCIe (with mSATA support) and one M.2 (E key for 2230 type) expansion slots for easy integration. A dual Realtek chipset and 10/100/1000 Mbps Ethernet port are also provided to deliver high-speed networking.

AIMB-217 is powered by the newest Intel® Pentium/Celeron/Atom processor, which is built on 14nm process technology. The thermal design power rating for the Intel N4200 quad-core/N3350 dual-core architecture is only 6 W, and that for Atom x7-E3950 quad-core is 12 W, allowing additional power reductions, system compressions, and performance improvements to be implemented in the future. All the features described above are incorporated into a space-saving, power-efficient, and cost-effective Mini-ITX form factor.

## 1.2 Features

- Supports Intel® Pentium N4200, Celeron N3350, and Atom x7-E3950 processors
- Two 204-pin SODIMM, up to 8 GB DDR3L 1866 MHz SDRAM
- Supports 1 PCIe x1, and 1 MiniPCIe & 1 M.2 (E key) expansion ports, six serial ports, 4 USB 3.0 & 8 USB 2.0 (USB9/10/11/12 is BOM optional), and two SATA III ports
- Lower total ownership costs with DC12V functionality; supports triple displays of HDMI, VGA (or eDP), DP++ (or LVDS)
- Onboard TPM 1.2/2.0 support (optional)
- Supports a dual-channel 6 W amplifier (optional)
- Supports embedded software APIs and utilities

## 1.3 Specifications

### 1.3.1 System

- **CPU:** Intel® Pentium N4200, Celeron N3350, and Atom x7-E3950 processors
- **BIOS:** SPI 128-Mbit BIOS
- **SATA hard disk drive interface:** Two onboard SATA connectors with a data transmission rate of up to 6 Gb/s

**Note!** *SATA2 support is only available when mSATA is not in use; SATA2 and mSATA cannot be used concurrently.*





### 1.3.2 Memory

- **RAM:** 2 x SO-DIMM DDR3L 1866 MHz up to 8 GB

**Note!** *AIMB-217 supports 1.35 V memory only. Users must install the memory module on the DIMM1 socket first.*



### 1.3.3 Input/Output

- **PCI bus:** One PCIe x1 slot, one full size MiniPCIe and one M.2 2230 (E sky) socket
- **Serial ports:** Six serial ports; COM3 comprises RS-232/422/485 and five RS-232 serial ports
- **Keyboard and PS/2 mouse connector:** Supports one standard PS/2 keyboard and one standard PS/2 mouse (onboard six-pin wafer box)
- **USB port:** Supports four USB 3.0 port with a transmission rate of up to 5Gbps and eight USB 2.0 ports with transmission rates of up to 480 Mbps. (USB9/10/11/12 is BOM optional)
- **GPIO connector:** One 8-bit general purpose input/output

**Note!** *PCIe x 1 support is only available when M.2 is not in use; M.2 and PCIe x1 cannot be used concurrently.*



### 1.3.4 Graphics

- **Controller:** Embedded Gen9
- **HDMI:** Supports a display resolution of up to 3840 x 2160 @ 30 Hz
- **DP++:** Supports a display resolution up to 4096 x 2160 @ 60 Hz; colay LVDS
- **VGA:** Supports a display resolution of up to 1920 x 1200 @ 60 Hz, colay eDP
- **LVDS:** Supports up to 1920 x 1200 @ 60 Hz, colay DP
- **eDP:** Supports up to 4096 x 2160 @ 60 Hz, colay VGA and eDP is BOM optional

### 1.3.5 Ethernet LAN

- Supports dual 10/100/1000 Mbps Ethernet port (s) via PCI Express x1 bus, which provides a data transmission rate of 500 MB/s
- **Controller:** LAN1: Realtek 8111G; LAN2: Realtek 8111G

### 1.3.6 Industrial Features

- **Watchdog timer:** Can generate a system reset. The watchdog timer is programmable, with each unit equal to one second or one minute (255 levels)

### 1.3.7 Mechanical and Environmental Specifications

- **Operating temperature:** 0 ~ 60 °C (32 ~ 140 °F, depending on the CPU)
- **Storage temperature:** -40 ~ 85 °C (-40 ~ 185 °F)
- **Humidity:** 5 ~ 95% non-condensing
- **Power supply voltage:** +12 V
- **Power consumption:** +12 V @ 1.87 A (Intel N4200 1.1 GHz processor/DDR3L 1866 MHz 4 GB x 2)
- **Board size:** 170 x 170 mm (6.69 x 6.69")
- **Board weight:** 0.365 kg

## 1.4 Jumpers and Connectors

The AIMB-217 motherboard is equipped with connectors for linking the board to external devices such as hard disk drives and a keyboard. The board also features several jumpers for configuring the system according to specific applications.

The function of each board jumper and connector is listed in the table below. The procedure for setting jumpers is explained in subsequent sections of this chapter. Instructions for connecting external devices to the motherboard are provided in Chapter 2.

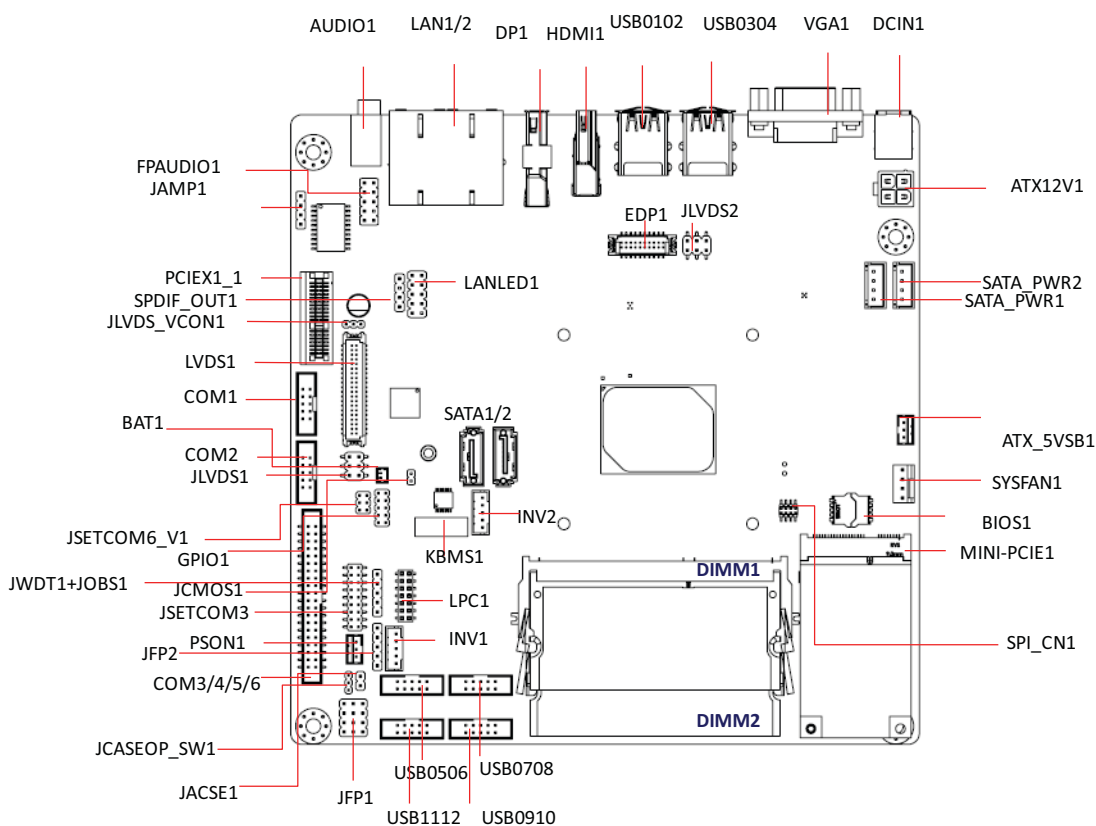
**Table 1.1: Connector / Header List**

	<b>Description</b>	<b>Part Reference</b>
1	DC-IN adaptor connector	DCIN1
2	Display Port connector	DP1
3	EDP panel POWER 3.3V/5V/12V SELECTION (optional)	JLVDS2
4	VGA connector	VGA1
5	Serial ATA interface connector	SATA2
6	Serial ATA interface connector	SATA1
7	CMOS battery wafer box	BAT1
8	USB3.0 stack connector	USB0102 &USB0304
9	SPI BIOS socket	BIOS1_1
10	COM1 box header	COM1
11	Watchdog timer output and OBS beep	JWDT1+JOBS1
12	RJ45(LAN1+LAN2) connector	LAN12
13	HD Digital Audio Interface	SPDIF_OUT1
14	HD Analog Audio Interface	AUDIO1
15	Front HD Analog Audio Interface	FP_AUDIO1
16	Audio amplifier output pin header (optional)	JAMP1
17	PCI-Express x1 slot	PCIEX1_1
18	LVDS VESA, JEIDA format selection pin header	JLVDS_VCON1
19	LVDS panel connector	LVDS1
20	Dual port USB2.0 pin header	USB0506
21	DDR3L SO-DIMM socket	DIMM1, DIMM2
22	LVDS1 panel power 3.3V/5V/12V selection	JLVDS1
23	COM6 RI# selection pin header	JSETCOM6_V1
24	LVDS Backlight inverter power connector	INV1
25	8-bits General Purpose I/O pin header	GPIO1
26	COM3 ~ COM6 box header	COM3456
27	AT/ATX Mode selection	PSON1
28	ATX Power supply(5VSB) connector	ATX_5VSB1
29	COM3 RS232,RS422,RS485 selection pin header	JSETCOM3
30	SATA power connector	SATA_PWR1
31	COM2 box header	COM2
32	System fan connector	SYSFAN1
33	Case open selection pin header	JCASEOP_SW1
34	Case-Open Detect Connector	JCASE1
35	PS/2 keyboard and PS/2 mouse connector	KBMS1
36	MINIPCI connector	MINI-PCIE1

**Table 1.1: Connector / Header List**

37	M.2 E key connector	M.2_1
38	Low pin count interface header	LPC1
39	SPI Programming Pin Header	SPI_CN1
40	CMOS Clear Jumper	JCMOS1
41	SATA Power connector	SATA_PWR2
42	Dual port USB2.0 pin header	USB0708
43	Dual port USB2.0 pin header (optional)	USB0910
44	Dual port USB2.0 pin header (optional)	USB1112
45	eDP connector (optional)	eDP1
46	Power LED and keyboard lock pin header	JFP2
47	Power switch/HDD LED/SMBus/Speaker pin header	JFP1
48	eDP Backlight inverter power connector (optional)	INV2
49	ATX 12V power supply connector	ATX12V1

## 1.5 Board Layout: Jumper and Connector Locations

**Figure 1.1 Jumper and Connector Locations**

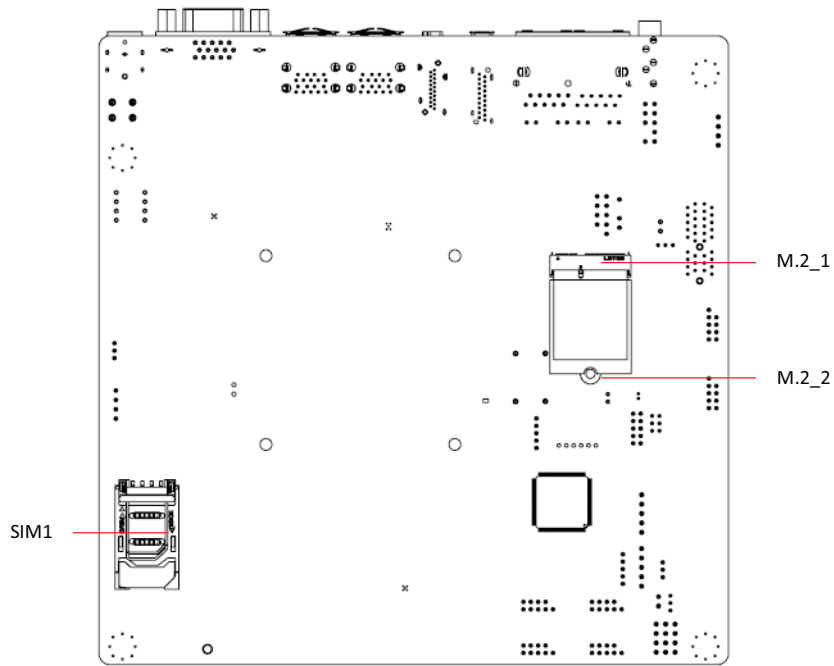


Figure 1.2 I/O Connectors

## 1.6 AIMB-217 Board Diagram

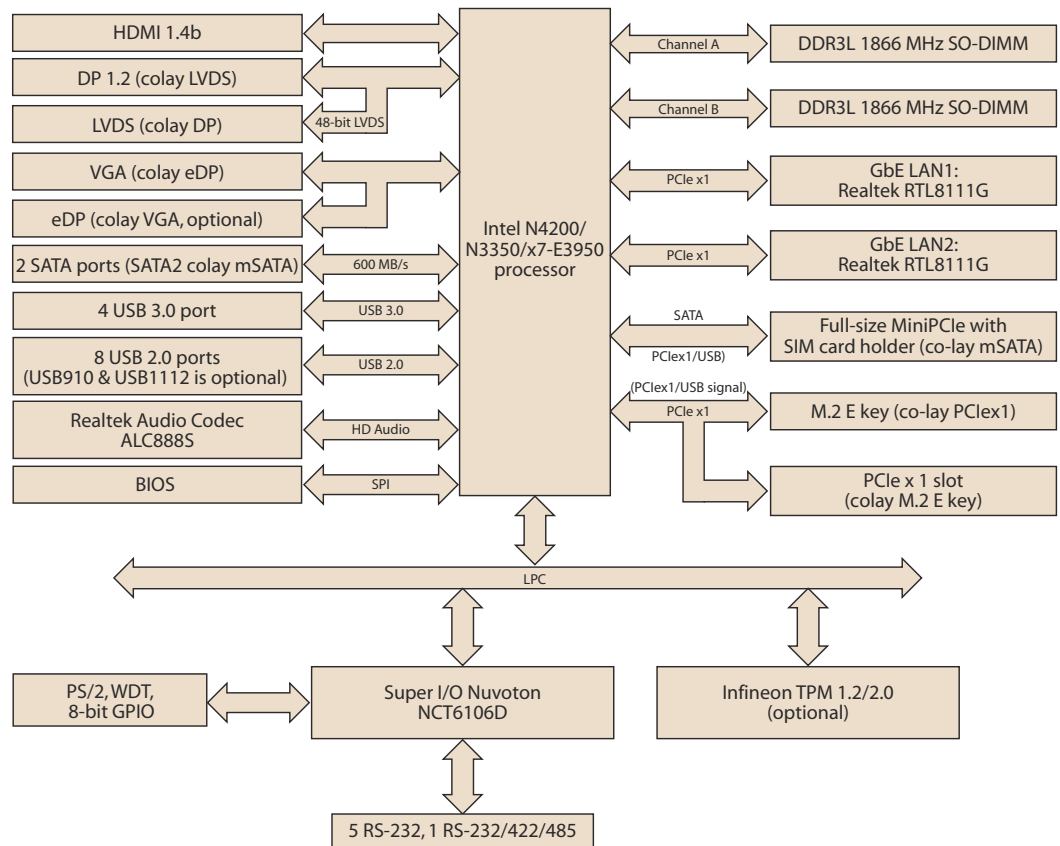


Figure 1.3 AIMB-217 Board Diagram

## 1.7 Safety Precautions

**Warning!** *Always completely disconnect the power cord from the chassis when working with the hardware. Do not connect devices while the power is on. Sensitive electronic components can be damaged by sudden power surges. Only experienced electronics personnel should open the PC chassis.*



**Caution!** *Always ground yourself to remove any static charge before touching the motherboard. Modern electronic devices are very sensitive to electrostatic discharges. As a safety precaution, use a grounding wrist strap at all times. Place all electronic components on a static-dissipative surface or in a static-shielded bag when not in the chassis.*



**Caution!** *The computer is provided with a battery-powered real-time clock circuit. There is a danger of explosion if the battery is incorrectly replaced. Replace only with the same or equivalent type recommended by the manufacturer. Discard used batteries according to the manufacturer's instructions.*



**Caution!** *There is a danger of a new battery exploding if incorrectly installed. Do not attempt to recharge, force open, or heat the battery. Replace the battery only with the same or equivalent type recommended by the manufacturer. Discard used batteries according to the manufacturer's instructions.*



## 1.8 Jumper Options

This section provides instructions on how to configure the motherboard by setting jumpers, and also outlines the default motherboard settings and options for each jumper.



### 1.8.1 Setting Jumpers

The motherboard can be configured according to the application requirements with the setting of jumpers. A jumper is a metal bridge used to close an electrical circuit. Jumpers typically consist of two metal pins and a small metal clip (often protected by a plastic cover) that slides over the pins to connect them. To “close” (or turn ON) a jumper, connect the pins with the clip. To “open” (or turn OFF) a jumper, simply remove the clip. Some jumpers comprise a set of three pins, labeled 1, 2, and 3. With these jumpers, simply connect either Pins 1 and 2, or Pins 2 and 3. A pair of needle-nose pliers may be necessary for setting jumpers.

## 1.8.2 CMOS Mode Selection (JCMOS1)

The AIMB-217 motherboard contains a jumper that can erase CMOS data and reset the system BIOS information. To reset the CMOS data, Put jumper to Pins 1 & 2 as closed for a few seconds. This procedure resets the CMOS to its default settings.

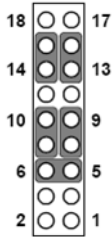
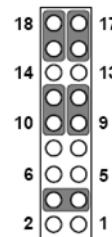
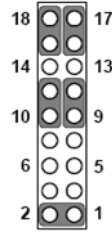
**Table 1.2: CMOS Mode Selection (JCMOS1)**

Function	Setting
Normal (Default)	 1
Clear CMOS	 1

## 1.8.3 COM3 RS-232/422/485 Mode Selector (JSETCOM3)

Users can select between the RS-232/422/485 modes for COM3 using JSETCOM3. The default setting is "RS-232".

**Table 1.3: COM3 RS-232/422/485 Mode Selector (JSETCOM3)**

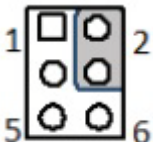
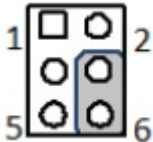
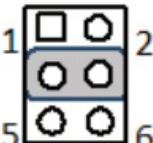
Function	Setting
Set COM3 as RS-232 (default)	
Set COM3 as RS-422	
Set COM3 as RS-485	

**Table 1.4: COM3 RS-232/422/485 Mode Selector (JSETCOM3)**

Function	Jumper Settings
RS-232*	(5-6) + (7-9) + (8-10) + (13-15) + (14-16) closed
RS-422	(3-4) + (9-11) + (10-12) + (15-17) + (16-18) closed
RS-485	(1-2) + (9-11) + (10-12) + (15-17) + (16-18) closed
*default	

### 1.8.4 LVDS/eDP Panel Voltage Selection (JLVDS1/JLVDS2), eDP is BOM optional

**Table 1.5: LVDS/eDP panel voltage selection (JLVDS1/JLVDS2)**

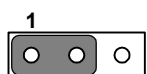
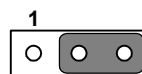
Function	Setting
Set LVDS Panel as +5V (2-4)	
Set LVDS Panel as +3.3V (Default) (4-6)	
Set LVDS Panel as +12V (3-4)	

### 1.8.5 PSON1: ATX and AT Mode Selector

**Table 1.6: PSON1: ATX and AT Mode Selector**

Closed Pins	Result
1-2	AT Mode
2-3*	ATX Mode

\*Default



AT Mode  
1-2 closedATX Mode  
2-3 closed

## 1.8.6 JWDT1 + JOBS1: Watchdog Timer Output and OBS Beep

**Table 1.7: JWDT1 + JOBS1: Watchdog Timer Output and OBS Beep**


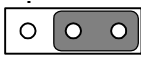
Closed Pins	Result
2-3*	Watchdog reset
4-5*	OBS alarm

\*default

Function	Settings
Watchdog Timer Output (2-3) (default) OBS BEEP (4-5) (default)	<p>1 2 3 4 5</p> 
Watchdog Timer disabled (1-2) OBS BEEP (4-5) (default)	<p>1 2 3 4 5</p> 

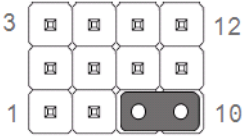
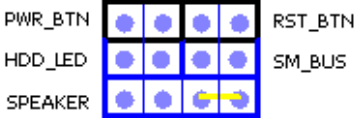
## 1.8.7 Case Open Pin Header Selection (JCASEOP\_SW1)

**Table 1.8: Case Open Pin Header Selection (JCASEOP\_SW1)**

Function	Settings
Normal Close	<p>1 2 3</p> 
Normal Open (default)	<p>1 2 3</p> 

## 1.8.8 Power Switch/HDD LED/SMBus/Speaker Pin Header (JFP1)

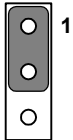
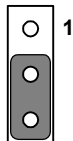
**Table 1.9: Power Switch/HDD LED/SMBus/Speaker Pin Header (JFP1)**

Function	Settings
JFP1 (7-10) (default)	 



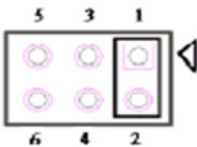
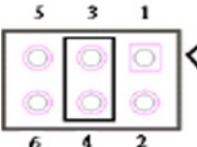
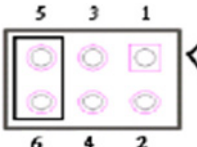
### 1.8.9 JEIDA/VESA Selection (JLVDS\_VCON1)

**Table 1.10: JEIDA/VESA Selection (JLVDS\_VCON1)**

Function	Settings
Pull high to +3.3V (JEIDA or VESA base on panel definition)	
Pull down to GND (default) (JEIDA or VESA base on panel definition)	



### 1.8.10 COM6 5V/12V selection (JSETCOM6\_V1)

**Table 1.11: COM6 5V/12V selection (JSETCOM6\_V1)**

Function	Settings
Set COM6_RI# as Ring (Default)	
Set COM6_RI# as 5V	
Set COM6_RI# as 12V	

## 1.8.11 Power LED and PS2 keyboard control (JFP2)

**Table 1.12: Power LED and PS2 keyboard control (JFP2)**

Function	Setting
1-3: For power LED (Pin1: Anode, Pin3: Cathode)	
4-5: Enable PS2 keyboard	

# Chapter 2

Connecting  
Peripherals

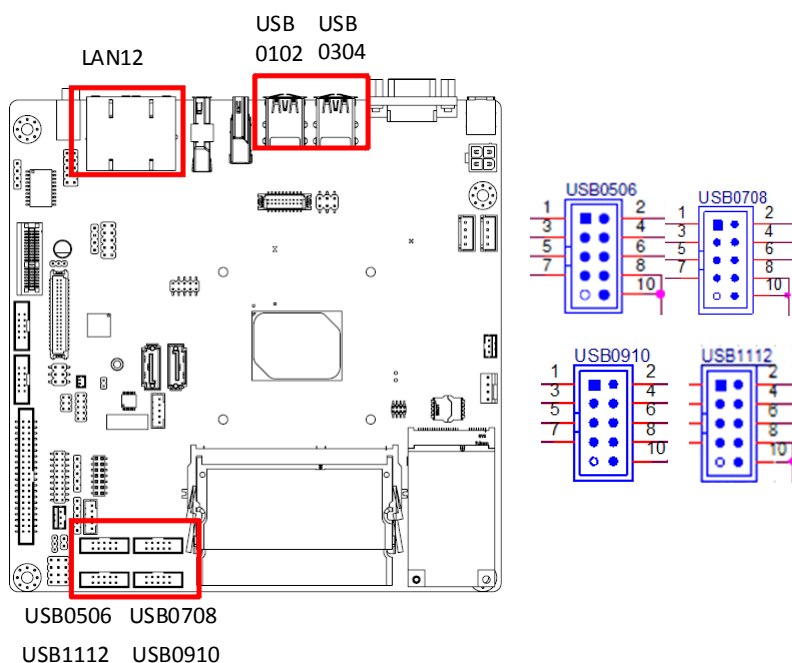
## 2.1 Introduction

Most of the device connectors can be accessed from the top of the board during installation in the chassis. If the system is installed with several cards or the chassis is packed, partial removal of the card may be necessary to make all connections.

## 2.2 LAN and USB Ports

AIMB-217 provides up to four USB 3.0 and eight USB 2.0 ports. (LAN1/2, USB0102/USB0304/USB0506/USB0708/USB0910/USB1112, USB0910 & USB1112 is BOM optional). Four USB 3.0 are located on the rear side, and eight USB 2.0 are located internally. The USB interface complies with the USB specification revision 2.0 that supports transmission rates of up to 480 Mbps, revision 3.0 that supports transmission rates of up to 5 Gbps, and is also fuse protected. Furthermore, the USB interface can be disabled in the system BIOS setup menu.

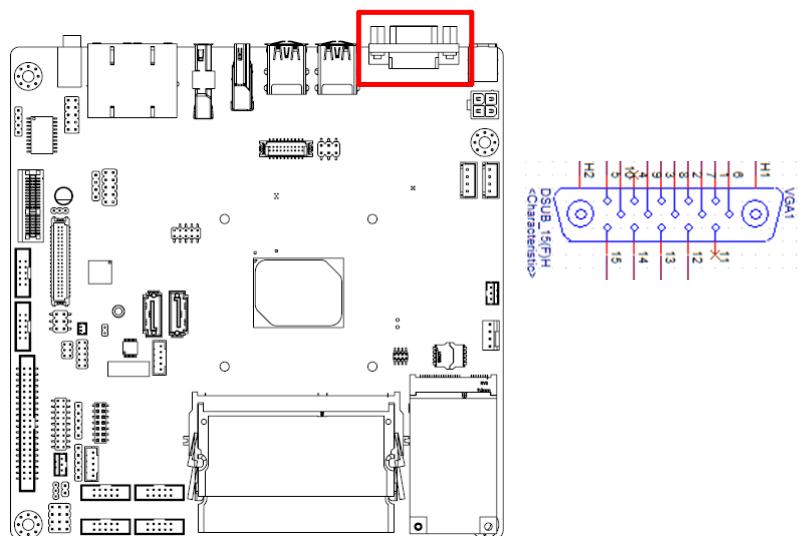
The AIMB-217 system is equipped with two high-performance 1000 Mbps Ethernet LAN adapters, both of which are supported by all major network operating systems. The RJ-45 jacks on the rear panel facilitate convenient LAN connection.



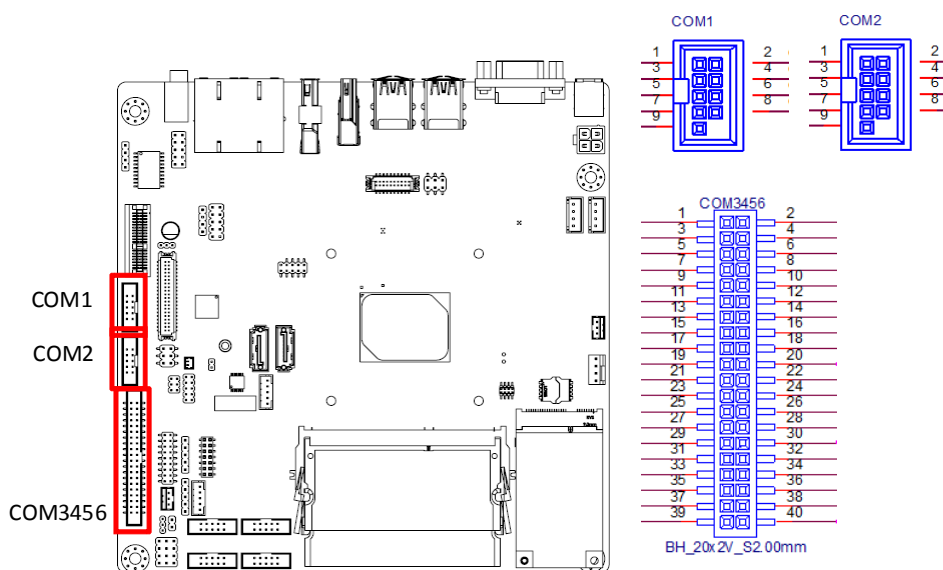
**Table 2.1: LAN LED Indicators**

LAN Mode	LAN Indicator
1 Gbps link on	LED1 Green on
100 Mbps link on	LED1 Orange on
Active	LED2 Green flashing

## 2.3 VGA Connector (VGA1)

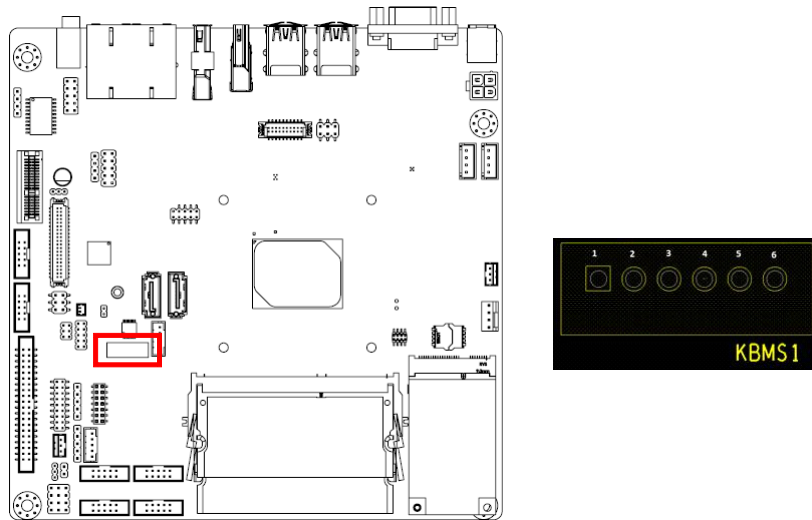


## 2.4 Serial Ports (COM1 ~ COM6)



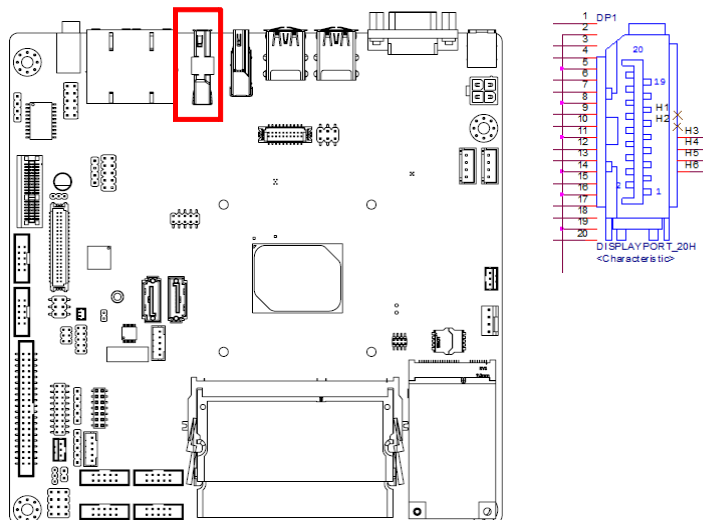
AIMB-217 supports six serial ports. COM3 is RS-232/422/485 and COM1/2/4/5/6 are RS-232. COM6 also supports 5 V/12 V according to jumper selection. Users can employ JSETCOM3 to select between the RS-232/422/485 modes for COM3. Such ports can be connected to serial devices, such as a mouse or printer, or to a communications network. The IRQ and address ranges for both ports are fixed. However, users can disable the port or change the parameters via the system BIOS setup. Various devices implement the RS-232/422/485 standards in different manners. Users who experience problems with a serial device are advised check the connector pin assignments.

## 2.5 PS/2 Keyboard and Mouse Connector (KBMS1)

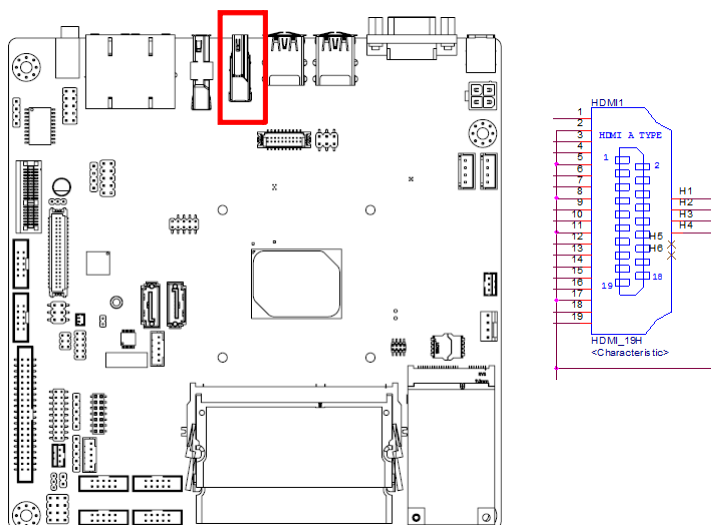


Onboard six-pin wafer box connector, which supports one standard PS/2 keyboard and one standard PS/2 mouse.

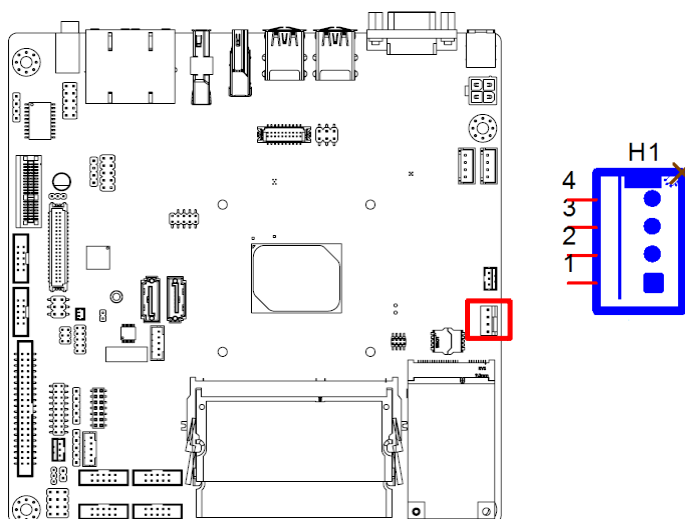
## 2.6 Display Port Connector (DP1)



## 2.7 HDMI connector (HDMI1)



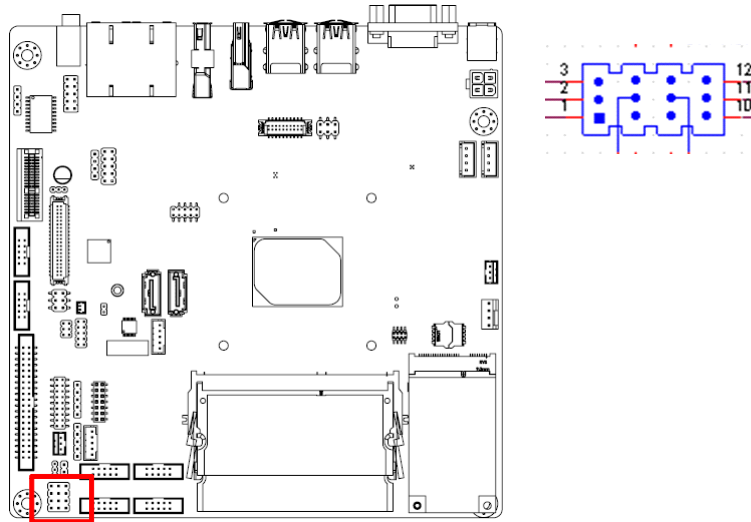
## 2.8 System FAN Connector (SYSFAN1)



For devices with a fan installed, this connector supports cooling fans of up to 500 mA (6 W).

## 2.9 Front Panel Connectors (JFP1)

Several external switches are provided for monitoring and controlling the AIMB-217.



### 2.9.1 ATX Soft Power Switch (JFP1/PWR\_SW)

For computer cases equipped with ATX power supply, users should connect the Power On/Off button on the computer case to (JFP1 + JFP2/PWR\_SW) for convenient Power On/Off functionality.

### 2.9.2 Reset (JFP1/RESET)

Many computer cases offer the convenience of a specific reset button. Connect the wire for the reset button.

### 2.9.3 HDD LED (JFP1/HDDLED)

An LED can be linked to the connector (JFP2/HDDLED) to indicate when the HDD is active.

### 2.9.4 External Speaker (JFP1/SPEAKER)

(JFP1/SPEAKER) is a four-pin connector for an external speaker. If no external speaker is available, the AIMB-217 provides an onboard buzzer as an alternative. To enable the buzzer, set Pins 7-10 as closed.



## 2.9.5 Power LED and Keyboard Lock Connector (JFP2/PWR\_LED and KEY LOCK)

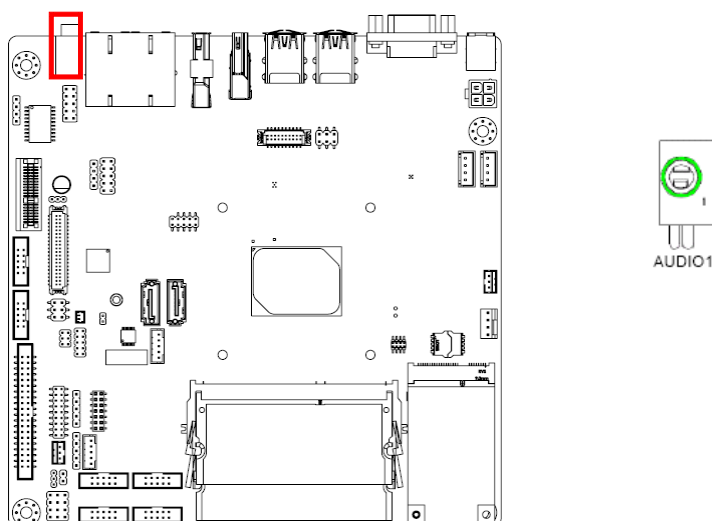
(JFP2/PWR\_LED and KEY LOCK) is a five-pin connector for the Power-On LED and Key Lock function. Refer to Appendix B for detailed information regarding the pin assignments. The Power LED cable should be connected to Pins 1-3. The key lock button cable should be connected to Pins 4 and 5.

Three power supply connection modes exist. The first is the ATX power mode, where the system is powered on/off by momentarily pressing the power button. The second is the AT power mode, where the system is powered on/off using the power supply switch. The third is another AT power mode that involves the front panel power switch. The status differences indicated by the power LED are listed in the following table:

**Table 2.2: ATX Power Supply LED Status (AT power not supported)**

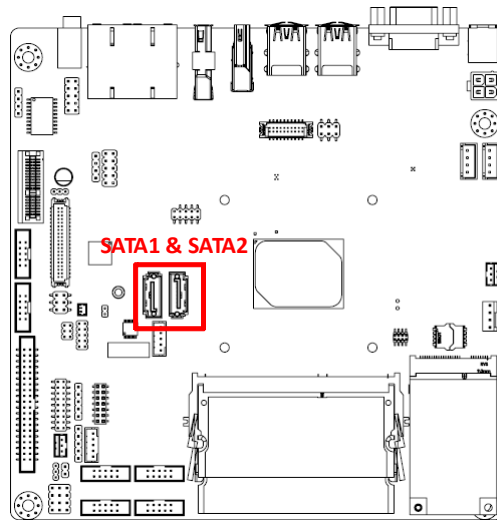
Power mode	LED (ATX power mode) (On/off by momentarily pressing the power button)	LED (AT power mode) (Powered on/off using the power supply switch)	LED (AT power mode) (Powered on/off using the front panel switch)
PSON1 (on the back plane) jumper setting	Pins 2-3 closed	Pins 1-2 closed	Connect Pins 1 and 2 to the panel switch via cable
System On	On	On	On
S3	Fast flashing	N/A	N/A
S4	Slow flashing	N/A	N/A
System Off	Off	Off	Off

## 2.10 Line-Out Connector (AUDIO1)



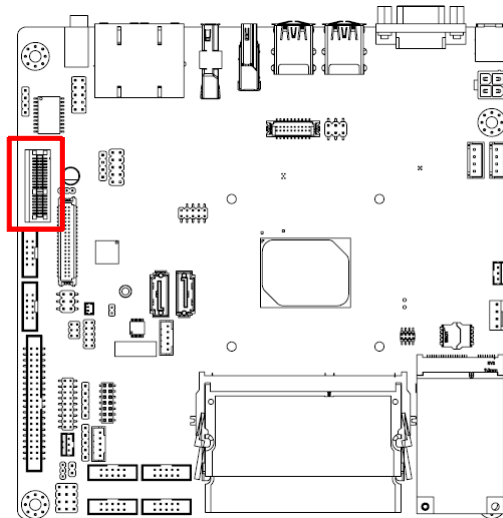
This connector supports line-out, mic-in, and line-in functions. (Default: line-out)

## 2.11 Serial ATA Interface (SATA1/2)



AIMB-217 features a high-performance Serial ATA interface (up to 600 MB/s) that allows cabling to hard drives using long, thin cables.

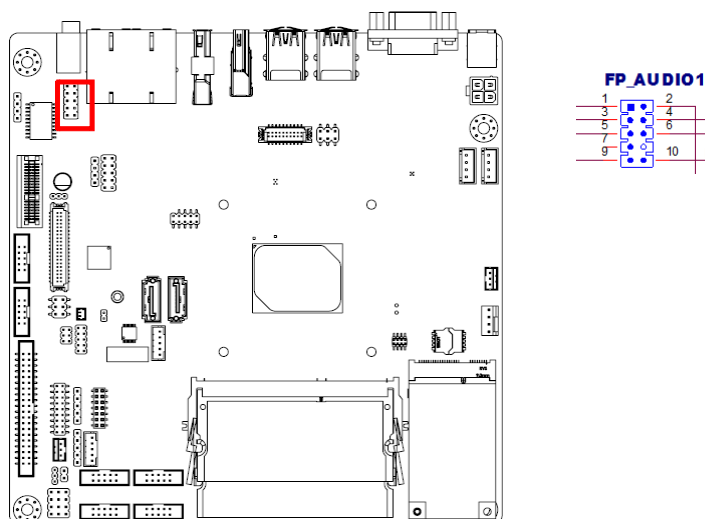
## 2.12 PCI-Express x1 Slot (PCIEX1\_1)



The AIMB-217 features one PCIe x1 slot.

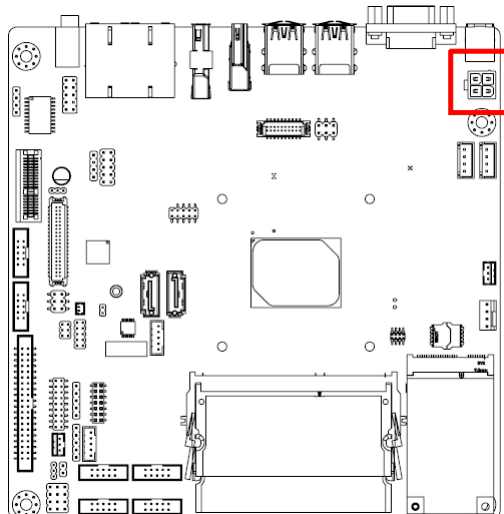
## 2.13 Front Panel Audio Connector (FP\_AUDIO1)

This connector is for a chassis-mounted front-panel audio I/O module that supports HD audio. This connector is attached using the front panel audio I/O module cable.



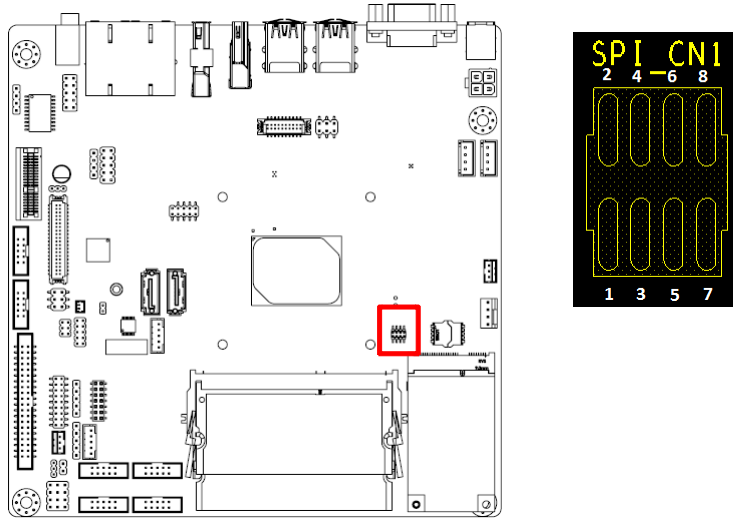
## 2.14 ATX 12V Power Connector (ATX12V1)

This connector is for an ATX Micro-Fit power supply. The plugs from the power supply are designed to fit these connectors in only one direction. Determine the correct orientation and press firmly until the connectors mate completely.

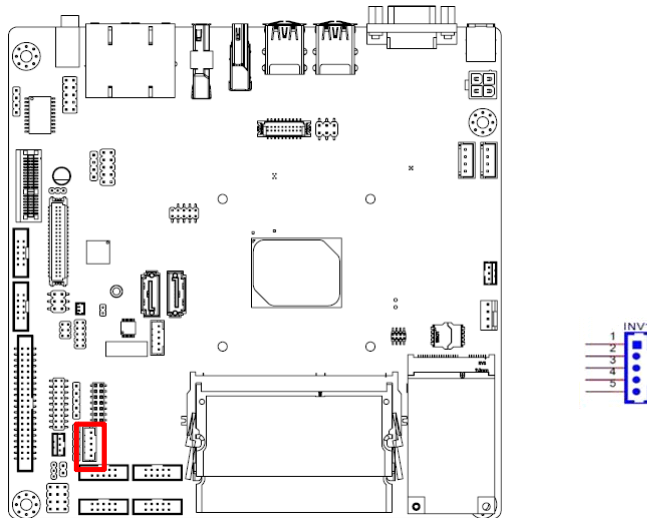


## 2.15 SPI Flash Connector(SPI\_CN1)

The SPI flash card pin header may be used to flash the BIOS if the AIMB-217 cannot be powered on.



## 2.16 LVDS Backlight Inverter Power Connector (INV1)



**Note!**



■ **Signal Description**

**Signal**

VR

ENBKL

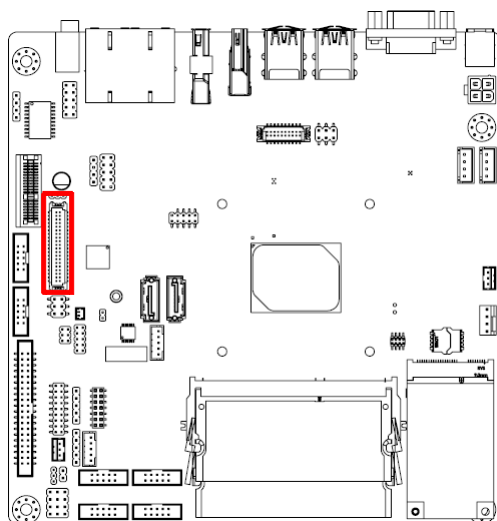
**Signal Description**

Vadj=0.75 V

(Recommended: 4.7 KΩ, >1/16 W)

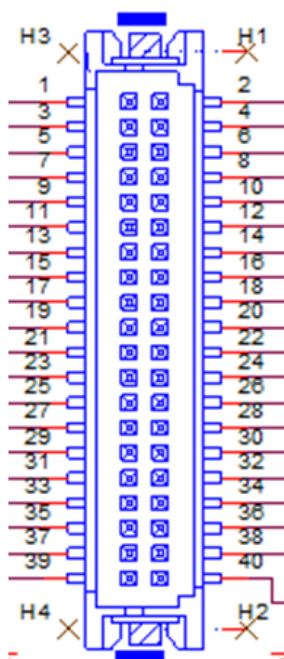
LCD backlight ON/OFF control signal

## 2.17 LVDS Connector (LVDS1)

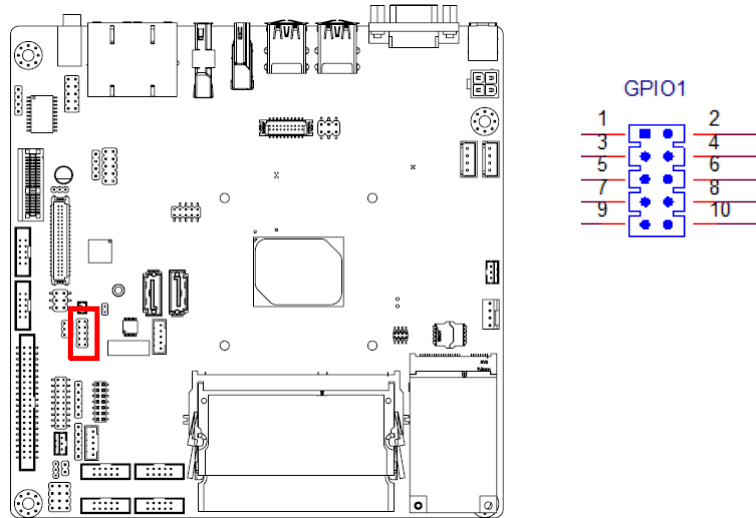


Pin 3 : GND →  
Panel connected.

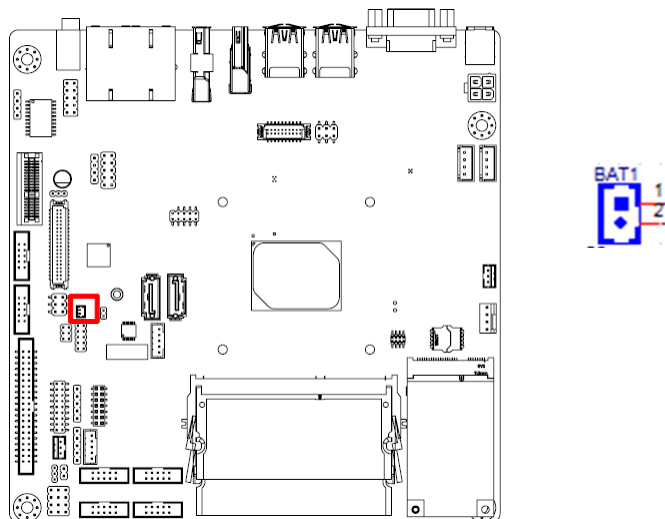
NC / 3.3V → No panel.



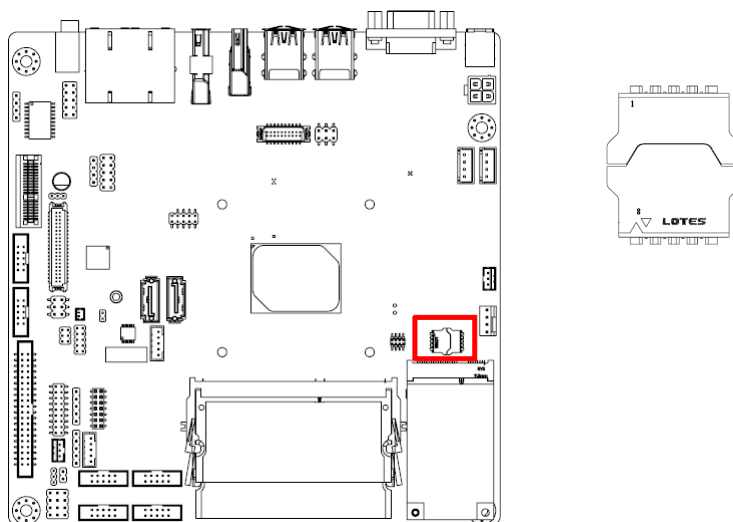
## 2.18 General Purpose I/O Connector (GPIO1)



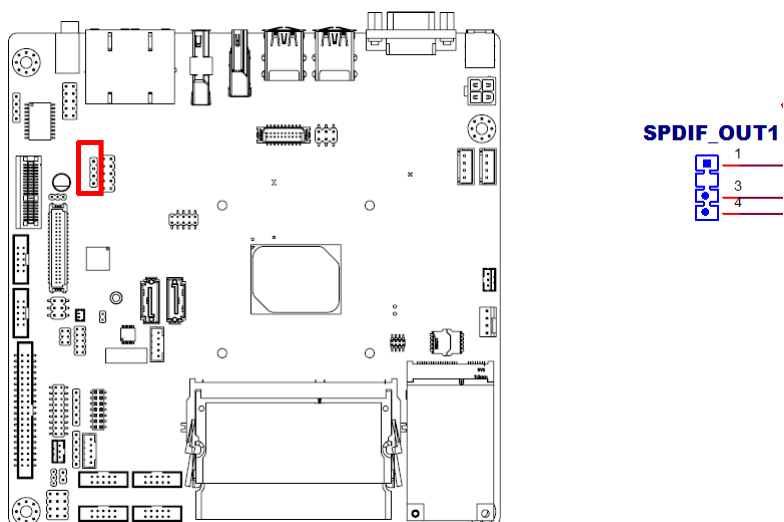
## 2.19 CMOS Battery Wafer Box (BAT1)



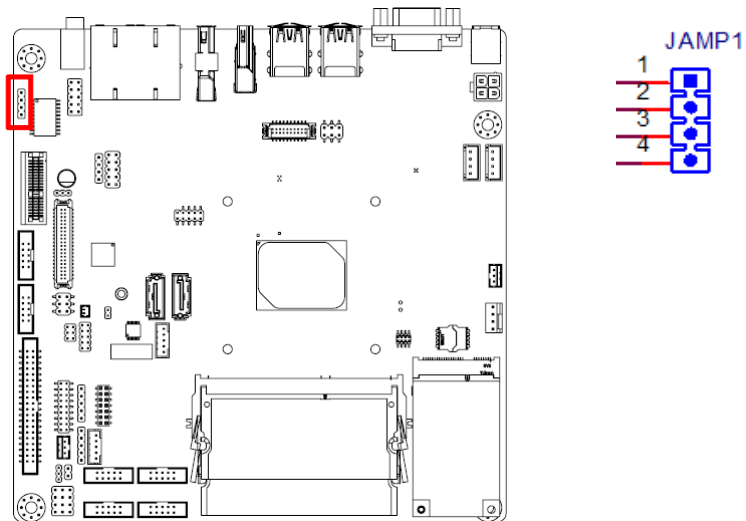
## 2.20 SPI BIOS Socket (BIOS1\_1)



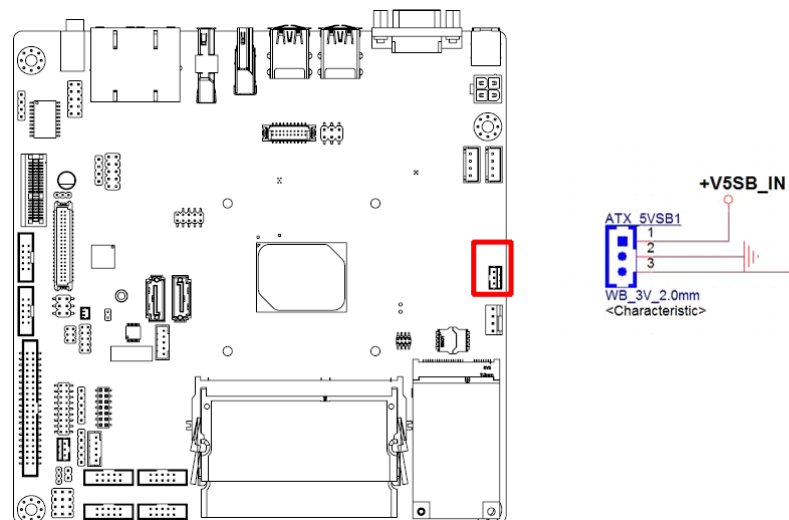
## 2.21 HD Digital Audio Interface (SPDIF\_OUT1)



## 2.22 Audio Amplifier Output Pin Header (JAMP1) (BOM Optional)

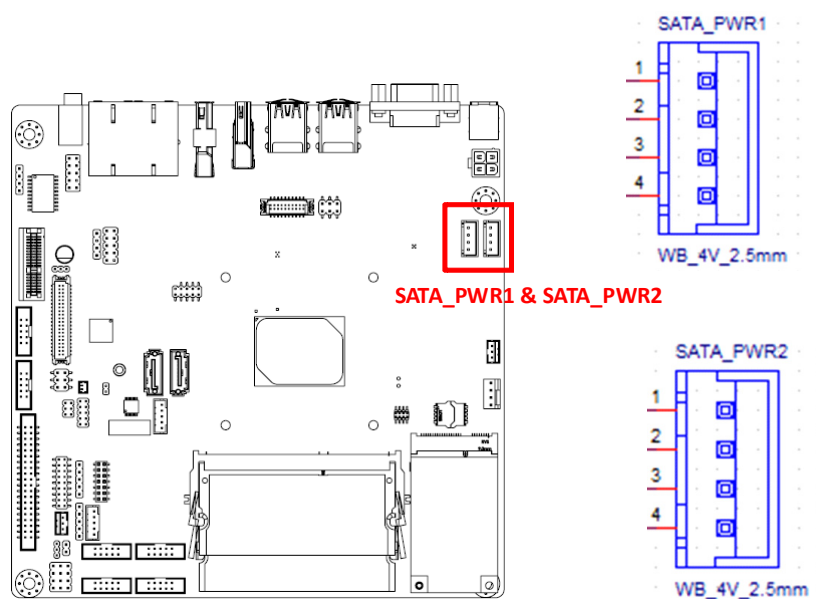


## 2.23 ATX Power Supply (5VSB) Connector (ATX\_5VSB1)

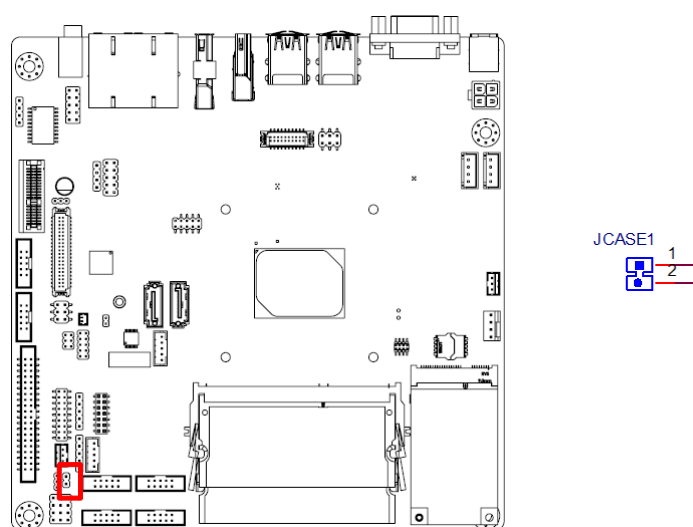




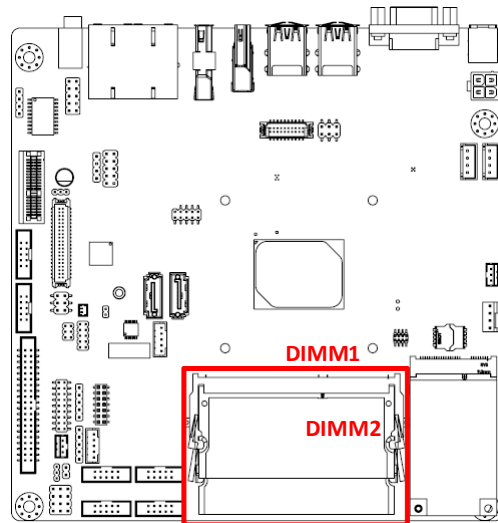
## 2.24 SATA Power Connector (SATA\_PWR1/2)



## 2.25 Case Open Detect Connector (JCASE1)



## 2.26 DDR3L SODIMM Socket (DIMM1/2)

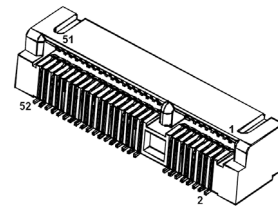
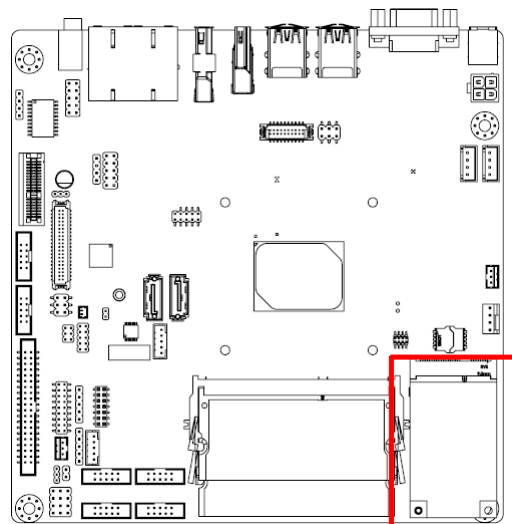


**Note!** AIMB-217 supports 1.35 V memory only. Users must populate the memory on socket DIMM1 first.

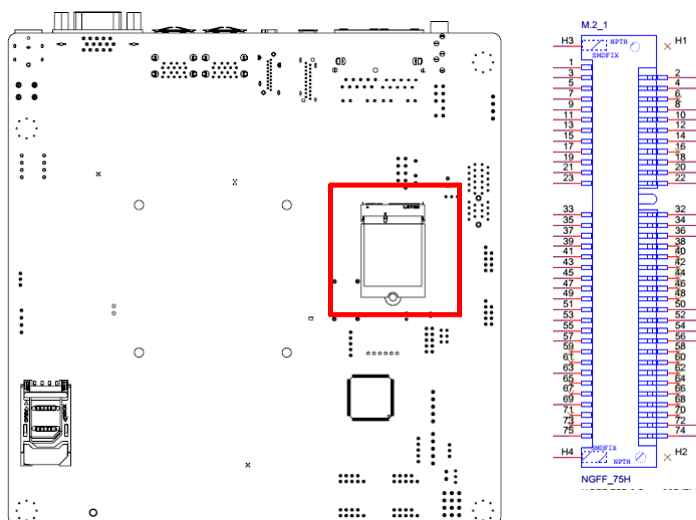


Users are advised to use memory modules of the same type, speed, and frequency for each motherboard. Memory modules of different types and speeds should not be used.

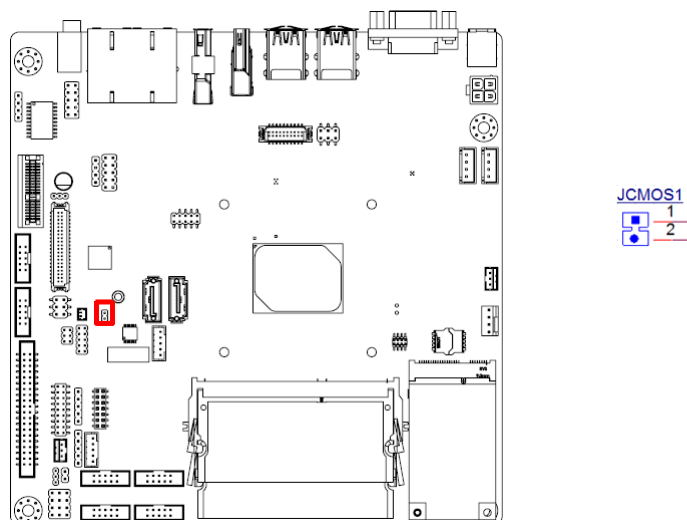
## 2.27 Mini-PCIe Connector (MINI-PCIE1)



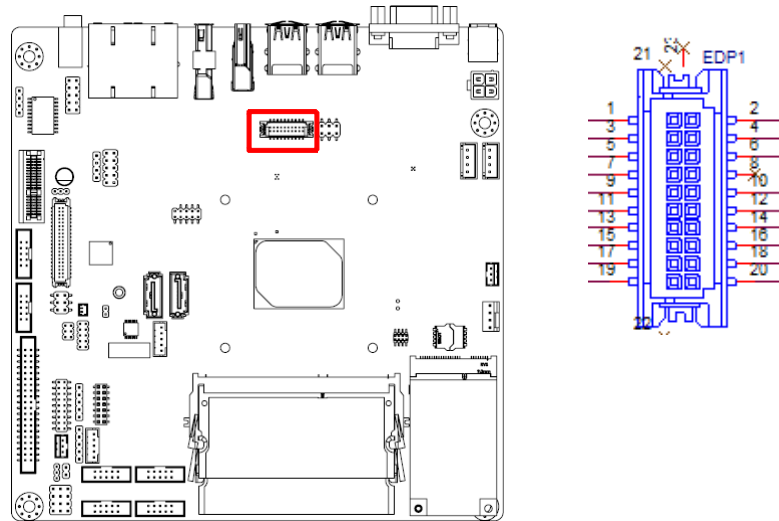
## 2.28 M.2 E key connector (M.2\_1)



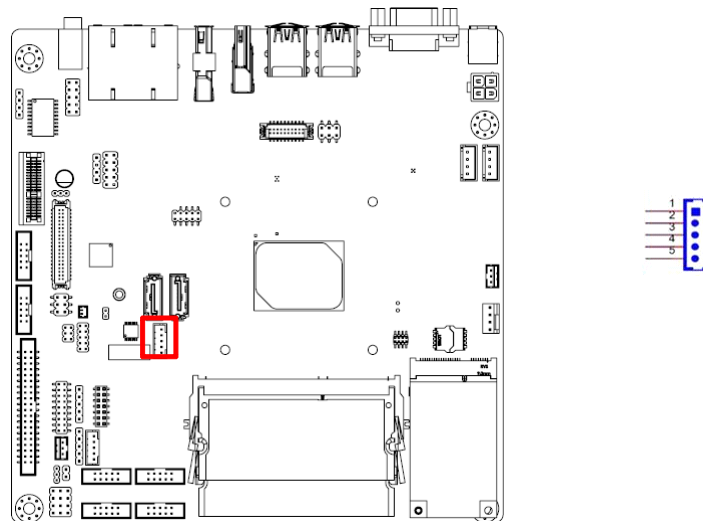
## 2.29 CMOS Clear Jumper (JCMOS1)



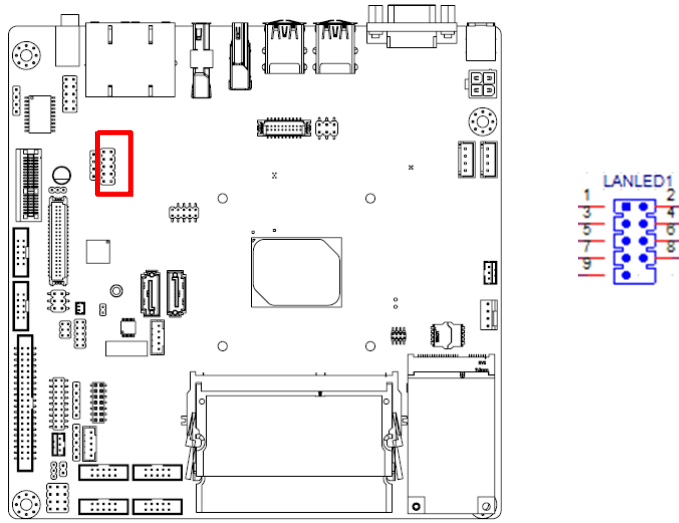
## 2.30 eDP Connector (eDP1), BOM optional



## 2.31 eDP Backlight Inverter Power Connector (INV2), BOM optional



## 2.32 LAN12 LED (LANLED1)





# Chapter 3

BIOS Operation

## 3.1 Introduction

With the AMI BIOS Setup program, users can modify the BIOS settings and control the special system features. The Setup program comprises several menus with options for adjusting or turning special features on or off. This chapter describes the basic navigation of the AIMB-217 BIOS setup menu pages.

## 3.2 BIOS Setup

The AIMB-217 Series is equipped with built-in AMI BIOS and a CMOS Setup Utility that allows users to configure specific settings or activate certain system features.

The CMOS Setup Utility saves the configuration in the CMOS RAM of the motherboard. When the system power is turned off, the battery on the board supplies the necessary power to preserve the CMOS RAM.

When the power is turned on, press the <Del> button during the BIOS power-on self-test (POST) to access the CMOS Setup Utility screen.

---

### Control Keys

---

< ↑ >< ↓ >< ← >< → >	Move select item
----------------------	------------------

---

<Enter>	Select item
---------	-------------

---

<Esc>	Main Menu - Quit without saving changes to the CMOS Sub Menu - Exit current page and return to the Main Menu
-------	---

---

<Page Up/+>	Increase the numeric value or make changes
-------------	--

---

<Page Down/->	Decrease the numeric value or make changes
---------------	--

---

<F1>	General help, for Setup Sub Menu
------	----------------------------------

---

<F2>	Item help
------	-----------

---

<F5>	Load previous values
------	----------------------

---

<F7>	Load setup defaults
------	---------------------

---

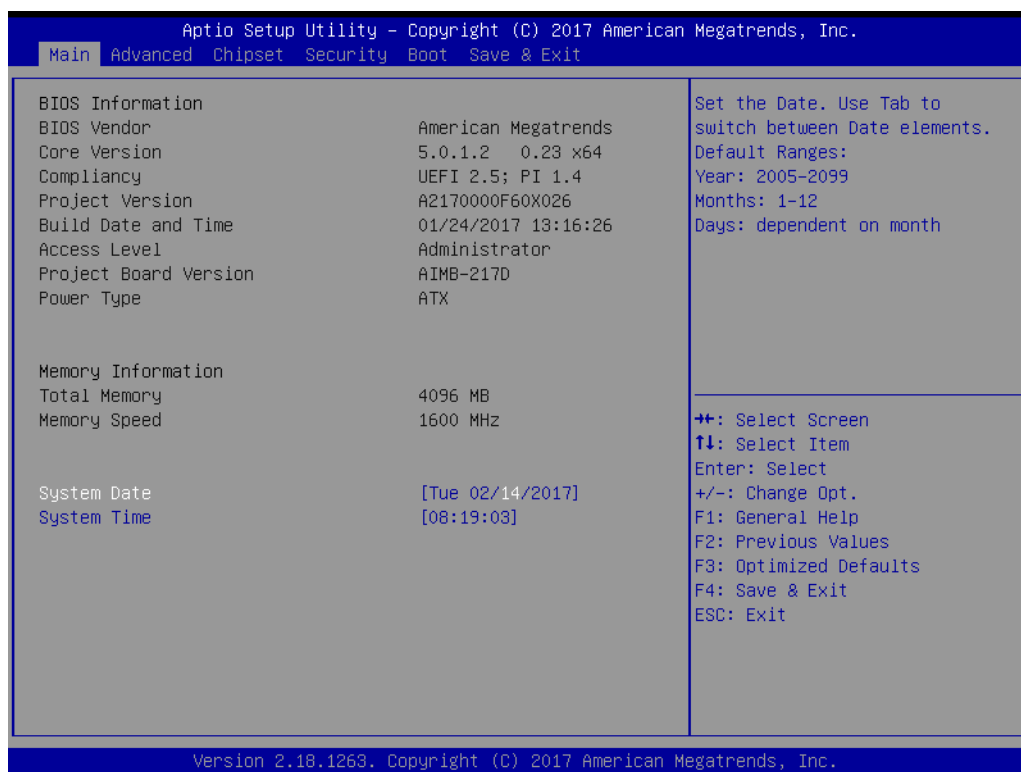
<F10>	Save all CMOS changes
-------	-----------------------

---



### 3.2.1 Main Menu

Press <Del> to enter the AMI BIOS CMOS Setup Utility, the Main Menu will appear on the screen. Use the arrow keys to select items and press <Enter> to access the submenu.



The Main BIOS setup screen has two main frames. The left frame displays all the options that can be configured. Grayed-out options cannot be configured; options in blue can. The right frame displays the key legend.

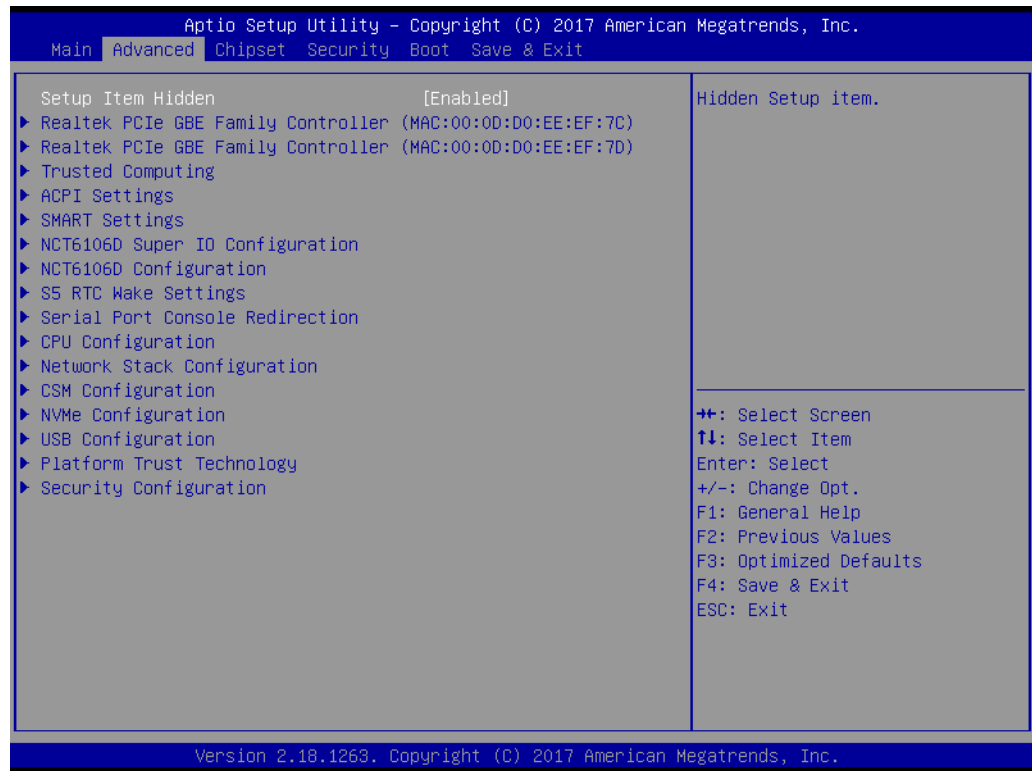
Above the key legend is an area reserved for a text message. When an option is selected in the left frame, it is highlighted in white. Often a text message will accompany it.

#### ■ System Time/System Date

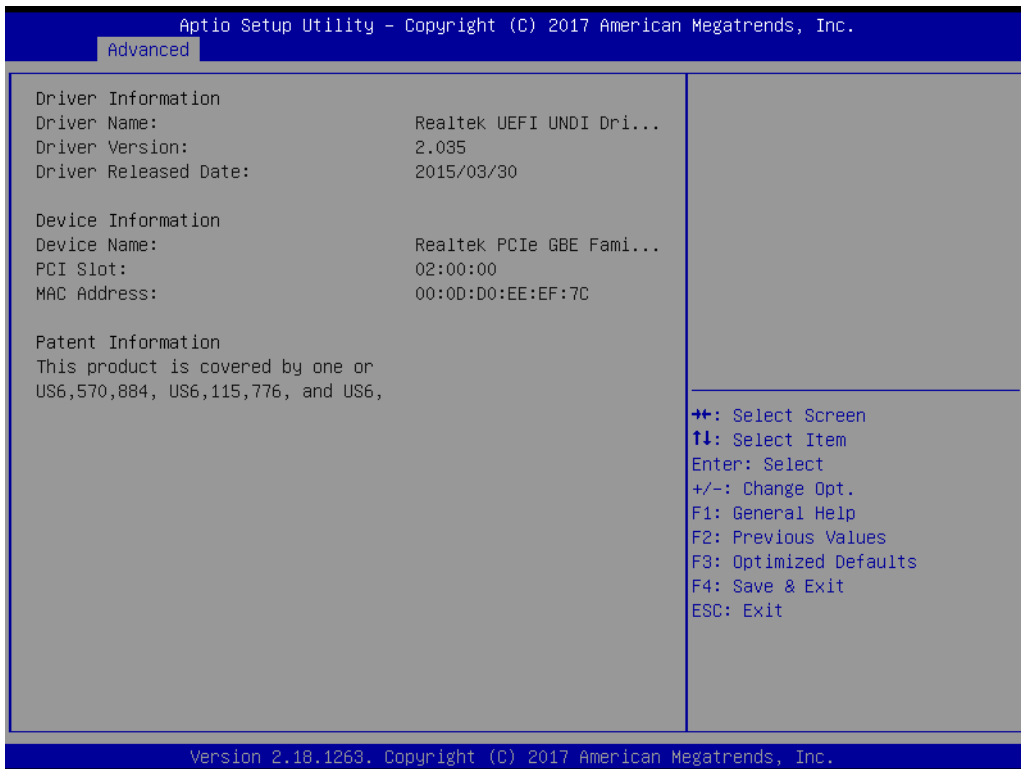
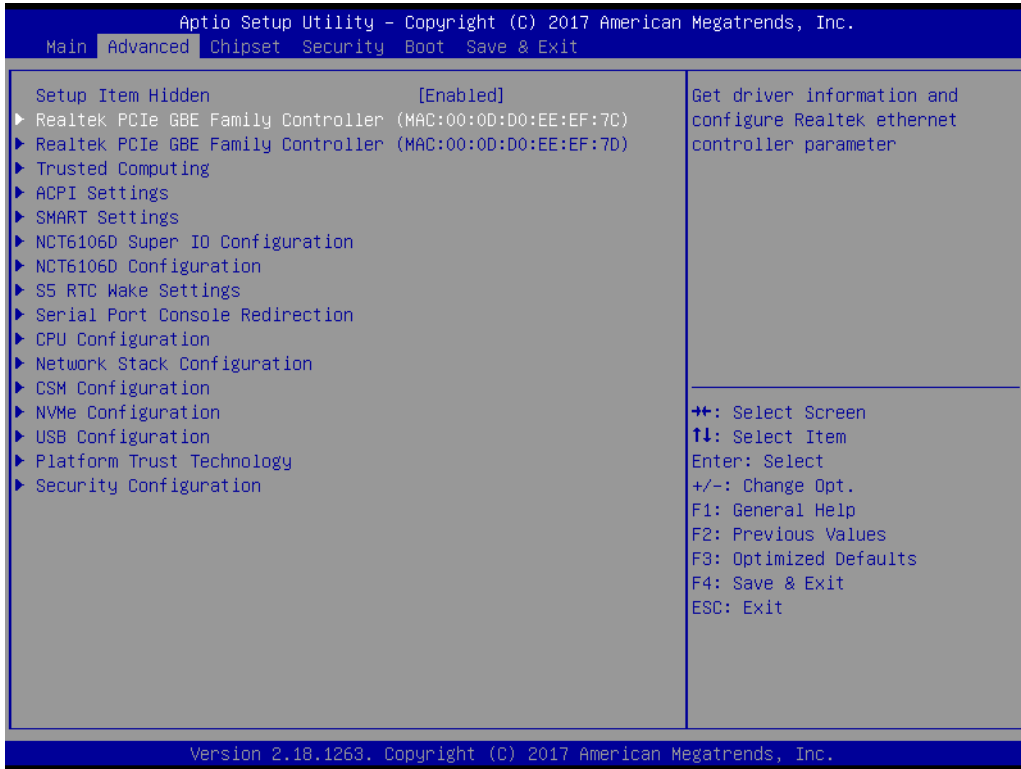
Use this option to change the system time and date. Highlight the System Time or System Date using the <Arrow> keys. Enter new values via the keyboard. Press the <Tab> or <Arrow> keys to move between fields. The date must be entered in MM/DD/YY format. The time must be entered in HH:MM:SS format.

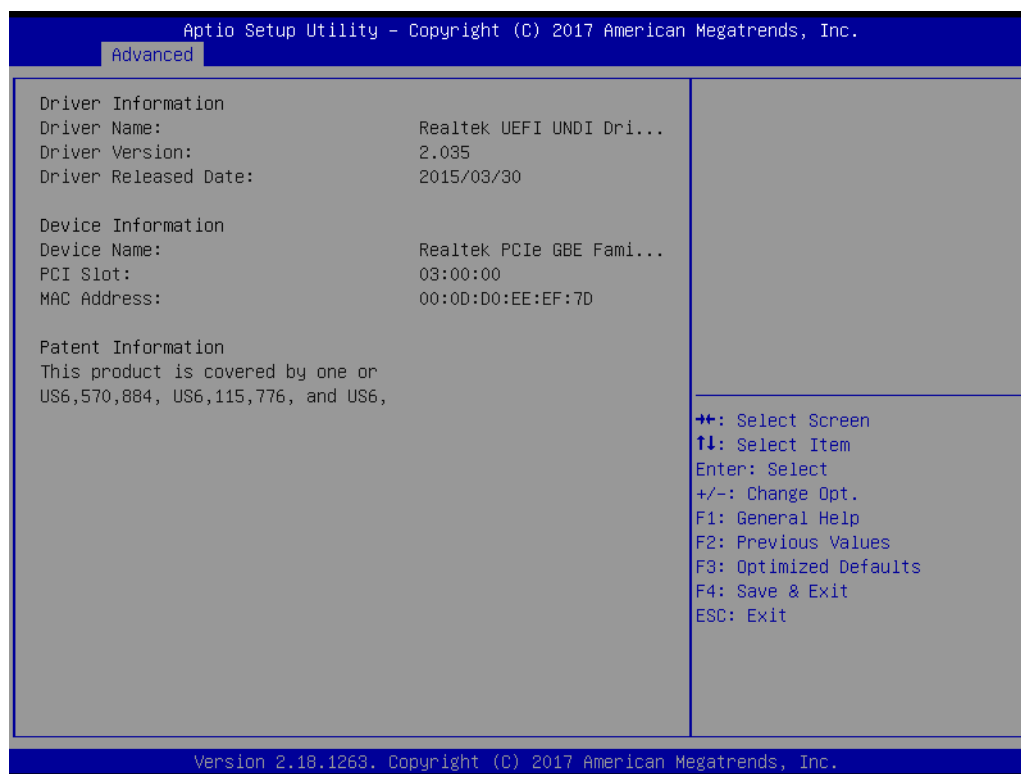
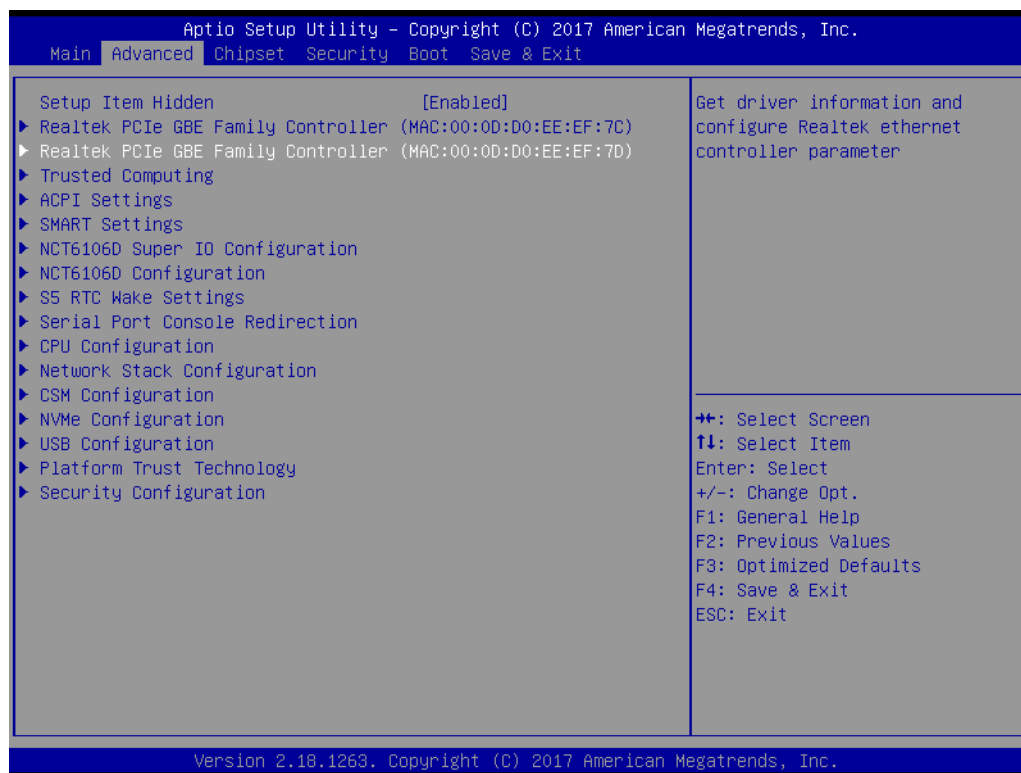
### 3.2.2 Advanced BIOS Features

Select the Advanced tab from the AIMB-217 Setup menu to enter the Advanced BIOS Setup page. Users can select any item in the left frame of the screen, such as CPU Configuration, to access the submenu for that item. Select an Advanced BIOS Setup option by highlighting the text using the <Arrow> keys. All Advanced BIOS Setup options are described in this section. The Advanced BIOS Setup menu screen is shown below. The submenus are described in the following pages.

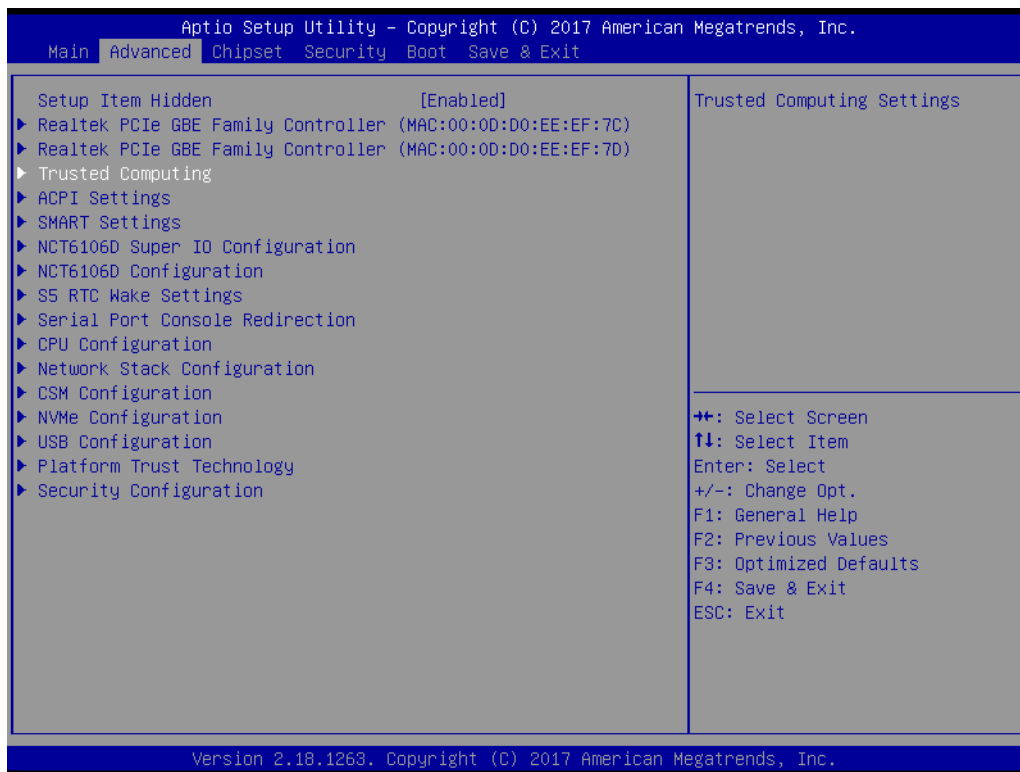


### 3.2.2.1 Realtek PCIe GBE Family Controller



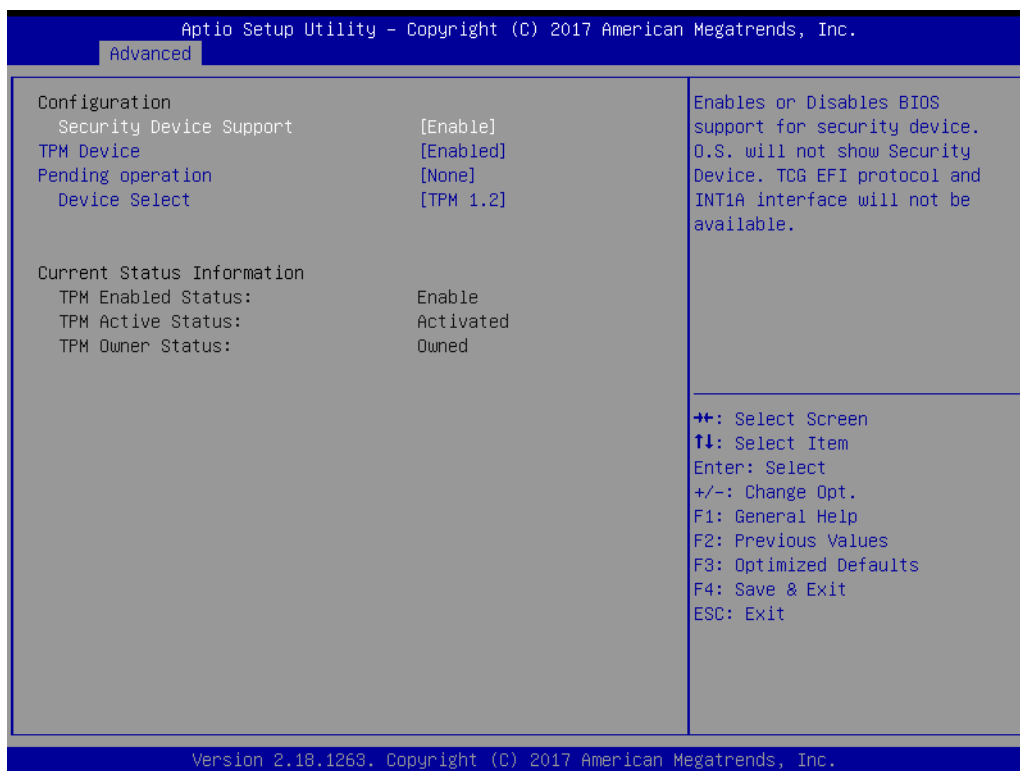


### 3.2.2.2 Trusted Computing

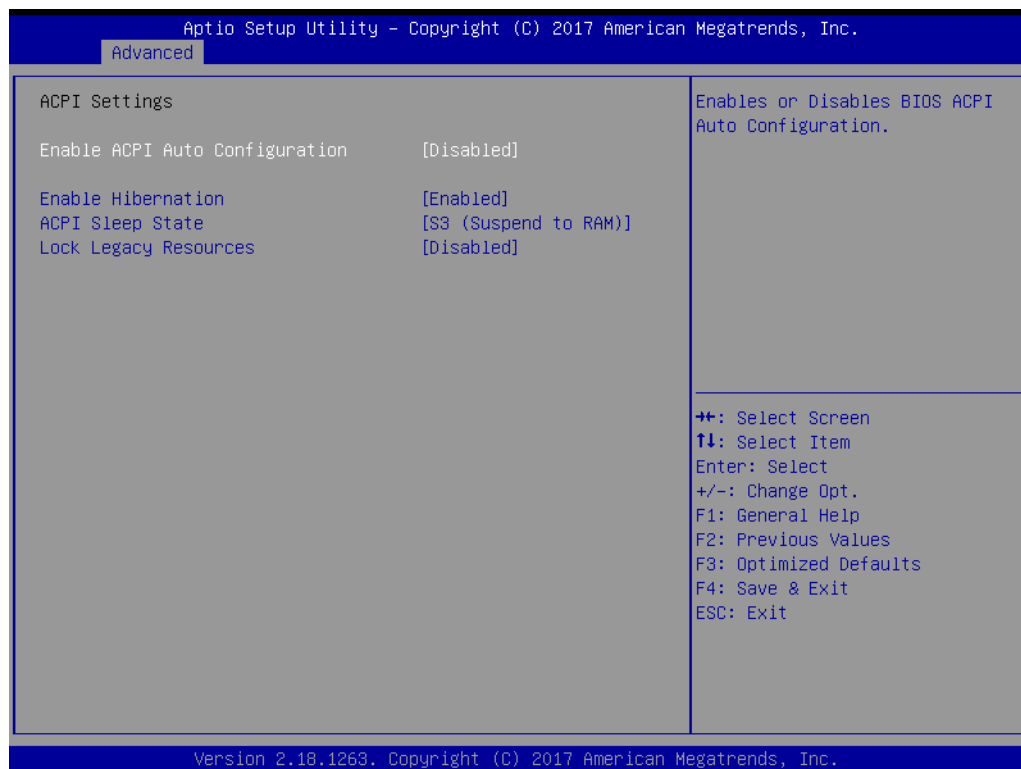
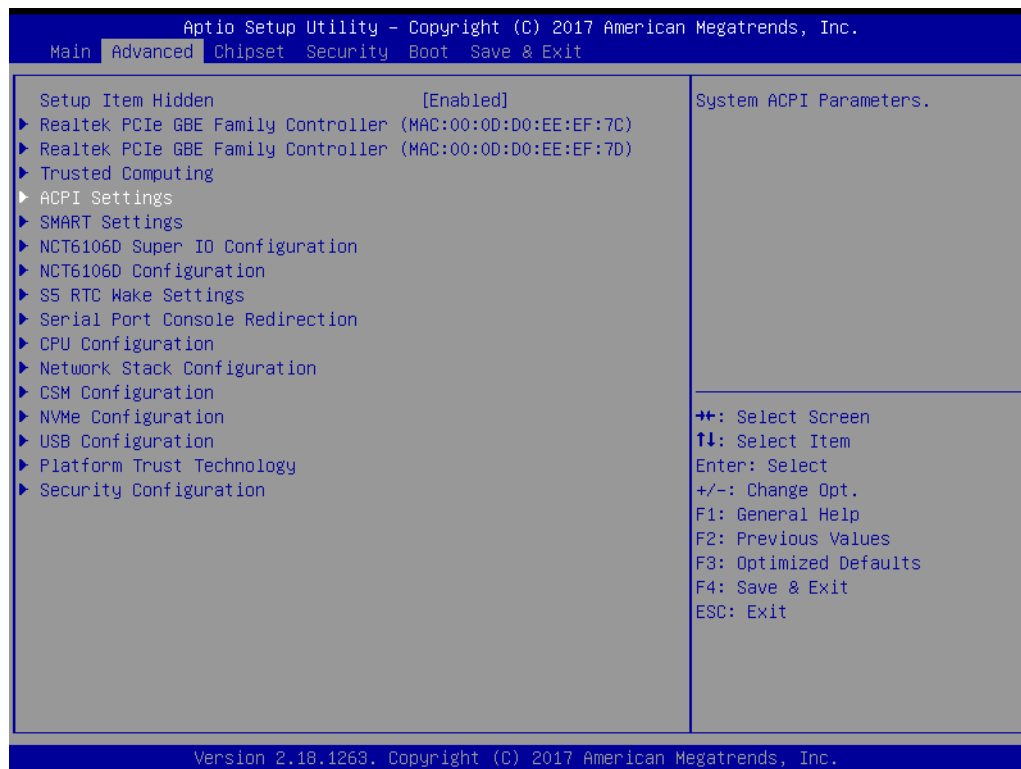


#### ■ Security Device Support

Enable or disable BIOS support for security device.



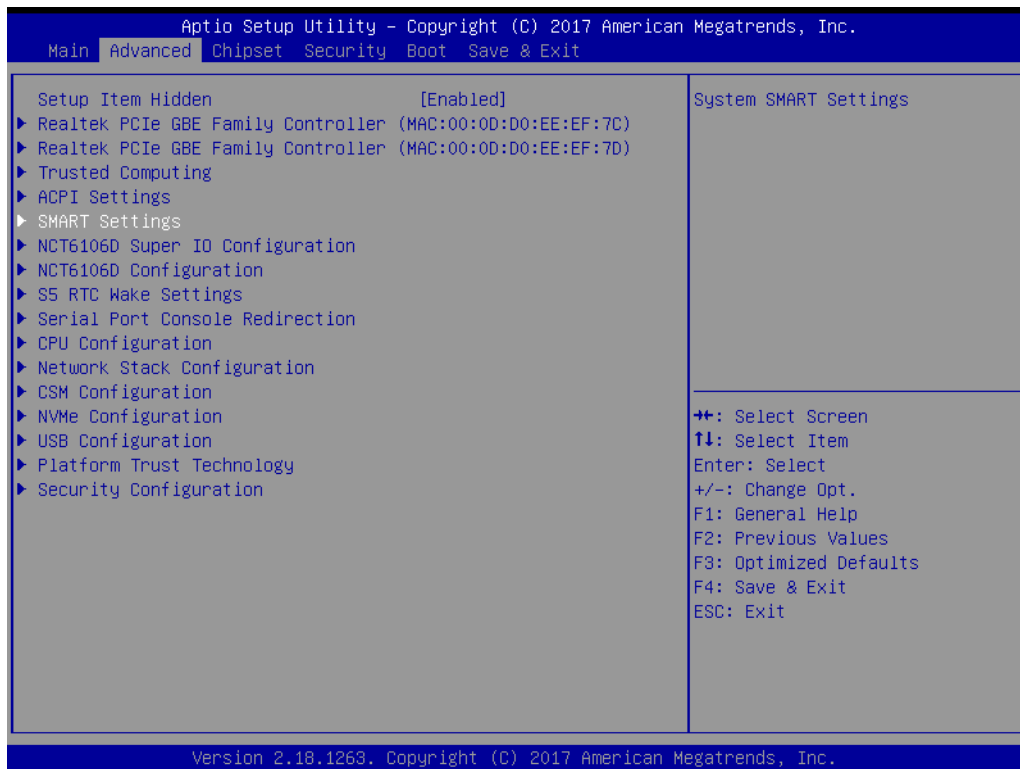
### 3.2.2.3 ACPI Settings



- **Enable ACPI Auto Configuration**  
Enable or Disable ACPI Auto Configuration.
- **Enable Hibernation**  
This item allows users to enable or disable hibernation.

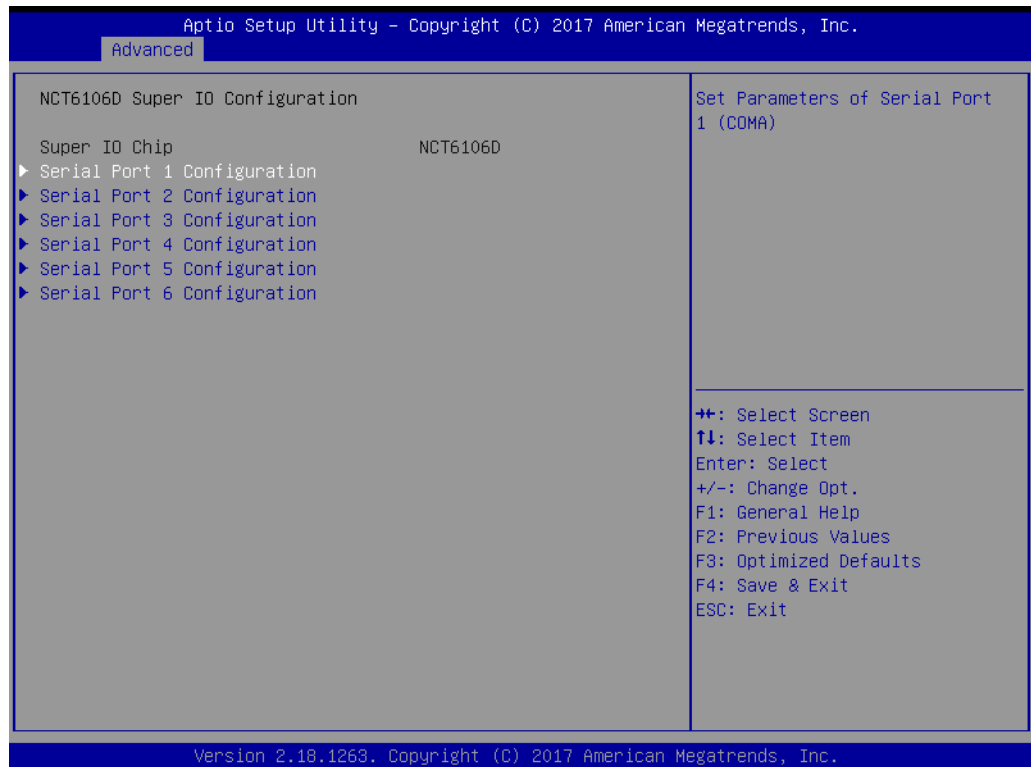
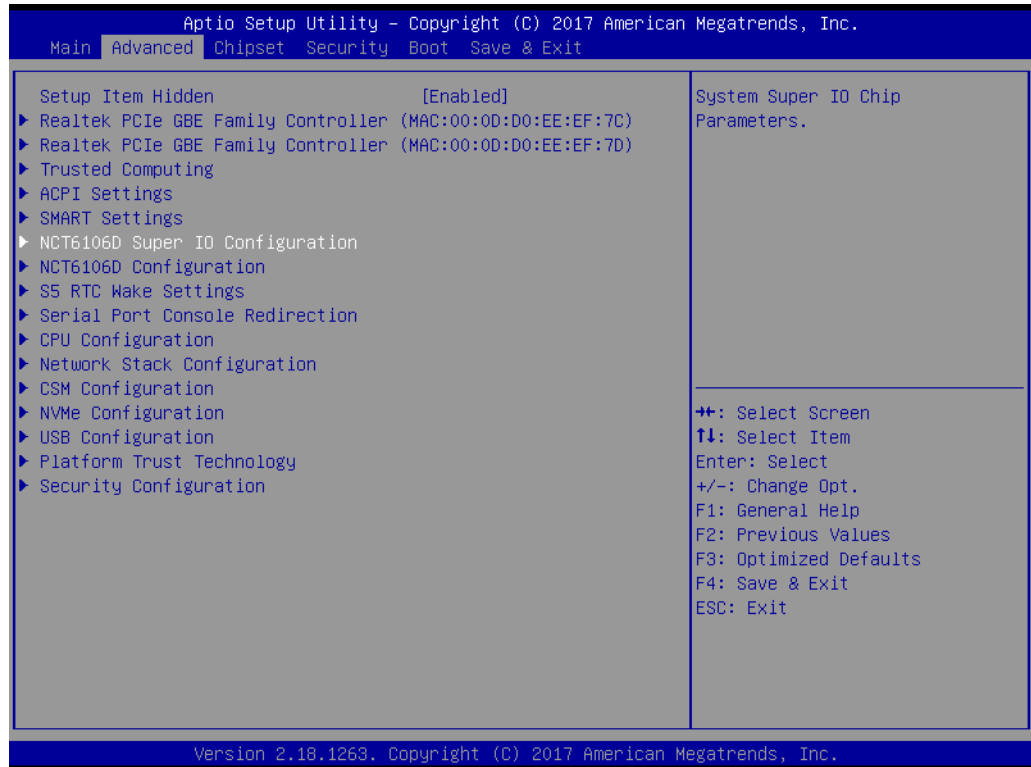
- **ACPI Sleep State**  
This item allows users to set the ACPI sleep state.
- **Lock Legacy Resources**  
This item allows users to lock legacy device resources.

### 3.2.2.4 SMART Settings

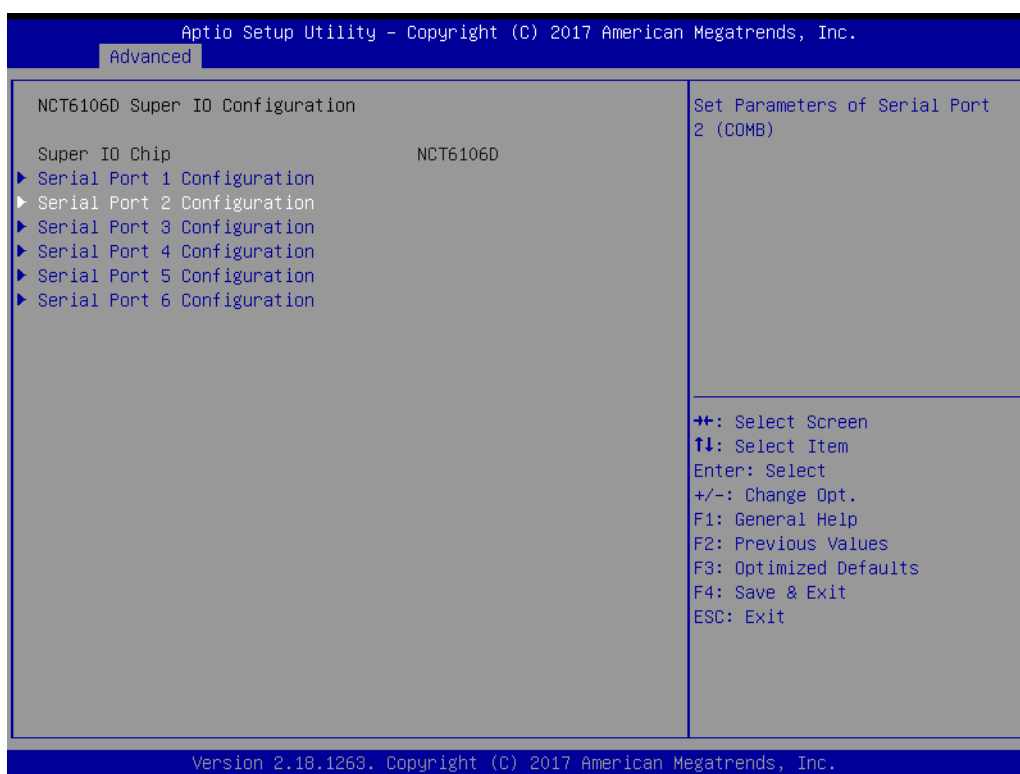
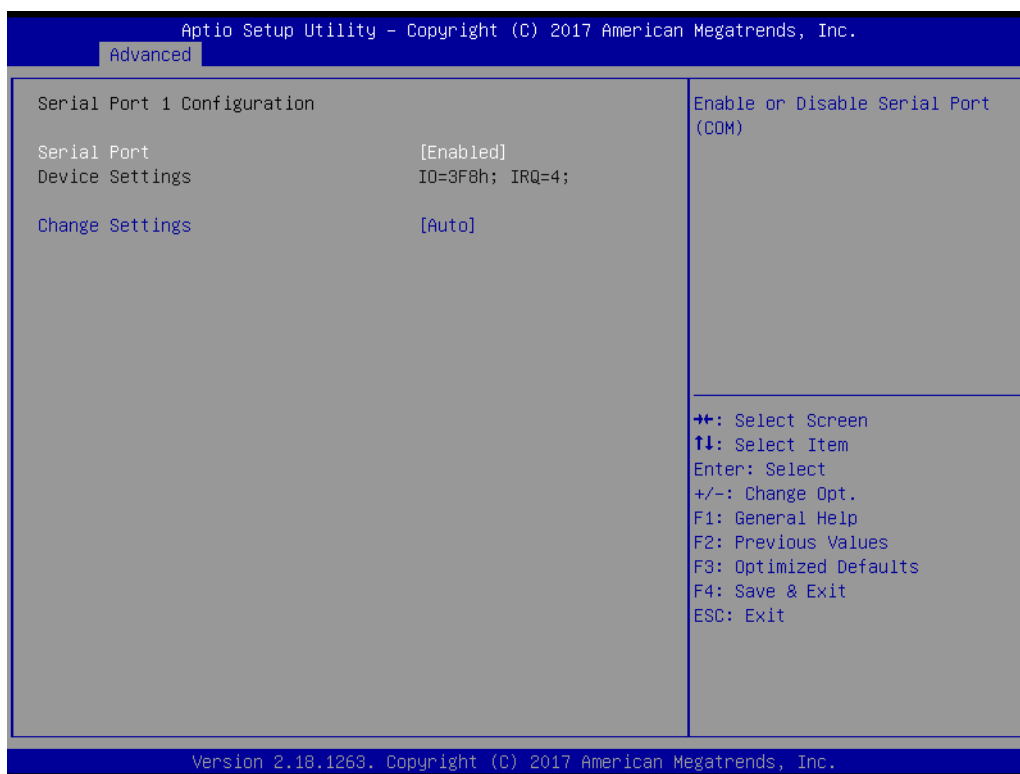


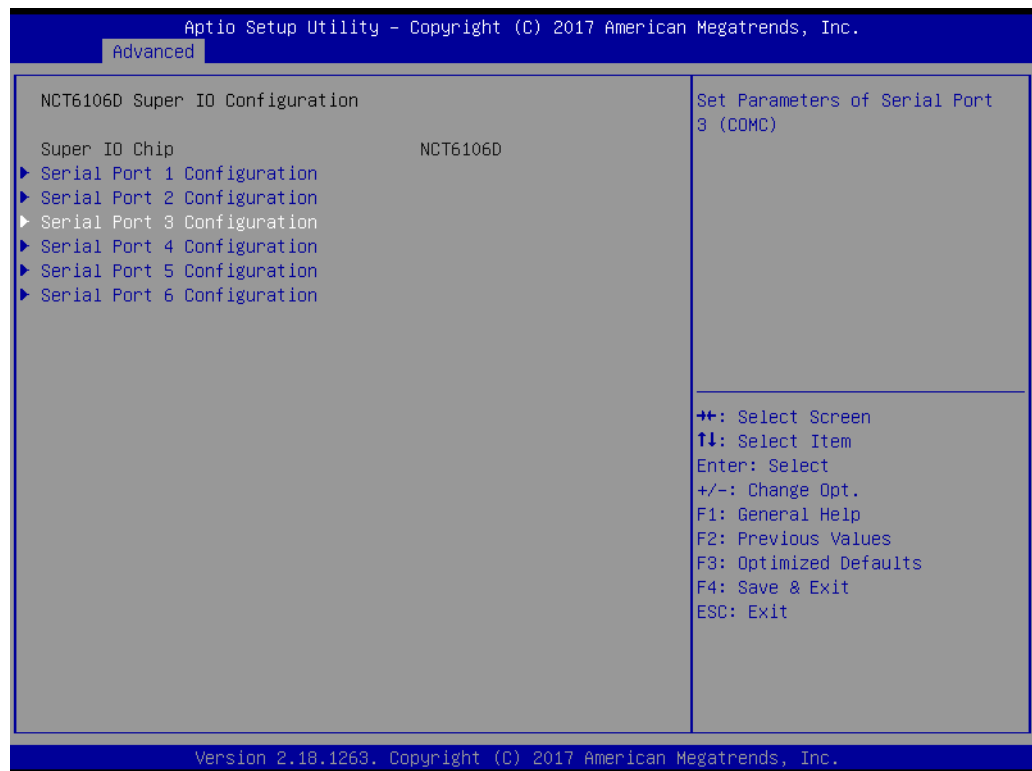
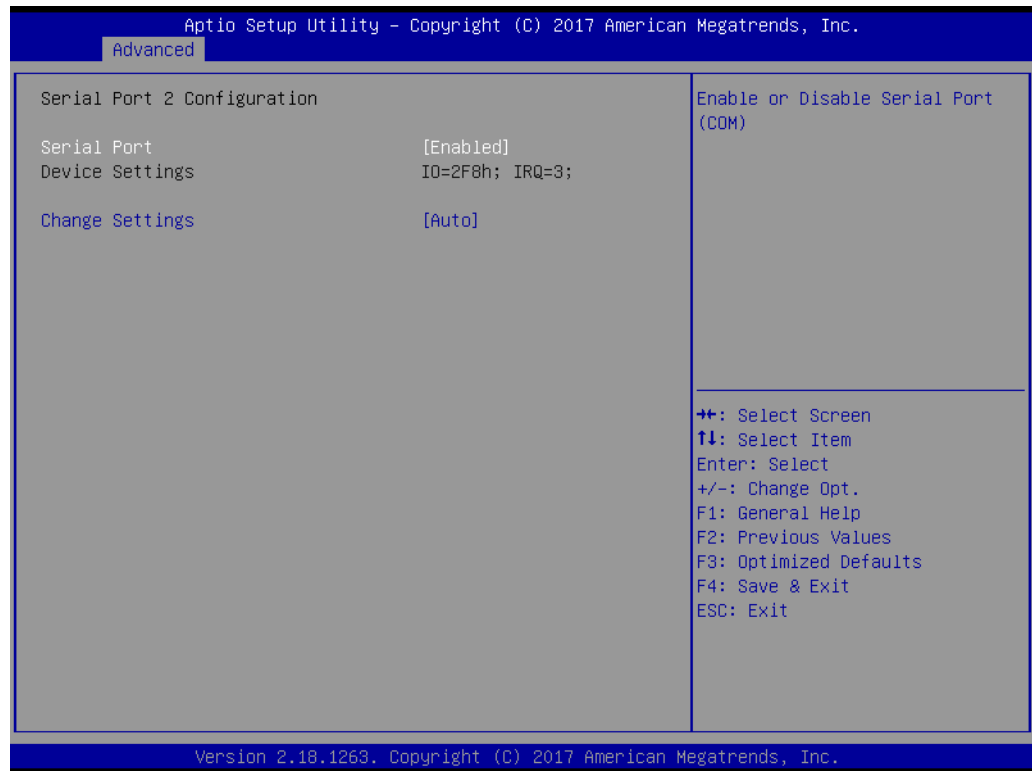
- **SMART Self Test**  
Enable or Disable SMART Self Test

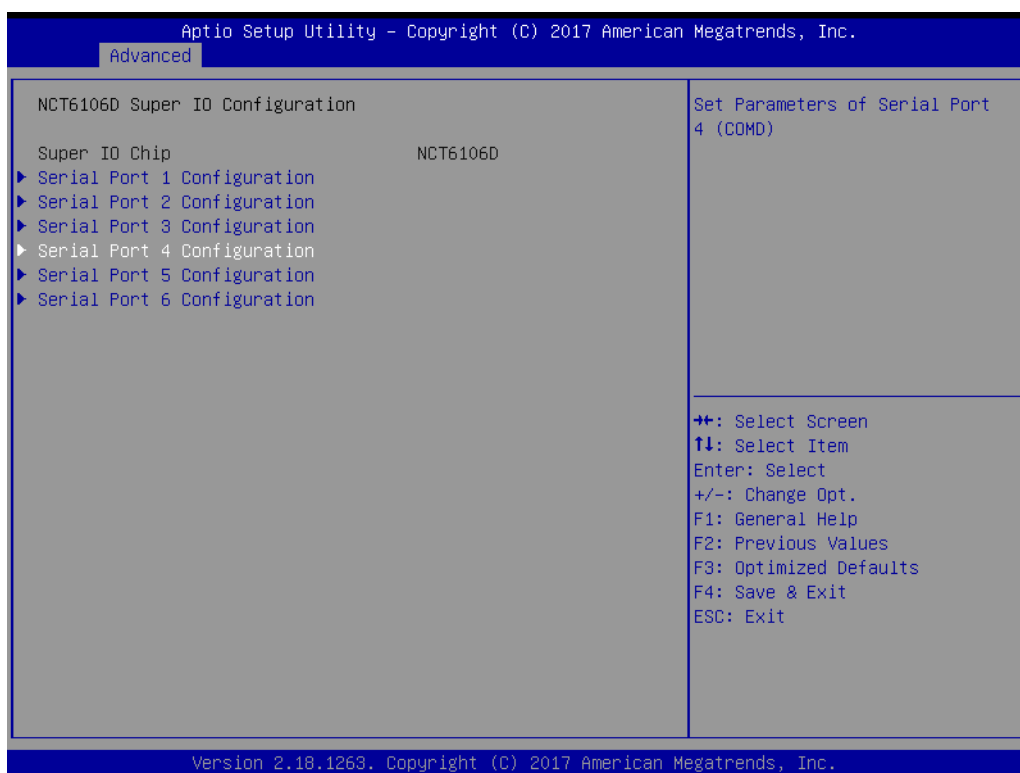
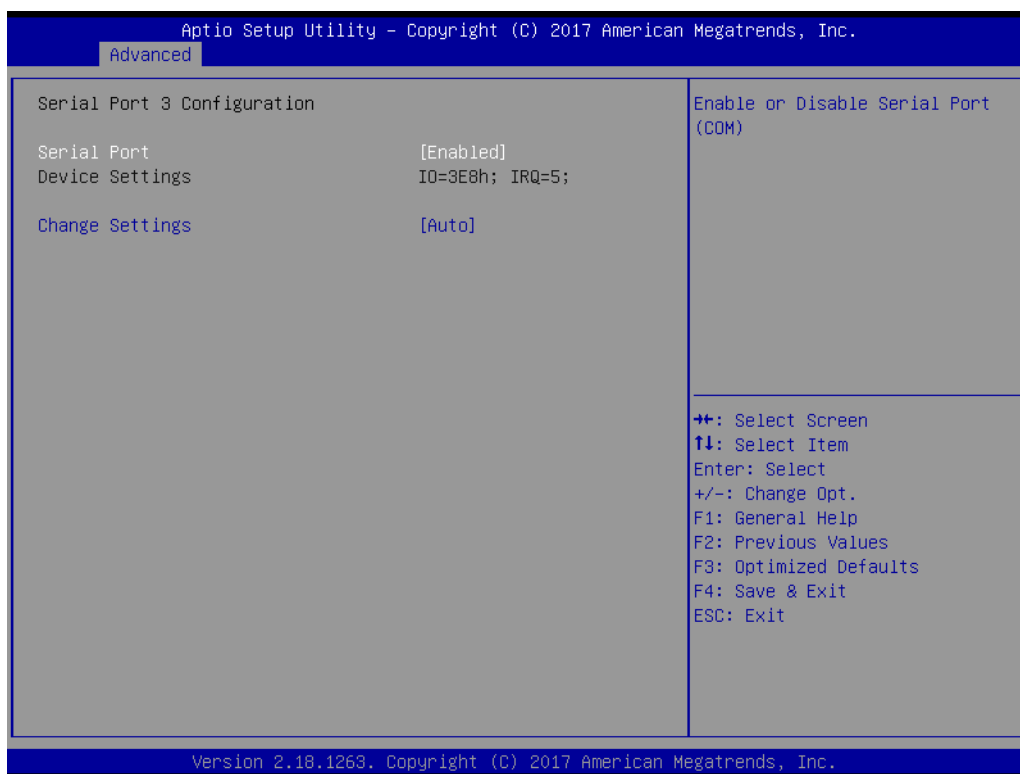
### 3.2.2.5 Super IO Configuration

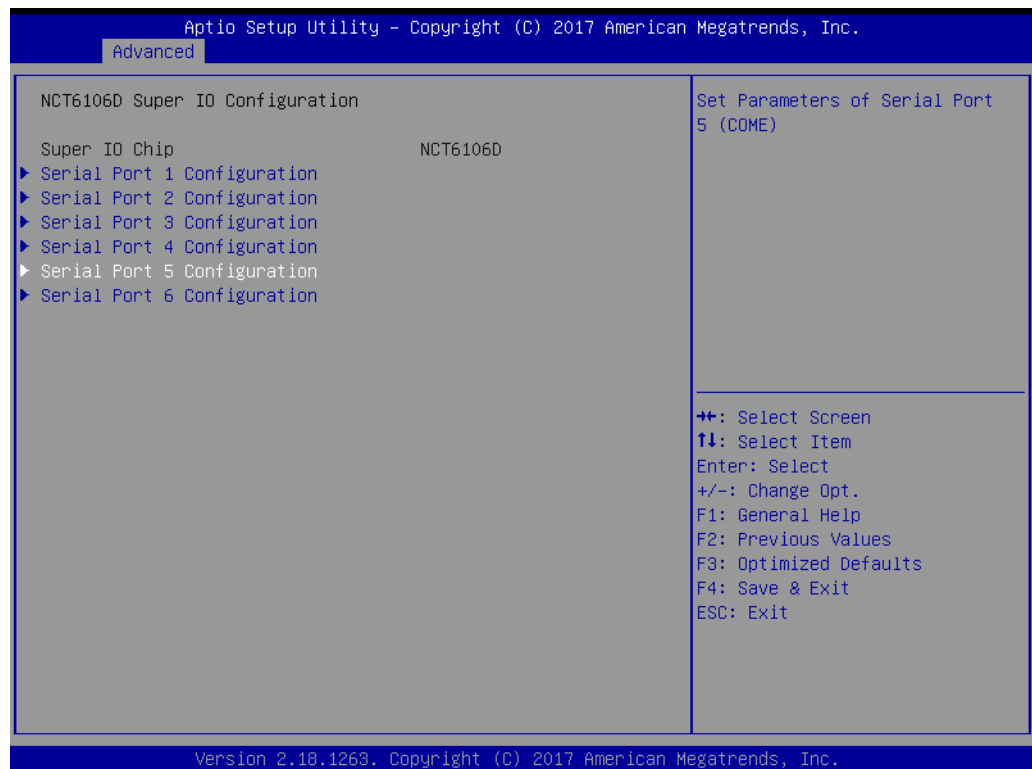
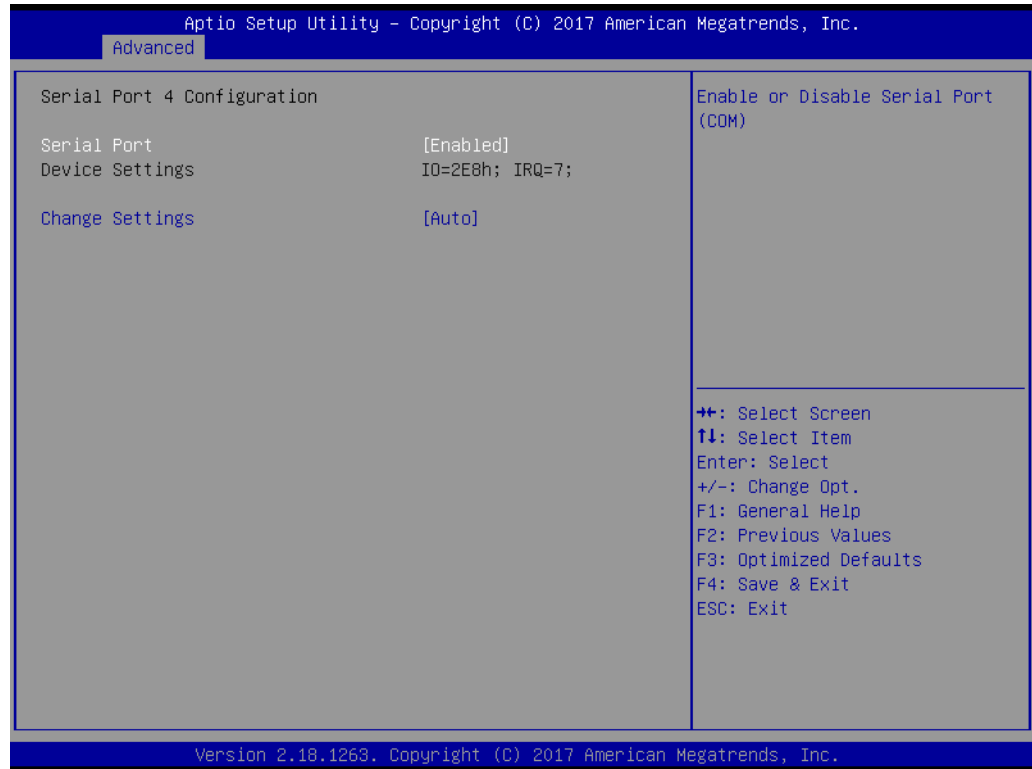


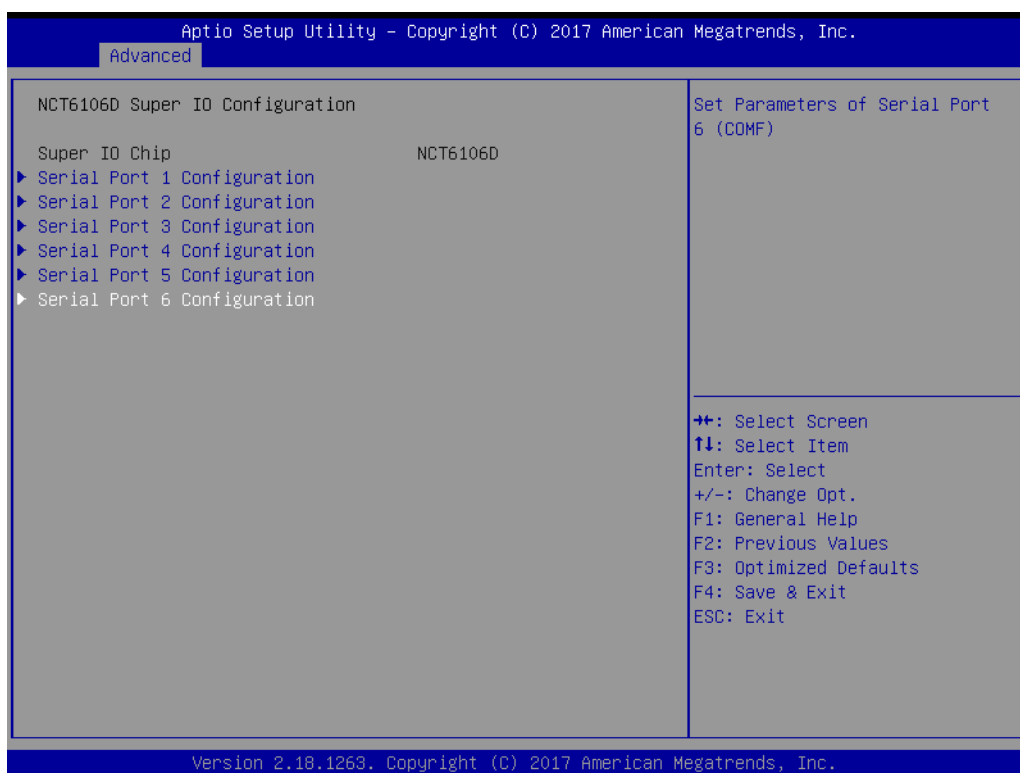
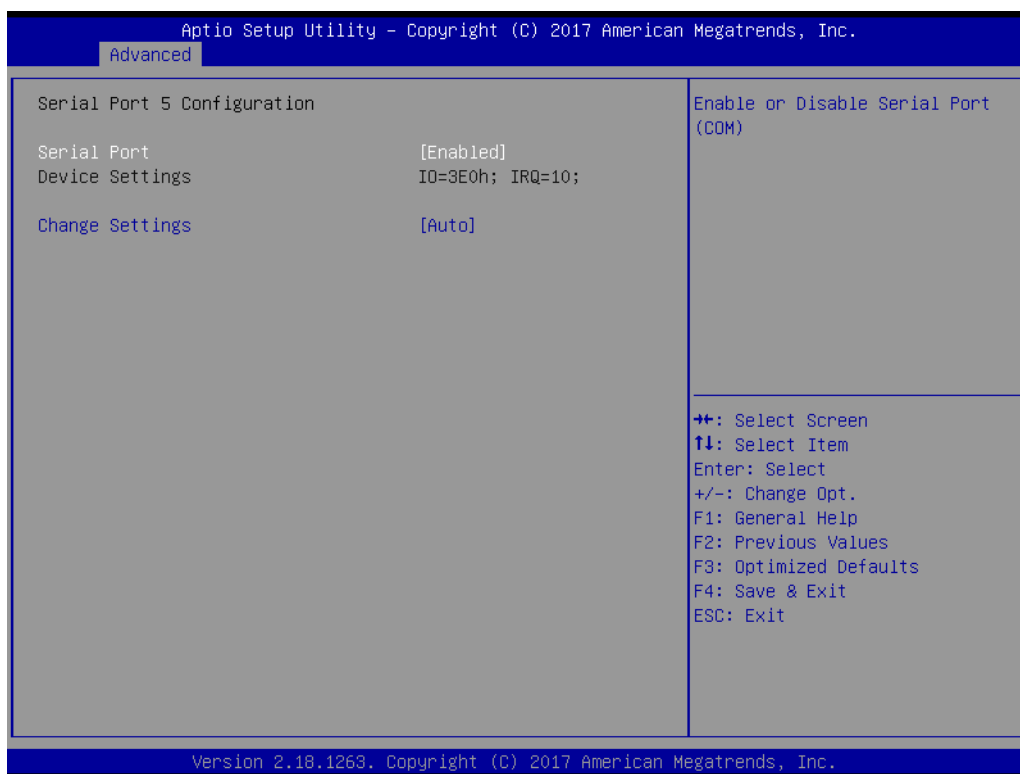










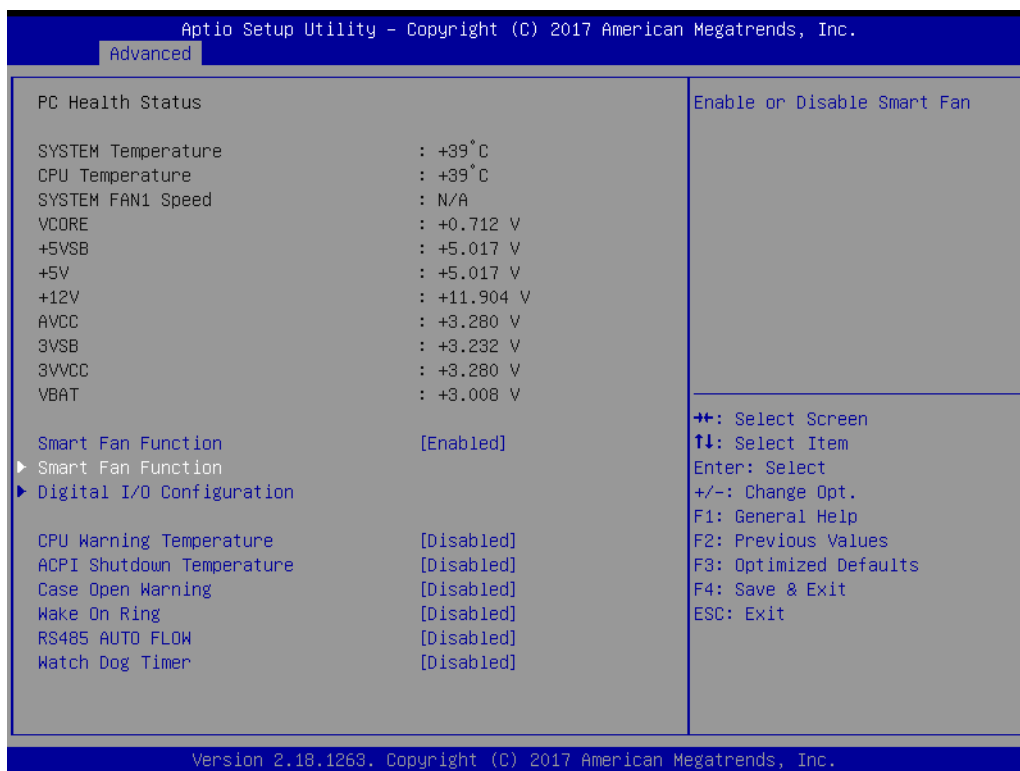
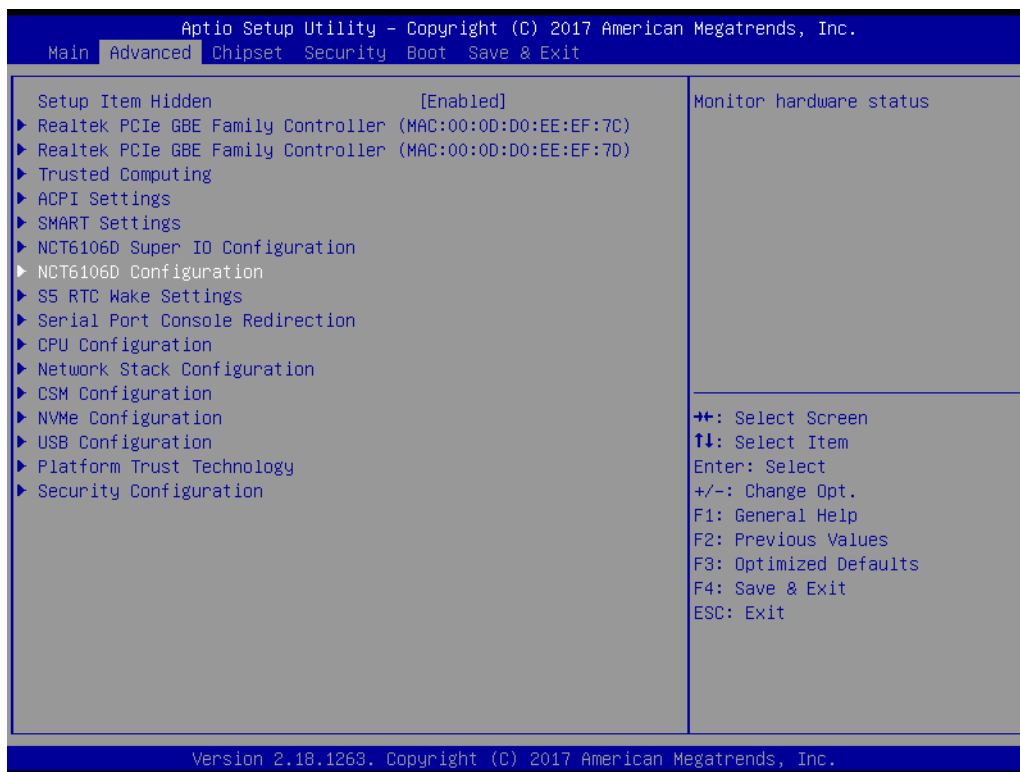




- **Serial Ports 1/2/3/4/5/6**  
This item allows users to enable or disable serial Ports 1/2/3/4/5/6.
- **Change Settings**  
This item allows users to change the serial port 1/2/3/4/5/6 setting.

### 3.2.2.6 NCT6106D Configuration

This page shows the AIMB-217 PC health status.



- **Smart Fan Function**  
This item allows users to enable or disable the System Smart Fan function.
- **CPU Warning Temperature**

This item allows users to set the CPU warning temperature threshold. When the system CPU reaches the warning temperature, the buzzer will beep.

- **ACPI Shutdown Temperature**

This item allows users to set the CPU temperature threshold at which the system automatically shuts down to prevent the CPU from overheating.

- **Case Open Warning**

This item allows users to enable or disable the Case Open Warning function.

- **Wake On Ring**

This item allows users to enable or disable Wake On Ring functionality.

- **RS-485 AUTO FLOW**

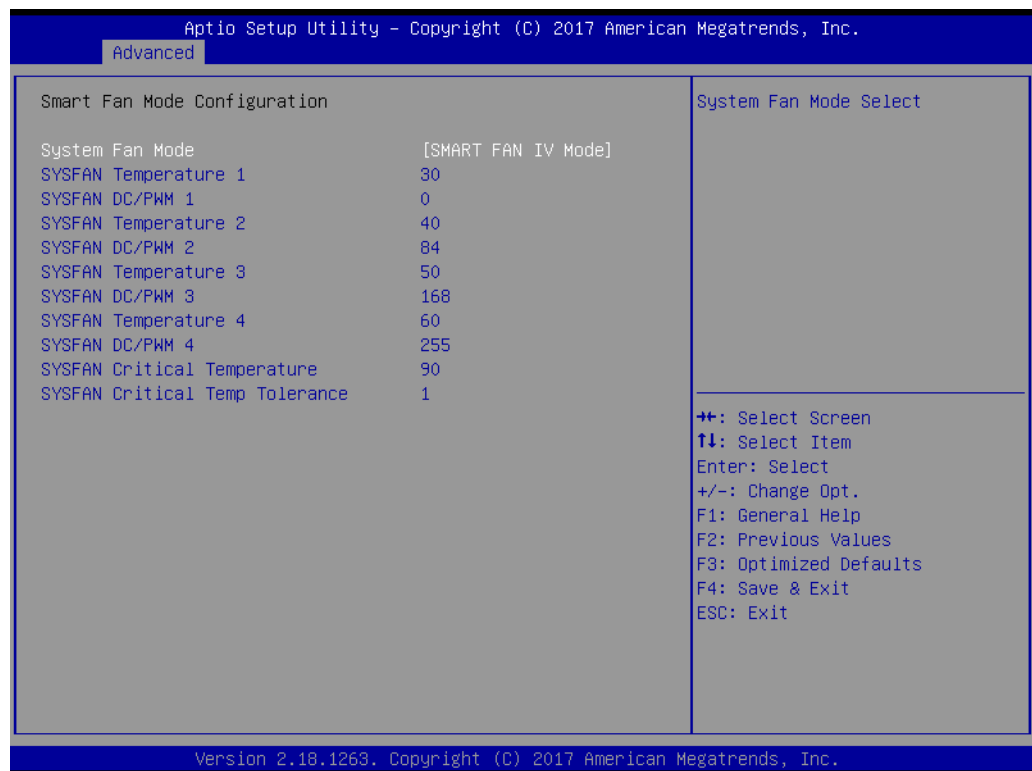
This item allows users to enable or disable the RS-485 AUTO FLOW function.

- **Watchdog Timer**

This item allows users to enable or disable the Watchdog timer.

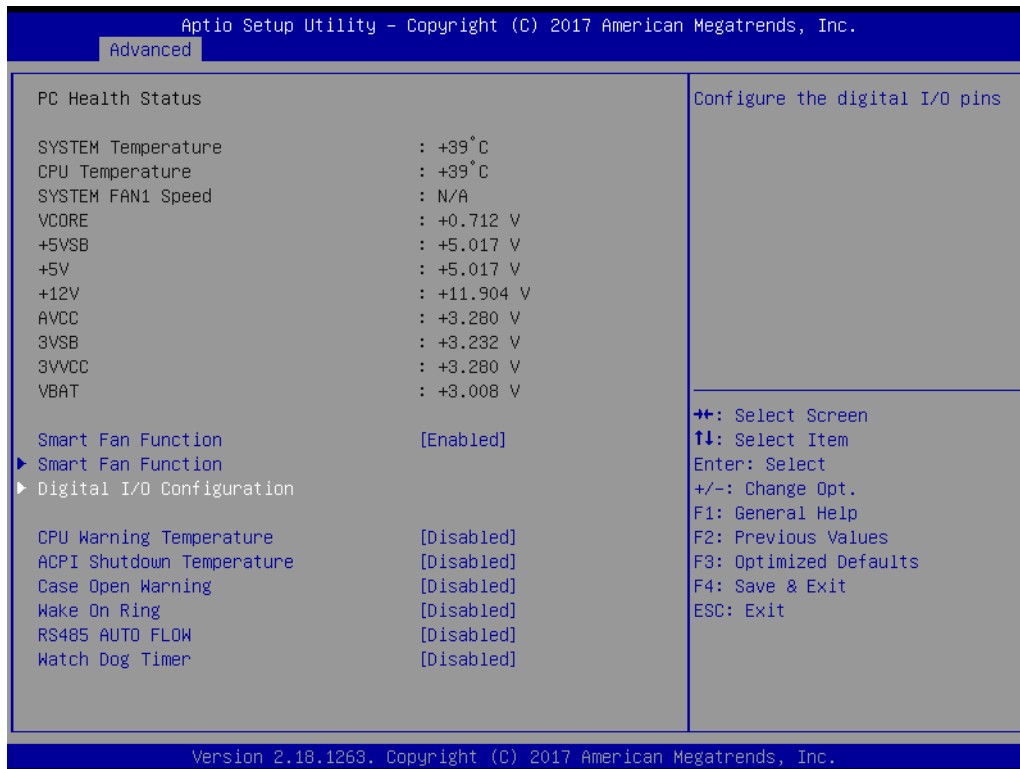
### 3.2.2.7 Smart Fan Mode Configuration

This page shows the details of Smart Fan Mode items.





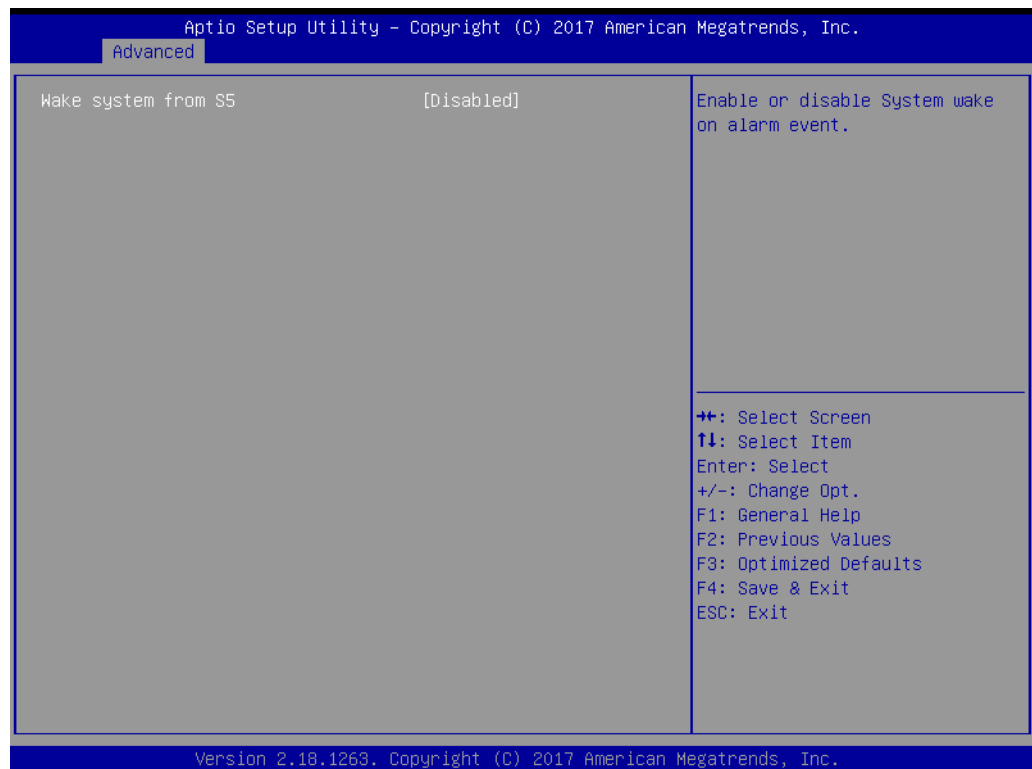
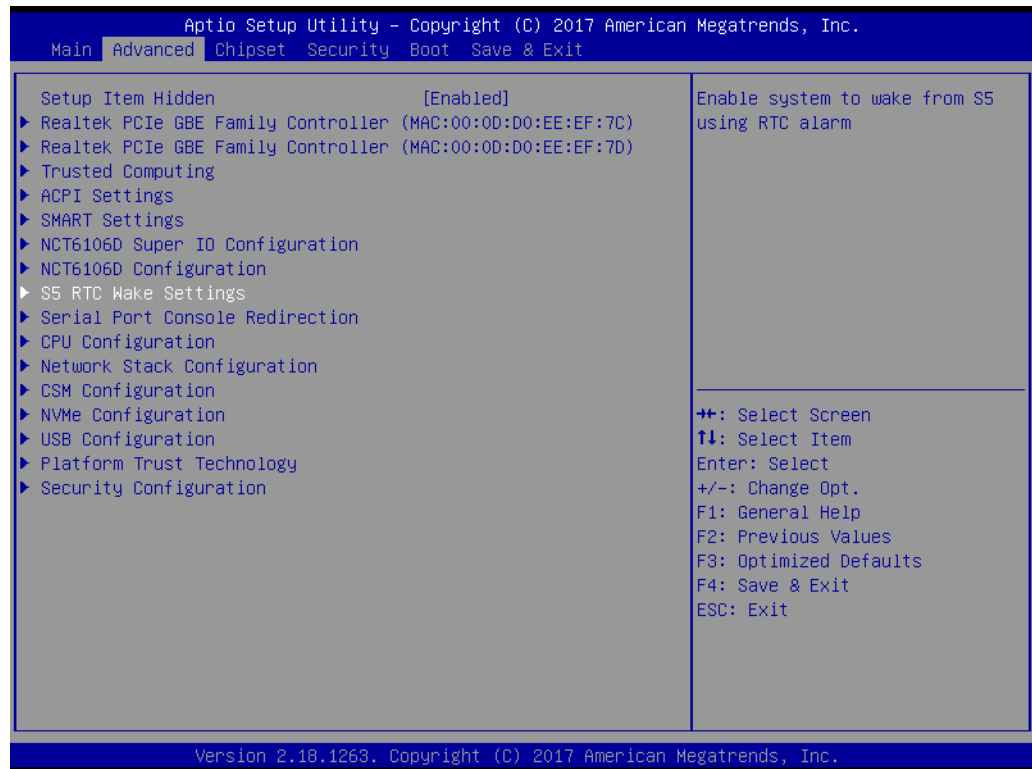
### 3.2.2.8 Digital I/O Configuration



- **Digital I/O Configuration**

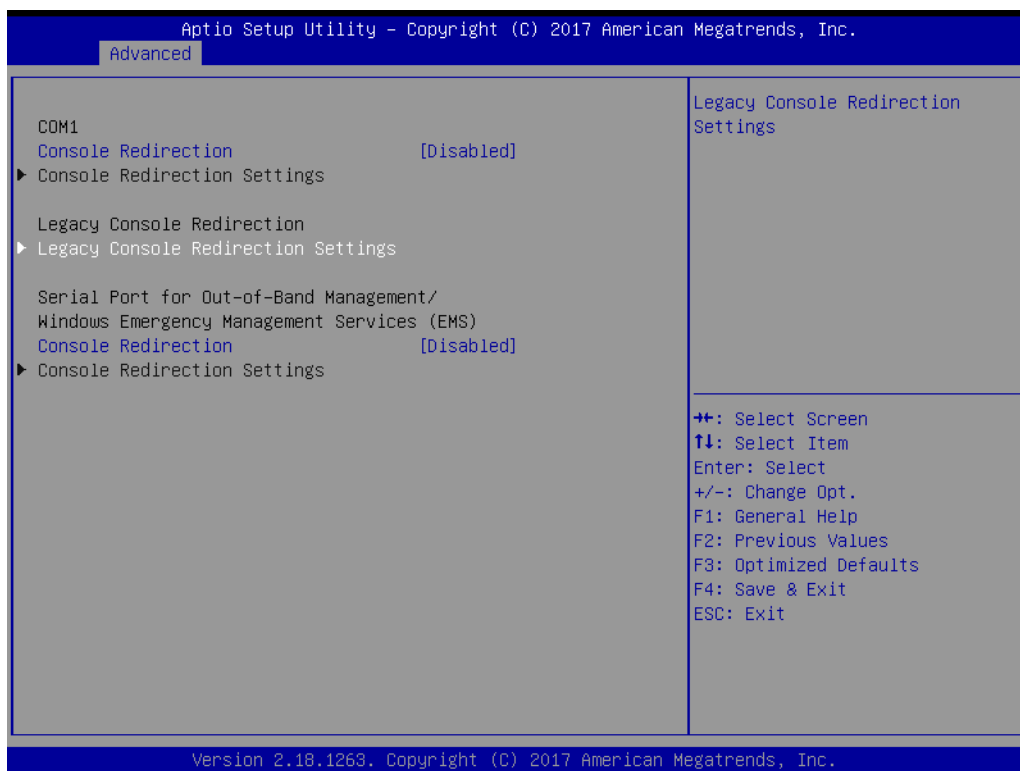
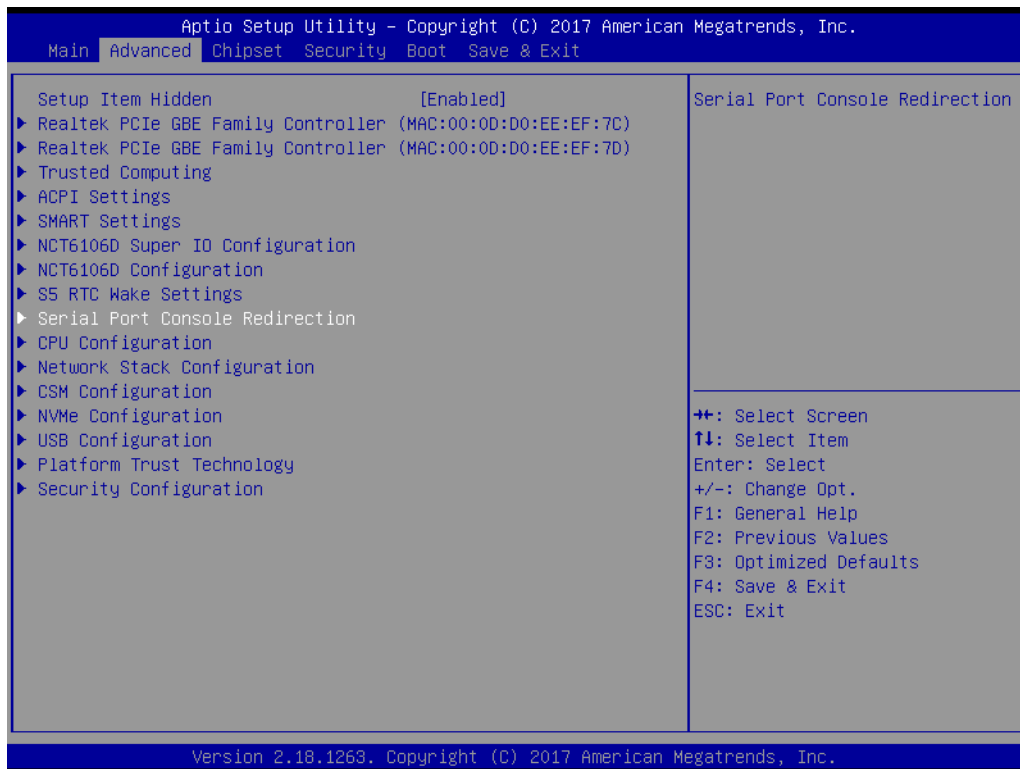
This item will allow users to set up Digital I/O 1~8 to "input" or "output".

### 3.2.2.9 S5 RTC Wake Settings



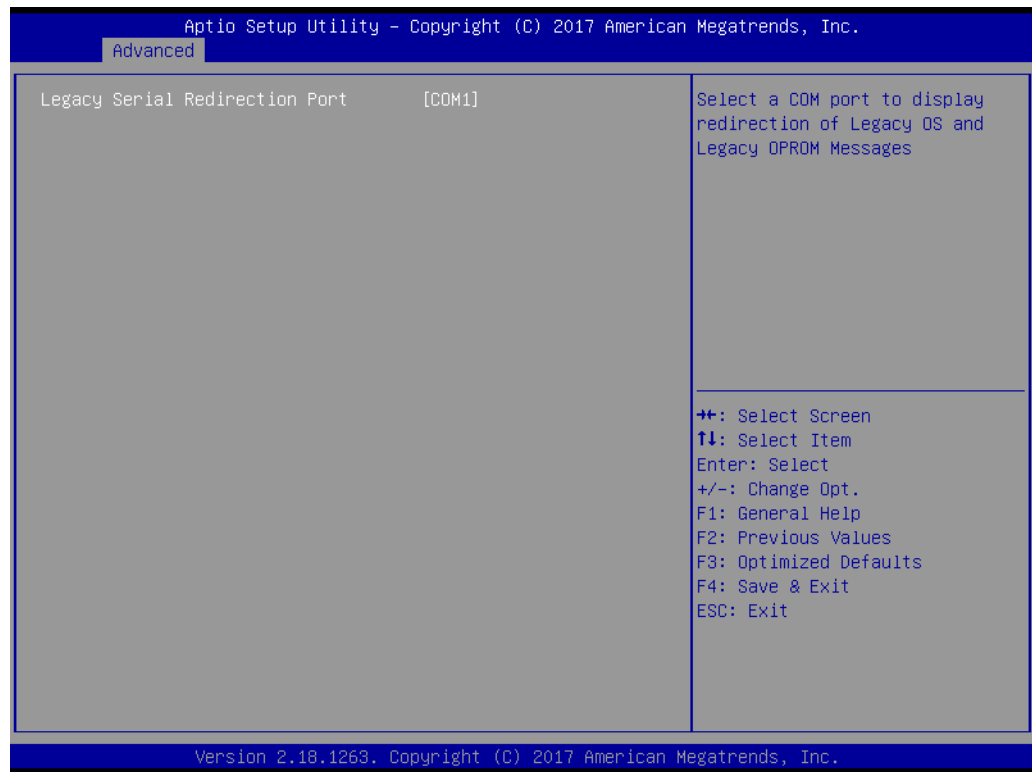
- **Wake System From S5**  
Enable or disable system wake on alarm event.

### 3.2.2.10 Serial Port Console Redirection



#### ■ Console Redirection

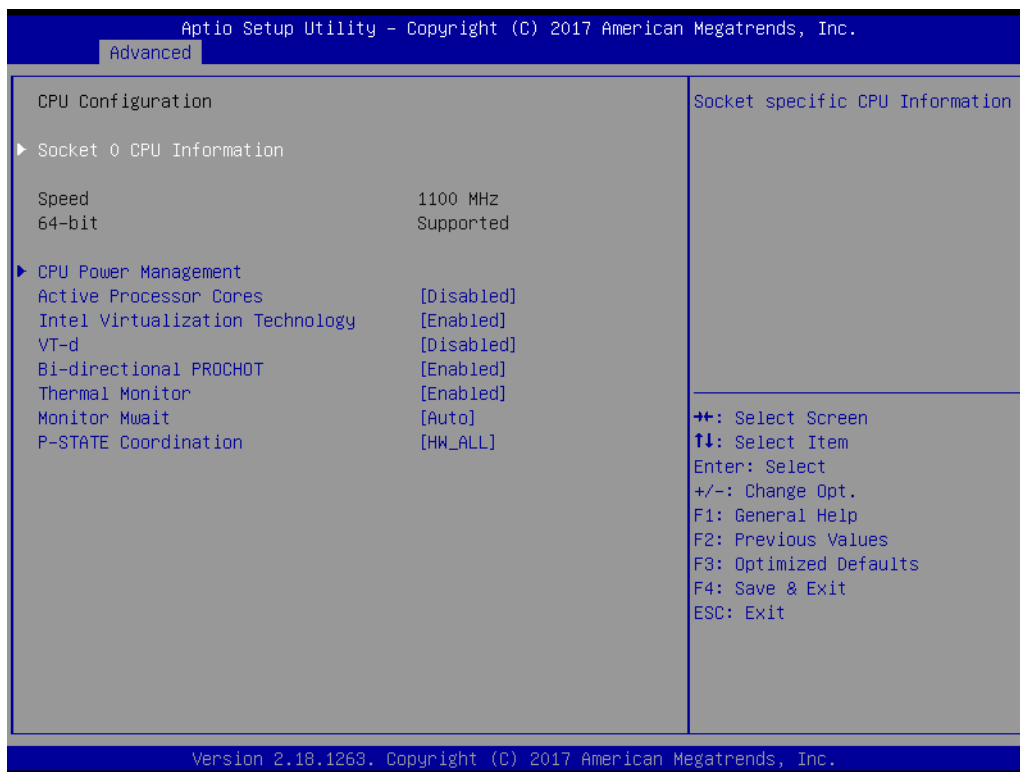
This item allows users to enable or disable console redirection.



- **Legacy Serial Redirection Port (COM1)**  
Select a COM port to display redirection of legacy OS and legacy OPROM messages.

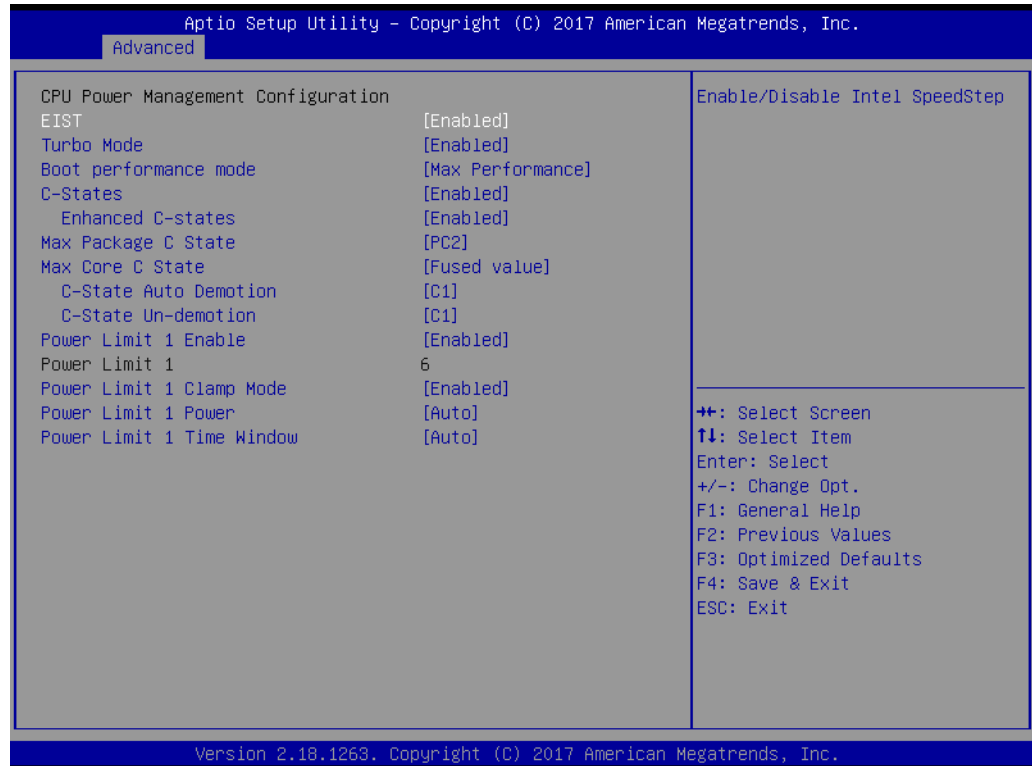
### 3.2.2.11 CPU Configuration

This page shows CPU Information.



- **Active Power Cores**  
Number of cores to enable in each processor package
- **Intel Virtualization Technology**  
When enabled, a VMM can utilize the additional hardware capabilities provided by Vanderpool Technology.
- **VT-d**  
Enable or disable VT-d.
- **Bi-directional PROCHOT**  
When a processor thermal sensor trips (either core), the PROCHOT# will be driven. If bi-direction is enabled, external agents can drive PROCHOT# to throttle the processor.
- **Thermal Monitor**  
Enable or disable Thermal Monitor.
- **Monitor Mwait**  
Enable/disable Monitor Mwait.
- **P-STATE Coordination**  
Change P-STATE Coordination type.

## CPU Power Management Configuration

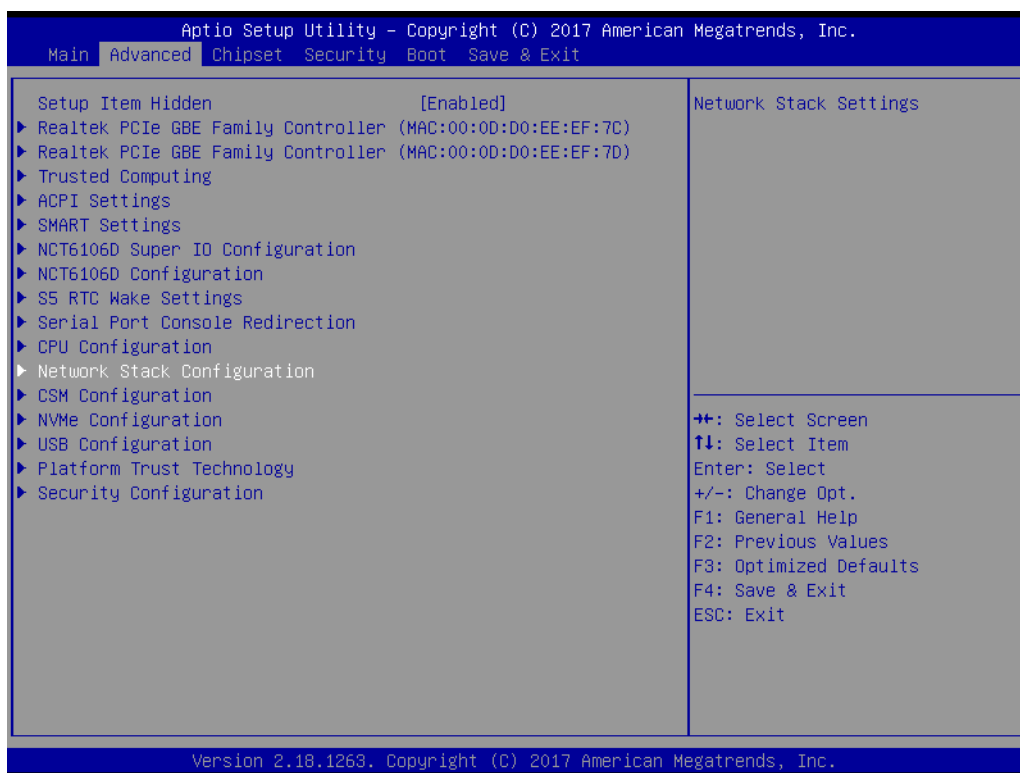


- **EIST**  
Enabled or disabled Intel Speed Step function.
- **Turbo Mode**  
Enabled or disabled Turbo Mode
- **Boot performance mode**  
Select the performance state that the BIOS will set before OS handoff.
- **C-States**  
Enabled or disabled C-States
- **Enhanced C-States**  
Enabled or disabled C1E. When enabled, CPU will switch to minimum speed when all cores enter C-State.
- **Max Package C State**  
Controls the max package C state that the processor will support.
- **Max Core C State**  
This option controls the Max Core C State that cores will support.
- **C-State Auto Demotion**  
Configure C-State Auto Demotion.
- **C-State Un-Demotion**  
Configure C-State Un-demotion.
- **Power Limit 1 Enable**  
Enable/Disable Power Limit 1.
- **Power Limit 1 Clamp Mode**  
Enable/Disable Power Limit 1 Clamp Mode.
- **Power Limit 1 Power**  
Power Limit 1 in Watts. Auto will program Power Limit 1 based on silicon default support value.

- **Power Limit 1 Time Window**

Power Limit 1 Time Window Value in seconds. Auto will program Power Limit 1 Time Window based on silicon default support value.

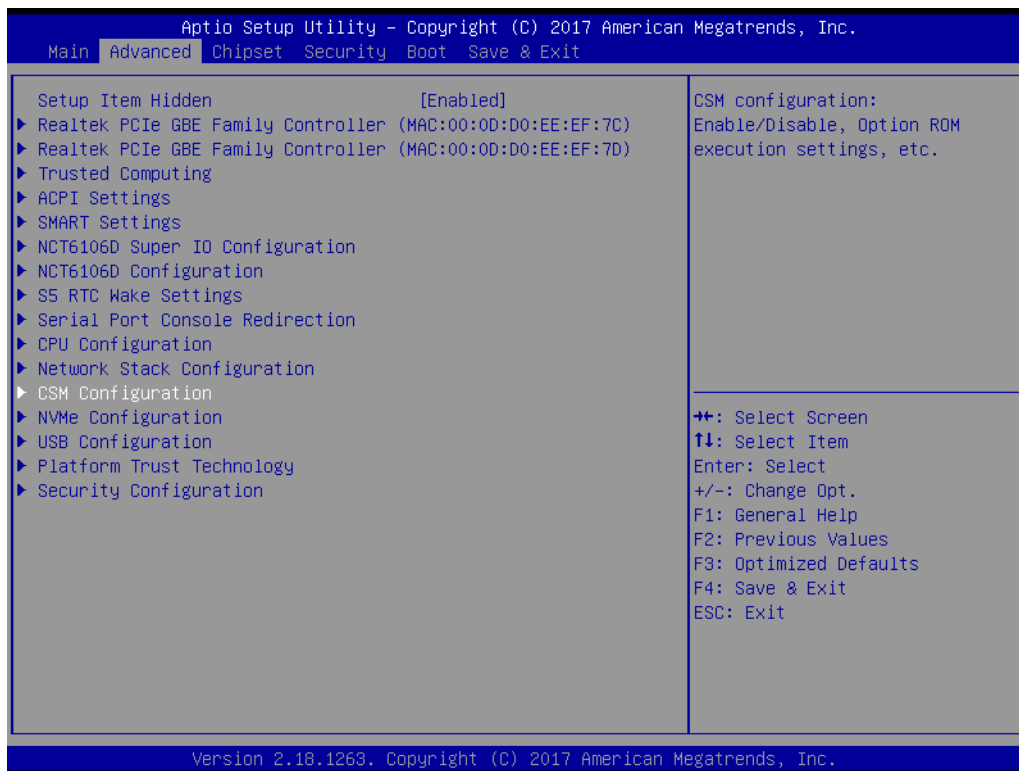
### 3.2.2.12 Network Stack Configuration



- **Network Stack**

Enable or disable UEFI Network Stack.

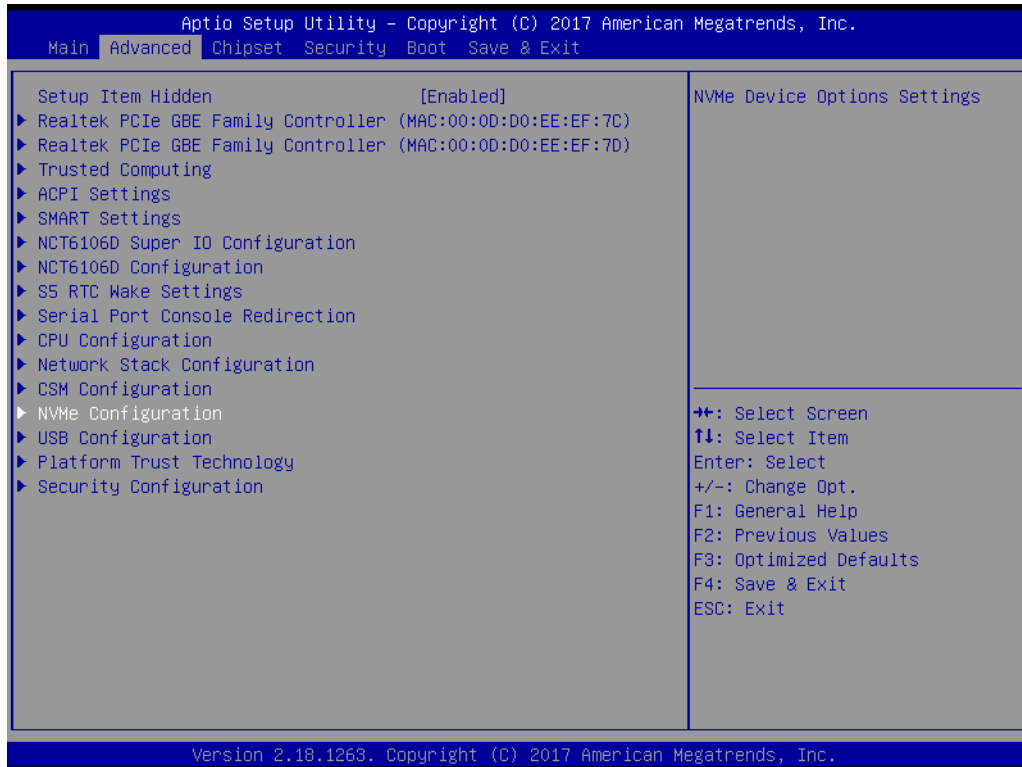
### 3.2.2.13 CSM Configuration



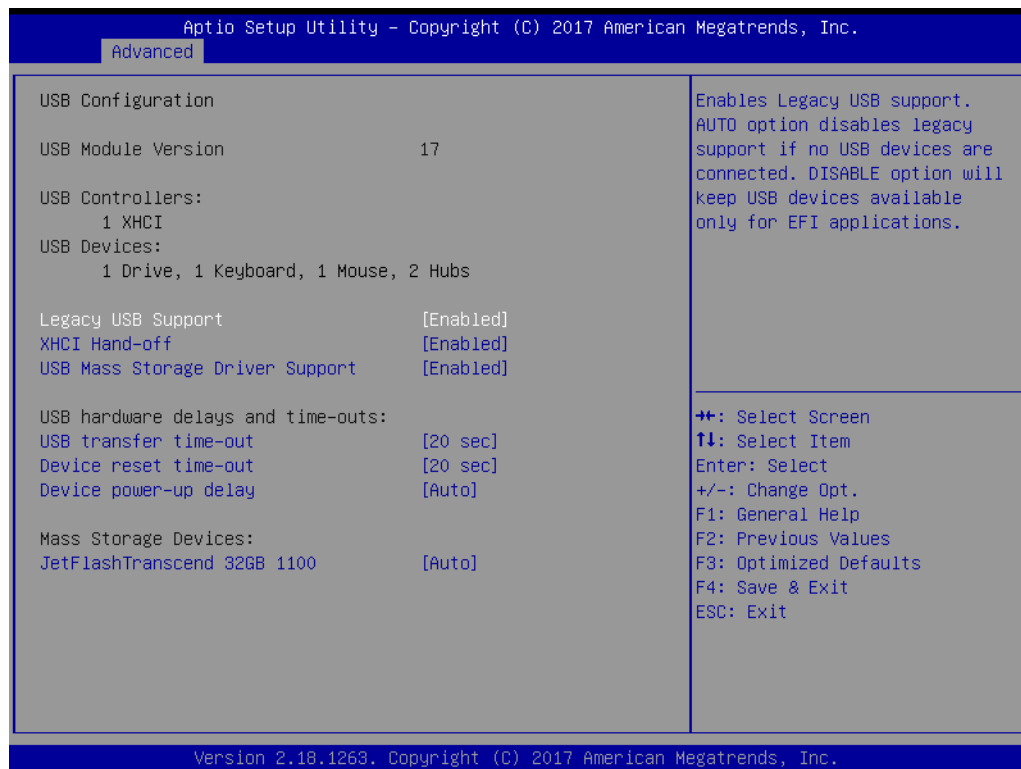
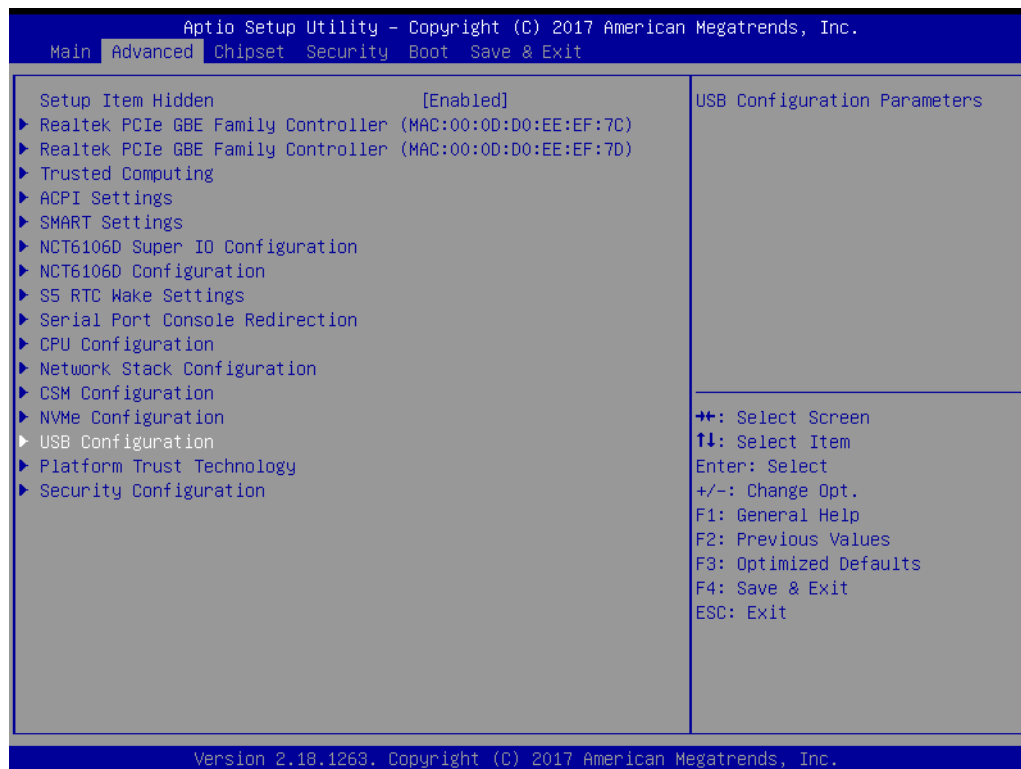
- **CSM Support**  
Enable or disable CSM Support.



### 3.2.2.14 NVMe Configuration



### 3.2.2.15 USB Configuration

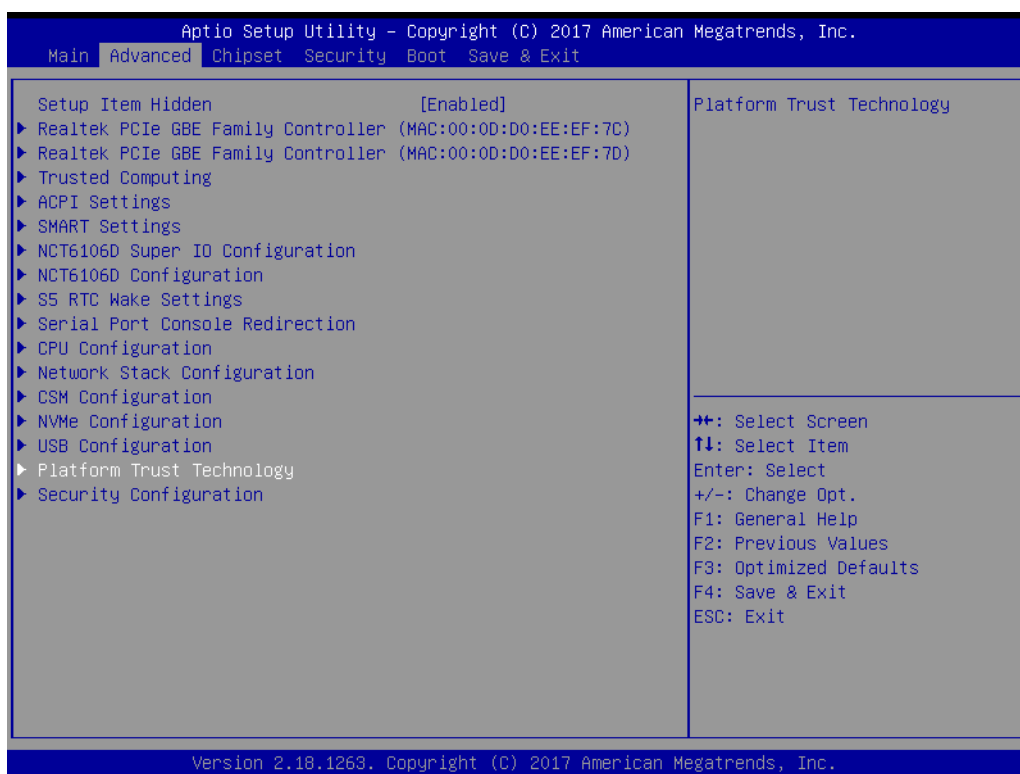


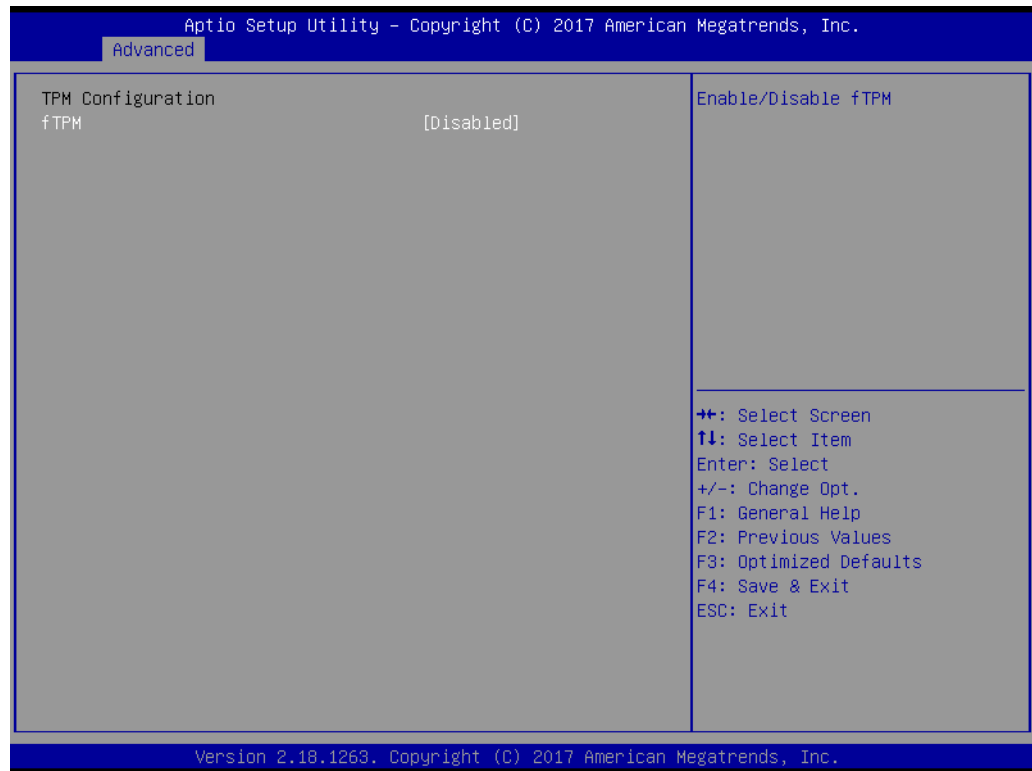
- **Legacy USB support**

Enables support for legacy USB. Auto option disables legacy support if no USB devices are connected. DISABLE option will keep USB devices available only for EFI applications.

- **XHCI Hands Off**  
This is a workaround for OS without XHCI hand-off support. The XHCI ownership change should claim by XHCI driver.
- **USB Mass Storage Driver Support**  
This item allows users to enable or disable USB Mass Storage Driver.
- **USB transfer time-out**  
Time-out value for control, bulk, and interrupt transfers.
- **Device reset time-out**  
USB mass storage device starts unit command time-out.
- **Device power-up delay**  
Maximum time the device will take before it properly report itself to the host controller. 'Auto' uses default value: for a Root port it is 100 ms, for a Hub port the delay is taken from Hub descriptor.
- **Mass storage device**  
Mass storage device emulation type. 'AUTO' enumerates devices according to their media format. Optical drives are emulated as 'CDROM', drives with no media will be emulated according to a drive type.

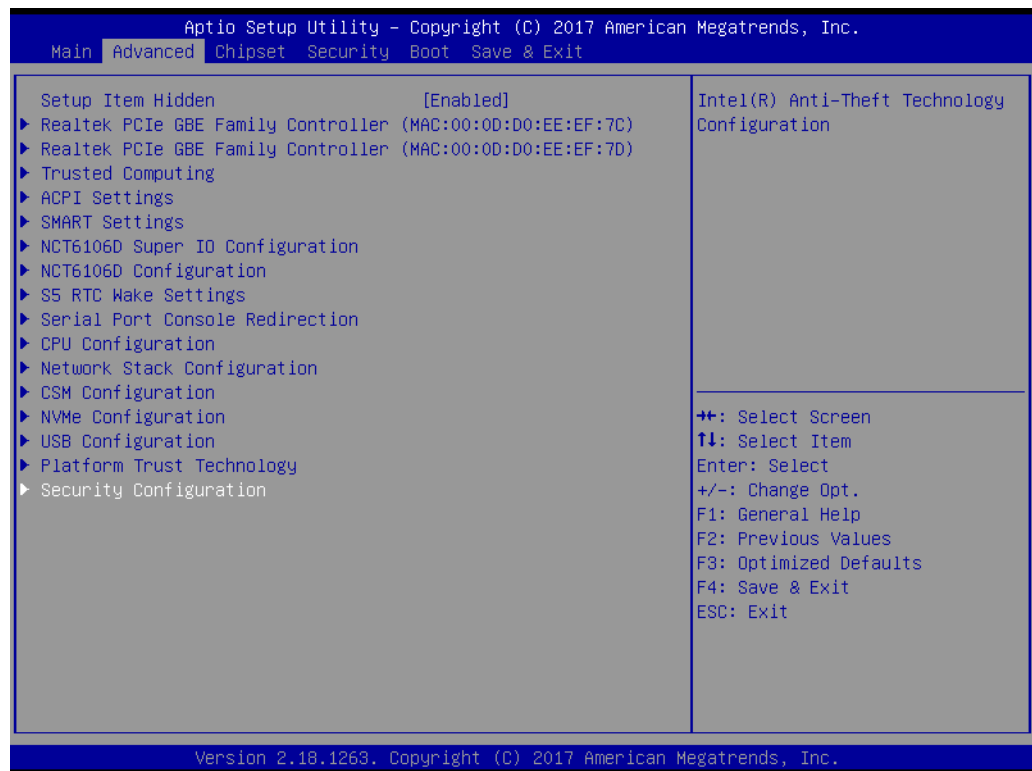
### 3.2.2.16 Platform Trust Technology

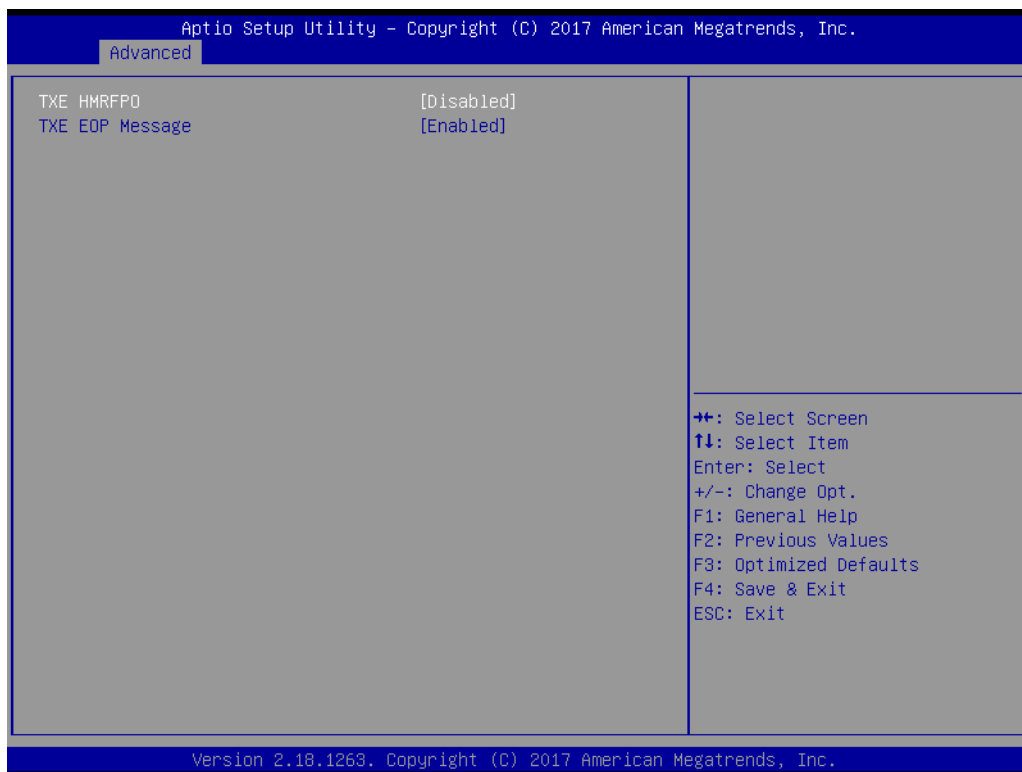




- **fTPM**  
Enabled or disabled fTPM

### 3.2.2.17 Security Configuration



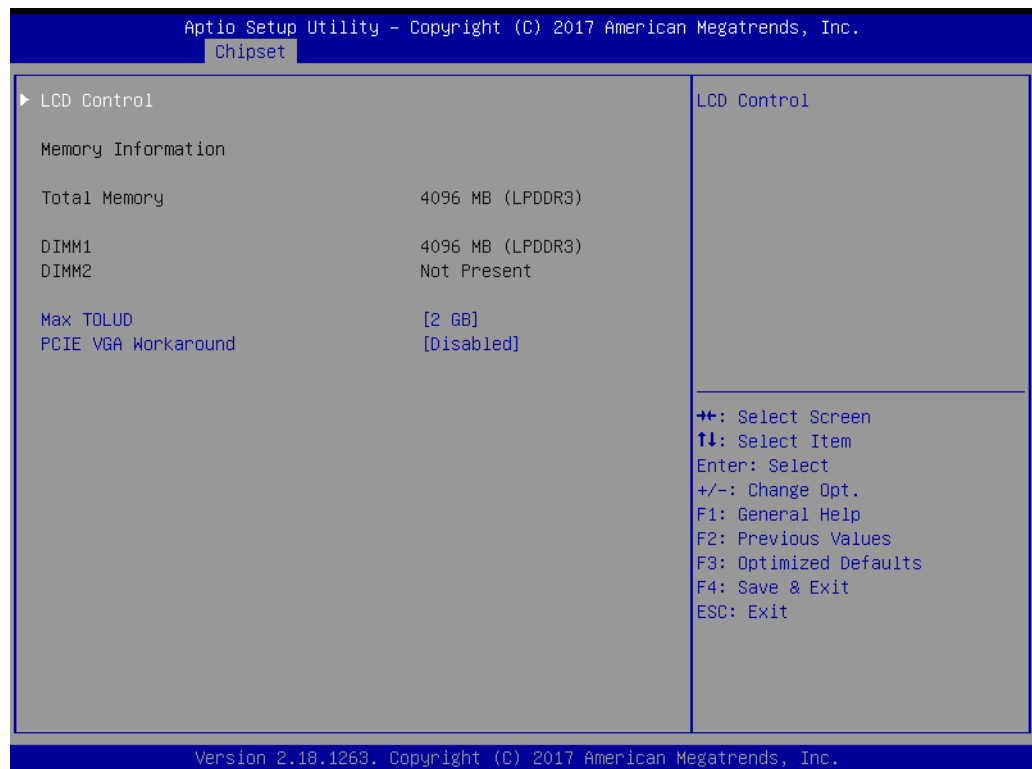


- **TXE HMRFP0**  
This item allows users to enable or disable TXE HMRFP0.
- **TXE EOP Message**  
Send EOP Message before Enter OS.

### 3.2.3 Chipset

This page provides information of the chipset on AIMB-217.

#### 3.2.3.1 North Bridge

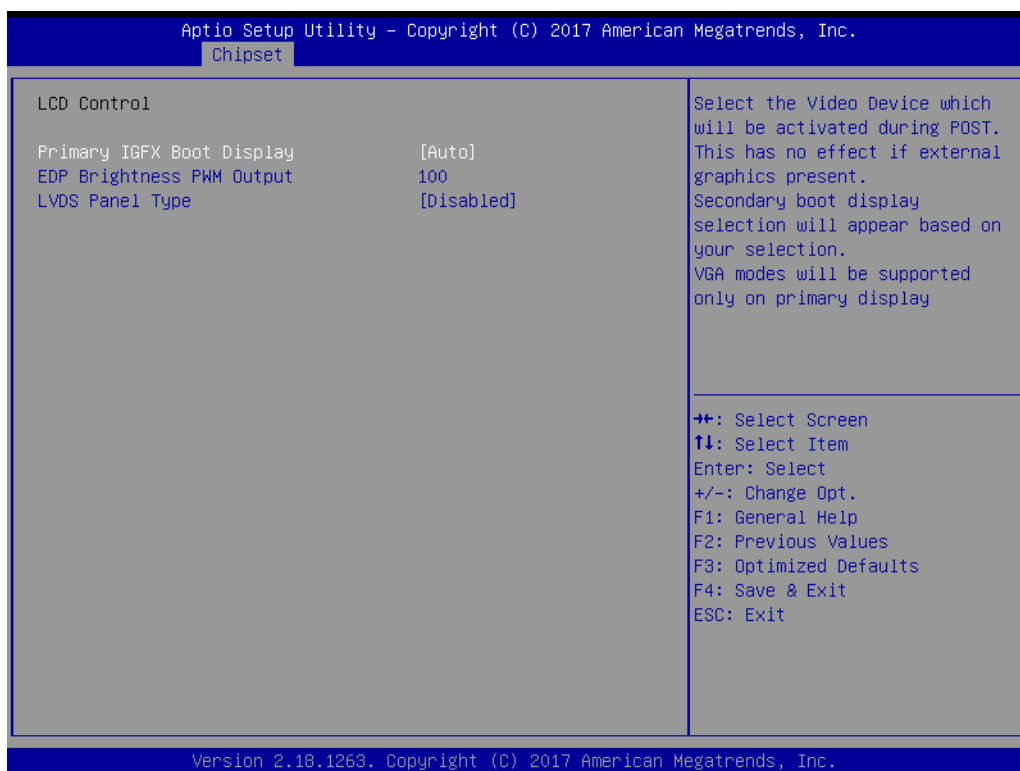


- **Max TOLUD**

This item allows users to select the maximum value of TOLUD.

- **PCIE VGA Workaround**

Enable it if your PCIe card cannot boot to DOS. This is for Testing only.



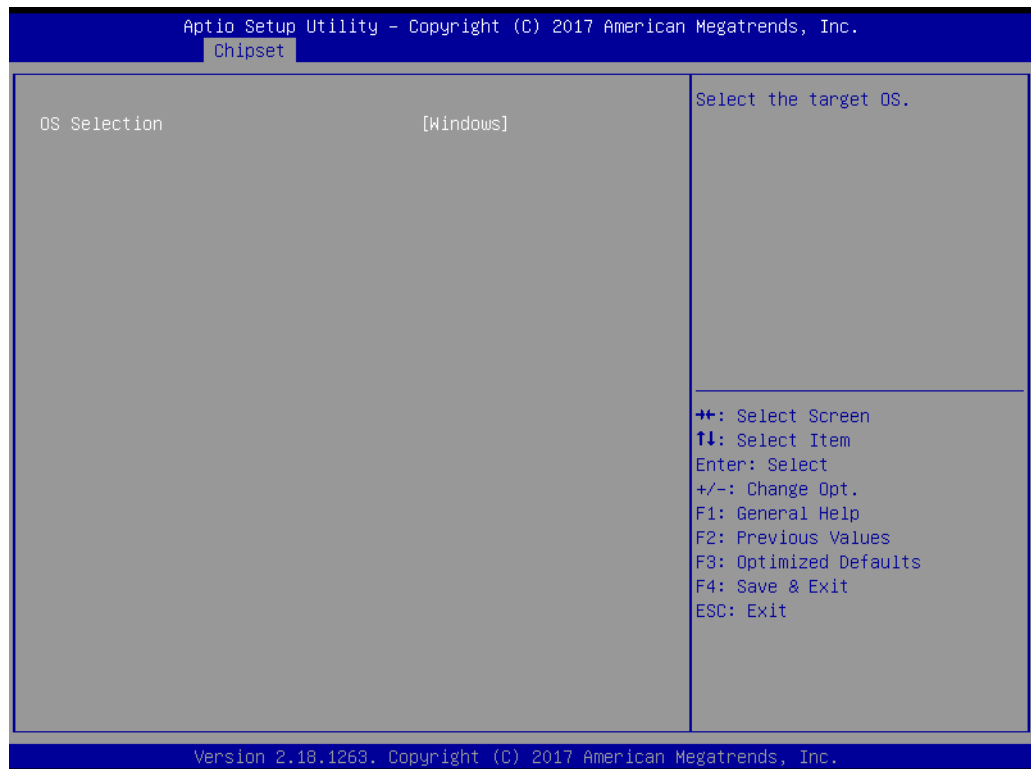
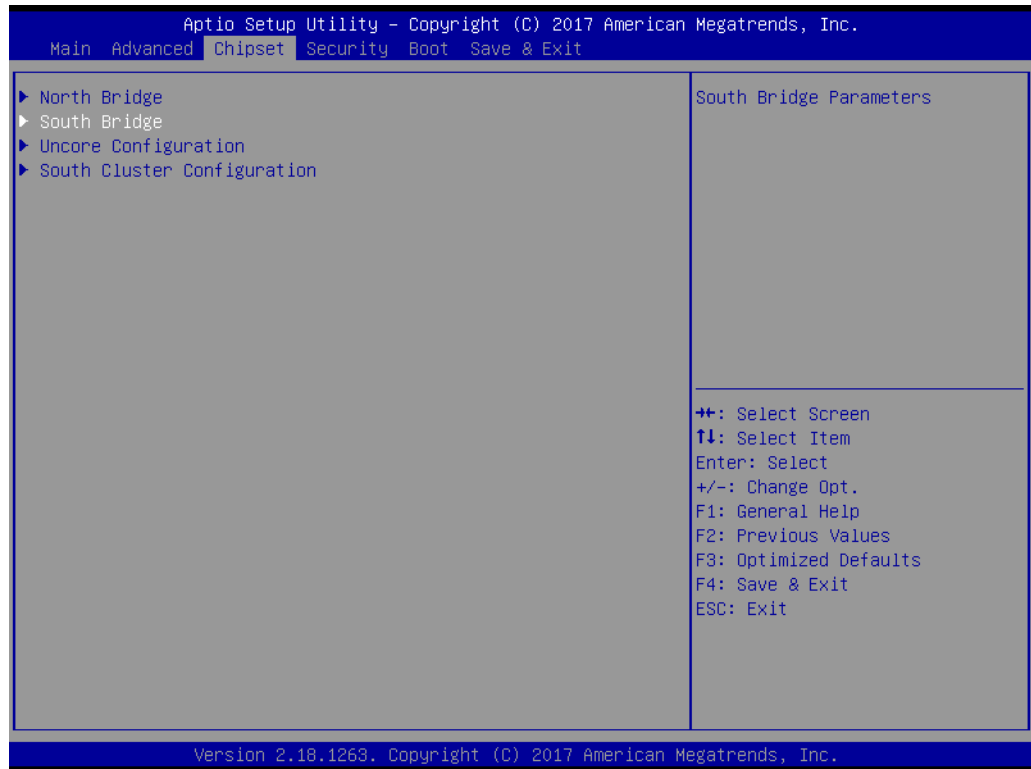
- **Primary IGFX Boot Display**

Select the Video Device which will be activated during POST. This has no effect if external graphics present. Secondary boot display selection will appear based on your selection. VGA modes will be supported only on primary display.

- **LVDS Panel Type**

LVDS Panel Type selection.

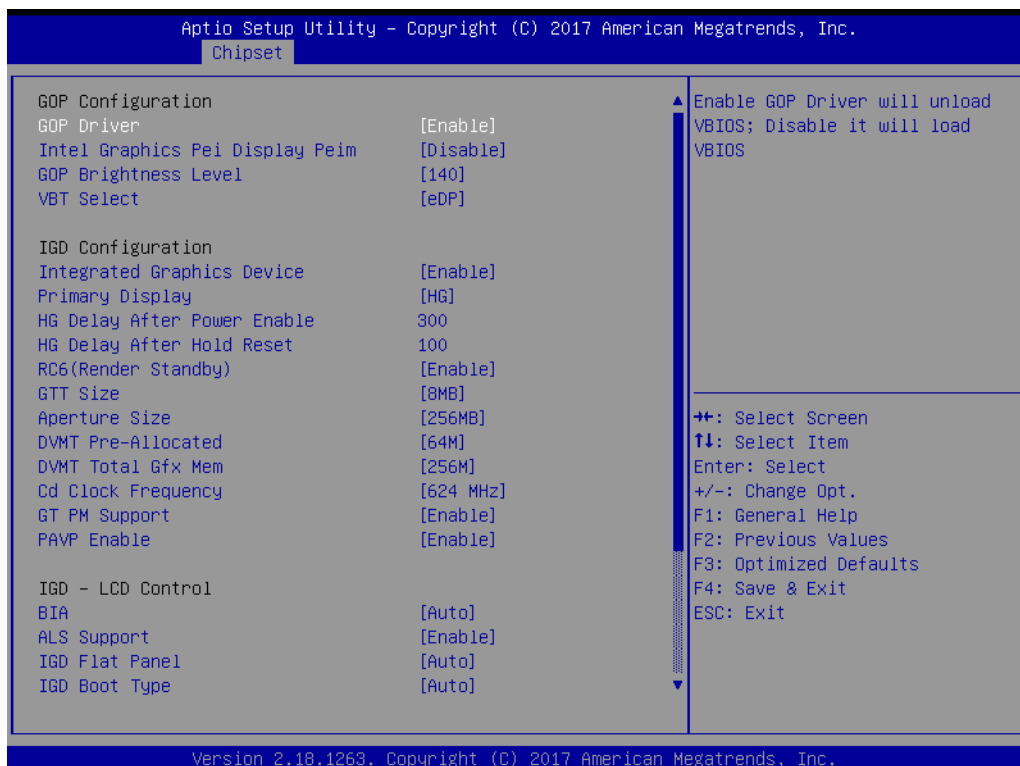
### 3.2.3.2 South Bridge



- **OS Selection**  
Select the target OS.



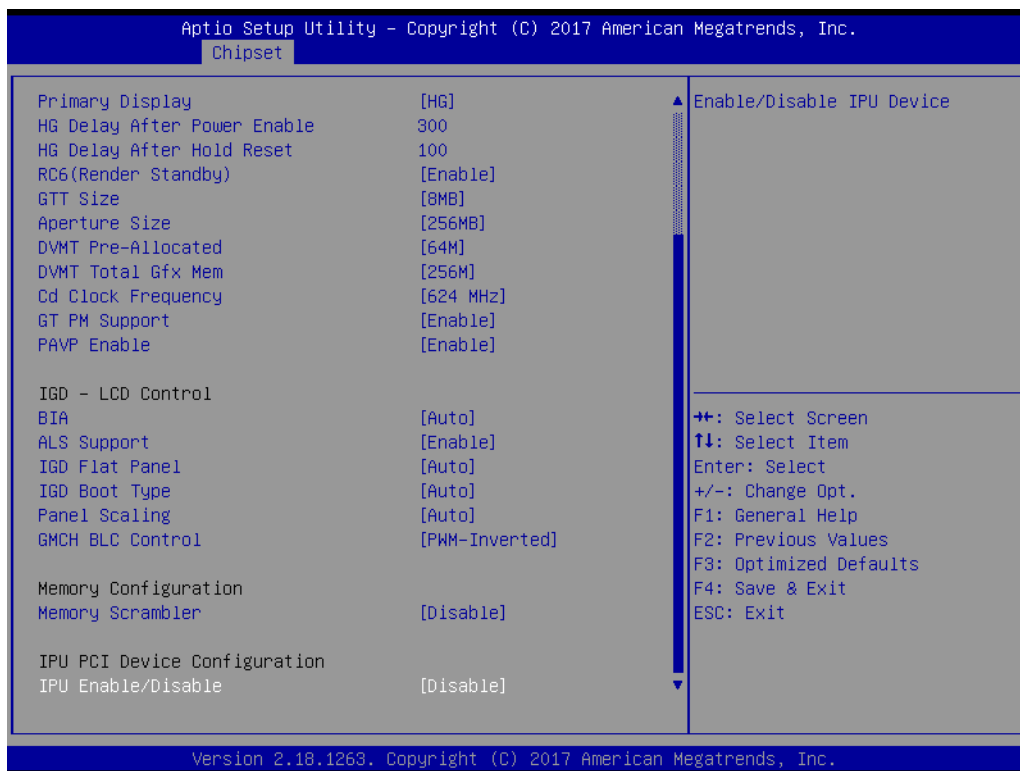
### 3.2.3.3 Uncore Configuration



#### **GOP Configuration**

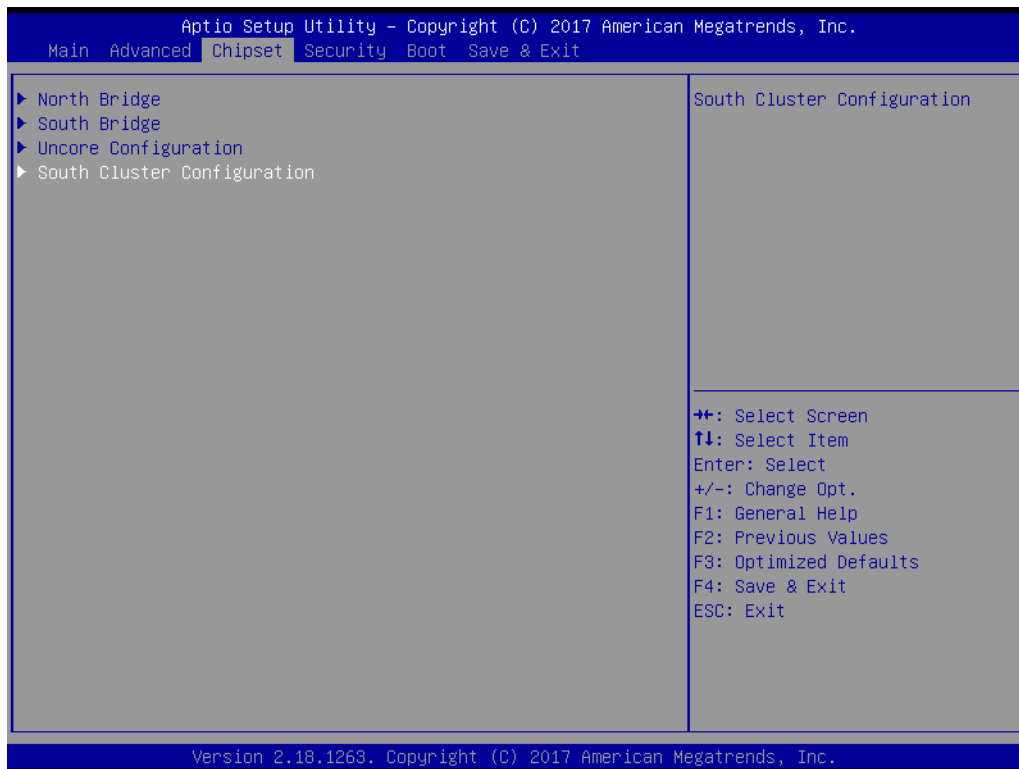
- **GOP Driver**  
Enable GOP Driver will unload VBIOS; Disable it will load VBIOS.
- **Intel Graphics Pei Display Peim**

- 
- Enable/Disable Pei (Early) Display.
  - **GOP Brightness Level**  
Set GOP Brightness level; value ranges from 0~255.
  - **VBT Select**  
Select VBT for GOP driver.  
IGD Configuration.
  - **Integrated Graphics Device**  
Enable: Enable Integrated Graphics Device (IGD) when selected as the primary video adaptor.  
Disable: Always disable IGD.
  - **Primary Display**  
Select which of IGD/PCI Graphics device should be Primary Display.
  - **RC6 (Render Standby)**  
Check to enable render standby support, RC6 should be enabled if S0ix is enabled. This item will be read only if S0ix is enabled.
  - **GTT Size**  
Select the GTT Size.
  - **Aperture Size**  
Select the Aperture Size.
  - **DVMT Pre-Allocated**  
Select DVMT 5.0 Pre-Allocated (Fixed) Graphics Memory size used by the Internal Graphics Device.
  - **DVMT Total Gfx Mem**  
Select DVMT 5.0 Total Graphic Memory size used by the Internal Graphics Device.
  - **Cd Clock Frequency**  
Select the highest Cd Clock frequency supported by the platform.
  - **GT PM Support**  
Enable/Disable GT PM Support.
  - **PAVP Enable**  
Enable/Disable PAVP.
  - **BIA**  
Auto: GMCH Use VBIOS Default;  
Level n: Enabled with Selected Aggressiveness Level.
  - **ALS Support**  
Valid only for ACPI.
  - **IGD Flat Panel**  
Select IGD Flat Panel.
  - **IGD Boot Type**  
Select preference for Integrated Graphics Device (IGD) display interface used when system boots.

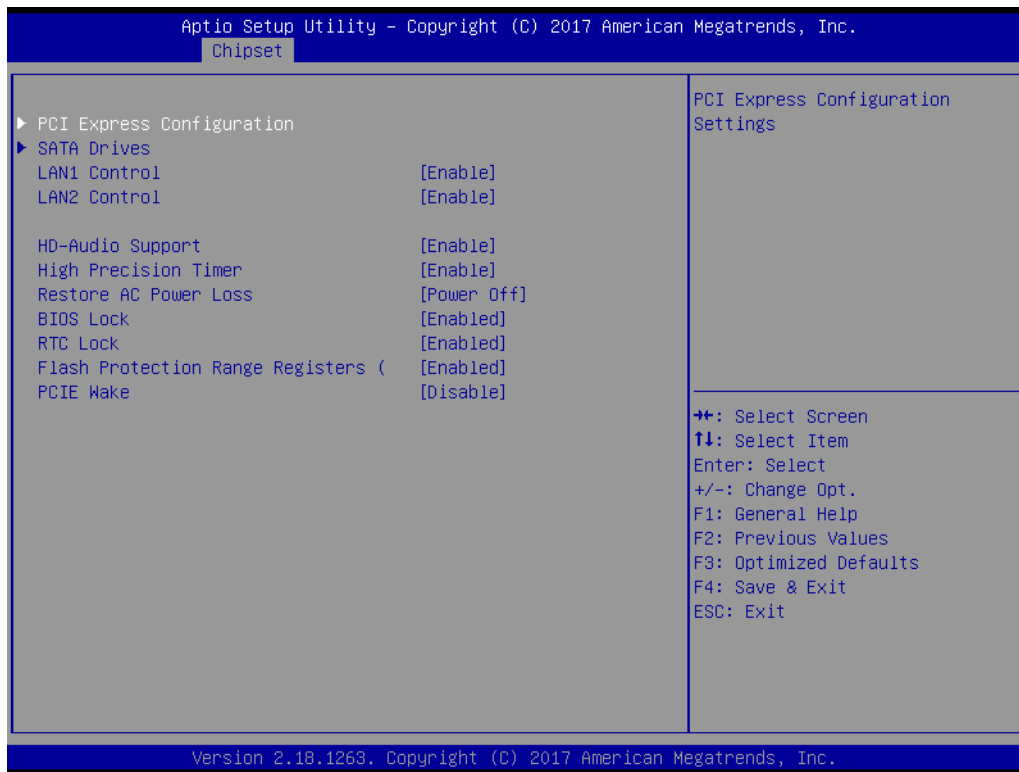


- **Panel Scaling**  
Select Panel Scaling.
- **GMCH BLC Control**  
Back Light Control Setting.
- **Memory Configuration**
- **Memory Scrambler**  
Enable/Disable Memory Scrambler support.
- **IPU PCI Device Configuration**
- **IPU Enable/Disable**  
Enabled or disabled IPU Device.

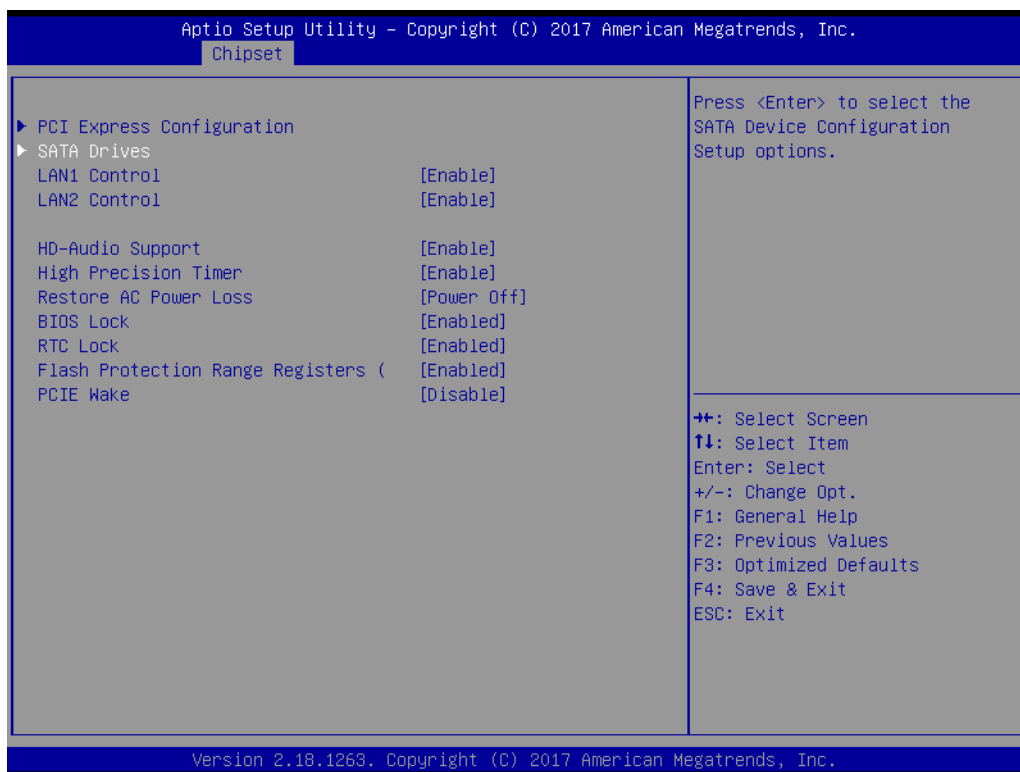
### 3.2.3.4 South Cluster Configuration



### ■ PCI Express Configuration



## ■ SATA Drives



### – Chipset SATA

Enables or disables the chipset SATA controller. The chipset SATA controller supports the 2 black internal SATA ports (up to 3Gb/s supported per port).

### – SATA Mode Selection

This item allows users to select mode of SATA controller(s).

### – Aggressive LPM Support

This item allows users to enable or disable Aggressive LPM support.

### – Port 1

This item allows users to enable or disable the Serial-ATA Port 1 device.

### – Spin Up Device

This item allows users to enable or disable the Spin Up Device.

### – SATA Device Type

Identify the SATA port is connected to Solid State Drive or Hard Disk Drive.

### – Port 2

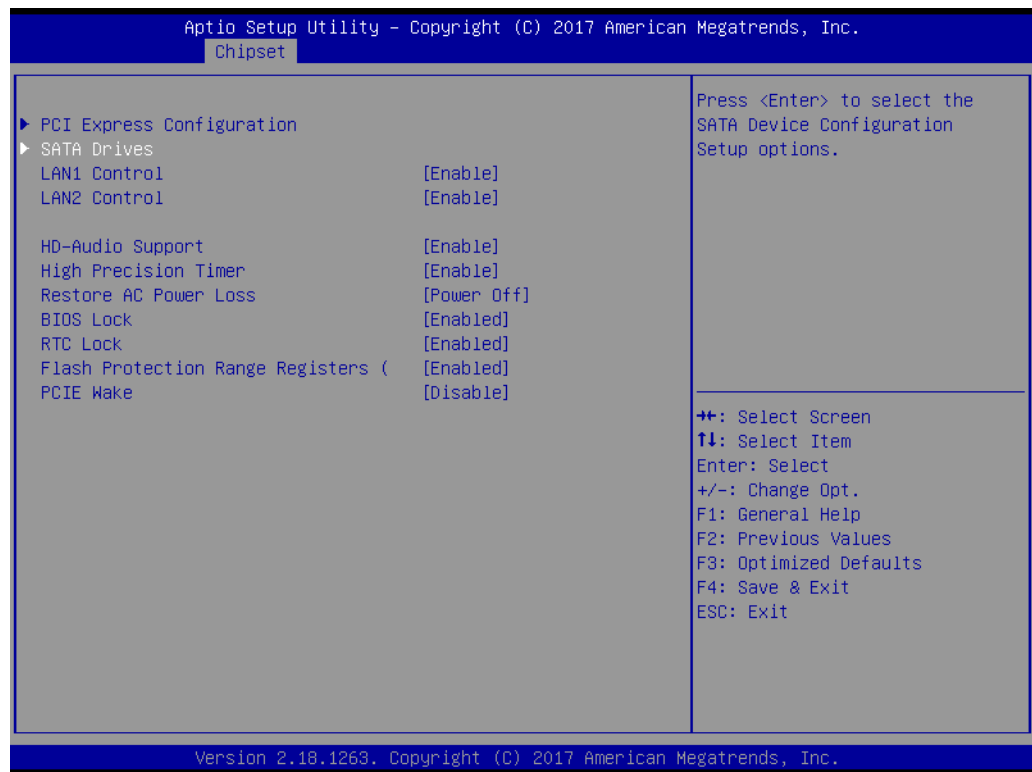
This item allows users to enable or disable the Serial-ATA Port 2 device.

### – Spin Up Device

This item allows users to enable or disable the Spin Up Device.

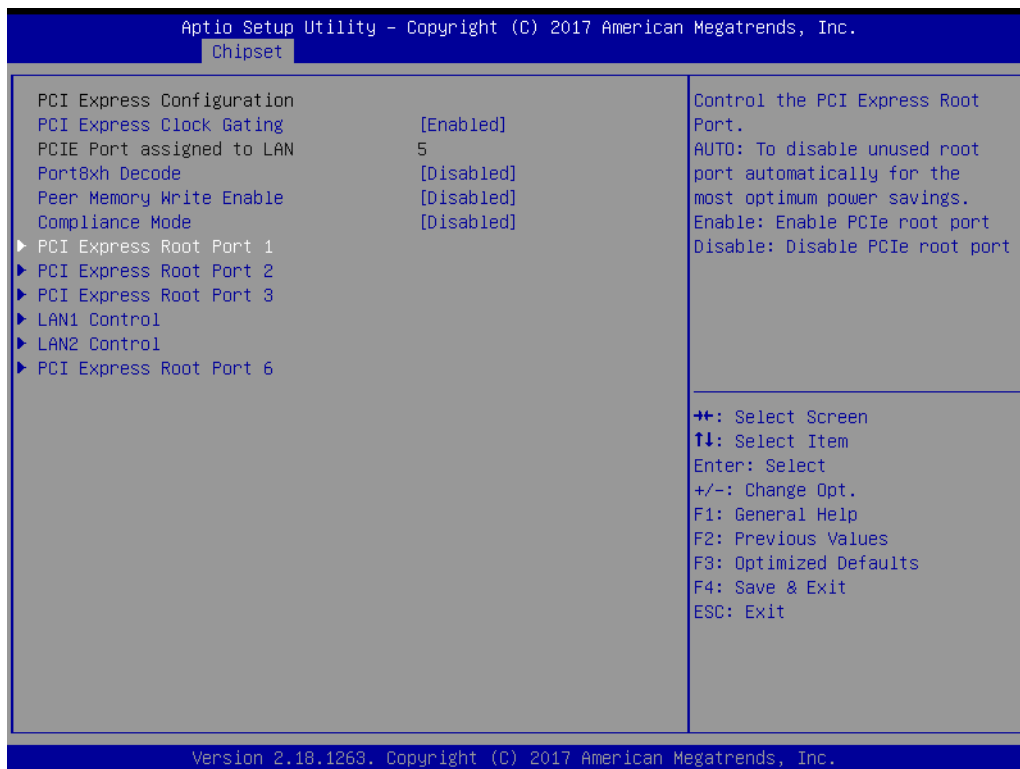
### – SATA Device Type

Identify the SATA port is connected to Solid State Drive or Hard Disk Drive.



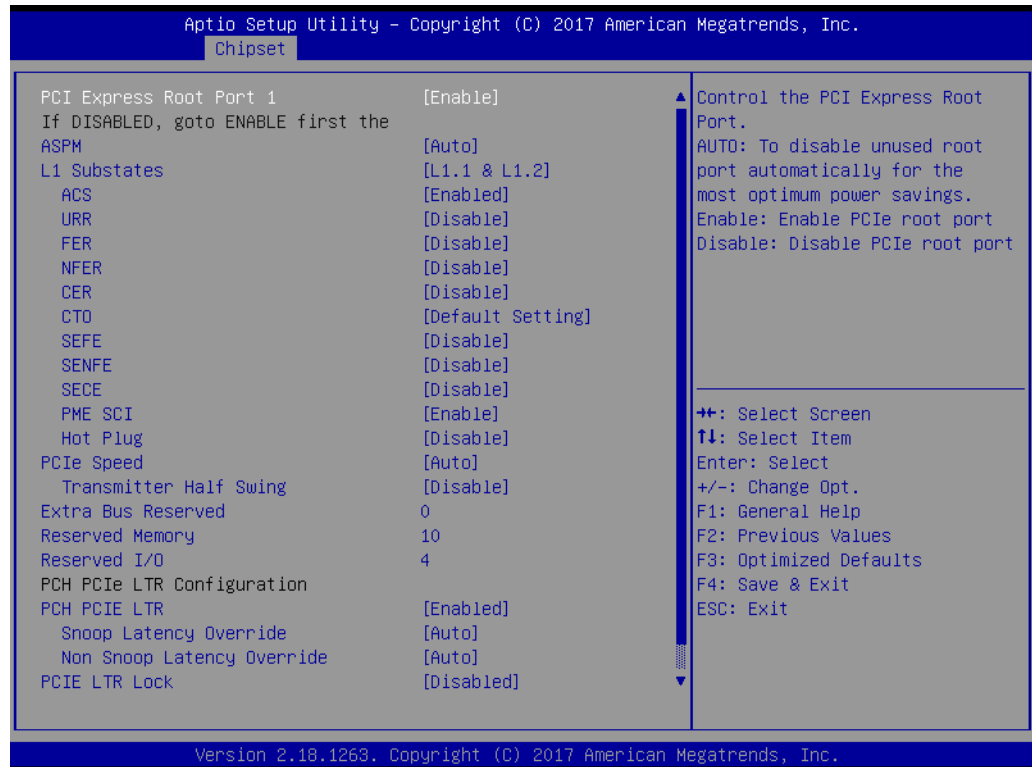
- **LAN1 Control**  
Enable or disable the LAN 1 control.
- **LAN2 Control**  
Enable or disable the LAN 2 control.
- **HD-Audio Support**  
Enable or disable HD-Audio Support.
- **High Precision Timer**  
Enable or disable High Precision Timer
- **Restore AC Power Loss**  
This item allows users to select off, on and last state.
- **BIOS Lock**  
Enable/Disable the BIOS Lock Enable feature.
- **RTC Lock**  
Enable or disable bytes 38h-3Fh in the upper and lower 128-byte bank of RTC RAM lockdown.
- **Flash Protection Range Registers**  
Enable or disable Flash Protection Range Registers.
- **PCIE Wake**  
Enable or disable PCIE to wake the system from S5.

## ■ PCI Express Configuration



- **PCI Express Clock Gating**  
Enable or disable PCI Express Clock Gating.
- **Port8xh Decode**  
Enable or disable Port8xh Decode.
- **Peer Memory Write Enable**  
Enable or disable Peer Memory Write.
- **Compliance Mode**  
Enable or disable Compliance Mode.

- **PCI Express Root Port 1/2/3/6**



- **PCI Express Root Port 1/2/3/6**

Control the PCI Express Root Port.

- **ASPM**

PCI Express Active State Power Management settings.

- **L1 Substates**

PCI Express L1 Substates settings.

- **ACS**

Enable/Disable Access Control Services Extended Capability.

- **URR**

PCI Express Unsupported Request Reporting Enable/Disable.

- **FER**

PCI Express Device Fatal Error Reporting Enable/Disable.

- **NFER**

PCI Express Device Non-Fatal Error Reporting Enable/Disable.

- **CER**

PCI Express Device Correctable Error Reporting Enable/Disable.

- **CTO**

PCI Express Completion Timer TO Enable/Disable.

- **SEFE**

Root PCI Express System Error on Fatal Error Enable/Disable.

- **SENF**

Root PCI Express System Error on Non-Fatal Error Enable/Disable.

- **SECE**

Root PCI Express System Error on Correctable Error Enable/Disable.

- **PME SCI**

PCI Express PME SCI Enable/Disable.



- **Hot Plug**

PCI Express Hot Plug Enable/Disable.

- **PCIe Speed**

Configure PCIe Speed.

- **Transmitter Half swing**

Transmitter Half Swing Enable/Disable.

- **PCH PCIE LTR**

PCH PCIE Latency Reporting Enable/Disable.

- **Snoop Latency Override**

Snoop Latency Override for PCH PCIE.

Disabled: Disable override.

Manual: Manually enter override values.

Auto (default): Maintain default BIOS flow.

- **Non Snoop Latency Override**

Non Snoop Latency Override for PCH PCIE.

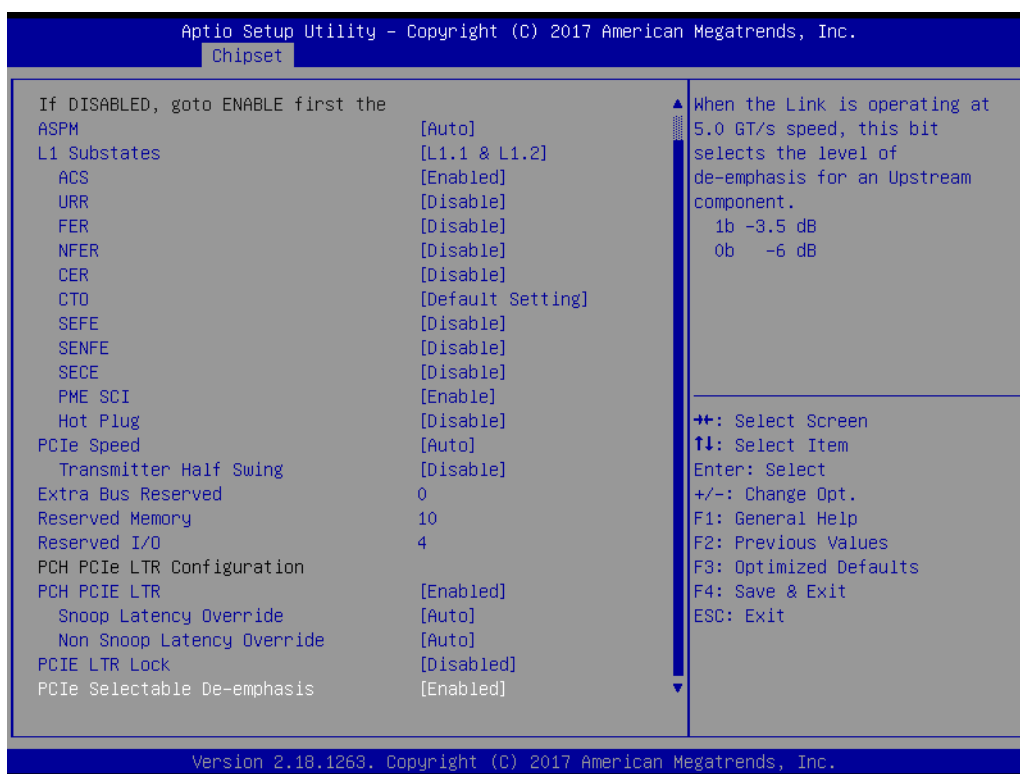
Disabled: Disable override.

Manual: Manually enter override values.

Auto (default): Maintain default BIOS flow.

- **PCIe LTR Lock**

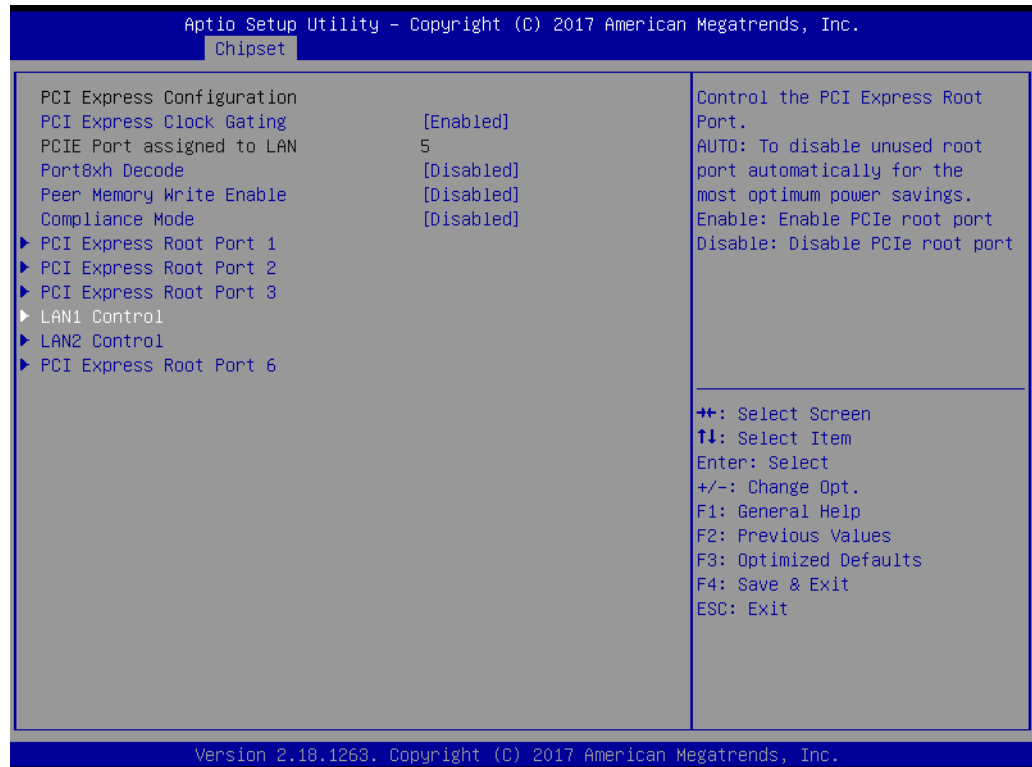
PCIe LTR Configuration Lock.



- **PCIe Selectable De-emphasis**

When the Link is operating at 5.0 GT/s speed, this bit selects the level of de-emphasis for an Upstream component.

## ■ LAN1/LAN2 Control



### – ASPM

PCI Express Active State Power Management settings.

### – L1 Substates

PCI Express L1 Substates settings.

### – ACS

Enable/Disable Access Control Services Extended Capability.

### – URR

PCI Express Unsupported Request Reporting Enable/Disable.

### – FER

PCI Express Device Fatal Error Reporting Enable/Disable.

### – NFER

PCI Express Device Non-Fatal Error Reporting Enable/Disable.

### – CER

PCI Express Device Correctable Error Reporting Enable/Disable.

### – CTO

PCI Express Completion Timer TO Enable/Disable.

### – SEFE

Root PCI Express System Error on Fatal Error Enable/Disable.

### – SENFE

Root PCI Express System Error on Non-Fatal Error Enable/Disable.

### – SECE

Root PCI Express System Error on Correctable Error Enable/Disable.

### – PME SCI

PCI Express PME SCI Enable/Disable.

### – Hot Plug

PCI Express Hot Plug Enable/Disable.

- **PCIe Speed**

Configure PCIe Speed.

- **Transmitter Half swing**

Transmitter Half Swing Enable/Disable.

- **PCH PCIE LTR**

PCH PCIE Latency Reporting Enable/Disable.

- **Snoop Latency Override**

Snoop Latency Override for PCH PCIE.

Disabled: Disable override.

Manual: Manually enter override values.

Auto (default): Maintain default BIOS flow.

- **Non Snoop Latency Override**

Non Snoop Latency Override for PCH PCIE.

Disabled: Disable override.

Manual: Manually enter override values.

Auto (default): Maintain default BIOS flow.

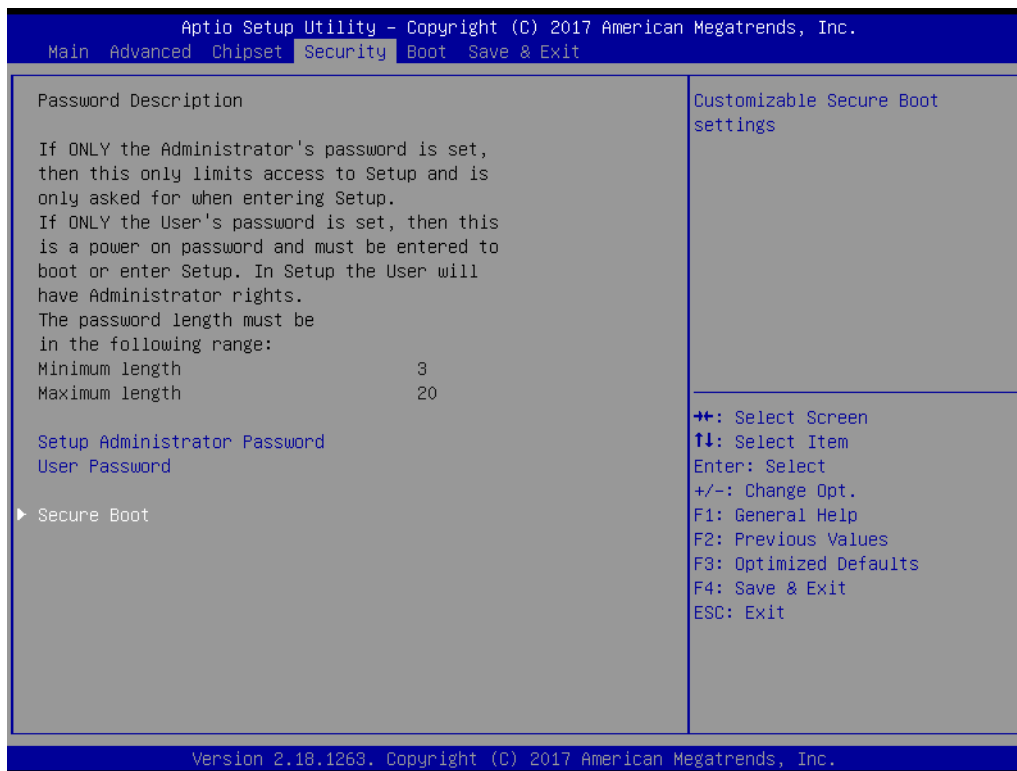
- **PCIe LTR Lock**

PCIe LTR Configuration Lock.

- **PCIe Selectable De-emphasis**

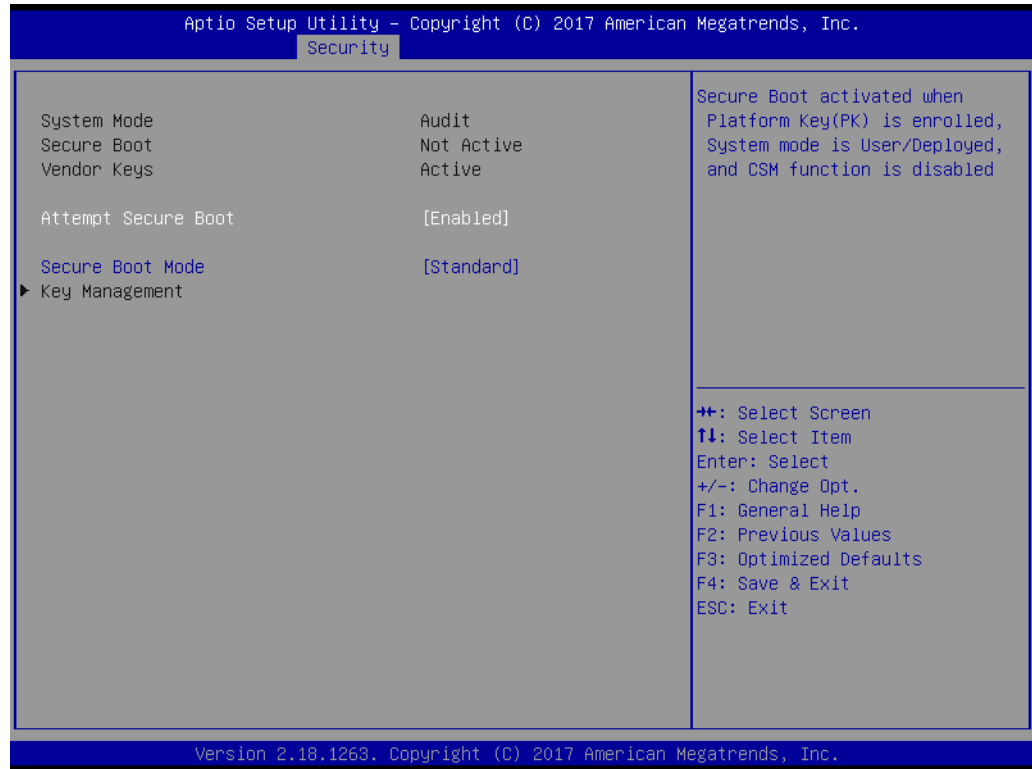
When the Link is operating at 5.0 GT/s speed, this bit selects the level of de-emphasis for an upstream component.

### 3.2.4 Security



Select Security Setup from the AIMB-217 Setup main BIOS setup menu. All Security Setup options, such as password protection and virus protection are described in this section. To access the sub menu for the following items, select the item and press <Enter>: Change Administrator / User Password.

### 3.2.4.1 Secure Boot



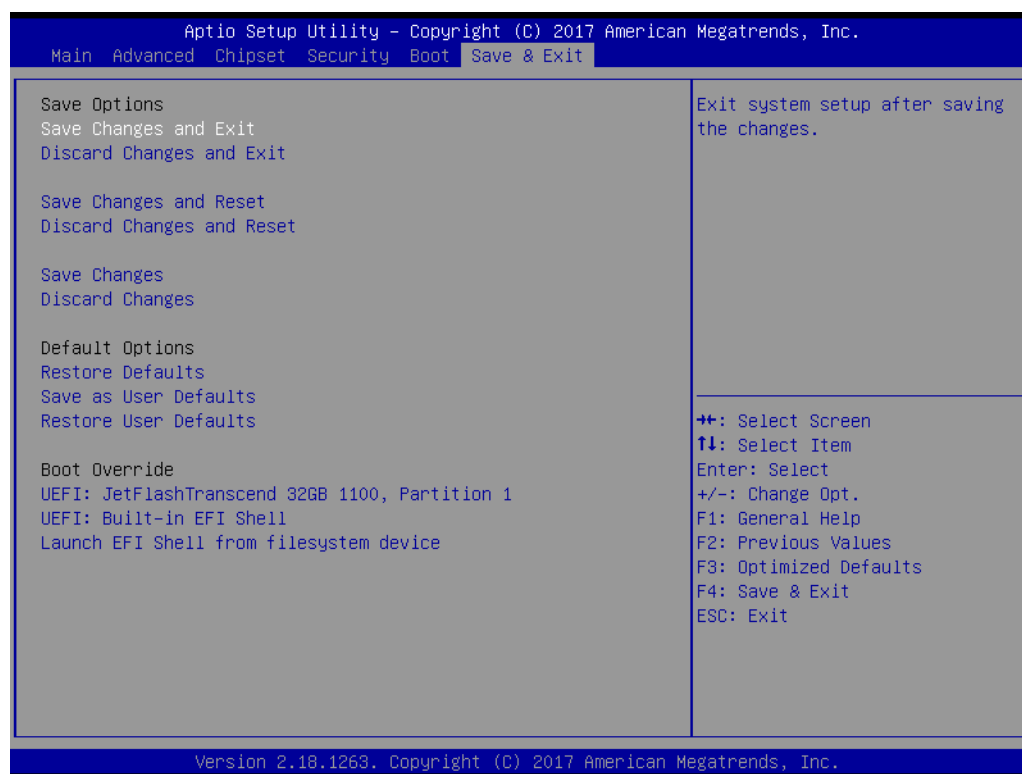
- **Attempt Secure Boot**  
Secure Boot activated when platform key(PK) is enrolled, system mode is user/ deployed, and CSM function is disabled.
- **Secure Boot Mode**  
Secure Boot mode - Custom & Standard, set UEFI Secure Boot Mode to STAN- DARD mode or CUSTOM mode, this change is effect after save. And after reset, the mode will return to STANDARD mode.

### 3.2.5 Boot



- **Bootup NumLock State**  
Select the keyboard Numlock state.
- **Quiet Boot**  
Enables or disableds Quiet Boot option.

## 3.2.6 Save and Exit



- **Save Changes and Exit**  
This item allows users to exit system setup after saving changes.
- **Discard Changes and Exit**  
This item allows users to exit the system setup without saving changes.
- **Save Changes and Reset**  
This item allows users to reset the system setup after saving changes.
- **Discard Changes and Reset**  
This item allows users to reset the system setup without saving changes.
- **Save Changes**  
This item allows users to save changes done so far to any of the setup options.
- **Discard Changes**  
This item allows users to discard changes done so far to any of the setup options.
- **Restore Defaults**  
This item allows users to restore/load the default values for all options.
- **Save as User Defaults**  
This item allows users to save changes done so far as user defaults.
- **Restore User Defaults**  
This item allows users to restore the user defaults for all options.
- **Launch EFI Shell From a File system Device**  
Attempts to Launch EFI Shell application (Shell.efi) from one of the available filesystem devices.

# Chapter 4

Software and Service  
Introduction

## 4.1 Introduction

The mission of Advantech Embedded Software Services is to “enhance users’ quality of life with Advantech platforms and Microsoft® Windows® embedded technology”. We equip Advantech platforms with Windows® embedded software products to more effectively support the embedded computing community. This eliminates the hassle of dealing with multiple vendors (hardware suppliers, system integrators, and embedded OS distributors) for specific projects. Our aim is to make Windows® embedded software solutions widely available to the embedded computing community.

## 4.2 Value-Added Software Services

Software API: An interface that defines the ways in which an application program may request services from libraries and/or operating systems. This software provides not only the underlying drivers required, but also a rich set of user-friendly, intelligent, and integrated interfaces that speed development, enhance security, and offer add-on value for Advantech platforms. Furthermore, this software serves as a catalyst between developers and solutions, making Advantech embedded platforms easier and simpler to adopt and operate with customer applications.

### 4.2.1 Software API

#### 4.2.1.1 Control

##### GPIO



General purpose input/output is a flexible parallel interface that allows various custom connections. This interface also enables users to monitor the level of signal input or set the output status to switch the device on or off. Our API also provides programmable GPIO, enabling developers to dynamically set the GPIO input or output status.

##### SMBus



SMBus is a system management bus defined by Intel Corporation in 1995. This interface is used in personal computers and servers for low-speed system management communications. The SMBus API allows developers to interface with an embedded system environment and transfer serial messages using SMBus protocols, facilitating multiple simultaneous device control.

#### 4.2.1.2 Display

##### Brightness Control



The Brightness Control API allows developers to access embedded devices and easily control brightness.



### Backlight



The Backlight API allows developers to control the backlight (screen) in embedded devices.

#### 4.2.1.3 Monitor

### Watchdog



A watchdog timer is a device that performs a specific operation after a specified period of time when a malfunction occurs and the system cannot recover on its own. A watchdog timer can be programmed to perform a warm booting (system restart) after a certain number of seconds.

### Hardware Monitor



The Hardware Monitor API is a system health supervision API that inspects certain condition indices, such as fan speed, temperature, and voltage.

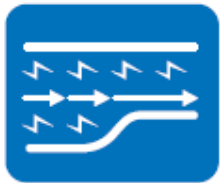
#### 4.2.1.4 Power Saving

### CPU Speed



This feature uses Intel SpeedStep® Technology to reduce the system power consumption. The system automatically adjusts the CPU speed according to the system load.

### System Throttling

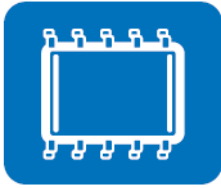


This refers to a series of methods for reducing system power consumption by lowering the clock frequency. This API allows users to adjust the clock frequency from 87.5% to 12.5%.

---

## 4.2.2 Software Utility

### BIOS Flash



The BIOS Flash utility allows customers to update the flash ROM BIOS version, or backup the current BIOS by copying the configuration from the flash chip to a file on the users' disk. The BIOS Flash utility also features a command line version and API for rapid implementation in customized applications.

### Embedded Security ID



Embedded applications are the most important responsibilities for system integrators because they contain valuable intellectual property, design knowledge, and innovations, and are easily copied. This Embedded Security ID utility offers reliable security functions that allow users to secure application data within embedded BIOS.

### Monitoring



The Monitoring API is a utility that allows users to monitor the system health indicators, such as voltage, CPU and system temperature, and fan speed. These system values are crucial. If critical errors occur and are not solved immediately, permanent damage to the device may result.

# Chapter 5

Chipset Software  
Install Utility

---

## 5.1 Before Installation

Before installing the enhanced display drivers and utility software, please read the instructions provided in this chapter carefully. The drivers for AIMB-217 are provided on Advantech support website: <http://support.advantech.com/Support/>. This driver will guide and link users to the utilities and drivers required for Microsoft Windows-based systems. Software updates can be accessed from Microsoft\* software service packs.

**Note!** *The files on the website are compressed. Do not attempt to install the drivers by copying the files manually. The Setup program provided must be used to install the drivers.*



Please note, for most display drivers, the relevant software application must be installed on the system before enhanced display drivers can be installed. In addition, for many of the installation procedures, user familiarity with both the relevant software applications and operating system commands is assumed. Thus, users are advised to review relevant operating system commands and pertinent sections of the application software user manual before attempting installation.

## 5.2 Introduction

The Intel® Chipset Software Installation (CSI) utility installs the Microsoft Windows INF files that specify the chipset component configuration on the OS. This is essential to enable the following features and functionality:

- Core PCI PnP services
- Serial ATA interface support
- USB support
- Identification of Intel® chipset components in the device manager

**Note!** *This utility is used for the following versions of Windows, and it has to be installed before installing all the other drivers:*



- Windows 10 (64 bit)

# Chapter 6

## Graphics Setup

## 6.1 Introduction

To benefit from the Intel® Pentium N4200, Celeron N3350, Atom x7-E3950 integrated graphics controller, users must install the graphics driver.

## 6.2 Windows 10

**Note!** Before installing this driver, ensure the CSI utility is installed on the system. See Chapter 5 for information regarding installing the CSI utility.



Download the driver from website on your computer. Navigate to the "Graphics" folder and click "setup.exe" to complete the installation of the drivers for Windows 10.

### Win10(64bit) Driver For AIMB-217

Solution : Win10(64bit) Driver For AIMB-217

Download File	Released Date	Download Site	
AIMB-217_Others_Win10(64bit).zip	2017-01-18	Primary	Secondary
AIMB-217_Intel Super IO_Win10(64bit).zip	2017-01-18	Primary	Secondary
AIMB-217_COM_Win10(64bit).zip	2017-01-18	Primary	Secondary
AIMB-217_Chipset_Win10(64bit).zip	2017-01-18	Primary	Secondary
AIMB-217_Realtek LAN_Win10(64bit).zip	2017-01-18	Primary	Secondary
AIMB-217_Intel TXE_Win10(64bit).zip	2017-01-17	Primary	Secondary
AIMB-217_Graphics_Win10(64bit).zip	2017-01-17	Primary	Secondary
AIMB-217_Audio_Win10(64bit).zip	2017-01-17	Primary	Secondary

# Chapter 7

## LAN Configuration

## 7.1 Introduction

The AIMB-217 system features dual Gigabit Ethernet LANs via dedicated PCI Express x1 lanes (Realtek RTL8111G (LAN1) and Realtek RTL8111G (LAN2)) that offer a bandwidth of up to 500 MB/sec, eliminating bottlenecks in the flow of network data by incorporating Gigabit Ethernet at 1000 Mbps.

## 7.2 Features

- Integrated 10/100/1000 Mbps transceiver
- 10/100/1000 Mbps triple-speed MAC
- High-speed RISC core with 24-KB cache
- On-chip voltage regulation
- Wake-on-LAN (WOL) support
- PCI Express X1 host interface

## 7.3 Installation

**Note!** Before installing LAN drivers, ensure the CSI utility is installed on the system. See Chapter 5 for information regarding installing the CSI utility.



The Realtek 8111G (LAN1) and Realtek 8111G (LAN2) Gigabit integrated controllers support all major network operating systems. However, the installation procedure varies between systems. Please follow the driver setup procedure instructions specific to the operating system installed.

## 7.4 Windows 10 Driver Setup (Realtek 8111G)

Download the driver from website on your computer. Navigate to the "AIMB-217 Realtek LAN" folder and click "setup.exe" to complete the installation of the drivers.

Win10(64bit) Driver For AIMB-217

Solution : Win10(64bit) Driver For AIMB-217

Download File	Released Date	Download Site	
AIMB-217_Others_Win10(64bit).zip	2017-01-18	Primary	Secondary
AIMB-217_Intel Super IO_Win10(64bit).zip	2017-01-18	Primary	Secondary
AIMB-217_COM_Win10(64bit).zip	2017-01-18	Primary	Secondary
AIMB-217_Chipset_Win10(64bit).zip	2017-01-18	Primary	Secondary
AIMB-217_Realtek LAN_Win10(64bit).zip	2017-01-18	Primary	Secondary
AIMB-217_Intel TXE_Win10(64bit).zip	2017-01-17	Primary	Secondary
AIMB-217_Graphics_Win10(64bit).zip	2017-01-17	Primary	Secondary
AIMB-217_Audio_Win10(64bit).zip	2017-01-17	Primary	Secondary



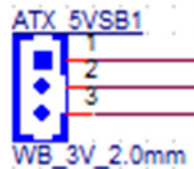
# Appendix **A**

## Pin Assignments

## A.1 Pin Assignments

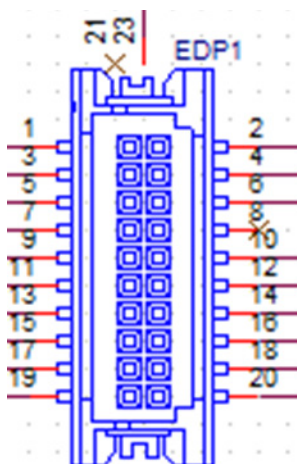
**Table A.1: ATX\_5VSB1**

PIN	PIN_NAME
1	+V5SB_IN
2	GND
3	PS_ON#



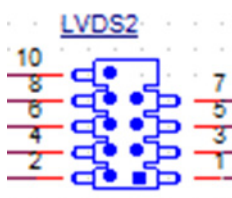
**Table A.2: EDP1**

PIN	PIN_NAME
1	GND
2	GND
3	eDP_z_TX0-
4	eDP_z_TX3-
5	eDP_z_TX0+
6	eDP_z_TX3+
7	GND
8	NC
9	eDP_z_TX1-
10	GND
11	eDP_z_TX1+
12	eDP_z_AUX-
13	GND
14	eDP_z_AUX+
15	eDP_z_TX2-
16	GND
17	eDP_z_TX2+
18	eDP1_HPD
19	VDD_EDP
20	VDD_EDP



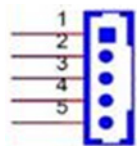
**Table A.3: LVDS2**

PIN	PIN_NAME
1	GND
2	+V5
3	LVDS2_BKLTEN
4	LVDS2_GPIO3
5	LVDS2_VDD_EN
6	LVDS2_GPIO2
7	LVDS_RESET
8	LVDS2_GPIO1
9	NC
10	LVDS2_GPIO0



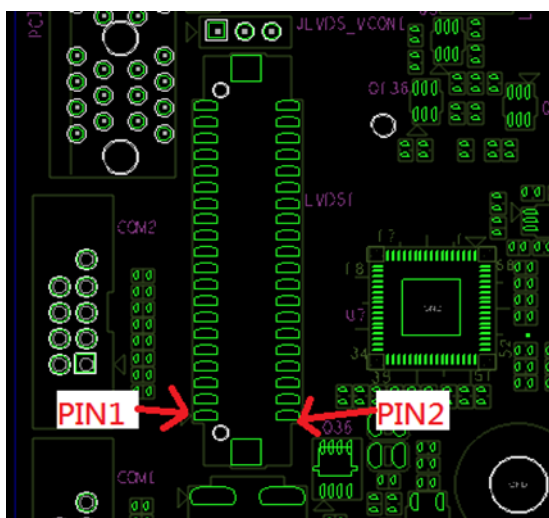
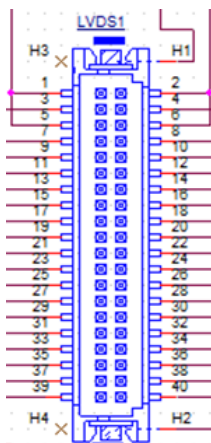
**Table A.4: INV2**

PIN	PIN_NAME
1	+V12_INV2
2	GND
3	INV2_ENBKL
4	INV2_VBR
5	+V5_INV2



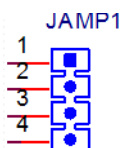
**Table A.5: LVDS1**

<b>PIN</b>	<b>PIN_NAME</b>
1	VDD_LVDS1
2	VDD_LVDS1
3	LVDS_DET#
4	GND
5	VDD_LVDS1
6	VDD_LVDS1
7	LVDS1_A0N
8	LVDS1_A4N
9	LVDS1_A0P
10	LVDS1_A4P
11	GND
12	GND
13	LVDS1_A1N
14	LVDS1_A5N
15	LVDS1_A1P
16	LVDS1_A5P
17	GND
18	GND
19	LVDS1_A2N
20	LVDS1_A6N
21	LVDS1_A2P
22	LVDS1_A6P
23	GND
24	GND
25	LVDS1_CLK1N
26	LVDS1_CLK2N
27	LVDS1_CLK1P
28	LVDS1_CLK2P
29	GND
30	GND
31	LVDS1_SCD
32	LVDS1_SDD
33	GND
34	GND
35	LVDS1_A3N
36	LVDS1_A7N
37	LVDS1_A3P
38	LVDS1_A7P
39	LVDS1_y_ENBKL
40	LVDS1_VCON



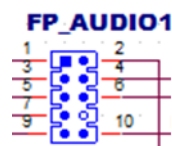
**Table A.6: JAMP1**

PIN	PIN_NAME
1	GND
2	AMP_SIDE-L
3	GND
4	AMP_SIDE-R



**Table A.7: FP\_AUDIO1**

PIN	PIN_NAME
1	MIC2L
2	AGND
3	MIC2R
4	AFP_PRESEN# (Pull Up to +V3.3A)
5	LINE2R
6	MIC2-JD
7	SENSEB
8	
9	LINE2L
10	LINE2-JD



**Table A.8: INV1**

PIN	PIN_NAME
1	+V12_INV1
2	GND
3	INV1_ENBKL
4	INV1_VBR
5	+V5_INV1

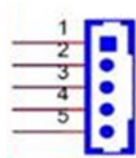


Table A.9: SPDIF\_OUT1

PIN	PIN_NAME
1	+V5
2	NC
3	SPDIF_O
4	GND

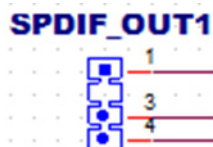
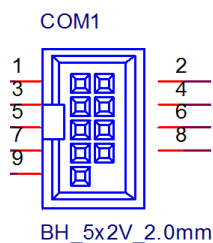


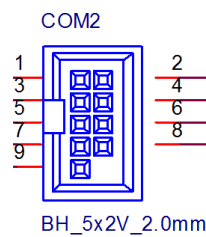
Table A.10: COM1

PIN	PIN_NAME
1	COM1_DCD#
2	COM1_DSR#
3	COM1_SIN
4	COM1_RTS#
5	COM1_SOUT
6	COM1_CTS#
7	COM1_DTR#
8	COM1_RI#
9	GND



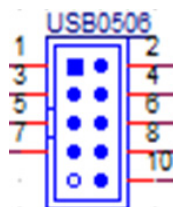
**Table A.11: COM2**

PIN	PIN_NAME
1	COM2_DCD#
2	COM2_DSR#
3	COM2_SIN
4	COM2_RTS#
5	COM2_SOUT
6	COM2_CTS#
7	COM2_DTR#
8	COM2_RI#
9	GND



**Table A.12: USB0506**

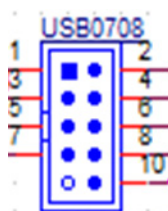
PIN	PIN_NAME
1	USBV45
2	USBV45
3	USB_CM_N4
4	USB_CM_N5
5	USB_CM_P4
6	USB_CM_P5
7	GND
8	GND
10	GND





**Table A.13: USB0708**

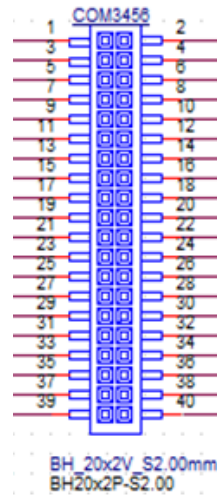
PIN	PIN_NAME
1	USBV67
2	USBV67
3	USB_H0CM_N6
4	USB_H0CM_N7
5	USB_H0CM_P6
6	USB_H0CM_P7
7	GND
8	GND
10	GND

**Table A.14: COM3456**

PIN	PIN_NAME
1	COM3_DCD#
2	COM3_DSR#
3	COM3_SIN
4	COM3_RTS#
5	COM3_SOUT
6	COM3_CTS#
7	COM3_DTR#
8	COM3_RI#
9	GND
10	GND
11	COM4_DCD#
12	COM4_DSR#
13	COM4_SIN
14	COM4_RTS#
15	COM4_SOUT
16	COM4_CTS#
17	COM4_DTR#
18	COM4_RI#
19	GND
20	GND
21	COM5_DCD#
22	COM5_DSR#
23	COM5_SIN
24	COM5_RTS#

**Table A.14: COM3456**

25	COM5_SOUT
26	COM5_CTS#
27	COM5_DTR#
28	COM5_RI#
29	GND
30	GND
31	COM6_DCD#
32	COM6_DSR#
33	COM6_SIN
34	COM6_RTS#
35	COM6_SOUT
36	COM6_CTS#
37	COM6_DTR#
38	COM6_RI_V#
39	GND
40	GND



**Table A.15: SATA\_PWR1,SATA\_PWR2**

PIN	PIN_NAME
1	+V5
2	GND
3	GND
4	+V12

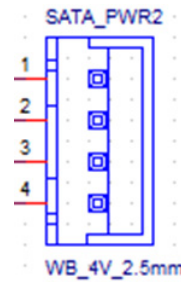
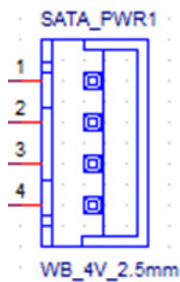


Table A.16: GPIO1

PIN	PIN_NAME
1	SIO_GPIO0
2	SIO_GPIO4
3	SIO_GPIO1
4	SIO_GPIO5
5	SIO_GPIO2
6	SIO_GPIO6
7	SIO_GPIO3
8	SIO_GPIO7
9	VCC_GPIO
10	GND

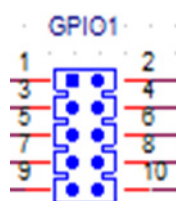
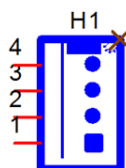


Table A.17: SYSFAN1

PIN	PIN_NAME
1	GND
2	VCC
3	FEEDBACK
4	PWM

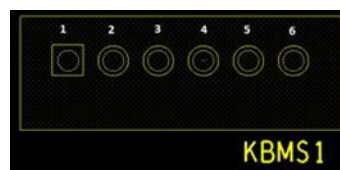


**Table A.18: JFP1**

PIN	PIN_NAME
1	+V5
2	+V3.3
3	FRP_PANSWIN#
4	FRP_SPK2
5	FP_HDD_LED#
6	GND
7	FRP_SPK3
8	SMB_DAT
9	PMU_RSTBTN#
10	FRP_SPK4
11	SMB_CLK
12	GND

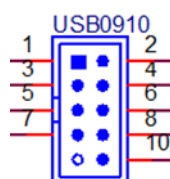
**Table A.19: KBMS1**

PIN	PIN_NAME
1	KB_b_CLK
2	KB_b_DAT
3	MS_b_CLK
4	GND
5	VCC_KBMS
6	MS_b_DAT

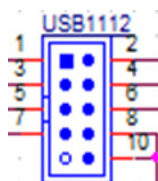


**Table A.20: USB0910**

PIN	PIN_NAME
1	USBV1H89
2	USBV1H89
3	USB_H1CM_N8
4	USB_H1CM_N9
5	USB_H1CM_P8
6	USB_H1CM_P9
7	GND
8	GND
9	NC
10	GND

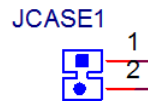
**Table A.21: USB1112**

PIN	PIN_NAME
1	USBV1H1011
2	USBV1H1011
3	USB_H1CM_N10
4	USB_H1CM_N11
5	USB_H1CM_P10
6	USB_H1CM_P11
7	GND
8	GND
9	GND
10	



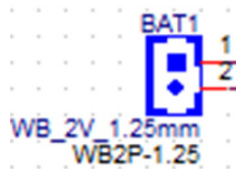
**Table A.22: JCASE1**

PIN	PIN_NAME
1	CASEOP
2	GND



**Table A.23: BAT1**

PIN	PIN_NAME
1	+VBAT_R
2	GND



**Table A.24: ATX12V1**

PIN	PIN_NAME
1	GND
2	GND
3	+VDCIN_ADP_IN
4	+VDCIN_ADP_IN

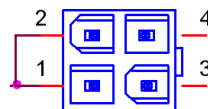
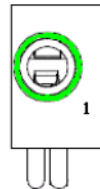


Table A.25: PCIEX1\_1

PIN	PIN_NAME
A1	PRSNT1#
A2	12V_3
A3	12V_4
A4	GND_6
A5	JTAG2
A6	JTAG3
A7	JTAG4
A8	JYAG5
A9	3.3V_2
A10	3.3V_3
A11	PWRGD
A12	GND_7
A13	REFCLK+
A14	REFCLK-
A15	GND_8
A16	HSIP0
A17	HSIN0
A18	GND_9
B1	12V_1
B2	12V_2
B3	RSVD
B4	GND_1
B5	SMCLK
B6	SMDAT
B7	GND_2
B8	3.3V_1
B9	JTAG1
B10	3.3VAUX
B11	WAKE#
B12	RVSD
B13	GND_3
B14	HSOP0
B15	HSOP0
B16	GND_4
B17	PRSNT2#
B18	GND_5

**Table A.26: AUDIO1**

<b>PIN</b>	<b>PIN_NAME</b>
1	AGND
2	LINEOL
3	FRONT-JD
4	LINEOR
5	AGND

**Table A.27: HDMI1**

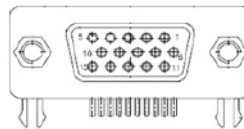
<b>PIN</b>	<b>PIN_NAME</b>
1	HDMI_CON_DP2
2	GND
3	HDMI_CON_DN2
4	HDMI_CON_DP1
5	GND
6	HDMI_CON_DN1
7	HDMI_CON_DP0
8	GND
9	HDMI_CON_DN0
10	HDMI_CON_CKP
11	GND
12	HDMI_CON_CKN
13	CEC
14	HEAC
15	HDMI_DDC_CLK
16	HDMI_DDC_DATA
17	GND
18	+V5_HDMI
19	HDMI_B_HPD



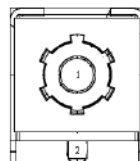


**Table A.29: VGA1**

<b>PIN</b>	<b>PIN_NAME</b>
1	VGA_z_R
2	VGA_z_G
3	VGA_z_B
4	NC
5	GND
6	VGA1_FOC_ON
7	GND
8	GND
9	+V5_VGA
10	GND
11	NC
12	VGA_z_DDAT
13	VGA_z_HS
14	VGA_z_VS
15	VGA_z_DCLK

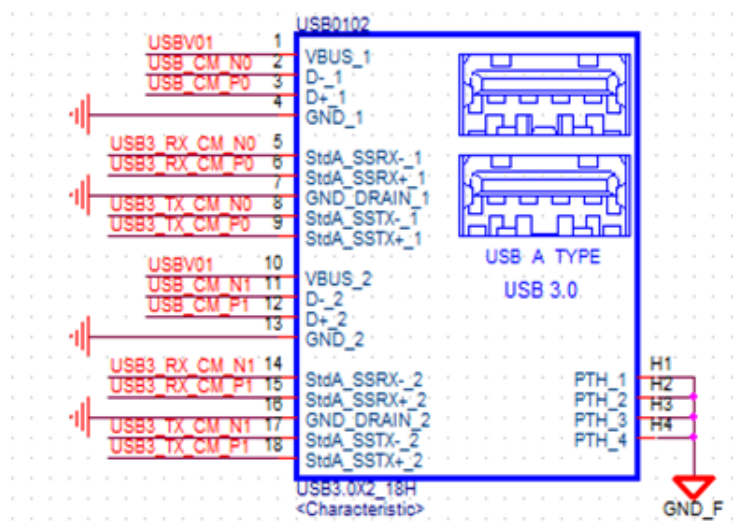
**Table A.30: DCIN1**

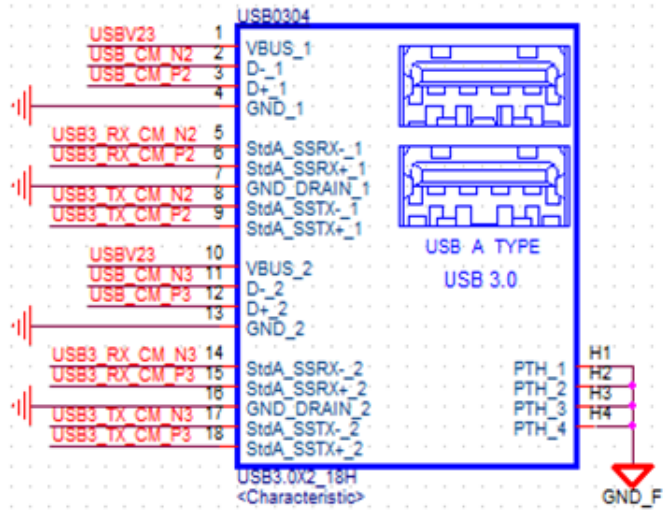
<b>PIN</b>	<b>PIN_NAME</b>
1	+VDCIN_ADP_IN
2	GND



**Table A.31: USB0102/USB0304**

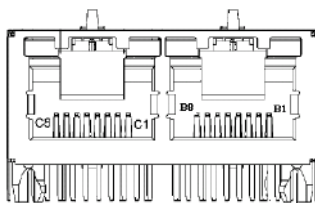
PIN	PIN_NAME
1	+5V
2	D0-
3	D0+
4	GND
5	RX0-
6	RX0+
7	GND
8	TX0-
9	TX0+
10	+5V
11	D1-
12	D1+
13	GND
14	RX1-
15	RX1+
16	GND
17	TX1-
18	TX1+





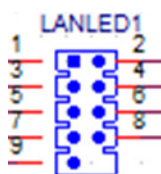
**Table A.32: LAN12**

PIN	PIN_NAME
A1	LAN2_MDI0+
A2	LAN2_MDI0-
A3	LAN2_MDI1+
A4	LAN2_MDI1-
A5	LAN2_CONN
A6	LAN2_CT
A7	LAN2_MDI2+
A8	LAN2_MDI2-
A9	LAN2_MDI3+
A10	LAN2_MDI3-
A11	LAN2_LED1_ACT#
A12	+V3.3A
A13	LAN2_LED2_1G#
A14	LAN2_LED0_100M#
B1	MDI_LAN1_DP0
B2	MDI_LAN1_DN0
B3	MDI_LAN1_DP1
B4	MDI_LAN1_DN1
B5	LAN1_CONN
B6	LAN1_CT
B7	MDI_LAN1_DP2
B8	MDI_LAN1_DN2
B9	MDI_LAN1_DP3
B10	MDI_LAN1_DN3
B11	LAN1_LED0_ACT#
B12	+V3.3A
B13	LAN1_LED1_1G#
B14	LAN1_LED2_100M#



**Table A.33: LANLED1**

PIN	PIN_NAME
1	LAN1_ACTLED-_R
2	LAN2_ACTLED-_R
3	+V3.3A
4	+V3.3A
5	LAN1_LED1000-_R
6	LAN2_LED1000-_R
7	LAN1_LED2_100M#
8	LAN2_LED0_100M#
9	+V3.3A



**Table A.34: SATA1/SATA2**

PIN	PIN_NAME
1	GND
2	TX+
3	TX-
4	GND
5	RX-
6	RX+
7	GND

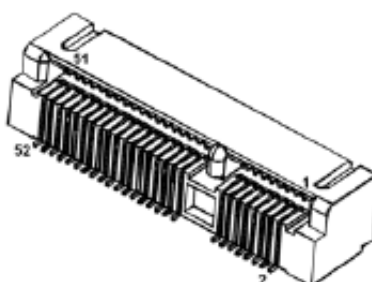


**Table A.35: MINI-PCIE1**

<b>PIN</b>	<b>PIN_NAME</b>
1	PCI_PCIE_WAKE3#
2	+V3.3_PIN43
3	NC
4	GND
5	NC
6	+V1.5
7	CKREQ_a_MINIPCIE1#
8	SIM1_PWR
9	GND
10	SIM1_DATA
11	CLK_PCI_PCIE-
12	SIM1_CLK
13	CLK_PCI_PCIE+
14	SIM1_RESET
15	GND
16	SIM1_VPP
17	NC
18	GND
19	NC
20	MPCIE_F_DIS#
21	MINIPCIE1_DET#
22	PLTRST_MPCIE#
23	MPCIE_MSATA_RX-
24	+V3.3_PIN51
25	MPCIE_MSATA_RX+
26	GND
27	GND
28	+V1.5
29	GND
30	SOC_SMB_CLK
31	MPCIE_MSATA_TX-
32	SOC_SMB_DAT
33	MPCIE_MSATA_TX+
34	GND
35	GND
36	USB_MP_N4_C
37	GND
38	USB_MP_P4_C
39	+V3.3_PIN43
40	GND
41	+V3.3_PIN43
42	NC
43	PCIE1.1#_1.0MSATA_SEL
44	NC
45	NC

**Table A.35: MINI-PCIE1**

46	NC
47	NC
48	+V1.5
49	NC
50	GND
51	MSATA#_b_PCIE_SEL
52	+V3.3_PIN43

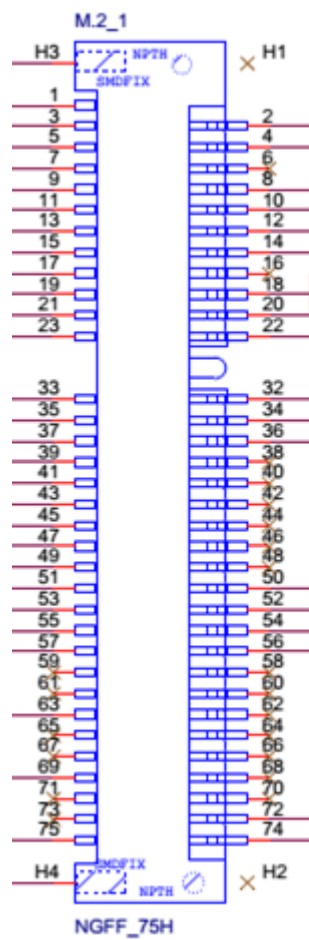
**Table A.36: M.2\_1**

PIN	PIN_NAME
1	GND
2	+V3.3A_M.2
3	USB_HUB0_M2_z_P3
4	+V3.3A_M.2
5	USB_HUB0_M2_z_N3
6	NC
7	GND
8	I2S3_BT_BCLK
9	SDIO_WIFI_CLK
10	I2S3_BT_SYNC
11	SDIO_WIFI_CMD
12	I2S3_BT_SDI
13	SDIO_WIFI_D0
14	I2S3_BT_SDO
15	SDIO_WIFI_D1
16	NC
17	SDIO_WIFI_D2
18	GND
19	SDIO_WIFI_D3
20	LPSS_UART0_BT_WAKE#
21	SDIO_WIFI_WAKE#
22	LPSS_UART0_BT_RXD
23	SDIO_WIFI_RST
32	LPSS_UART0_BT_TXD
33	GND
34	LPSS_UART0_BT_CTS#

**Table A.36: M.2\_1**

35	M2_TX_P_C
36	LPSS_UART0_BT_RTS#
37	M2_TX_N_C
38	NC
39	GND
40	NC
41	M2_RX_P
42	NC
43	M2_RX_N
44	NC
45	GND
46	NC
47	CLK_M2_P
48	NC
49	CLK_M2_N
50	NGFF_PMU_SUSCLK
51	M.2_DET#
52	NGFF_PLTRST#
53	PCIE_REQ2_NGFF#
54	NGFF_BT_DISABLE#
55	PCIE_WAKE#
56	NGFF_WIFI_DISABLE#
57	GND
58	NC
59	NC
60	NC
61	NC
62	NC
63	GND
64	NC
65	NC
66	NC
67	NC
68	NC
69	GND
70	NC
71	NC
72	+V3.3A_M.2
73	NC
74	+V3.3A_M.2
75	GND





**ADVANTECH**

*Enabling an Intelligent Planet*

**[www.advantech.com](http://www.advantech.com)**

Please verify all specifications before quoting. This guide is intended for reference purpOS only.

All product specifications are subject to change without notice.

No part of this publication may be reproduced in any form or by any means, electronic, photocopying, recording or otherwise, without prior written permission from the publisher.

All brand and product names are trademarks or registered trademarks of their respective companies.

© Advantech Co., Ltd. 2017

Our company network supports you worldwide with offices in Germany, Austria, Switzerland, the UK and the USA. For more information please contact:

## Headquarters

### Germany



#### FORTEC Elektronik AG

Augsburger Str. 2b  
82110 Germering

Phone: +49 89 894450-0  
E-Mail: [info@forteca.de](mailto:info@forteca.de)  
Internet: [www.forteca.de](http://www.forteca.de)

## Fortec Group Members

### Austria



#### Distec GmbH Office Vienna

Nuschinggasse 12  
1230 Wien

Phone: +43 1 8673492-0  
E-Mail: [info@distec.de](mailto:info@distec.de)  
Internet: [www.distec.de](http://www.distec.de)

### Germany



#### Distec GmbH

Augsburger Str. 2b  
82110 Germering

Phone: +49 89 894363-0  
E-Mail: [info@distec.de](mailto:info@distec.de)  
Internet: [www.distec.de](http://www.distec.de)

### Switzerland



#### ALTRAC AG

Bahnhofstraße 3  
5436 Würenlos

Phone: +41 44 7446111  
E-Mail: [info@altrac.ch](mailto:info@altrac.ch)  
Internet: [www.altrac.ch](http://www.altrac.ch)

### United Kingdom



#### Display Technology Ltd.

Osprey House, 1 Osprey Court  
Hichingbrooke Business Park  
Huntingdon, Cambridgeshire, PE29 6FN

Phone: +44 1480 411600  
E-Mail: [info@displaytechnology.co.uk](mailto:info@displaytechnology.co.uk)  
Internet: [www.displaytechnology.co.uk](http://www.displaytechnology.co.uk)

### USA



#### Apollo Display Technologies, Corp.

87 Raynor Avenue,  
Unit 1 Ronkonkoma,  
NY 11779

Phone: +1 631 5804360  
E-Mail: [info@apolloDisplays.com](mailto:info@apolloDisplays.com)  
Internet: [www.apolloDisplays.com](http://www.apolloDisplays.com)