



OUR GLOBAL
COMPETENCE
CENTRES

 APOLLO DISPLAY
TECHNOLOGIES



 DISTEC



 DISPLAY
TECHNOLOGY



Manual

ADVANTECH

MIO-2361

2,5" Single-Board Computer with
Intel® Atom™ E3900 Series & Pentium N4200 processor

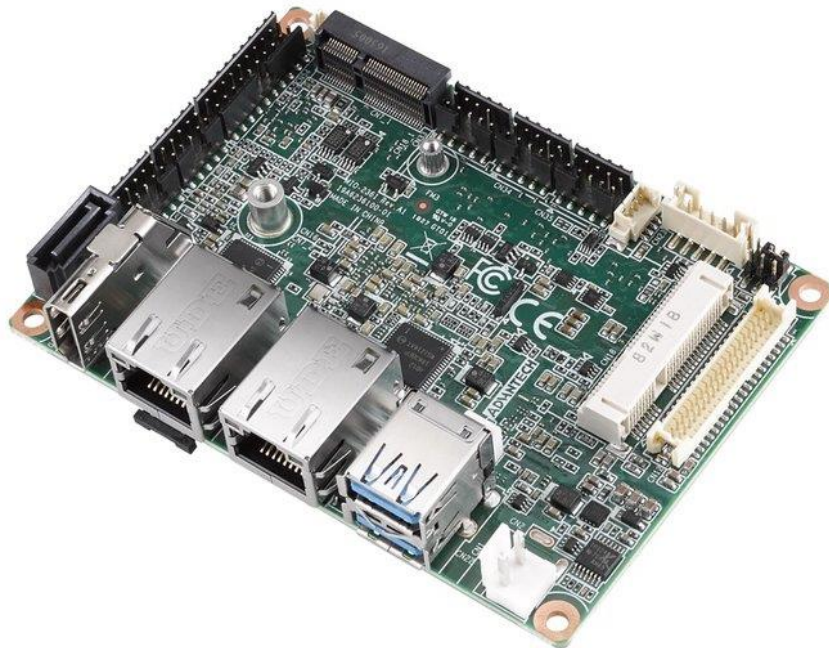

The information contained in this document has been carefully researched and is, to the best of our knowledge, accurate. However, we assume no liability for any product failures or damages, immediate or consequential, resulting from the use of the information provided herein. Our products are not intended for use in systems in which failures of product could result in personal injury. All trademarks mentioned herein are property of their respective owners. All specifications are subject to change without notice.

MIO-2361

**Intel® Atom™ E3900 series/
Pentium N4200/Celeron N3350,
Pico-ITX SBC, Onboard LPDDR4,
eMMC, 48-bit LVDS, HDMI, 2
GbE, USB3.0, 2 COM, M.2 E-key
2230, F/S mSATA,
opt. mPCIe, SMBus**

Copyright

The documentation and the software included with this product are copyrighted 2019 by Advantech Co., Ltd. All rights are reserved. Advantech Co., Ltd. reserves the right to make improvements in the products described in this manual at any time without notice.

No part of this manual may be reproduced, copied, translated or transmitted in any form or by any means without the prior written permission of Advantech Co., Ltd. Information provided in this manual is intended to be accurate and reliable. However, Advantech Co., Ltd. assumes no responsibility for its use, nor for any infringements of the rights of third parties, which may result from its use.

Acknowledgements

AMI is a trademark of AMI Software International, Inc.

Intel® is a trademark of Intel® Technologies, Inc.

IBM, PC/AT, PS/2 and VGA are trademarks of International Business Machines Corporation.

Intel and Atom® are trademarks of Intel Corporation.

Microsoft Windows® is a registered trademark of Microsoft Corp.

RTL is a trademark of Realtek Semi-Conductor Co., Ltd.

ESS is a trademark of ESS Technology, Inc.

UMC is a trademark of United Microelectronics Corporation.

SMI is a trademark of Silicon Motion, Inc.

Creative is a trademark of Creative Technology LTD.

All other product names or trademarks are properties of their respective owners.

Product Warranty (2 years)

Advantech warrants to you, the original purchaser, that each of its products will be free from defects in materials and workmanship for two years from the date of purchase.

This warranty does not apply to any products which have been repaired or altered by persons other than repair personnel authorized by Advantech, or which have been subject to misuse, abuse, accident or improper installation. Advantech assumes no liability under the terms of this warranty as a consequence of such events.

Because of Advantech's high quality-control standards and rigorous testing, most of our customers never need to use our repair service. If an Advantech product is defective, it will be repaired or replaced at no charge during the warranty period. For out-of-warranty repairs, you will be billed according to the cost of replacement materials, service time and freight. Please consult your dealer for more details.

If you think you have a defective product, follow these steps:

1. Collect all the information about the problem encountered. (For example, CPU speed, Advantech products used, other hardware and software used, etc.) Note anything abnormal and list any onscreen messages you get when the problem occurs.
2. Call your dealer and describe the problem. Please have your manual, product, and any helpful information readily available.
3. If your product is diagnosed as defective, obtain an RMA (return merchandise authorization) number from your dealer. This allows us to process your return more quickly.
4. Carefully pack the defective product, a fully-completed Repair and Replacement Order Card and a photocopy proof of purchase date (such as your sales receipt) in a shippable container. A product returned without proof of the purchase date is not eligible for warranty service.
5. Write the RMA number visibly on the outside of the package and ship it prepaid to your dealer.

Technical Support and Assistance

1. Visit the Advantech web site at www.advantech.com/support where you can find the latest information about the product.
2. Contact your distributor, sales representative, or Advantech's customer service center for technical support if you need additional assistance. Please have the following information ready before you call:
 - Product name and serial number
 - Description of your peripheral attachments
 - Description of your software (operating system, version, application software, etc.)
 - A complete description of the problem
 - The exact wording of any error messages

Packing List

Before installation, please ensure the following items have been shipped:

Item Part Number

- 1 MIO-2361 SBC
- 1 Startup manual
- Cables

Part Number	Description
1700006291	SATA cable 7P 30 cm w/ right angle
1701200220	COM PORT cable 2*10P-2.0/D-SUB 9P(M)*2 22 cm
1700027546-01	A cable 1*5P-2.0/1*5P-2.0+SATA 15P 15cm MIO-236
1700002172	USB cable 2.0mm pitch USB-A(F) 17cm
1700019705	AT Power cable 12cm

- Heatsink:

1960087918T001	CPU heatsink for MIO-2361 29mm
----------------	--------------------------------

- Stud & Screw

Part Number	Description
9666226300E	Stud and screw pack, including:
1935031500	Screw R/S D=5.3 H=2 + M3*15L, 4 pcs
1910002596-01	Stud F=M3*10L M=M3*5L B=5 H=19, 4 pcs
193B0204C0	Screw F/S D=3.5 H=0.8 + M2*4L, 2 pcs

Ordering Information

Model Number	Description
MIO-2361EW-S1A1	Intel®APL-E3930, eMMC 32G, -40~+85°C
MIO-2361EW-S6A1	Intel®APL-E3940, eMMC 32G, -40~+85°C
MIO-2361EW-S7A1	Intel®APL-E3950, eMMC 32G, -40~+85°C
MIO-2361N-S1A1	Intel®APL-N4200, eMMC 32G, 60°C

Optional Accessories

Part No.	Description
1960089107N001	MIO-2361 Heat spreader
IDK-1110WP-50XGA1E	10.1" LED PANEL 500N
IDK-1115P-50XGA1E	15" LED PANEL 500N

Declaration of Conformity

This device complies with the requirements in part 15 of the FCC rules: Operation is subject to the following two conditions:

1. This device may not cause harmful interference, and
2. This device must accept any interference received, including interference that may cause undesired operation

FCC Class B

Note: This equipment has been tested and found to comply with the limits for a Class B digital device, pursuant to part 15 of the FCC Rules. These limits are designed to provide reasonable protection against harmful interference in a residential installation. This equipment generates, uses and can radiate radio frequency energy and, if not installed and used in accordance with the instructions, may cause harmful interference to radio communications. However, there is no guarantee that interference will not occur in a particular installation. If this equipment does cause harmful interference to radio or television reception, which can be determined by turning the equipment off and on, the user is encouraged to try to correct the interference by one or more of the following measures:

- Reorient or relocate the receiving antenna.
- Increase the separation between the equipment and receiver.
- Connect the equipment into an outlet on a circuit different from that to which the receiver is connected.
- Consult the dealer or an experienced radio/TV technician for help.

Caution! *There is a danger of a new battery exploding if it is incorrectly installed. Do not attempt to recharge, force open, or heat the battery. Replace the battery only with the same or equivalent type recommended by the manufacturer. Discard used batteries according to the manufacturer's instructions.*



Safety Instructions

1. Read these safety instructions carefully.
2. Keep this User Manual for later reference.
3. Disconnect this equipment from any AC outlet before cleaning. Use a damp cloth. Do not use liquid or spray detergents for cleaning.
4. For plug-in equipment, the power outlet socket must be located near the equipment and must be easily accessible.
5. Keep this equipment away from humidity.
6. Put this equipment on a reliable surface during installation. Dropping it or letting it fall may cause damage.
7. The openings on the enclosure are for air convection. Protect the equipment from overheating. **DO NOT COVER THE OPENINGS.**
8. Make sure the voltage of the power source is correct before connecting the equipment to the power outlet.
9. Position the power cord so that people cannot step on it. Do not place anything over the power cord.
10. All cautions and warnings on the equipment should be noted.
11. If the equipment is not used for a long time, disconnect it from the power source to avoid damage by transient overvoltage.
12. Never pour any liquid into an opening. This may cause fire or electrical shock.
13. Never open the equipment. For safety reasons, the equipment should be opened only by qualified service personnel.
14. If one of the following situations arises, get the equipment checked by service personnel:
 - The power cord or plug is damaged.
 - Liquid has penetrated into the equipment.
 - The equipment has been exposed to moisture.
 - The equipment does not work well, or you cannot get it to work according to the user's manual.
 - The equipment has been dropped and damaged.
 - The equipment has obvious signs of breakage.
15. **DO NOT LEAVE THIS EQUIPMENT IN AN ENVIRONMENT WHERE THE STORAGE TEMPERATURE MAY GO BELOW -20° C (-4° F) OR ABOVE 60° C (140° F). THIS COULD DAMAGE THE EQUIPMENT. THE EQUIPMENT SHOULD BE IN A CONTROLLED ENVIRONMENT.**
16. **CAUTION: DANGER OF EXPLOSION IF BATTERY IS INCORRECTLY REPLACED. REPLACE ONLY WITH THE SAME OR EQUIVALENT TYPE RECOMMENDED BY THE MANUFACTURER, DISCARD USED BATTERIES ACCORDING TO THE MANUFACTURER'S INSTRUCTIONS.**

The sound pressure level at the operator's position according to IEC 704-1:1982 is no more than 70 dB (A).

DISCLAIMER: This set of instructions is given according to IEC 704-1. Advantech disclaims all responsibility for the accuracy of any statements contained herein.

Safety Precaution - Static Electricity

Follow these simple precautions to protect yourself from harm and the products from damage.

- To avoid electrical shock, always disconnect the power from your PC chassis before you work on it. Don't touch any components on the CPU card or other cards while the PC is on.
- Disconnect power before making any configuration changes. The sudden rush of power as you connect a jumper or install a card may damage sensitive electronic components.

Contents

Chapter 1	General Introduction	1
1.1	Introduction	2
1.2	Specifications	2
1.2.1	General Specifications	2
1.2.2	OS Support List.....	3
1.2.3	Functional Specifications	3
1.2.4	Mechanical Specifications.....	4
1.2.5	Electrical Specifications	4
1.2.6	Environmental Specifications.....	5
1.3	Function Block Diagram	6
Chapter 2	H/W Installation.....	7
2.1	Jumpers	8
2.1.1	Jumper Description	8
2.1.2	Jumper List	8
	Table 2.1: Jumper List.....	8
2.1.3	Jumper Settings	8
	Table 2.2: J3: LCD Power	8
2.2	Connectors.....	9
2.2.1	Connector List.....	9
2.2.2	Connector Settings	9
2.3	Mechanical	12
2.3.1	Jumper and Connector Locations	12
	Figure 2.1 MIO-2361 Connector Locations (Bottom Side).....	12
2.3.2	Board Dimensions.....	13
	Figure 2.2 MIO-2361 Mechanical Drawing (Top Side)	13
	Figure 2.3 MIO-2361 Mechanical Drawing (Bottom Side)	13
	Figure 2.4 MIO-2361 Mechanical Drawing (Side View).....	14
	Figure 2.5 MIO-2361 Mechanical Drawing (Side View with Heat-sink).....	14
	Figure 2.6 MIO module height constraints.....	15
Chapter 3	BIOS Settings.....	17
3.1	Entering Setup	19
3.1.1	Main Setup.....	19
3.1.2	Advanced BIOS Features Setup.....	21
3.1.3	Chipset Configuration	30
3.1.4	Security	40
3.1.5	Boot.....	41
3.1.6	Save & Exit	42
Chapter 4	S/W Introduction & Installation	43
4.1	S/W Introduction.....	44
4.2	Driver Installation	44
4.2.1	Windows 10 Professional.....	44
4.2.2	Other OS.....	44
4.3	Value-Added Software Services	44
4.3.1	SUSI Introduction.....	44
4.3.2	Software APIs	45

4.3.3	SUSI Installation	46
4.3.4	SUSI Sample Programs.....	47

Appendix A **PIN Assignments 55**

A.1	Jumper Settings.....	56
A.2	Connectors.....	58
	Table A.1: Connector list	58

Appendix B **WDT & GPIO 73**

B.1	Watchdog Timer Sample Code.....	74
B.2	GPIO Sample Code	75

Appendix C **System Assignments..... 77**

C.1	System I/O Ports.....	78
	Table C.1: System I/O Ports	78
C.2	1st MB Memory Map.....	78
	Table C.2: 1st MB Memory Map	78
C.3	Interrupt Assignments	79
	Table C.3: Interrupt assignments.....	79

Chapter 1

General Introduction

This chapter gives background information on the MIO-2361.

Sections include:

- Introduction
- Product Features
- Specifications

1.1 Introduction

MIO-2361 is related to 2.5" Pico-ITX SBC with Intel® Atom™ E3900 series/ Pentium N4200/Celeron N3350 Processor. MIO-2361 supports Onboard LPDDR4-2400, eMMC up to 64GB (TBC), Dual GbE, USB3.0, 2 x RS-232/422/485, 12/24V input; the board also supports Dual independent display by 48-bit LVDS & HDMI. Besides, MIO-2361 has M.2 E-key, mSATA/mPCIe for expansion. MIO-2361, Advantech Innovative Extension SBC, is equipped with flexible multiple I/O functions to assist integrators in developing optimized solutions.

1.2 Specifications

1.2.1 General Specifications

- **CPU:** Intel® Atom™ E3900 series/ Pentium N4200/Celeron N3350
- **System Chipset** Intel® Celeron/Atom SoC integrated
- **BIOS:** AMI EFI 64 Mbit Flash BIOS
- **System Memory:** LPDDR4-2400MT/s, up to 8 GB
- **Watchdog Timer:** 65536 level, 0~65535 sec
- **Expansion Interface:**
 - 1 x M.2 E-key 2230
 - 1 x Full-size mPCIe/mSATA 1/1*(optional)
- **Battery:** Lithium 3 V / 210 mAH

I/O

- **Internal I/O interface:** 1 x SATA3.0, 2 x USB2.0, 2 x RS-232/422/485, 1 x HD Audio, GPIO, SMBus, I2C*(optional)
- **Rear I/O ports:** 2 x RJ45 Ethernet, 1 x HDMI, 2 x USB 3.0, 1 x Power connector (or DC jack, supported by request)

Ethernet

- **Controller:**
 - LAN1: Intel i210AT/IT
 - LAN2: Intel i210AT/IT (*i210IT is for EW-series)
- **Speed:** 10/100/1000 Mbps
- **Connector:** 2 x RJ45
- **Standard:** Compliant with IEEE 802.3, IEEE 802.3u, IEEE 802.3z, IEEE 802.ab
- Supports wake-on-LAN

Display

- **Controller:** Intel® SoC E3900 series, DirectX*12, and OpenGL4.4 support
- **Resolution:**
 - LVDS: Dual-Channel 48-bit, up to 1920 x 1200
 - HDMI1.4b: up to 3840 x 2160 at 30Hz

1.2.2 OS Support List

OS	
Windows 10 (x64)	Yes (UEFI mode only)
Yocto	Yocto BSP (Support by request)

1.2.3 Functional Specifications

Processor

Processor	<ul style="list-style-type: none"> ■ Intel® Pentium N4200/Celeron N3350 ■ Intel® Atom™ E3950/Intel® Atom™ E3940/Intel® Atom™ E3930 ■ Frequency <ul style="list-style-type: none"> – N4200: 2.50 GHz – N3350: 2.40 GHz – E3950: 2.00 GHz – E3940: 1.80 GHz – E3930: 1.80 GHz ■ Manufacturing Technology: 14 nm ■ L2 cache: 2 MB
Memory	<ul style="list-style-type: none"> ■ Supports LPDDR4-2400MT/s, up to 8 GB ■ Socket: Onboard LPDDR4
Graphic Engine	<ul style="list-style-type: none"> ■ 3D: DX12, OGL4.3, OGL ES3.0, OCL 1.2 ■ HW Decode: HEVC/H.265, H.264, MVC, VP8, VP9, MPEG2, VC-1, WMV9 ■ HW Encode: HEVC/H.265, H.264, MVC, VP8
Display	<ul style="list-style-type: none"> ■ HDMI: up to 3840 x 2160 at 30Hz ■ LVDS: Dual-Channel 48-bit, up to 1920 x 1200 ■ Dual independent display: HDMI+48-bit LVDS

Chipset

Control Hub	<ul style="list-style-type: none"> ■ Intel® Atom SoC integrated
Audio	<ul style="list-style-type: none"> ■ High Definition Audio (HD) ALC-888S codec ■ Up to 2 channel of PCM (Pulse Code Modulation) audio output ■ Connectors: Line-in/Line-out/MIC
PCI-Express Interface	<ul style="list-style-type: none"> ■ 4 PCI-Express x1 Lanes ■ Lane 1: Intel i210 GbE controller ■ Lane 2: Intel i210 GbE controller ■ Lane 3: M.2 E-key 2230 ■ Lane 4: Full-size mPCIe/mSATA connector
SATA Interface	<ul style="list-style-type: none"> ■ 1 x mSATA by mini-PCIe socket ■ 1 x SATAIII (Max. Data transfer Rate 600 MB/s)
USB Interface	<ul style="list-style-type: none"> ■ 2 x internal USB ports ■ 2 x rear I/O ports at coastline, 2 x USB3.0 ■ Transmission speed up to 480 Mbps (USB 2.0) / 5 Gbps (USB 3.0)
Power Management	<ul style="list-style-type: none"> ■ Full ACPI (Advanced Configuration and Power Interface) 3.0 ■ Supports S0, S3, S4, S5 ■ Support Wake on LAN

BIOS	AMI EFI 64 Mbit Flash BIOS via SPI
Storage	
eMMC	32GB (default). 64GB* (optional, TBC) Note#1: verified with 1410028472-01/SQF-MM5M2-32G-M5E
Expansion	
M.2	E-Key 2230 (PCIe x1, USB2.0)
mPCIe/mSATA	1/1*(optional)
Others	
Ethernet	<ul style="list-style-type: none"> ■ Controller: Intel® i210IT/i210AT ■ Compliant with IEEE 802.3, IEEE 802.3u, IEEE 802.3z, IEEE 802.ab ■ Supports 10/100/1000 Mbps ■ Connectors: 2 x RJ45 ■ LAN LED <ul style="list-style-type: none"> – Link: Green (100Mbps)/ Orange (1000Mbps) – Active: Green (flash) ■ Supports wake on LAN
Serial ports	<ul style="list-style-type: none"> ■ Controller: EC IS200 ■ 2 x 232/422/485 serial ports with ESD protection: air gap ± 15 kV, contact ± 8 kV
GPIO	<ul style="list-style-type: none"> ■ Controller: EC IS200 ■ 16-bit (programming) through Super I/O, pin header ■ 5 V tolerance
SMBus	Default is SMBus
I2C	By optional request

1.2.4 Mechanical Specifications

1.2.4.1 Dimensions (mm)

L100 mm x W72 mm (3.9" x 2.8")

1.2.4.2 Height on top (mm)

30.61 mm (included Heatsink)

1.2.4.3 Height under bottom (mm)

16.52 mm (Rear I/O USB, HDMI)

1.2.5 Electrical Specifications

Power Supply Type: Single 12 V DC power input (support DC power hot plug)

1.2.5.1 Power supply Voltage

12V or 24V +/- 10%

1.2.5.2 Power Consumption

- **Typical in Windows 10 Idle Mode:**
E3950: 8.59 W (12V)
E3950: 8.81 W (24V)
- **Max in Windows 10 HCT12 (10 minutes):**
E3950: 26.27 W (12V)
E3950: 26.51 W (24V)

1.2.5.3 RTC Battery

- **Typical Voltage:** 3.0 V
- **Normal discharge capacity:** 210 mAh

1.2.6 Environmental Specifications

1.2.6.1 Operating Humidity

40 °C @ 95% RH Non-Condensing

1.2.6.2 Operating Temperature

Standard: 0 ~ 60 °C (32 ~ 140 °F)

Extend: -40 ~ 85 °C (-40 ~ 185 °F)

1.2.6.3 Storage Humidity

Storage: -40 ~ 85 °C (-40 ~ 185 °F)

Storage: 60 °C @ 95%relative humidity, non-condensing

1.2.6.4 Storage Temperature

-40 ~ 85 °C (-40 ~ 185 °F)

1.2.6.5 Thermal Management

1. Maximum operating temperature on any components are tested with the heat-sink.
2. Temperature Specifications condition:
 - Industrial Grade: 85°C, CPU @50% loaded, the key parts are allowed to start throttling for thermal protection.
 - Commercial Grade: 60°C, CPU @100% loaded, the board needs to run at nominal frequency.

1.3 Function Block Diagram

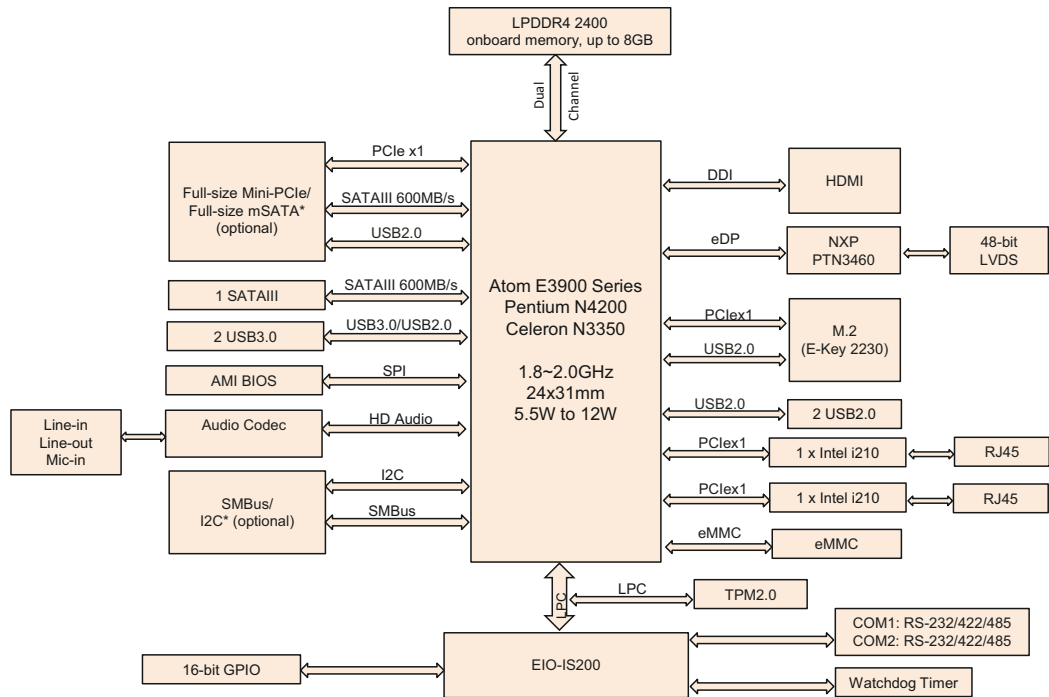

Chapter 2

H/W Installation

This chapter explains the setup procedures of the MIO-2361 hardware, including instructions on setting jumpers and connecting peripherals, as well as switches, indicators and mechanical drawings. Be sure to read all safety precautions before you begin the installation procedure.

2.1 Jumpers

2.1.1 Jumper Description

Cards can be configured by setting jumpers. To close a jumper, you connect the pins with the clip. To open a jumper, you remove the clip. Sometimes a jumper will have three pins, labeled 1, 2 and 3. In this case you would connect either pins 1 and 2, or 2 and 3.

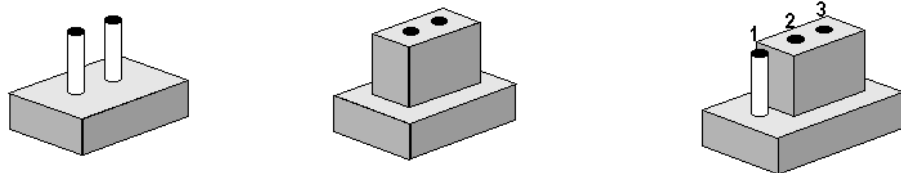

The jumper settings are schematically depicted in this manual as follows.



A pair of needle-nose pliers may be helpful when working with jumpers. If you have any doubts about the best hardware configuration for your application, contact your local distributor or sales representative before you make any changes. Generally, you simply need a standard cable to make most connections.

Warning! To avoid damaging the computer, always turn off the power supply before setting jumpers.



2.1.2 Jumper List

Table 2.1: Jumper List

J3	LCD Power
SW1	Auto Power On/LVDS VCON
SW1 & SW2	12V
SW1 & SW2:	24V

2.1.3 Jumper Settings

Table 2.2: J3: LCD Power

Setting	Function
(1-3)*	+3.3V
(3-5)	+5V
(3-4)	+12V

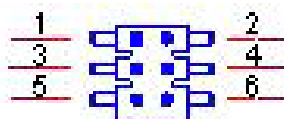

2.2 Connectors

2.2.1 Connector List

CN1	12 V Power Input
CN2	DC JACK
CN4	Battery
CN9	LAN
CN10	LAN
CN12	48-bit LVDS Panel
CN13	HDMI
CN15	SATA
CN16	Audio
CN18	Mini PCIE
CN22	External USB3.0
CN23	SMBus
CN33	Internal USB
CN34	GPIO
CN35	GPIO
CN45	Front panel
CN54	COM1/COM2
CN57	Inverter Power Output

2.2.2 Connector Settings

2.2.2.1 Battery Connector (CN4)

MIO-2361 supports Lithium 3 V/210 mA CR2032 battery with wire.

Note! *How to clear CMOS: (follow below steps)*



1. Turn off system power
2. Unplug CR2032 battery cable on CN4
3. Waiting for 15 sec or short CN4 pin 1-2
4. Connect battery cable on CN4
5. Turn on system power

2.2.2.2 12 V Power Input Connector (CN1)

Main power connector supports single 12 V input, and there's an optional choice of **DC/Jack (CN2, co-layout with 2pin power connector)**

2.2.2.3 GPIO (General Purpose Input Output) (CN34 & CN35)

The board supports 16-bit GPIO (5 V tolerance) through GPIO pin header. The 16 digital inputs and outputs can be programmed to read or control devices, with each input or output defined.

2.2.2.4 HDMI/ LVDS Interface Connections (CN13/CN12)

MIO-2361 has a dual display interface which supports HDMI displays (included passive LCD and active LCD displays).

HDMI display connector (CN13)

Supports HDMI1.4b. Resolution: up to 3840 x 2160 at 30Hz.

LVDS LCD panel connector (CN12)

MIO-2361 supports dual channel 48-bit LVDS LCD panel displays. Resolution: up to 1920 x 1200.

2.2.2.5 Front Panel Connector(CN45)

MIO-2361 integrates below functions as front panel 9-pin connector.

Power button

Supports power on/off button in ATX mode.

Reset

If you install a reset switch, it should be an open single pole switch. Momentarily pressing the switch will activate a reset.

Power LED

Power LED indicator light lit when power is on.

HDD LED

HDD LED indicator for hard disk access is for an active low signal.

2.2.2.6 SATA Connector (CN15)

MIO-2361 supports one high performance Serial ATA interfaces. Data transfer rates up to 600 MB/s enabling very fast data and file transfer, and independent DMA operation on two ports.

2.2.2.7 Mini PCIe Connector (CN18)

MIO-2361 supports a full size mini PCIe slot. PCI Express Mini Card (also known as Mini PCI Express, Mini PCIe, and Mini PCI-E) is a replacement for the Mini PCI form factor based on PCI Express. It is developed by the PCI-SIG. The host device supports both PCI Express and USB 2.0 connectivity. The mini PCIe slot also integrates SATAIII signals, supports mSATA interface modules. (*mSATA is by optional request)

2.2.2.8 USB Connectors (CN22 and CN33)

MIO-2361 provides 4 x USB (Universal Serial Bus) ports, two are external I/O ports (CN22); the other two are internal USB ports (CN33). The rear I/O USB port supports two USB 3.0 ports. The USB 3.0 ports comply with USB specification Rev. 3.0 which supports 5.0 Gbps transfer rate and backward compatible with USB 2.0 device. This gives complete Plug and Play, and hot attach/detach for up to 127 external devices. Other USB interfaces comply with USB specification Rev. 2.0 which supports 480 Mbps transfer rate and are fuse protected.

2.2.2.9 COM Port Connectors (CN54)

MIO-2361 provides two serial ports in 10 x 2pin pin header. COM1/COM2 is for RS232/422/485 functionality. It provides connections for serial devices or a communication network. The pin assignments for the COM port connector can be found in Appendix.

2.2.2.10 Ethernet Connector (CN9/CN10)

MIO-2361 uses Intel® i210IT/i210AT Ethernet chip (10/100/1000 Mbps) linked to dedicated PCIe x1 lane via RJ-45 connector.

2.2.2.11 High Definition Audio Interface (CN16)

MIO-2361 provides one 5 x 2 pin box header for audio device. It can support high definition audio stereo via customized audio module that has a codec onboard.

2.2.2.12 Inverter Power/Internal SATA Power Connector (CN57)

The LCD inverter is connected to CN57 via a 5-pin connector to provide +5 V/+12 V power to the LCD display, and 5V power can be provided for 2.5" SATA HDD via CN57. SATA power's current is only sufficient for 2.5" HDD, and LVDS inverter's current is 5 V @ less than 1 A, 12 V @ 500 mA.

2.2.2.13 SMBus Connector (CN23)

MIO-2361 provides SMBus connector for customer connection to SMBus protocol embedded device. Advantech also provide SMBus API allowing developers to interface with an embedded system environment and transfer serial messages using the SMBus protocols, allowing multiple simultaneous device control.

2.3 Mechanical

2.3.1 Jumper and Connector Locations

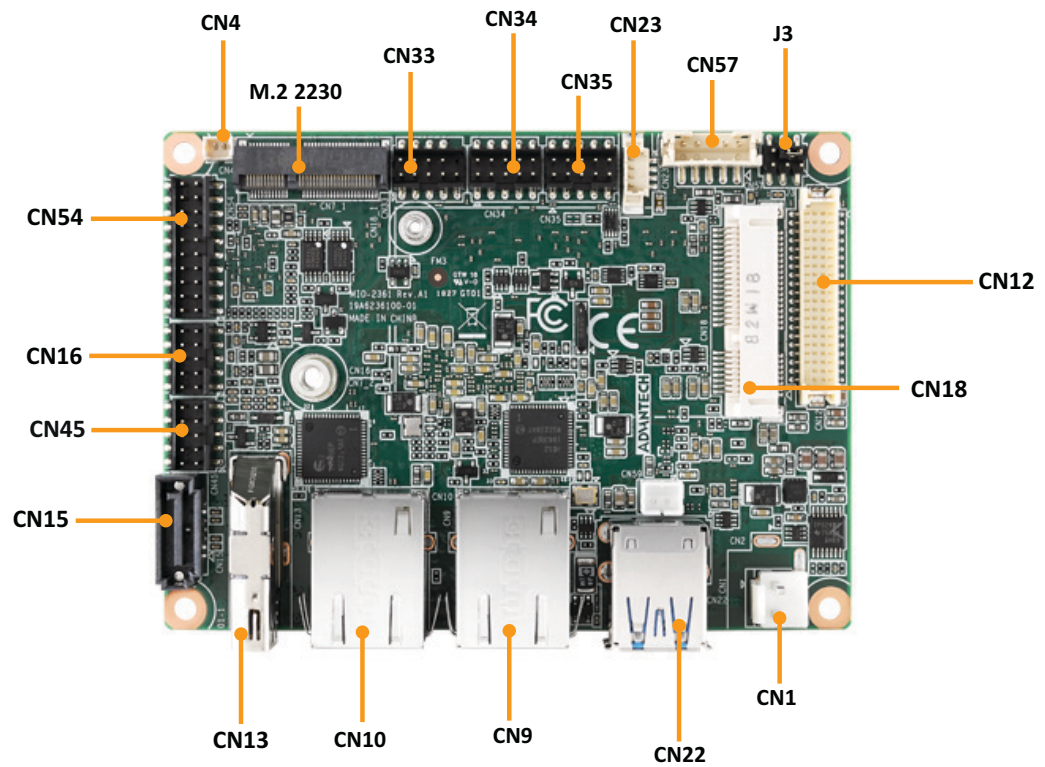

Figure 2.1 MIO-2361 Connector Locations (Bottom Side)

2.3.2 Board Dimensions

2.3.2.1 CPU Board Drawing

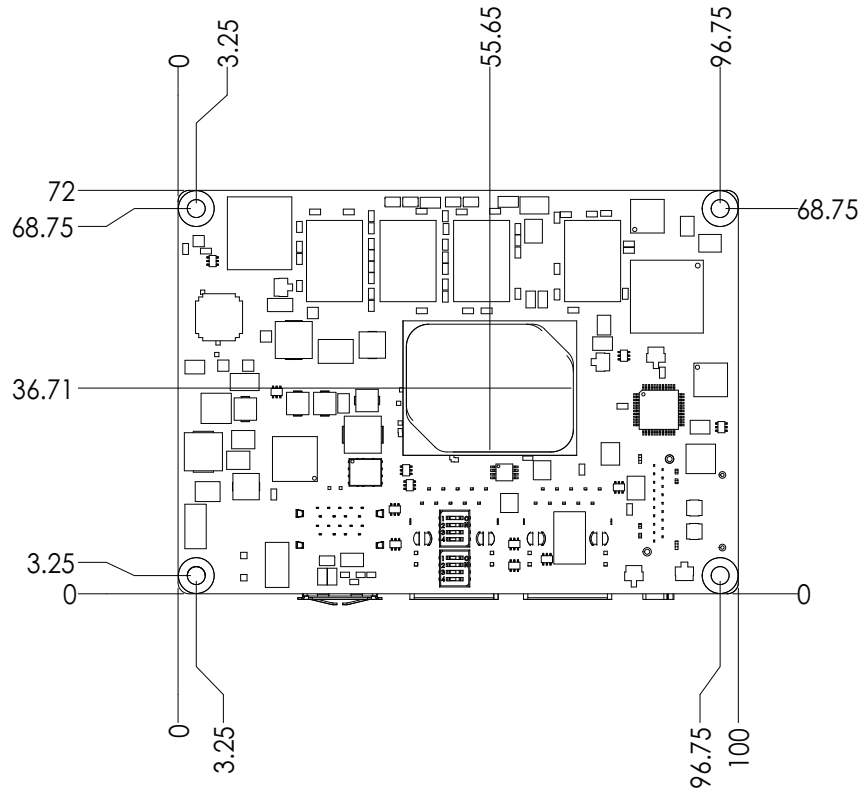

Figure 2.2 MIO-2361 Mechanical Drawing (Top Side)

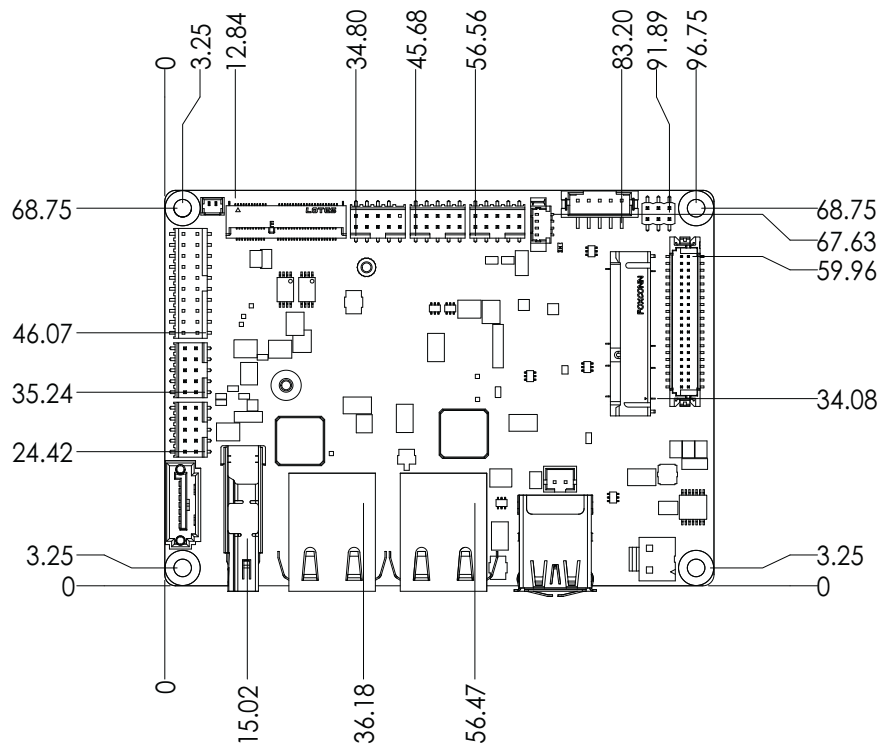

Figure 2.3 MIO-2361 Mechanical Drawing (Bottom Side)

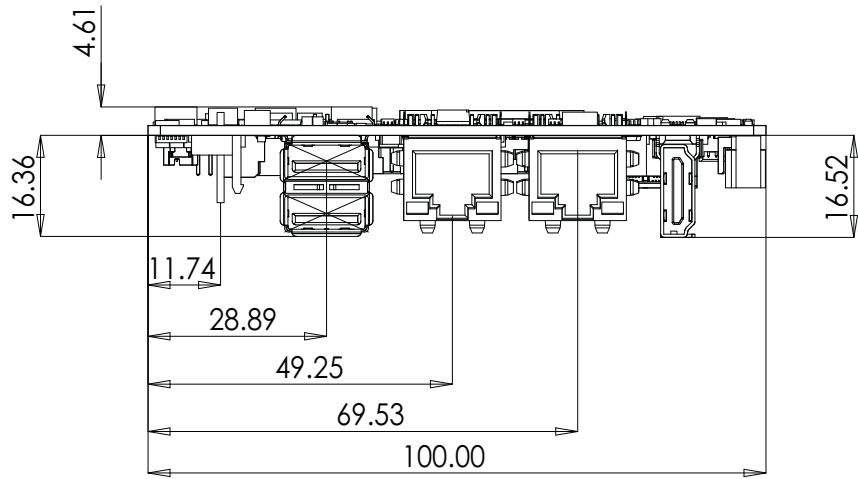

Figure 2.4 MIO-2361 Mechanical Drawing (Side View)

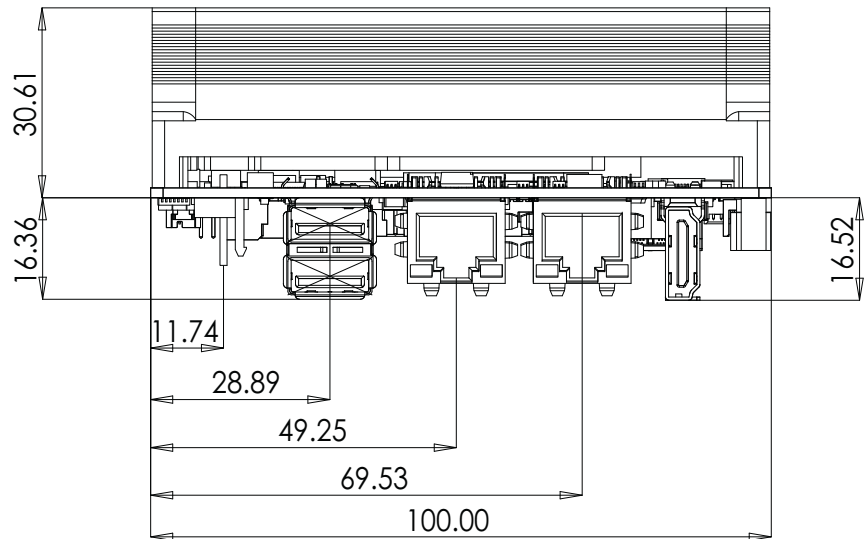

Figure 2.5 MIO-2361 Mechanical Drawing (Side View with Heatsink)

2.3.2.2 MI/O Module Height Constraint

To avoid mechanical conflict with MI/O-Ultra CPU board, it's recommended to refer to the following drawing for MI/O module height constraints.

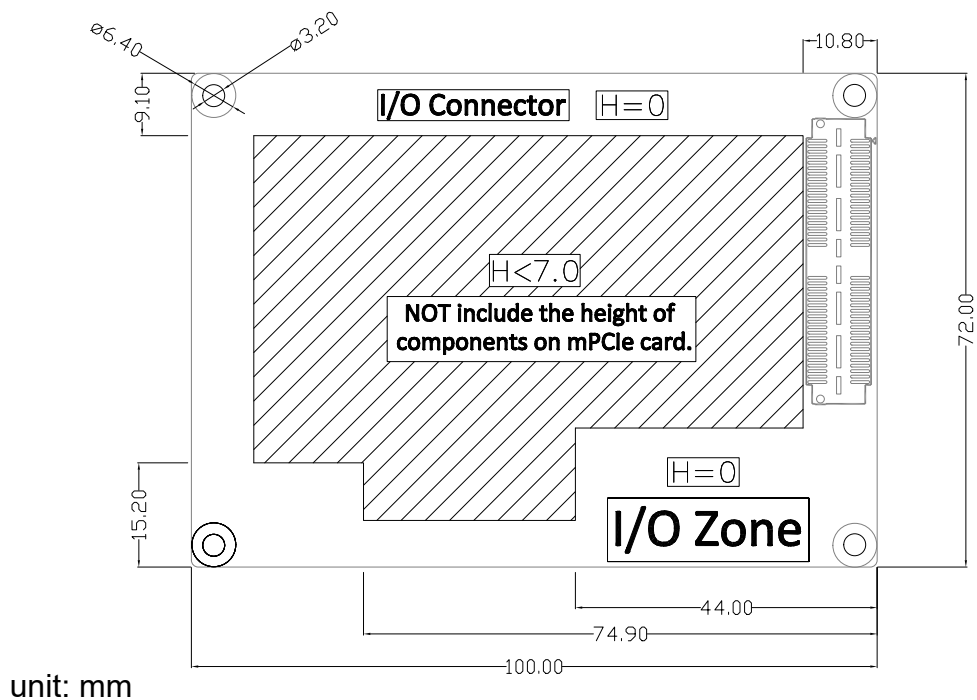

Figure 2.6 MI/O module height constraints

- Note!**
1. Height of MI/O module is based on 16 mm height MIOe connector. If needed, there's a 19 mm height connector as well.
 2. The height of the power connector (including cable) on MIO-2361 should be considered when assembling the system or stacking the MI/O module.



2.3.2.3 Another Thermal Solution - Heat Spreader

MIO-2361 has an optional heat spreader to make whole system more compact. Using a heat spreader to conduct heat from your chassis can help a lot when the system is extra compact or has limited space for heat convection. Here are some guidelines for the heat spreader:

1. For best heat conduction, the gap between the chassis and heat spreader should be smaller, the smaller the better.
2. The height of the existing heat spreader is TBD (Advantech P/N: TBD). If you need some other height to fit the chassis better, Advantech can customize it for you. (Please contact our sales for details).
3. Thermal grease and screws are provided in the heat spreader kit, thermal grease helps conduct better if the chassis is quite close to heat spreader. Another suggestion is to use a thermal pad if the chassis isn't close enough to the heat spreader. (The gap should be less than 3mm for better heat conduction).

Chapter 3

BIOS Settings

With the AMIBIOS Setup program, you can modify BIOS settings and control the various system features. This chapter describes the basic navigation of the MIO-2361 BIOS setup screens.

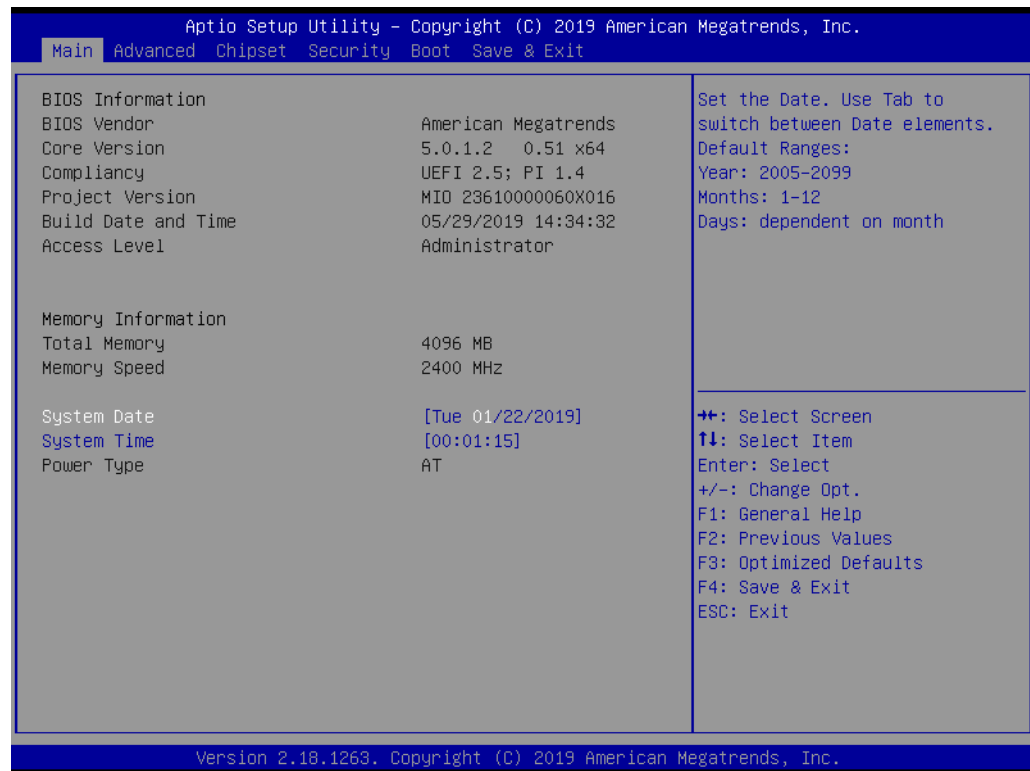

AMI BIOS ROM has a built-in Setup program that allows users to modify the basic system configuration. This information is stored in battery-backed CMOS so it retains the Setup information when the power is turned off.

3.1 Entering Setup

Turn on the computer and check for the patch code. If there is a number assigned to the patch code, it means that the BIOS supports your CPU. If there is no number assigned to the patch code, please contact an Advantech application engineer to obtain an up-to-date patch code file. This will ensure that your CPU's system status is valid. After ensuring that you have a number assigned to the patch code, press and you will immediately be allowed to enter Setup.

3.1.1 Main Setup

When you first enter the BIOS Setup Utility, you will encounter the Main setup screen. You can always return to the Main setup screen by selecting the Main tab. There are two Main Setup options. They are described in this section. The Main BIOS Setup screen is shown below.



The Main BIOS setup screen has two main frames. The left frame displays all the options that can be configured. Grayed-out options cannot be configured; options in blue can. The right frame displays the key legend.

Above the key legend is an area reserved for a text message. When an option is selected in the left frame, it is highlighted in white. Often a text message will accompany it.

- **System time / System date**

Use this option to change the system time and date. Highlight System Time or System Date using the <Arrow> keys. Enter new values through the keyboard.

Press the <Tab> key or the <Arrow> keys to move between fields. The date must be entered in MM/DD/YY format. The time must be entered in HH:MM:SS format.

3.1.2 Advanced BIOS Features Setup

Select the Advanced tab from the MIO-2361 setup screen to enter the Advanced BIOS Setup screen. You can select any of the items in the left frame of the screen, such as CPU Configuration, to go to the sub menu for that item. You can display an Advanced BIOS Setup option by highlighting it using the <Arrow> keys. All Advanced BIOS Setup options are described in this section. The Advanced BIOS Setup screens is shown below. The sub menus are described on the following pages.

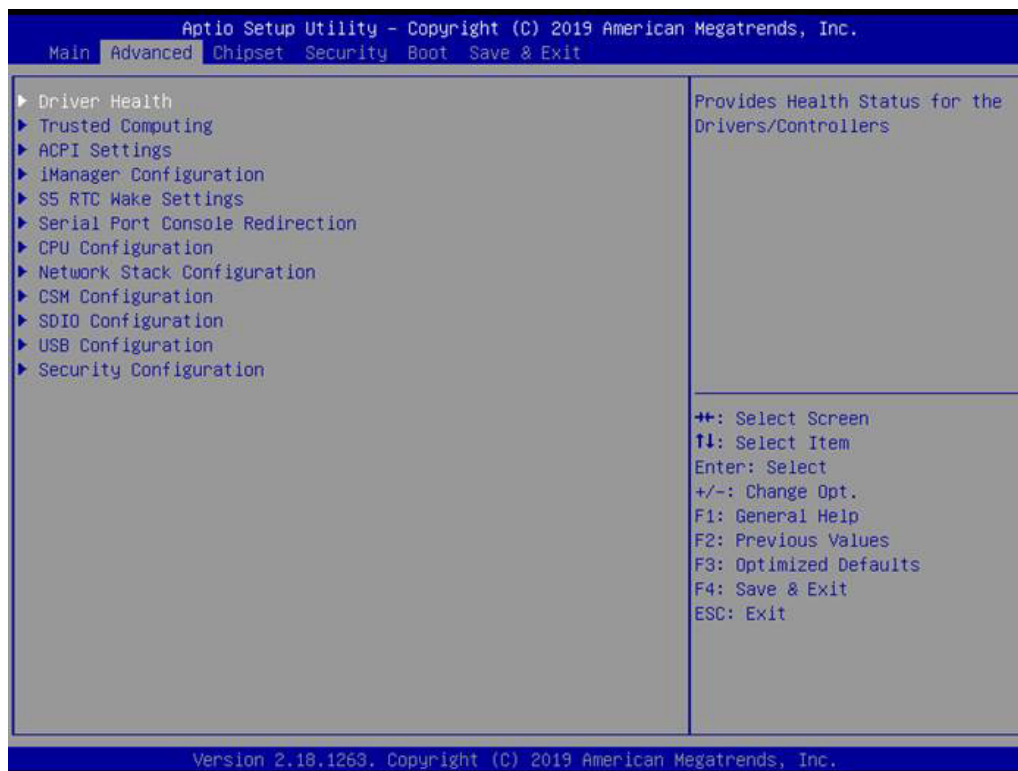

3.1.2.1 Driver Health



Provide Health Status for the Drivers/Controllers.

3.1.2.2 Trusted Computing



- **Security Device Support**
Enable or disable BIOS support for security device.
- **SHA-1 PCR Bank**
Enable or disable SHA-1 PCR Bank.

- **SHA256 PCR Bank**
Enable or disable SHA256 PCR Bank.
- **Pending operation**
Schedule an Operation for the Security Device.
- **Platform Hierarchy**
Enable or disable Platform Hierarchy.
- **Storage Hierarchy**
Enable or disable Storage Hierarchy.
- **Endorsement Hierarchy**
Enable or disable Endorsement Hierarchy.
- **TPM 2.0 UEFI Spec Version**
Select the TCG2 Spec Version Support.
- **Physical Presence Spec Version**
Select to Tell O.S. to support PPI Spec Version 1.2 or 1.3.
- **Device Select**
TPM 1.2 will restrict support to TPM 1.2 devices, TPM 2.0 will restrict support to TPM 2.0 devices.

3.1.2.3 ACPI Settings



- **Enable ACPI Auto Configuration**
Enable or disable BIOS ACPI auto configuration.
- **Enable Hibernation**
Enables or disables the systems ability to hibernate (OS/S4 Sleep State). This option may be not effective with some OS.
- **ACPI Sleep State**
Select the highest ACPI sleep state the system will enter when the SUSPEND button is pressed.

- **Lock Legacy Resources**
Enable or disable Lock of Legacy Resources

3.1.2.4 iManager Configuration

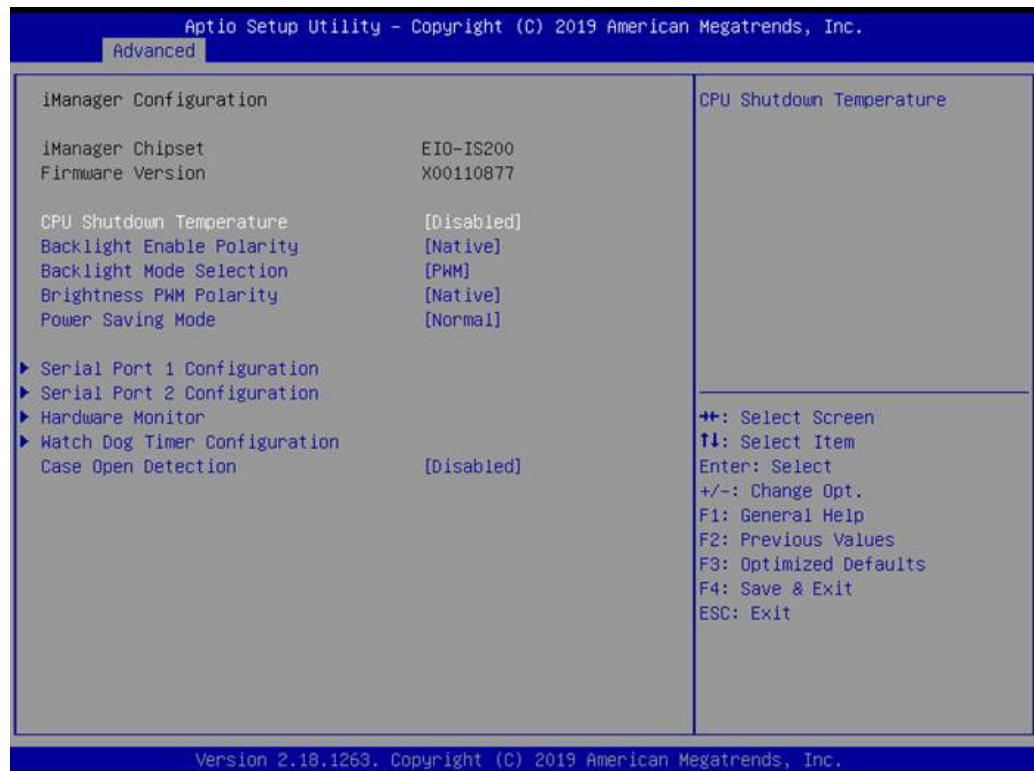

- **CPU Shutdown Temperature**
CPU Shutdown Temperature settings.
- **Backlight Enable Polarity**
Switch Backlight Enable Polarity for Native or Invert.
- **Backlight Mode Selection**
Switch Backlight Control to PWM or DC mode.
- **Brightness PWM Polarity**
Switch backlight control Brightness PWM Polarity to Native or Invert.
- **Power Saving Mode**
This item allows users to set the board's power saving mode when off.
- **Serial Port 1 Configuration**
Set parameters of Serial Port 1 (COMA).
- **Serial Port 2 Configuration**
Set parameters of Serial Port 2 (COMB).
- **Hardware Monitor**
Monitor hardware status.
- **Watch Dog Timer Configuration**
Watch Dog Timer Configuration page.
- **Case Open Detection**
Enable or disable Case Open Detection function.

3.1.2.5 S5 RTC Wake Settings



- Wake system from S5**
 Enable or disable system wake on alarm event. Selecting FixedTime, system will wake on hr:min:sec as specified.

3.1.2.6 Serial Port Console Redirection

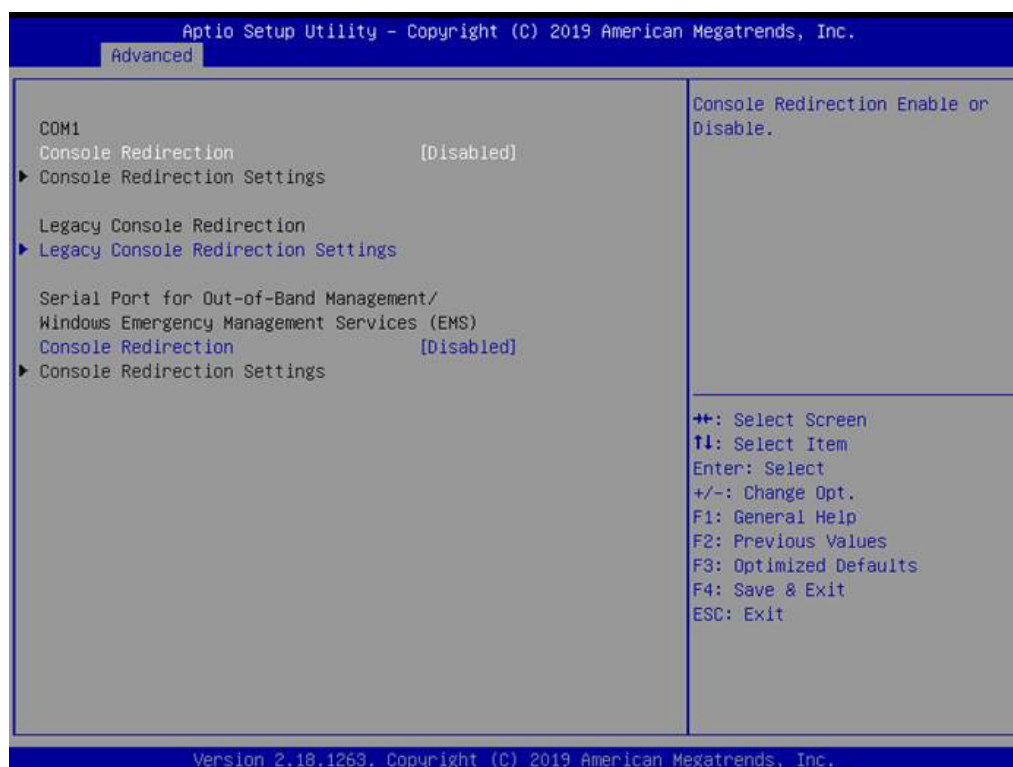

- **Console Redirection**
This item allows users to enable or disable console redirection for Microsoft Windows Emergency Management Services (EMS).
- **Console Redirection**
This item allows users to configure console redirection detail settings.

3.1.2.7 CPU Configuration

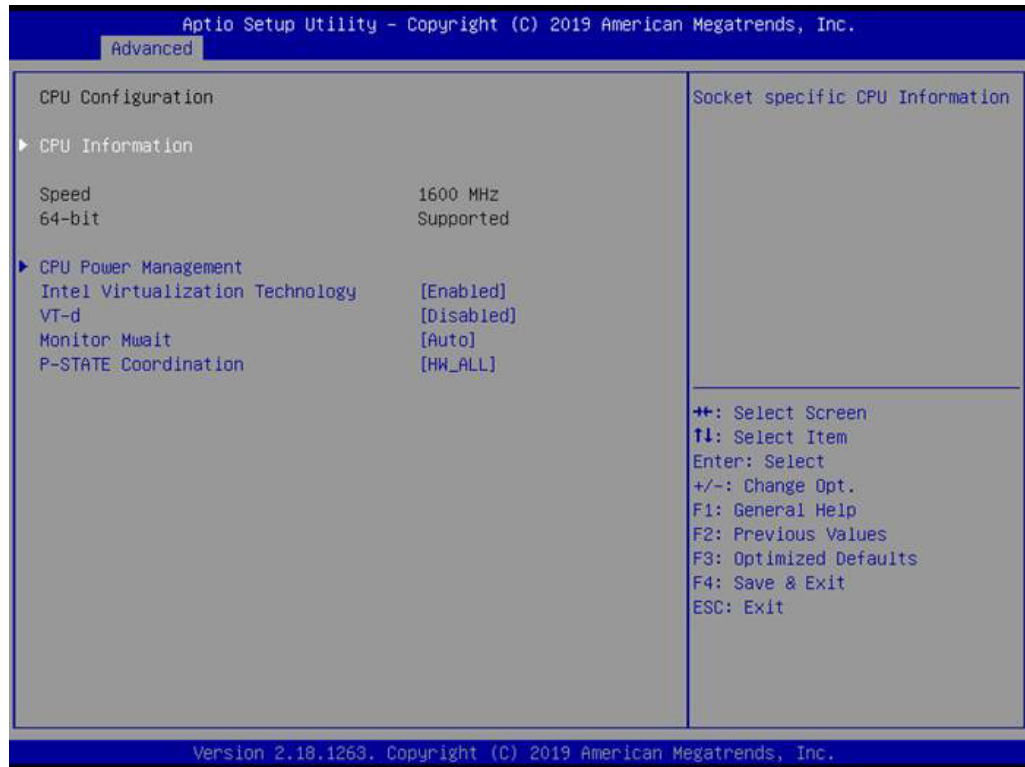

- **Intel Virtualization Technology**
When enabled, a VMM can utilize additional hardware capabilities provided by Vanderpool Technology.
- **VT-d**
Enable/Disable CPU VT-d.
- **Monitor Mwait**
Enable/Disable Monitor Mwait.
- **P-STATE Coordination**
Change P-STATE Coordination type.

3.1.2.8 Network Stack Configuration

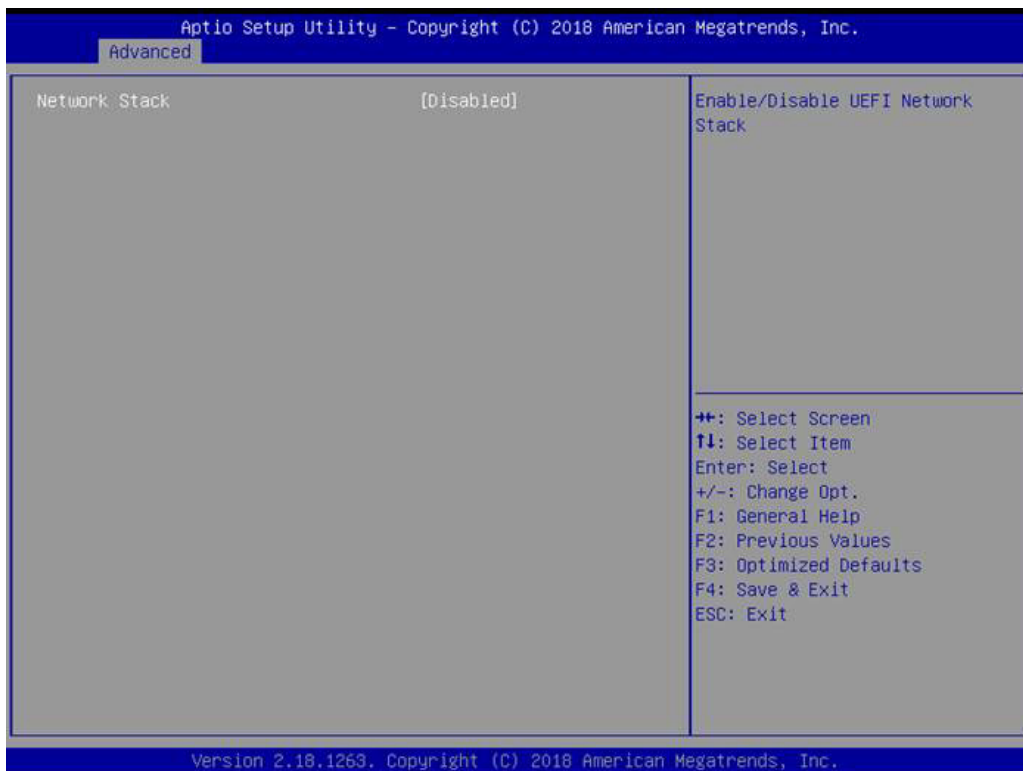

- **Network Stack**
Enable/Disable UEFI Network Stack.

3.1.2.9 CSM Configuration

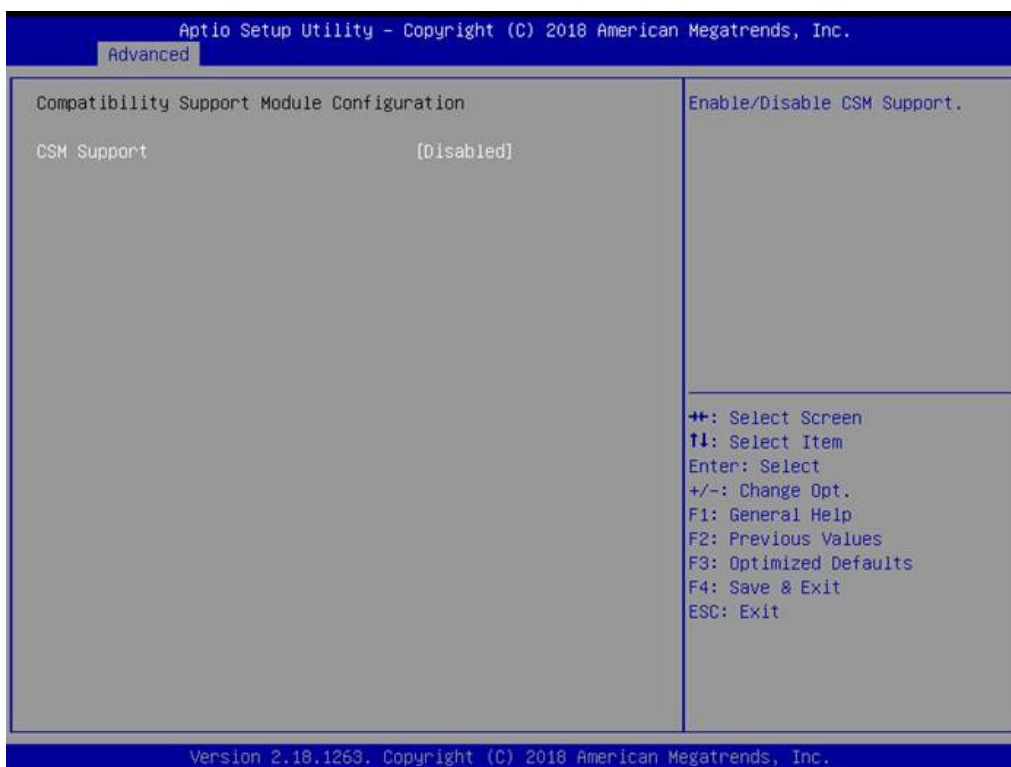

- **CSM Support**
Enable/Disable CSM Support
(*CSM Support for debug purpose)

- **Gate A20 Active**
This item is useful when RT code is executed above 1MB. When this is set as "Upon Request" GA20 can be disabled using BIOS services. When it's set as "Always", it does not allow disabling GA20.
- **INT19 Trap Response**
BIOS reaction on INT19 trapping by Option ROM: IMMEDIATE - execute the trap right away; POSTPONED - execute the trap during legacy boot.
- **Boot option filter**
This option controls Legacy/UEFI ROMs priority.
- **Network**
Controls the execution of UEFI and Legacy PXE OpROM.
- **Storage**
Controls the execution of UEFI and Legacy Storage OpROM.
- **Video**
Controls the execution of UEFI and Legacy Video OpROM.
- **Other PCI devices**
Determines OpROM execution policy for devices other than Network, Storage, or Video.

3.1.2.10 SDIO Configuration

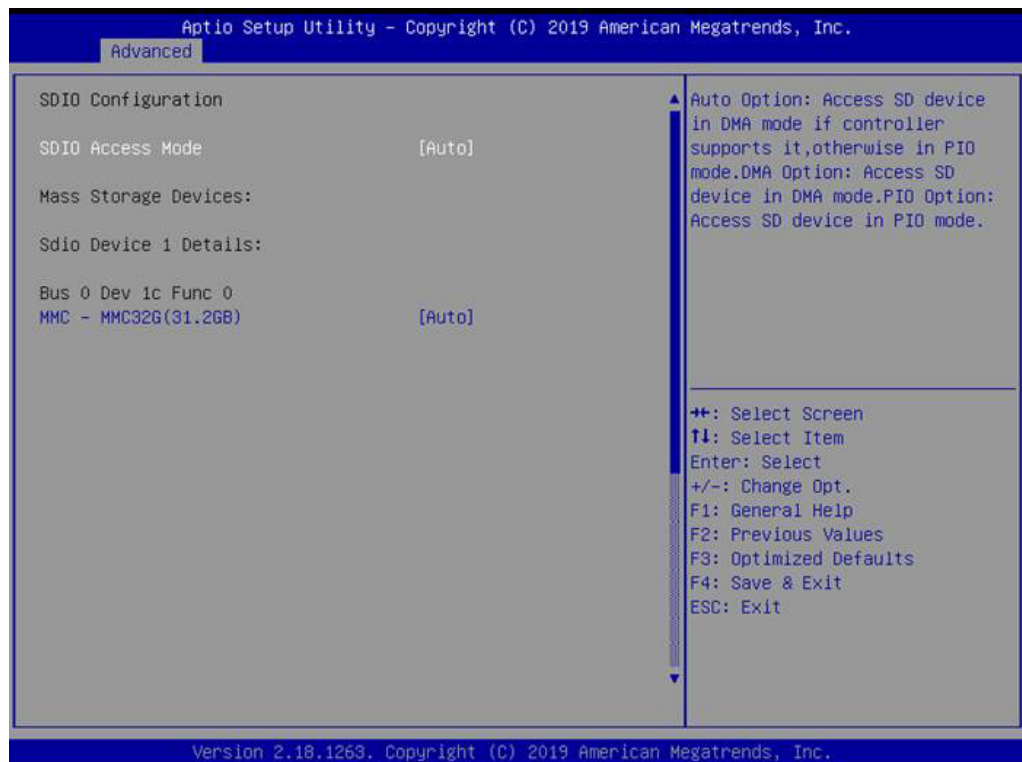

- **SDIO Access Mode**
Select SDIO device operating mode to DMA or PIO mode.

3.1.2.11 USB Configuration



- **Legacy USB Support**
Enables Legacy USB support. AUTO option disables legacy support if no USB devices are connected. DISABLE option will keep USB devices available only for EFI applications.
- **XHCI Hand-off**
This is a workaround for OS without XHCI hand-off support. The XHCI ownership change should be claimed by XHCI driver.
- **USB Mass Storage Driver Support**
Enable/Disable USB Mass Storage Driver Support.
- **USB transfer time-out**
Time-out value for control, bulk, and interrupt transfers.
- **Device reset time-out**
USB mass storage device start unit command time-out.
- **Device power-up delay**
Maximum time the device will take before it properly reports itself to the Host Controller. 'Auto' uses default value: for a Root port it is 100 ms, for a Hub port the delay is taken from Hub descriptor.

3.1.2.12 Security Configuration



- **TXE HMRFP0 Disable**
- **TXE EOP Message**
Sends EOP Message Before Entering OS

3.1.3 Chipset Configuration

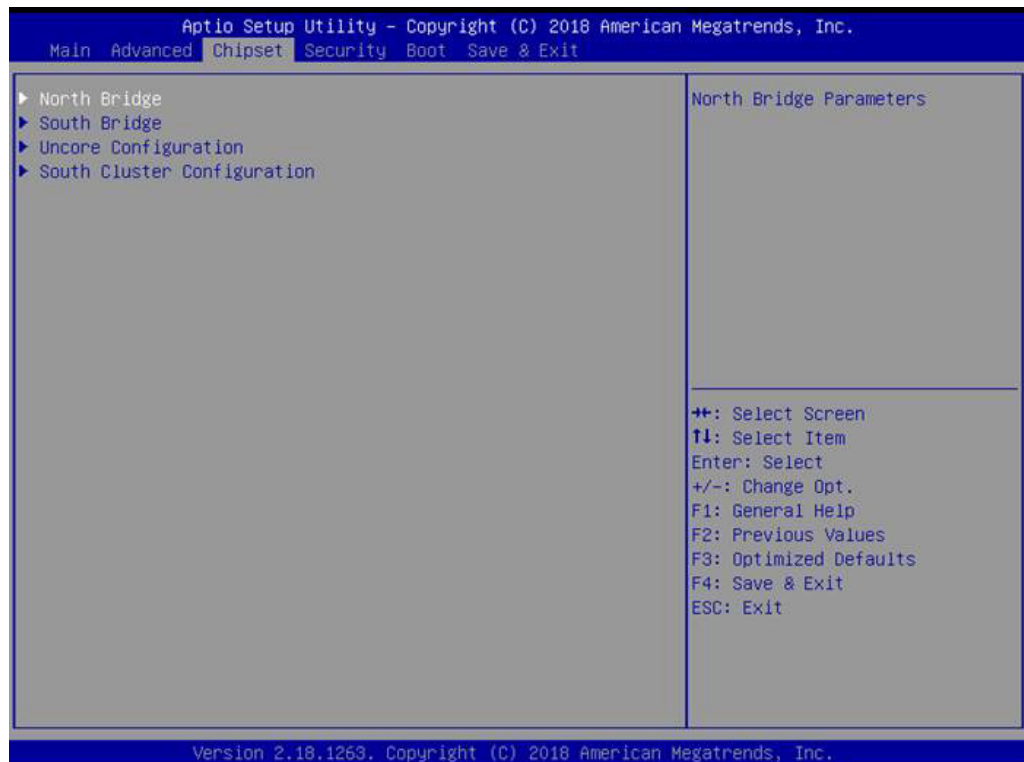

- **North Bridge**
Details for North Bridge items.
- **South Bridge**
Details for South Bridge items.
- **Uncore Configuration**
Details for Uncore Configuration.
- **South Cluster Configuration**
Details for South Cluster Configuration.

3.1.3.1 North Bridge

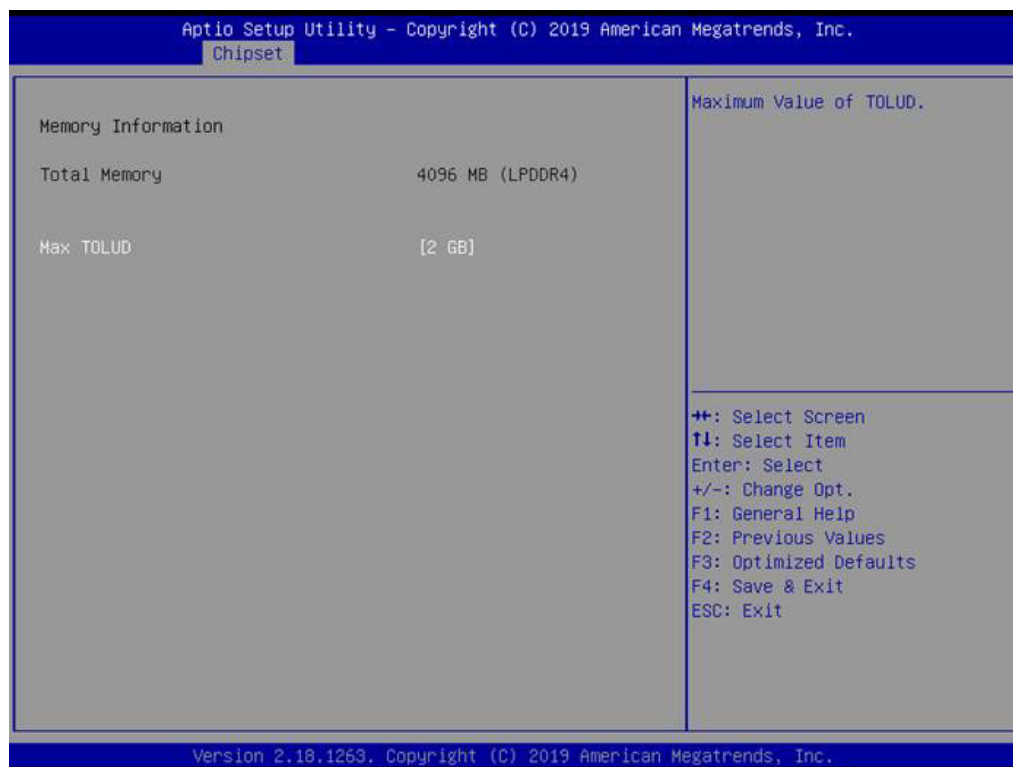

- **Max TOLUD**
Maximum Value of TOLUD.

3.1.3.2 South Bridge

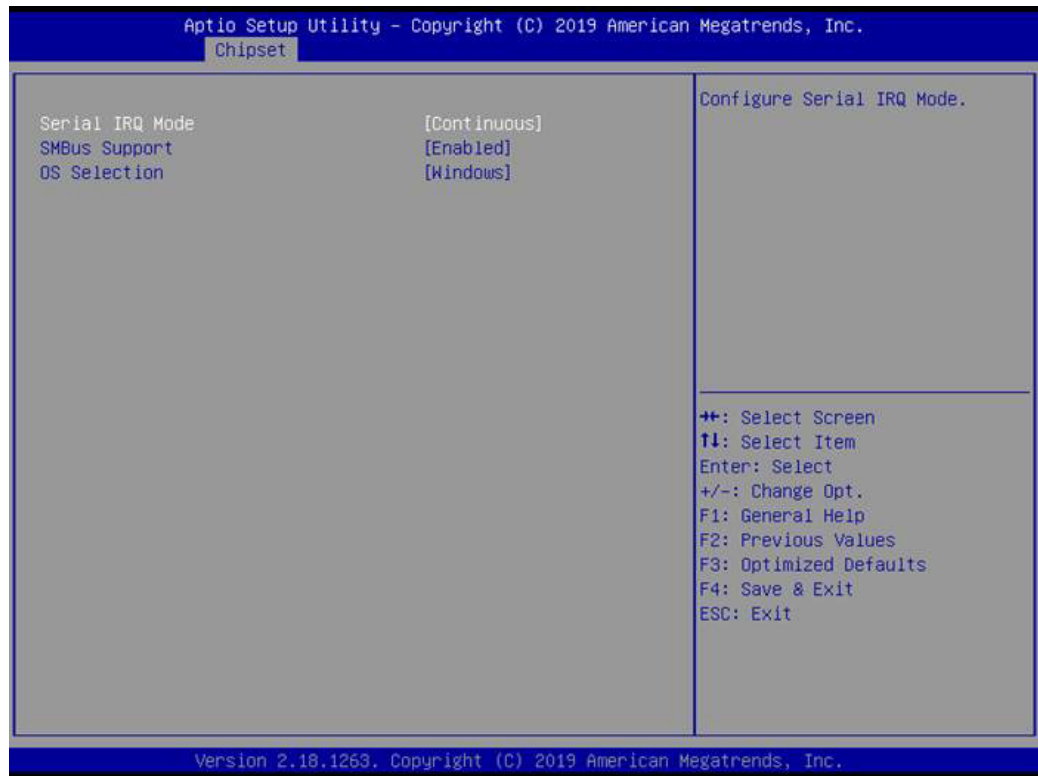

- **Serial IRQ Mode**
Configure Serial IRQ Mode.
- **SMBus Support**
Enable/Disable SMBus Support.
- **OS Selection**
Select the target OS.

3.1.3.3 Uncore Configuration

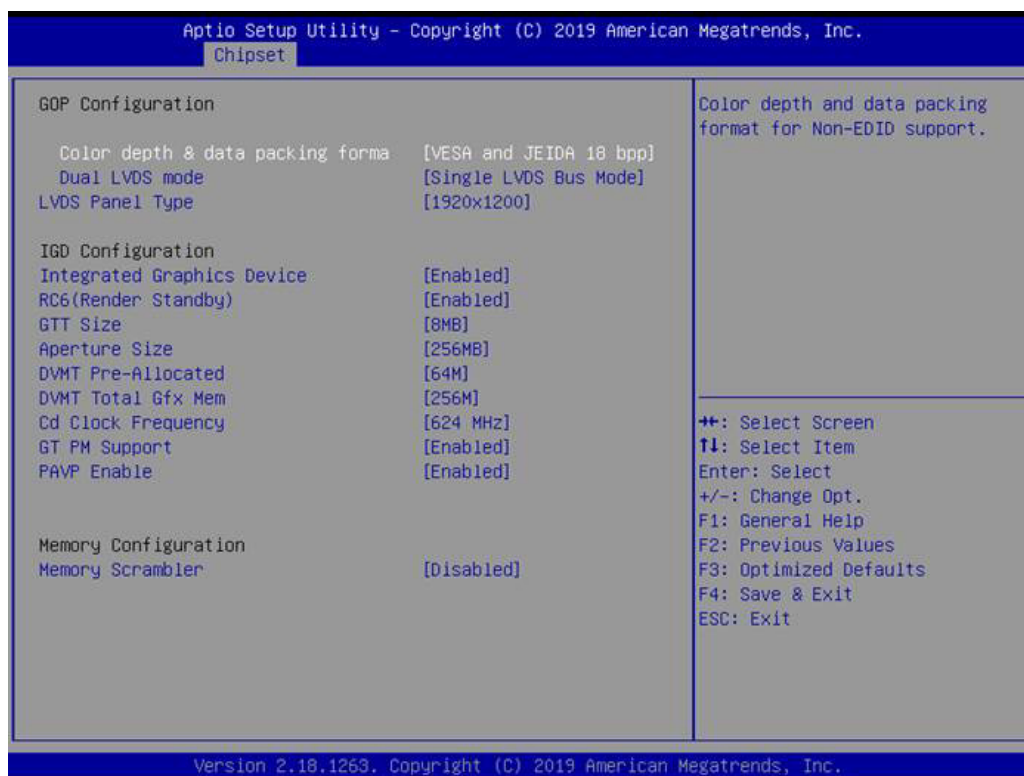

- **Color depth & data packing format**
Select color depth and data packing format for Non-EDID. Default support is enabled.
- **Dual LVDS mode**
Select LVDS bus to Single bus mode or Dual bus mode.
- **LVDS Panel Type**
Select LCD Panel Type.
- **Integrated Graphics Device**
Enable: enables Integrated Graphics Device (IGD) when selected as the Primary Video Adaptor. Disable: disables IGD.
- **RC6 Render Standby)**
Check to enable render standby support.
- **GTT Size**
Select the GTT Size
- **Aperture Size**
Select the Aperture Size.
- **DVMT Pre-Allocated**
Select DVMT 5.0 Pre-Allocated (Fixed) graphics memory size used by the internal graphics device.
- **DVMT Total Gfx Mem**
Select DVMT 5.0 Total Graphic Memory size used by the Internal Graphics Device.
- **Cd Clock Frequency**
Selects the highest Cd Clock frequency supported by the platform.
- **GT PM Support**
Enable/Disable GT PM support.

- **PAVP Enable**
Enable/Disable PAVP.
- **Memory Scrambler**
Enable/Disable Memory Scrambler support.

3.1.3.4 South Cluster Configuration



- **HD-Audio Configuration**
HD-Audio Configuration settings.
- **PCI Express Configuration**
PCI Express Configuration Settings.
- **SATA Drives**
Press <Enter> to select the SATA Drive configuration setup options.
- **SCC Configuration**
SCC Configuration settings.
- **USB Configuration**
USB Configuration settings.
- **Miscellaneous Configuration**
Enable/Disable Misc. Configuration features.

HD-Audio Configuration

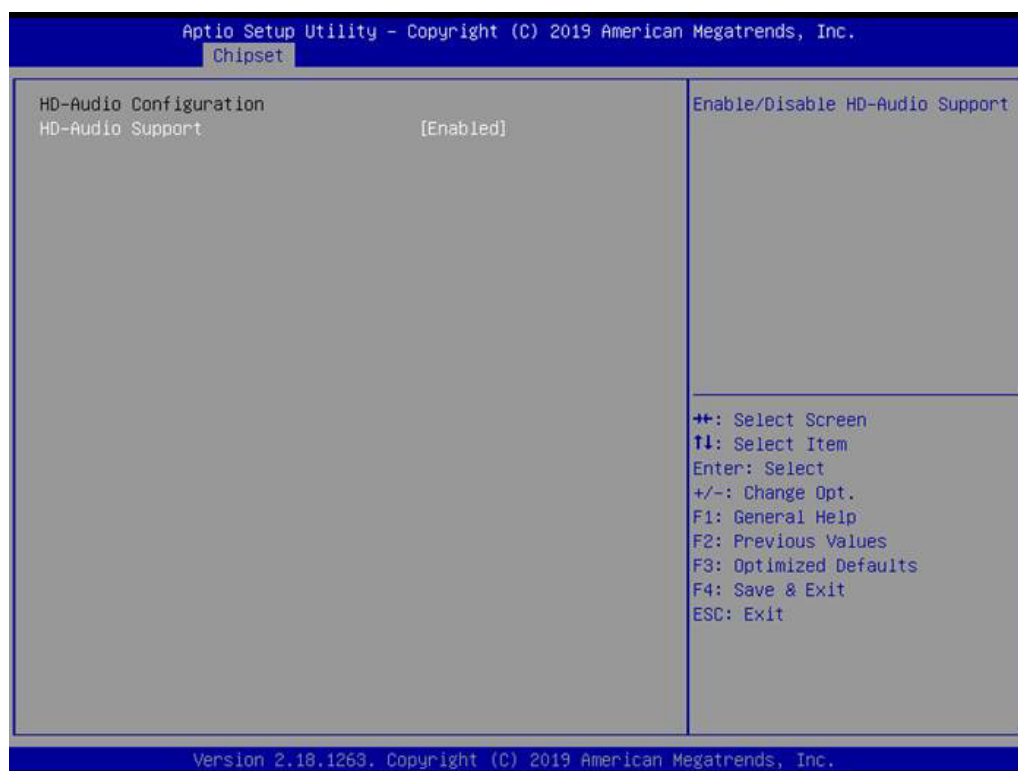

- **HD-Audio Support**
Enable/Disable HD-Audio Support.

PCI Express Configuration



- **PCI Express Clock Gating**
PCI Express Clock Gating Enable/Disable.
- **Peer Memory Write Enable**
Peer Memory Write Enable/Disable.
- **Compliance Mode**
Compliance Mode Enable/Disable.
- **PCI Express Root Port 5 / 6**
Control the PCI Express Root Port.
- **Onboard LAN1/LAN2 Controller**
Select enable or disable Onboard LAN1/LAN2 Controller.
- **LAN Option ROM**
Enabled / Disabled onboard LAN's PXE option ROM.
- **PCIE Wake from S5**
Enable or disable PCIE to wake the system from S5.

SATA Drives



- **Chipset SATA**
Enable or disable the Chipset SATA controller.

SCC Configuration

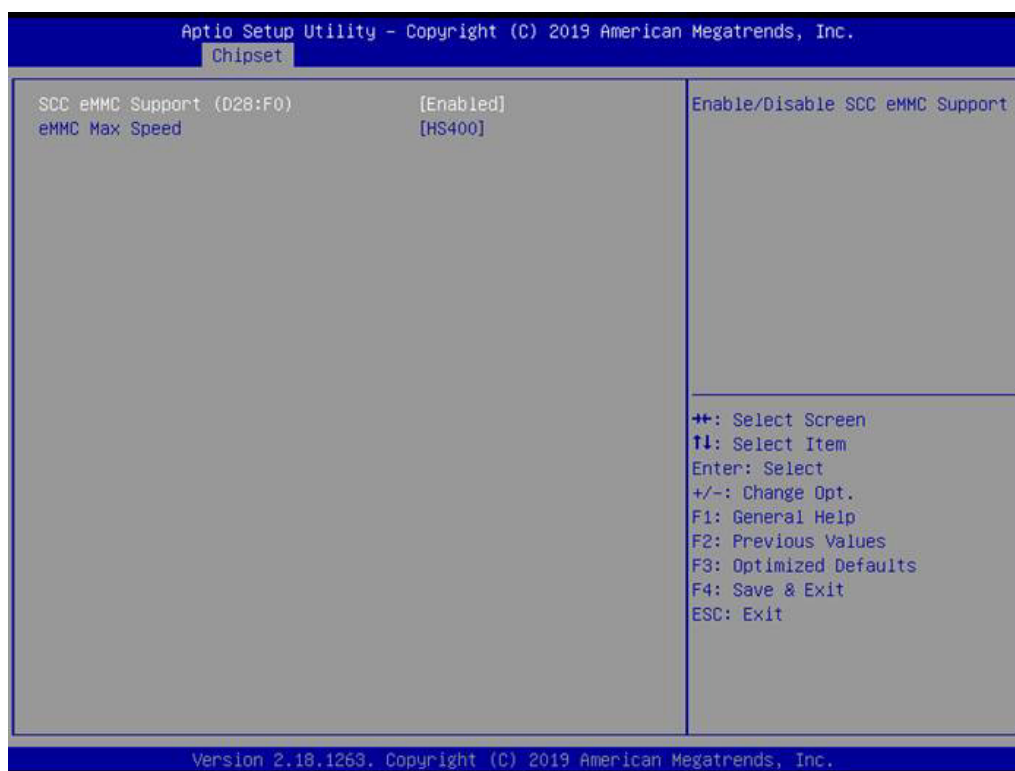

- **SCC eMMC Support (D28:F0)**
Enable/Disable SCC eMMC Support.
- **eMMC Max Speed**
Select the eMMC Max Speed allowed.

USB Configuration

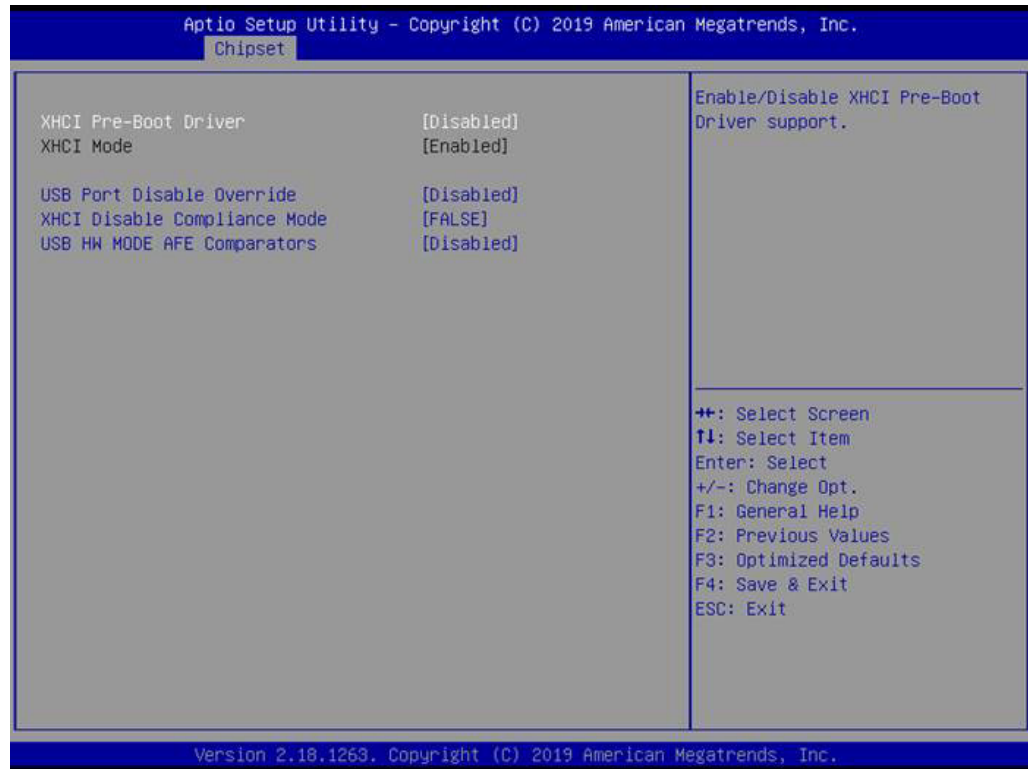

- **XHCI Pre-Boot Driver**
Enable/Disable XHCI Pre-Boot Driver support.
- **USB Port Disable Override**
Selectively Enable/Disable corresponding USB port from reporting a device connection to the controller.
- **XHCI Disable Compliance Mode**
Options to disable XHCI link compliance mode.
- **USB HW MODE AFE Comparators**
Enable/Disable USB HW MODE AFE comparators.

Miscellaneous Configuration

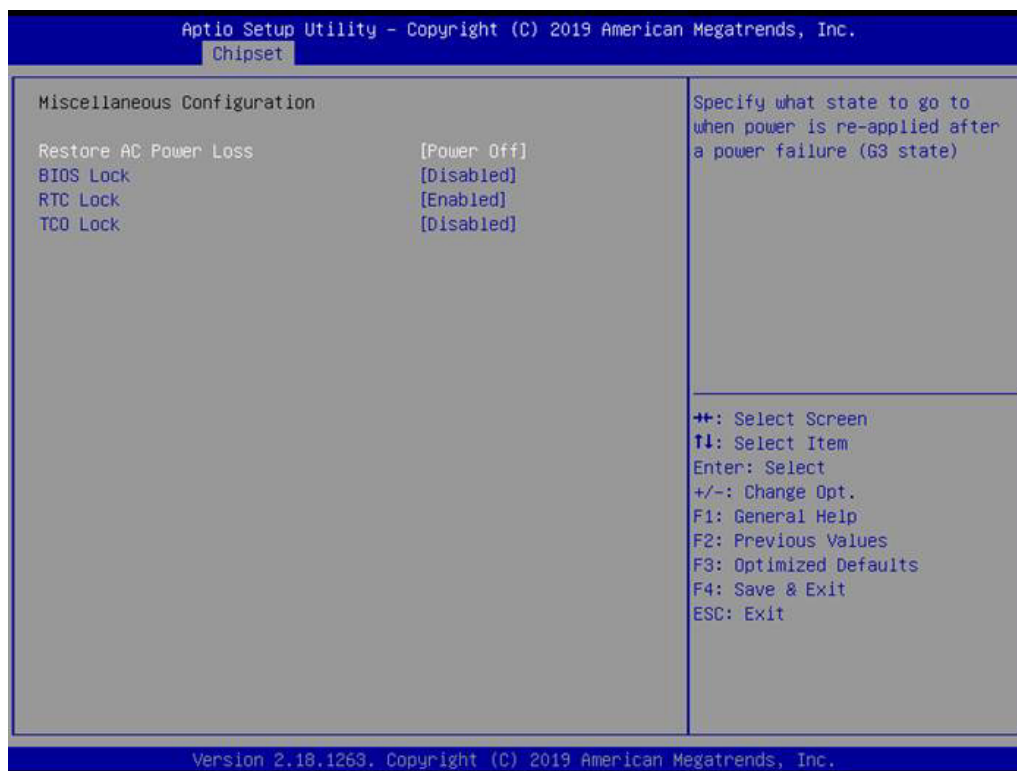

- **Restore AC Power Loss**
Specify what state to go to when power is re-applied after a power failure (G3 state).
- **BIOS Lock**
Enable/Disable the BIOS lock enable feature.
- **RTC Lock**
Enable or disable bytes 38h-3Fh in the upper and lower 128-byte bank of RTC RAM lockdown.
- **TCO SMI Lock**
Enable TCO and lock down TCO.

3.1.4 Security

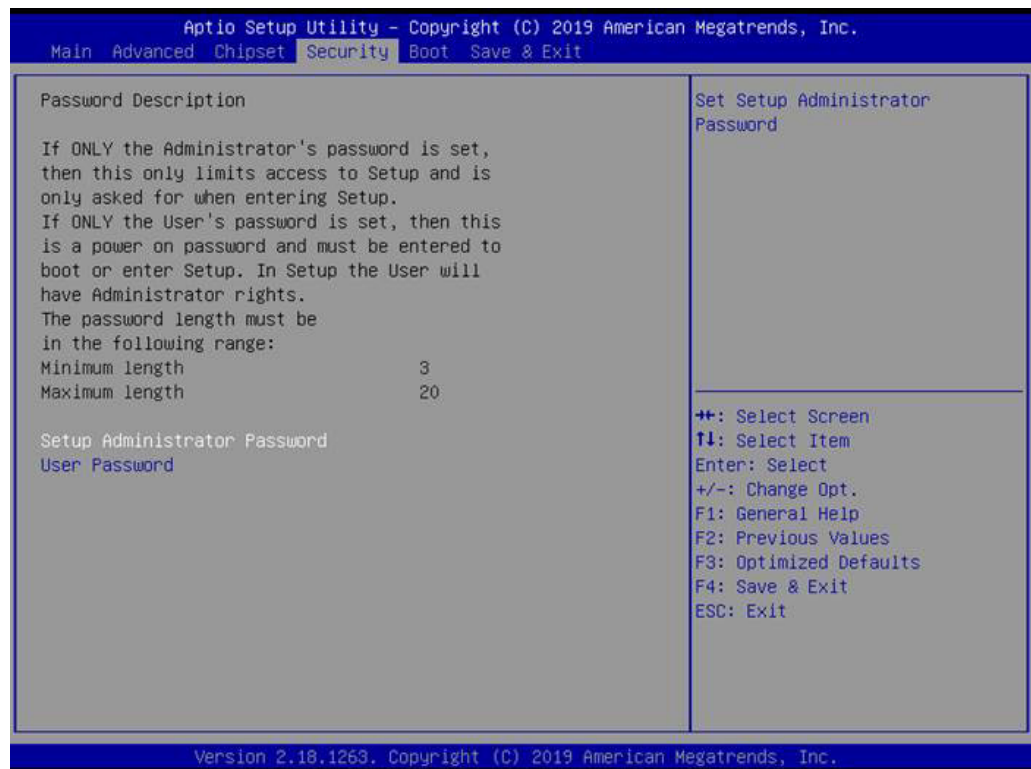

Select Security Setup from the MIO-2361 Setup main BIOS setup menu. All Security-Setup options, such as password protection and virus protection are described in this section. To access the sub menu for the following items, select the item and press <Enter>:

- **Change Administrator / User Password**

Select this option and press <ENTER> to access the sub menu, and then type in the password.

3.1.5 Boot



- **Setup Prompt Timeout**
Number of seconds that the firmware will wait before initiating the original default boot selection. A value of 0 indicates that the default boot selection is to be initiated immediately on boot. A value of 65535 (0xFFFF) indicates that firmware will wait for user input before booting. This means the default boot selection is not automatically started by the firmware.
- **Bootup NumLock State**
Select the keyboard NumLock state.
- **Quiet Boot**
Enables or disables Quiet Boot option.
- **Boot Option #1**
Sets the system boot order.
- **Fast Boot**
Enables or disables boot with initialization of a minimal set of devices required to launch active boot option. Has no effect for BBS boot options.
- **New Boot Option Policy**
Controls the placement of newly detected UEFI boot options.

3.1.6 Save & Exit

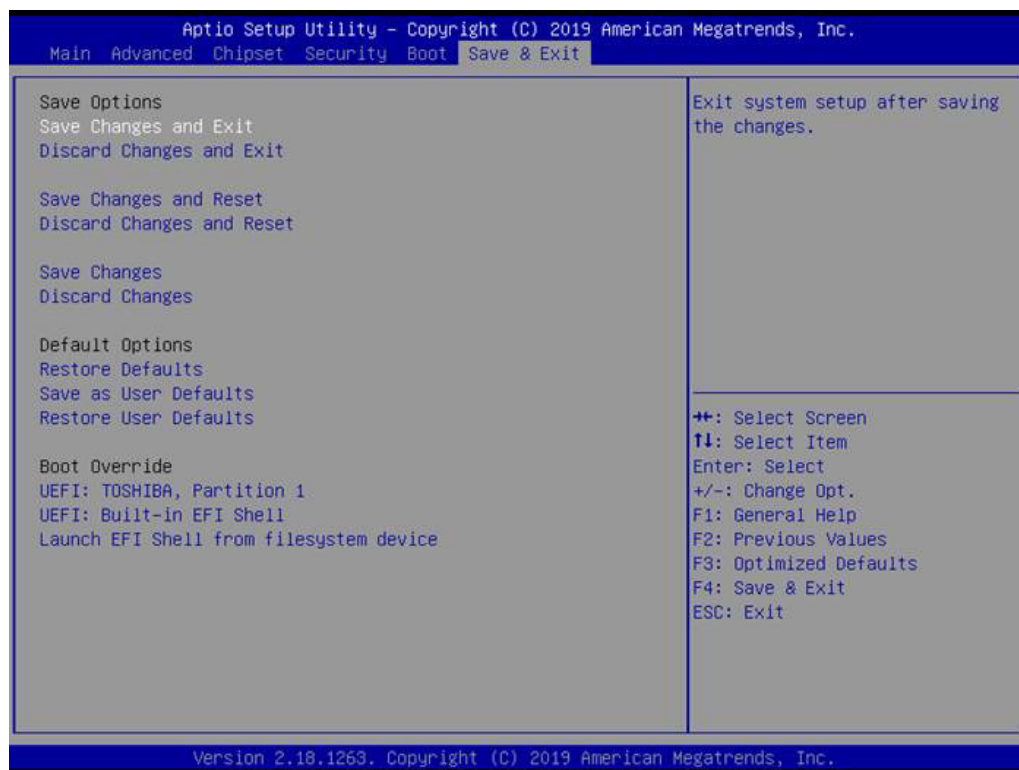

- **Save Changes and Exit**
This item allows you to exit system setup after saving the changes.
- **Discard Changes and Exit**
This item allows you to exit system setup without saving any changes.
- **Save Changes and Reset**
This item allows you to reset the system after saving the changes.
- **Discard Changes and Reset**
This item allows you to rest system setup without saving any changes.
- **Save Changes**
This item allows you to save changes done so far to any of the options.
- **Discard Changes**
This item allows you to discard changes done so far to any of the options.
- **Restore Defaults**
This item allows you to restore/load default values for all the options.
- **Save as User Defaults**
This item allows you to save the changes done so far as user defaults.
- **Restore User Defaults**
This item allows you to restore the user defaults to all the options.
- **Boot Override**
Boot device selection can override your boot priority.

Chapter 4

S/W Introduction &
Installation

4.1 S/W Introduction

We enable Windows embedded software products on Advantech platforms to more effectively support the embedded computing community. Customers are freed from the hassle of dealing with multiple vendors (Hardware suppliers, System integrators, Embedded OS distributor) for projects. Our goal is to make Windows embedded software solutions easily and widely available to the embedded computing community.

4.2 Driver Installation

4.2.1 Windows 10 Professional

To install the drivers, insert the driver CD into DVD-ROM, select the drivers that need to be installed, then launch setup file under each function folder and follow the Driver Setup instructions to complete the process.

4.2.2 Other OS

To install the drivers for another Windows OS or Linux, please browse the CD to run the setup file under the appropriate OS folder(s).

4.3 Value-Added Software Services

Software API: An interface that defines the ways by which an application program may request services from libraries and/or operating systems. Provides not only the underlying drivers required but also a rich set of user-friendly, intelligent and integrated interfaces, which speeds development, enhances security and offers add-on value for Advantech platforms.

4.3.1 SUSI Introduction

To make hardware easier and more convenient to access for programmers, Advantech has released a suite of API (Application Programming Interface) in the form of a program library. The program Library is called Secured and Unified Smart Interface or SUSI for short.

In modern operating systems, user applications cannot access hardware directly so drivers are required. User space applications access hardware through drivers. Different operating systems usually define different interface for drivers. This means that user space applications call different functions for hardware access in different operating systems. To provide a uniform interface for accessing hardware, an abstraction layer is built on top of the drivers and SUSI is such an abstraction layer. SUSI provides a uniform API for application programmers to access the hardware functions in different Operating Systems and on different Advantech hardware platforms.

Application programmers can invoke the functions exported by SUSI instead of calling the drivers directly. The benefit of using SUSI is portability. The same set of APIs is defined for different Advantech hardware platforms. Also, the same API set is implemented in different Operating Systems. This user's manual describes some sample programs and the API in SUSI. The hardware functions currently supported by SUSI can be grouped into a few categories including Watchdog, I²C, SMBus, GPIO, and VGA control. Each category of API in SUSI is briefly described below.

4.3.2 Software APIs

4.3.2.1 The GPIO API

General Purpose Input/Output is a flexible parallel interface that allows a variety of custom connections. It allows users to monitor the level of signal input or set the output status to switch on/off a device. Our API also provides Programmable GPIO, which allows developers to dynamically set the GPIO input or output status.

4.3.2.2 The SMBus API

The System Management Bus (SMBus) is a two-wire interface defined by Intel Corporation in 1995. It is based on the same principles of operation of I²C and is used in personal computers and servers for low-speed system management communications. Nowadays, it can be seen in many types of embedded systems. As with other API in SUSI, the SMBus API is available on many platforms including Windows 10.

4.3.2.3 The Display Control API

There are two kinds of VGA control APIs, backlight on/off control and brightness control. Backlight on/off control allows a developer to turn on or off the backlight, and to control brightness smoothly.

1. Brightness Control
 - The Brightness Control API allows a developer to interface with an embedded device to easily control brightness.
2. Backlight Control
 - The Backlight API allows a developer to control the backlight (screen) on/off in an embedded device.

4.3.2.4 The Watchdog API

A watchdog timer (abbreviated as WDT) is a hardware device which triggers an action, e.g. rebooting the system, if the system does not reset the timer within a specific period of time. The WDT API in SUSI provides developers with functions such as starting the timer, resetting the timer, and setting the timeout value if the hardware requires customized timeout values.

4.3.2.5 The Hardware Monitor API

The hardware monitor (abbreviated as HWM) is a system health supervision capability achieved by placing certain I/O chips along with sensors for inspecting the target of interests for certain condition indexes, such as fan speed, temperature and voltage etc.

However, due to the inaccuracy among many commercially available hardware monitoring chips, Advantech has developed a unique scheme for hardware monitoring - achieved by using a dedicated micro-processor with algorithms specifically designed for providing accurate, real-time and reliable data content; helping protect your system in a more reliable manner.

4.3.2.6 The Power Saving API

1. CPU Speed
 - Make use of Intel SpeedStep technology to reduce power consumption. The system will automatically adjust the CPU Speed depending on system loading.
2. System Throttling
 - Refers to a series of methods for reducing power consumption in computers by lowering the clock frequency. APIs allow the user to lower the clock from 87.5% to 12.5%.

4.3.3 SUSI Installation

SUSI supports many different operating systems. Each subsection below describes how to install SUSI and related software on a specific operating system. Please refer to the subsection matching your operating system.

4.3.3.1 Windows 10

In Windows 10, you can install the library, drivers and demo programs onto the platform easily using the SUSI Library Installer tool. After the installer has executed, the SUSI Library and related files for Windows 10 can be found in the target installation directory. The files are listed in the following table.

Directory	Contents
\Library	<ul style="list-style-type: none">■ Susi.lib Library for developing the applications on Windows 10.■ Susi.dll Dynamic library for SUSI on Windows 10.
\Demo	<ul style="list-style-type: none">■ SusiDemo.EXE Demo program on Windows® 7.■ Susi.dll Dynamic library for SUSI on Windows 10.
\Demo\SRC	Source code of the demo program on Windows 10.

The following section illustrates the installation process.

Note! *The SUSI Library Installer screen shots shown below are examples only. Your screens may vary depending on your particular version.*



1. Extract Susi.zip.
2. Double-click the "Setup.exe" file.

The installer searches for a previous installation of the SUSI Library. If it locates one, a dialog box opens asking whether you want to modify, repair or remove the software. If a previous version is located, please see the [Maintenance Setup] section. If it is not located, an alternative window appears. Click Next.

4.3.4 SUSI Sample Programs

Sample Programs

The sample programs demonstrate how to incorporate SUSI into your program. The sample programs run in graphics mode in Windows® 7 are described in the subsections below.

Windows Graphics Mode

Each demo application contains an executable file SusiDemo.exe, a shared library Susi.dll and source code within the release package.

SusiDemo.exe is an executable file and it requires the shared library, Susi.dll, to demonstrate the SUSI functions. The source code of SusiDemo.exe must be compiled under Microsoft Visual C++ 6.0 on Windows 10. Developers must add the header file Susi.h and library Susi.lib to their own projects when they want to develop something with SUSI.

SusiDemo.exe

The SusiDemo.exe test application is an application which uses all functions of the SUSI Library. It has five major function blocks: Watchdog, GPIO, SMBus, I²C and VGA control. The following screen shot appears when you execute SusiDemo.exe. You can click function tabs to select test functions respectively. Some function tabs will not show on the test application if your platform does not support such functions. For a complete support list, please refer to Appendix A which describes the steps to test all functions of this application.

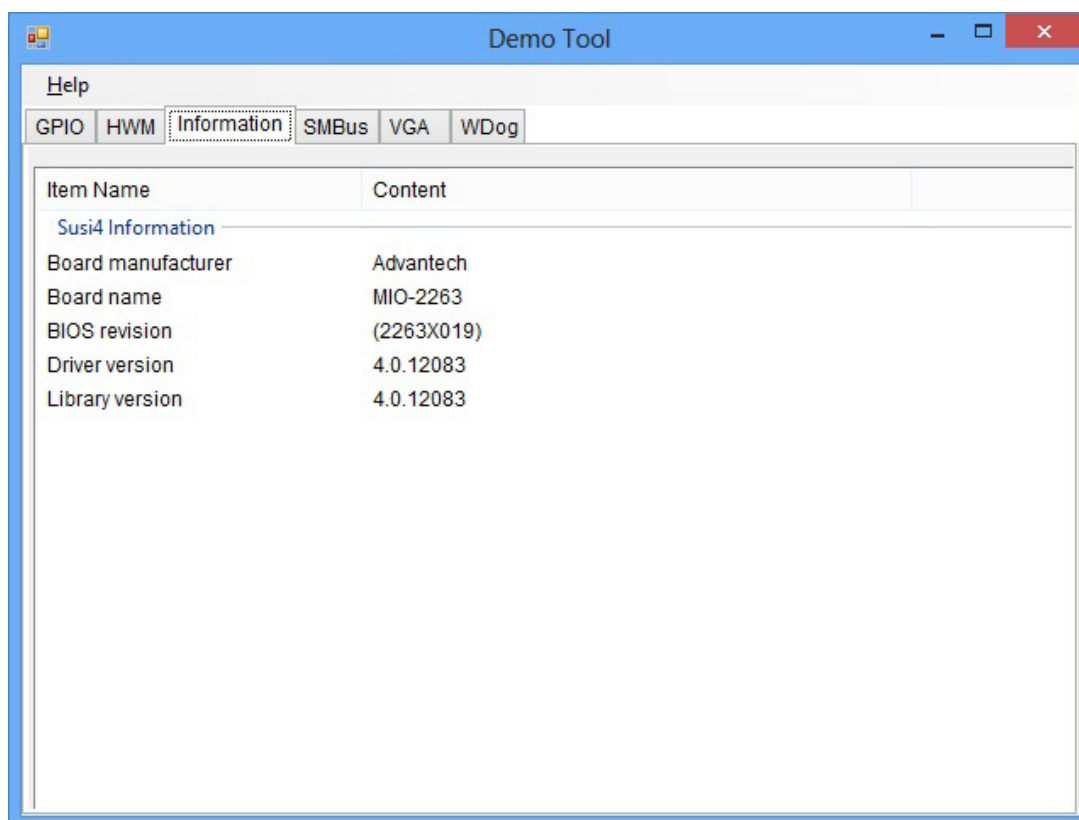

GPIO

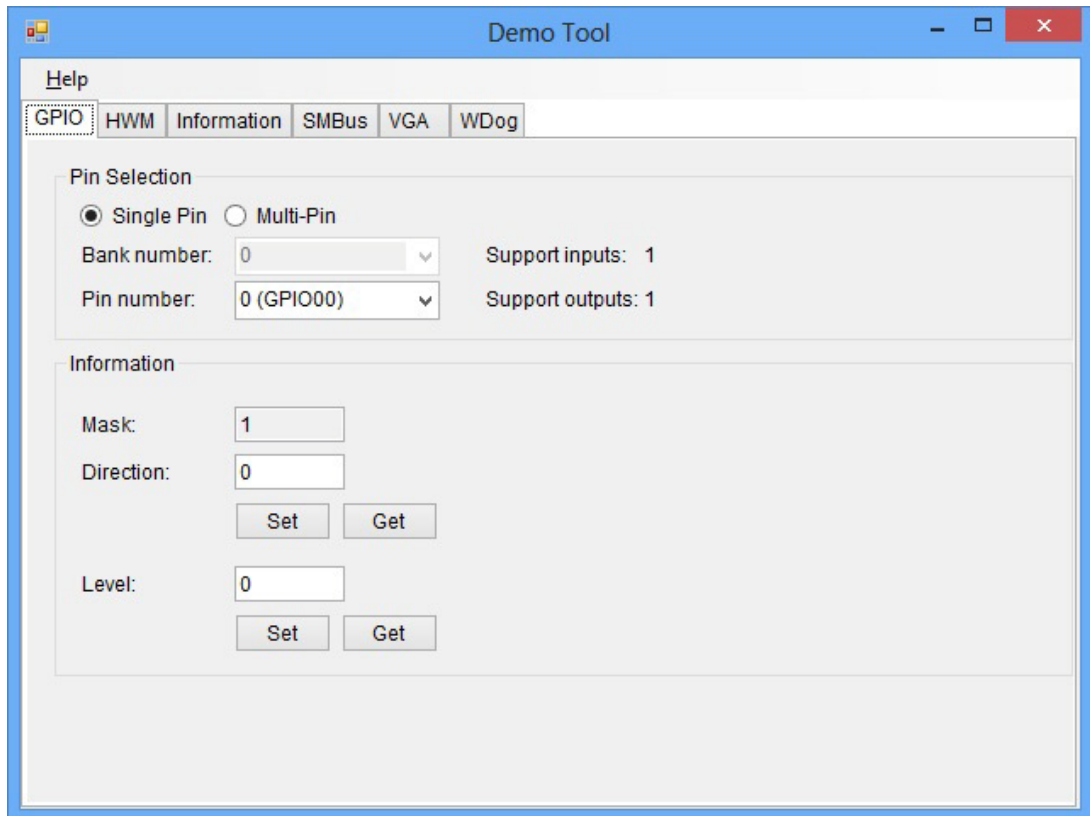

When the application is executed, it will display GPIO information in the GPIO INFORMATION group box. It displays the number of input pins and output pins. You can click the radio button to choose to test either the single pin function or multiple pin functions. The GPIO pin assignments of the supported platforms are located in Appendix B.

- Test Read Single Input Pin
 - Click the radio button- Single-Pin.
 - Key in the pin number to read the value of the input pin. The Pin number starts from '0'.
 - Click the READ GPIO DATA button and the status of the GPIO pin will be displayed in (R/W) Result field.

- Test Read Multiple Input Pin
 - Click the radio button- Multi-Pin.
 - Key in the pin number from '0x01' to '0x0F' to read the value of the input pin. The pin numbers are ordered bitwise, i.e. bit 0 stands for GPIO 0, bit 1 stands for GPIO 1, etc. For example, if you want to read pin 0, 1, and 3, the pin numbers should be '0x0B'.
 - Click READ GPIO DATA button and the status of the GPIO pins will be displayed in (R/W) the result field.

- Test Write Single Output Pin
 - Click the radio button- Single-Pin.
 - Key in the pin numbers you want to write. Pin numbers starting from '0'.
 - Key in the value either '0' or '1' in (R/W) Result field to write the output pin you chose above step.
 - Click the WRITE GPIO DATA button to write the GPIO output pin.

- Test Write Multiple Output Pins
 - Click the radio button- Multi-Pin.
 - Key in the pin number from '0x01' to '0x0F' to choose the multiple pin numbers to write the value of the output pin. The pin numbers are ordered bitwise, i.e. bit 0 stands for GPIO 0, bit 1 stands for GPIO 1, etc. For example, if you want to write pin 0, 1, and 3, the pin numbers should be '0x0B'.
 - Key in the value in (R/W) Result field from '0x01' to '0x0F' to write the value of the output pin. The pin numbers are ordered bitwise, i.e. bit 0 stands for GPIO 0, bit 1 stands for GPIO 1, etc. For example, if you want to set pin 0 and 1 high, 3 to low, the pin number should be '0x0B', and then you should key in the value '0x0A' to write.
 - Click the WRITE GPIO DATA button to write the GPIO output pins.

SMBus

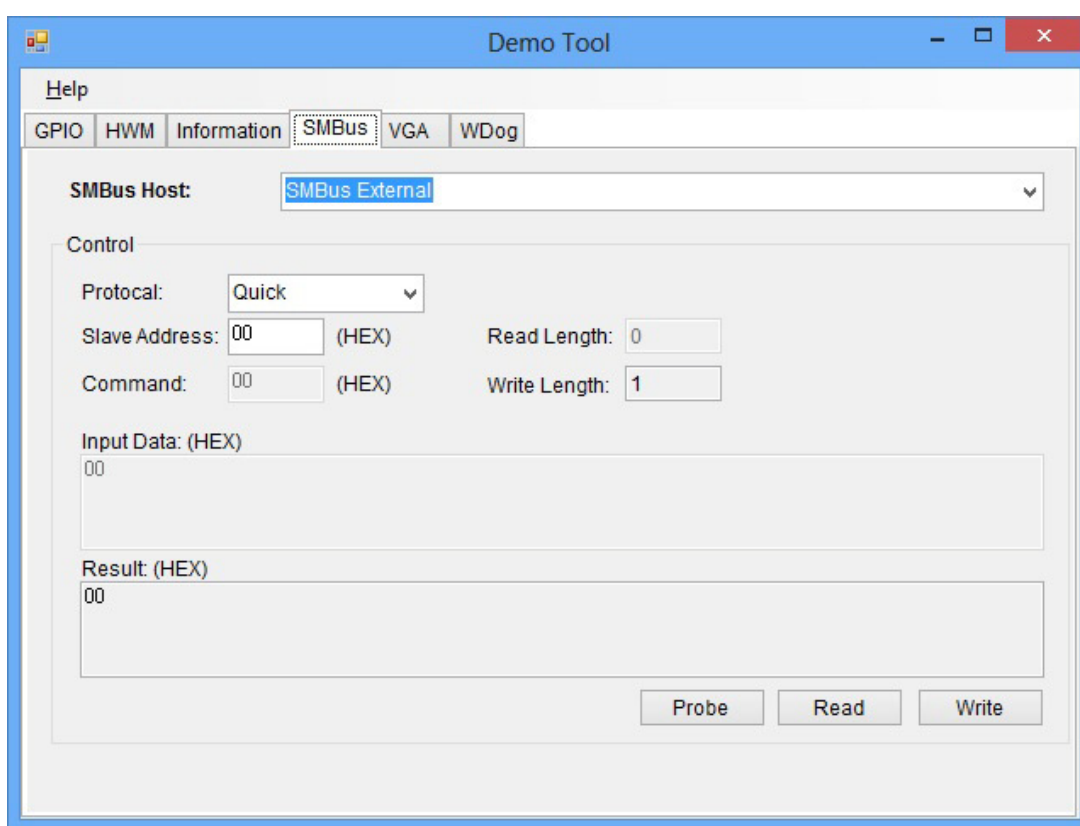

When the application has executed, you can click the radio button to choose to test each access mode, i.e. Access a byte, Access multiple bytes and Access a word. All data must be read or written in hexadecimal except the numbers for the radio button: Access multiple bytes mode must be written in decimal. You can test the functionalities of the watchdog as follows:

- Read a byte
 - Click the radio button- Access a byte.
 - Key in the slave device address in the Slave address field.
 - Key in the register offset in the Register Offset field.
 - Click the READ SMBus DATA button and a byte of data from the device will be shown in the Result field.

-
- Write a byte
 - Click the radio button- Access a byte.
 - Key in the slave device address in Slave address field.
 - Key in the register offset in Register Offset field.
 - Key the desired data in the Result field to write to the device.
 - Click the WRITE SMBus DATA button and then the data will be written to the device through SMBus.

 - Read a word
 - Click the radio button- Access a word.
 - Key in the slave device address in the Slave address field.
 - Key in the register offset in the Register Offset field.
 - Click the READ SMBus DATA button and then a word of data from the device will be shown on the Result field.

 - Write a word
 - Click the radio button- Access a word.
 - Key in the slave device address in the Slave address field.
 - Key in the register offset in the Register Offset field.
 - Key in the desired data, such as 0x1234, in the Result field to write to the device.
 - Click the WRITE SMBus DATA button and the data will be written to the device through the SMBus.

 - Read Multiple bytes
 - Click the radio button- Access multiple bytes.
 - Key in the slave device address in the Slave address field.
 - Key in the register offset in the Register Offset field.
 - Key in the desired number of bytes, such as 3, in the right side field of radio button- Access multiple bytes. The number must be written in decimal.
 - Click the READ SMBus DATA button then all data from the device will be divided from each other by commas and shown in the Result field.

 - Write Multiple bytes
 - Click the radio button- Access multiple bytes.
 - Key in the slave device address in the Slave address field.
 - Key in the register offset in the Register Offset field.
 - Key in the desired number of bytes, such as 3, in the right side field of the radio button- Access multiple bytes. The number must be written in decimal.
 - Key in all the desired data in the Result field in hexadecimal format, divided by commas, for example, 0x50,0x60,0x7A.
 - Click the WRITE SMBus DATA button and all of the data will be written to the device through the SMBus.

Display Control

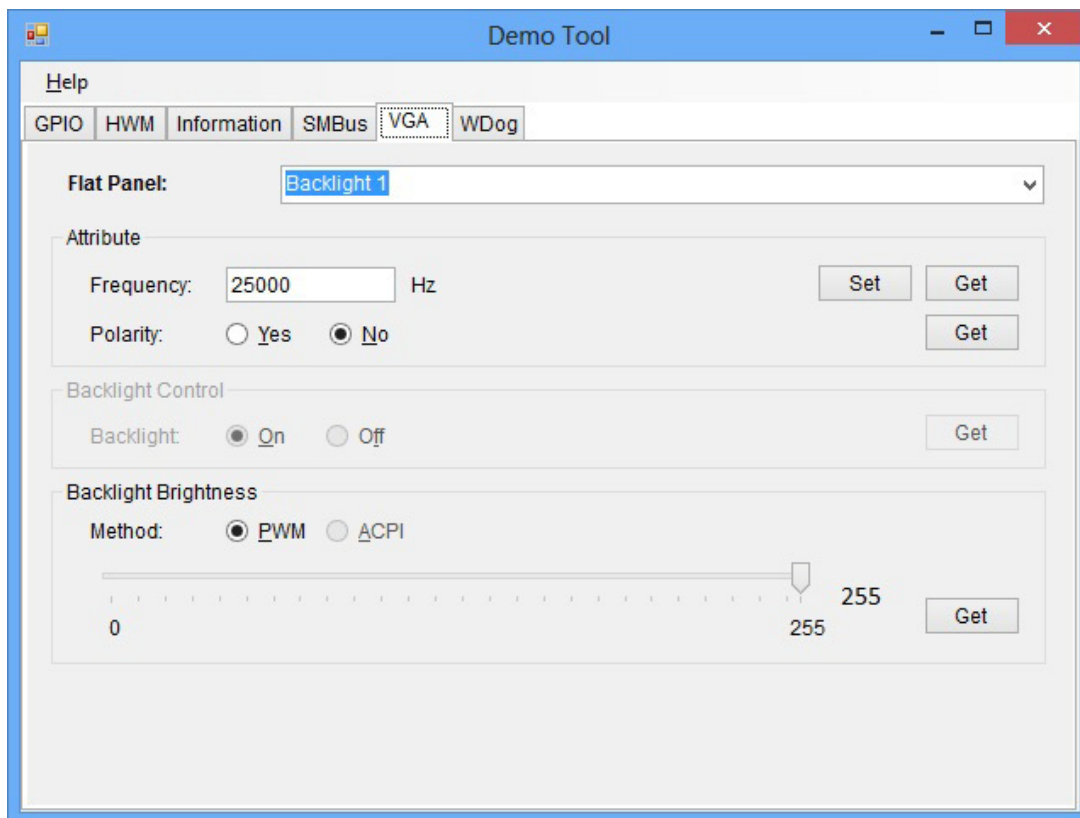

When the application is executed, it will display two blocks of VGA control functions. The application can turn on or turn off the screen shot freely, and it also can tune the brightness of the panels if your platform is supported. You can test the functionality of VGA control as follows:

- **Screen on/off control**
 - Click the radio button ON or push the key F11 to turn on the panel screen.
 - Click the radio button OFF or push the key F12 to turn off the panel screen.
 - The display chip of your platform must be in the support list in Appendix A, or this function cannot work.
- **Brightness control**
 - Move the slider in increments, using either the mouse or the direction keys, or click the UP button to increase the brightness.
 - Move the slider in decrements, using either the mouse or the direction keys, or click the DOWN button to decrease the brightness.

Watchdog

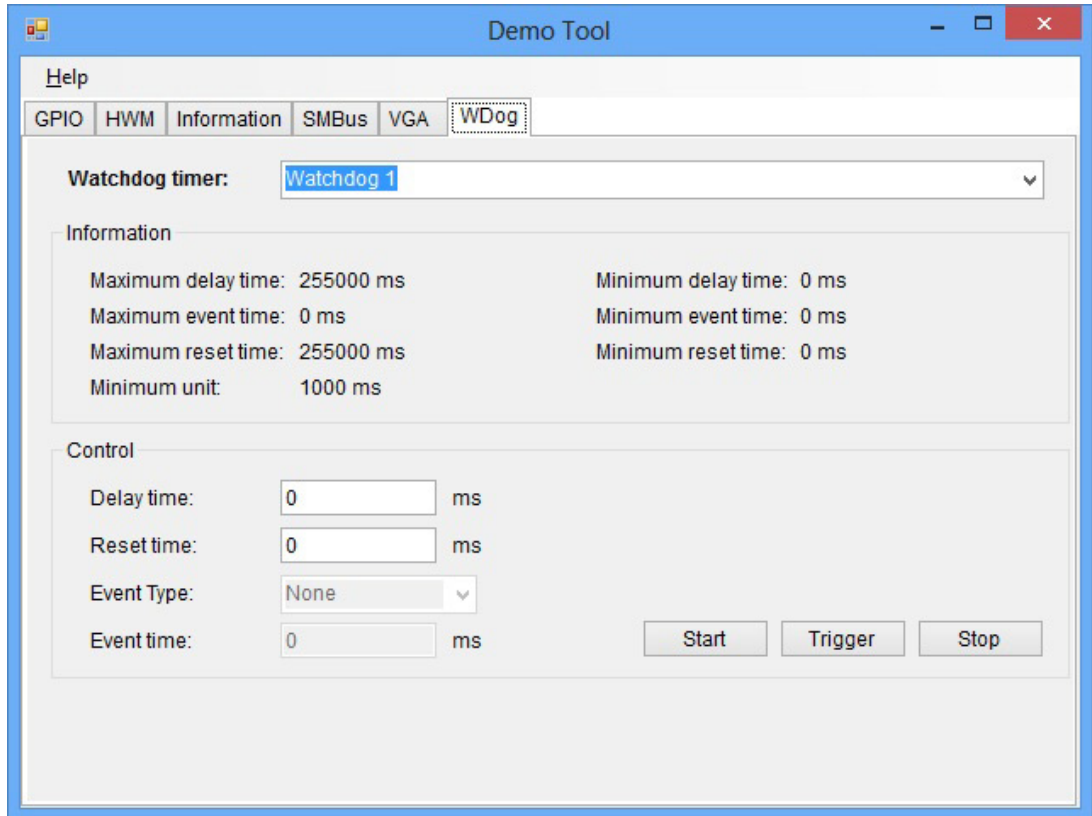

When the application is executed, it will display watchdog information in the WATCHDOG INFORMATION group box. It displays max timeout, min timeout, and timeout steps in milliseconds. For example, a 1~255 seconds watchdog will have 255000 max timeout, 1000 min timeout, and 1000 timeout steps. You can test the functionality of the watchdog as follows:

- Set the timeout value 3000 (3 sec.) in the SET TIMEOUT field and set the delay value 2000 (2 sec.) in the SET DELAY field, then click the START button. The Timeout Countdown field will countdown the watchdog timer and display 5000 (5 sec.).
- Before the timer counts down to zero, you can reset the timer by clicking the REFRESH button. After you click this button, the Timeout Countdown field will display the value of the SET TIMEOUT field.
- If you want to stop the watchdog timer, just click the STOP button.

Hardware Monitor

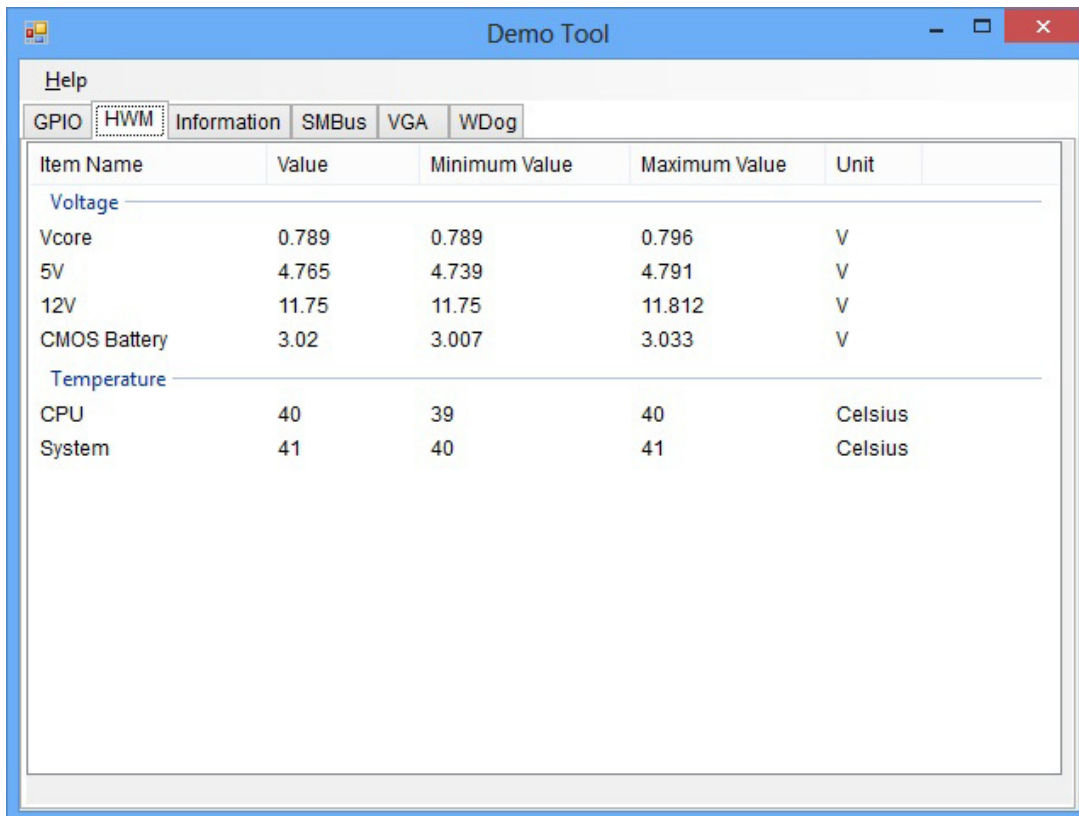

The screenshot shows a window titled "Demo Tool" with a menu bar containing "Help" and a tabbed interface with "GPIO", "HWM", "Information", "SMBus", "VGA", and "Wdog". The "HWM" tab is active, displaying a table of hardware monitoring data.

Item Name	Value	Minimum Value	Maximum Value	Unit
Voltage				
Vcore	0.789	0.789	0.796	V
5V	4.765	4.739	4.791	V
12V	11.75	11.75	11.812	V
CMOS Battery	3.02	3.007	3.033	V
Temperature				
CPU	40	39	40	Celsius
System	41	40	41	Celsius

When the Monitor application is executed by clicking the button, hardware monitoring data values will be displayed. If certain data values are not supported by the platform, the correspondent data field will be grayed-out with a value of 0.

For more details on MIO-2361 software API, please contact your dealer or Advantech AE.

Appendix **A**

PIN Assignments

A.1 Jumper Settings

SW1	Auto Power On
Part Number	00
Footprint	SW_4x2P_50_260x220
Setting	Function
(1-8)	ON: AT mode OFF: ATX mode

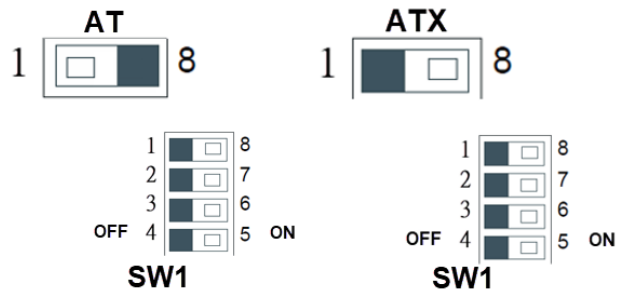

SW1	LVDS VCON
Part Number	00
Footprint	SW_4x2P_50_260x220
Setting	Function
(2-7)	LVDS JEIDA/VESA select ON: GND OFF: +V3.3

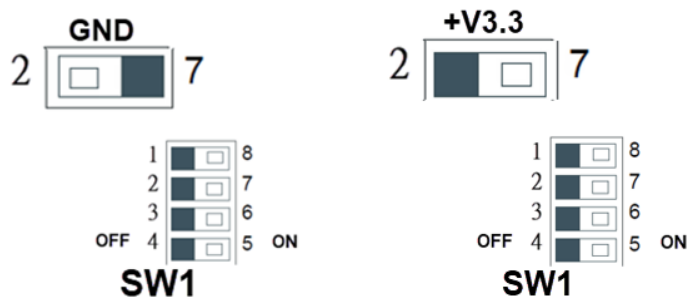

SW1	DCIN 12V
Part Number	00
Footprint	SW_4x2P_50_260x220
Setting	Function
(4-5)	ON: DCVIN=12V OFF: DCIN=24V
SW2	DCIN 12V
Part Number	00
Footprint	SW_4x2P_50_260x220
Setting	Function
(1-8)	ON: DCVIN=12V OFF: DCIN=24V
(2-7)	ON: DCVIN=12V OFF: DCIN=24V

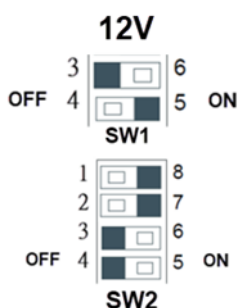

SW1	DCIN 24V
Part Number	00
Footprint	SW_4x2P_50_260x220
Setting	Function
(3-6)	ON: DCVIN=24V OFF: DCIN=12V
SW2	DCIN 24V
Part Number	00
Footprint	SW_4x2P_50_260x220
Setting	Function
(3-6)	ON: DCVIN=24V OFF: DCIN=12V
(4-5)	ON: DCVIN=24V OFF: DCIN=12V

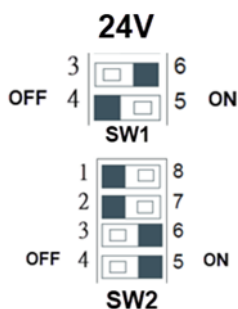

A.2 Connectors

Table A.1: Connector list

CN1	12 V Power Input
CN2	DC JACK
CN4	Battery
CN9	LAN
CN10	LAN
CN12	48-bit LVDS Panel
CN13	HDMI
CN15	SATA
CN16	Audio
CN18	Mini PCIE
CN22	External USB3.0
CN23	SMBus
CN33	Internal USB
CN34	GPIO
CN35	GPIO
CN45	Front panel
CN54	COM1/COM2
CN57	Inverter Power Output

J3	LCD Power
Part Number	1653003260
Footprint	HD_3x2P_79
Description	PIN HEADER 3x2P 2.0mm 180D(M) SMD 21N22050
Setting	Function
(1-3)*	+3.3V
(3-5)	+5V
(3-4)	+12V

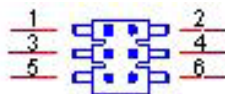

CN1	12 V Power Input
Part Number	1655003962
Footprint	WF_2P_156_D_A3963WV2
Description	WAFER 2P 3.96mm 180D(M) DIP A3963WV2-2P
Pin	Pin Name
1	GND
2	+VIN

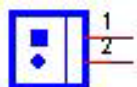

CN2	DCJACK_3
Part Number	00
Footprint	PJ_3P_SCD556DCS113B00G
Description	
Pin	Pin Name
1	+VIN
2	GND

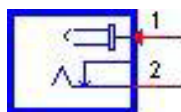

CN4	Battery
Part Number	1655902032
Footprint	WHL2V-125
Description	WAFER BOX 2P 1.25mm 180D(M) DIP 53047-0210
Pin	Pin Name
1	+3V
2	GND



CN9	LAN1
Part Number	1652004356
Footprint	RJ45_14P_RT7-194AAM1A
Description	PHONE JACK RJ45 14P 90D(F) DIP RT7-194AAM1A
Pin	Pin Name
1	BI_DA+(GHz)
2	BI_DA-(GHz)
3	BI_DB+(GHz)
4	BI_DC+(GHz)
5	BI_DC-(GHz)
6	BI_DB-(GHz)
7	BI_DD+(GHz)
8	BI_DD-(GHz)

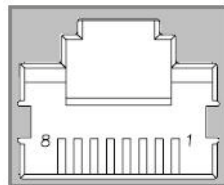

CN10	LAN2
Part Number	1652004356
Footprint	RJ45_14P_RT7-194AAM1A
Description	PHONE JACK RJ45 14P 90D(F) DIP RT7-194AAM1A
Pin	Pin Name
1	BI_DA+(GHz)
2	BI_DA-(GHz)
3	BI_DB+(GHz)
4	BI_DC+(GHz)
5	BI_DC-(GHz)
6	BI_DB-(GHz)
7	BI_DD+(GHz)
8	BI_DD-(GHz)

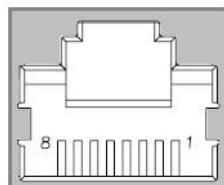

CN12		48-bit LVDS Panel	
Part Number	1653006918-01		
Footprint	SPH20X2		
Description			
Pin	Pin Name		
1	+5V or +3.3V		
2	+5V or +3.3V		
3	GND		
4	GND		
5	+5V or +3.3V		
6	+5V or +3.3V		
7	LVDS0_D0-		
8	LVDS1_D0-		
9	LVDS0_D0+		
10	LVDS1_D0+		
11	GND		
12	GND		
13	LVDS0_D1-		
14	LVDS1_D1-		
15	LVDS0_D1+		
16	LVDS1_D1+		
17	GND		
18	GND		
19	LVDS0_D2-		
20	LVDS1_D2-		
21	LVDS0_D2+		
22	LVDS1_D2+		
23	GND		
24	GND		
25	LVDS0_CLK-		
26	LVDS1_CLK-		

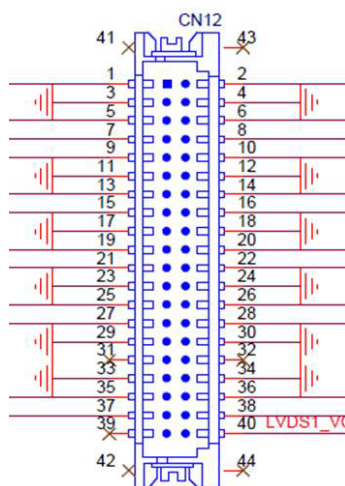

CN12	48-bit LVDS Panel
Part Number	1653006918-01
Footprint	SPH20X2
Description	
Pin	Pin Name
27	LVDS0_CLK+
28	LVDS1_CLK+
29	GND
30	GND
31	NC
32	NC
33	GND
34	GND
35	LVDS0_D3-
36	LVDS1_D3-
37	LVDS0_D3+
38	LVDS1_D3+
39	NC
40	VCON

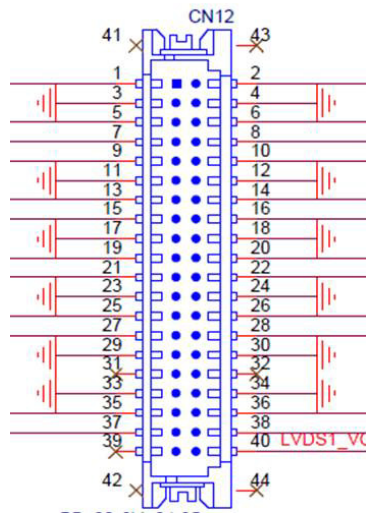

CN15	SATA
Part Number	1654013615-01
Footprint	sata_7p_watf-07dbn6sb1u
Description	
Pin	Pin Name
1	GND
2	TX+
3	TX-
4	GND
5	RX-
6	RX+
7	GND

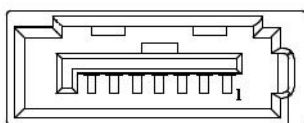

CN16	Audio
Part Number	1653004099
Footprint	HD_5x2P_79_23N685B-10M10
Description	BOX HEADER 5x2P 2.00mm 180D(M) SMD 23N685B-10M10
Pin	Pin Name
1	LOUTR
2	LINR
3	GND
4	GND
5	LOUTL
6	LINL
7	GND
8	GND
9	MIC1R
10	MIC1L

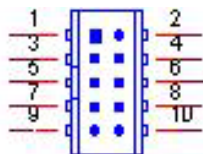

CN18	Mini PCIE
Part Number	1654002538
Footprint	FOX_AS0B226-S68K7F
Description	MINI PCI E 52P 6.8mm 90D SMD AS0B226-S68Q-7H
Pin	Pin Name
1	WAKE#
2	+3.3VSB
3	NC
4	GND
5	NC
6	+1.5V
7	CLKREQ#
8	NC
9	GND
10	NC
11	REFCLK-
12	NC
13	REFCLK+
14	NC
15	GND
16	NC
17	NC
18	GND
19	NC
20	W_DISABLE#
21	GND
22	PERST#
23	PERn0
24	+3.3VSB
25	PERp0
26	GND

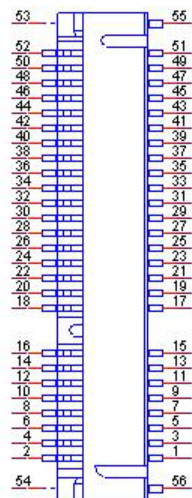

CN18	Mini PCIE
Part Number	1654002538
Footprint	FOX_AS0B226-S68K7F
Description	MINI PCI E 52P 6.8mm 90D SMD AS0B226-S68Q-7H
Pin	Pin Name
27	GND
28	+1.5V
29	GND
30	SMB_CLK
31	PETn0
32	SMB_DAT
33	PETp0
34	GND
35	GND
36	USB D-
37	GND
38	USB D+
39	+3.3VSB
40	GND
41	+3.3VSB
42	NC
43	NC
44	NC
45	NC
46	NC
47	NC
48	+1.5V
49	NC
50	GND
51	NC
52	+3.3VSB

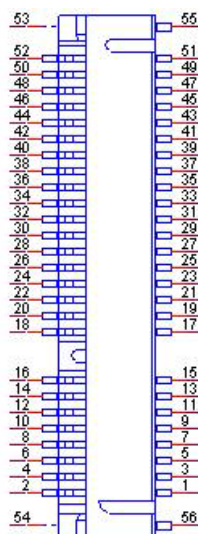

CN22	External USB3.0
Part Number	1654012030-01
Footprint	USB_9X2P_USB5-18F5-BNR0-10
Description	
Pin	Pin Name
1	+5V
2	D-
3	D+
4	GND
5	SSRX-
6	SSRX+
7	GND
8	SSTX-
9	SSTX+

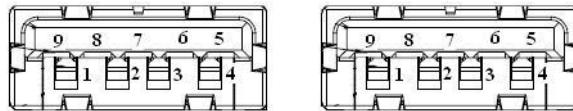

CN23	SMBus
Part Number	1655904020
Footprint	FPC4V-125M
Description	WAFER 4P 1.25mm 180D(M) SMD 85205-04001
Pin	Pin Name
1	GND
2	SMB_DAT
3	SMB_CLK
4	+5V

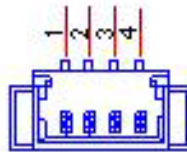

CN31	IS200 Debug Port
Part Number	1654010149
Footprint	FPCCON_8P_20_88706-0801
Description	
Pin	Pin Name
1	GND
2	TMS
3	TDI
4	TDO
5	TCK
6	CLK
7	+V3.3RDC
8	+V3.3EC

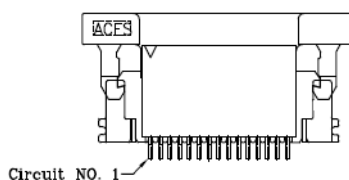

CN33	Internal USB
Part Number	1653004515
Footprint	HD5x2P_79_23N685B-10M10_N10
Description	
Pin	Pin Name
1	+5V
2	+5V
3	A_D-
4	B_D-
5	A_D+
6	B_D+
7	GND
8	GND
9	GND

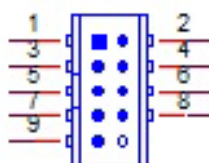

CN34	GPIO
Part Number	1653004099
Footprint	HD_5x2P_79_23N685B-10M10
Description	BOX HEADER 5x2P 2.00mm 180D(M) SMD 23N685B-10M10
Pin	Pin Name
1	+5V
2	GPIO4
3	GPIO0
4	GPIO5
5	GPIO1
6	GPIO6
7	GPIO2
8	GPIO7
9	GPIO3
10	GND

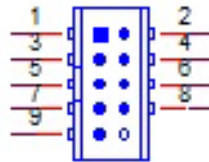

CN35	GPIO
Part Number	1653004099
Footprint	HD_5x2P_79_23N685B-10M10
Description	BOX HEADER 5x2P 2.00mm 180D(M) SMD 23N685B-10M10
Pin	Pin Name
1	+5V
2	GPIO4
3	GPIO0
4	GPIO5
5	GPIO1
6	GPIO6
7	GPIO2
8	GPIO7
9	GPIO3
10	GND

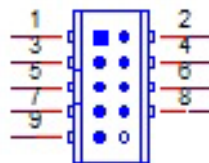

CN45	Front Panel
Part Number	1653004099
Footprint	HD_5x2P_79_23N685B-10M10
Description	BOX HEADER 5x2P 2.00mm 180D(M) SMD 23N685B-10M10
Pin	Pin Name
1	Power Button
2	Reset Button
3	GND
4	GND
5	PWR LED
6	CASEOPEN#
7	SATA LED+
8	SATA LED-
9	BUZZER+
10	BUZZER-

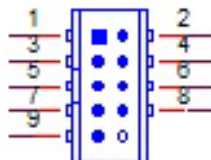

CN51	BIOS Debug
Part Number	1653000126
Footprint	HD_4x2P_50_H235
Description	PIN HEADER 2x4P 180D(M) 1.27mm SMD FTSH-104-01-F
Pin	Pin Name
1	CE#
2	+1.8VSB
3	SO
4	IO3
5	IO2
6	SCK
7	GND
8	SI

CN54	COM1/COM2
Part Number	1653004793
Footprint	HD_10x2P_79_23N685B-20M10
Description	BOX HEADER 10x2P 2.0mm 180D(M)SMD 23N685B-20M10B
Pin	Pin Name
1	DCD1#
2	DSR1#
3	RXD1
4	RTS1#
5	TXD1
6	CTS1#
7	DTR1#
8	RI1#
9	GND
10	GND
11	DCD2#
12	DSR2#
13	RXD2
14	RTS2#
15	TXD2
16	CTS2#
17	DTR2#
18	RI2#
19	GND
20	GND

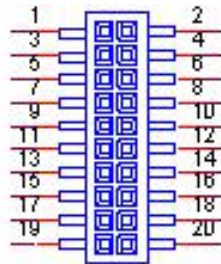

CN57	Inverter Power Output
Part Number	1655305220
Footprint	WF_5P_79_BOX
Description	WAFER BOX 2.0mm 5P 180D SMD(M) W/LOCK 0
Pin	Pin Name
1	+12V
2	GND
3	ENABKL
4	VBR
5	+5V

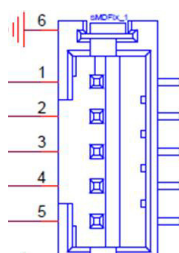

CN59	Fan
Part Number	1655302020
Footprint	WF_2P_79_BOX_R1_D
Description	WAFER BOX 2P 2.0mm 180D(M) DIP A2001WV2-2P
Pin	Pin Name
1	+12V
2	GND

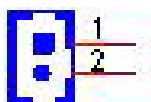

CN13	HDMI
Part Number	1654010746-01
Footprint	HDMI_19P_QJ3119C-WFB1-4F
Description	
Pin	Pin Name
1	TMDS Data2+
2	TMDS Data2 Shield
3	TMDS Data2-
4	TMDS Data1+
5	TMDS Data1 Shield
6	TMDS Data1-
7	TMDS Data0+
8	TMDS Data0 Shield
9	TMDS Data0-
10	TMDS Clock+
11	TMDS Clock Shield
12	TMDS Clock-
13	Reserved
14	Reserved
15	SCL
16	SDA
17	DDC Ground
18	+5V Power
19	Hot Plug Detect

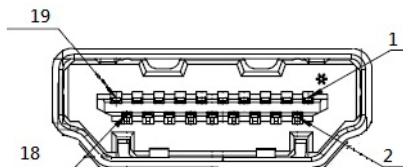

Appendix **B**

WDT & GPIO

B.1 Watchdog Timer Sample Code

Watchdog function:

The SCH3114 Runtime base I/O address is A00h
Setting WatchDog time value location at offset 66h
If set value "0", it is mean disable WatchDog function.

```
Superio_GPIO_Port = A00h
mov dx,Superio_GPIO_Port + 66h
mov al,00h
out dx,al
.model small
.486p
.stack 256
.data
SCH3114_IO EQU A00h
.code
org 100h
.STARTup
;=====
;47H
;enable WDT function bit [0]=0Ch
;=====
mov dx,SCH3114_IO + 47h
mov al,0Ch
out dx,al
;=====
;65H
;bit [1:0]=Reserved
;bit [6:2]Reserve=00000
;bit [7] WDT time-out Value Units Select
;Minutes=0 (default) Seconds=1
;=====
mov dx,SCH3114_IO + 65h;
mov al,080h
out dx,al
;=====
;66H
;WDT timer time-out value
;bit[7:0]=0~255
;=====
mov dx,SCH3114_IO + 66h
mov al,01h
out dx,al
;=====
;bit[0] status bit R/W
;WD timeout occurred =1;WD timer counting = 0
```

```

;=====
mov dx,SCH3114_IO + 68h
mov al,01h
out dx,al
.exit
END

```

B.2 GPIO Sample Code

The SCH3114 Runtime base I/O address is A00h

```

.model small
.486p
.stack 256
.data
SCH3114_IO EQU A00h
.code
org 100h
.STARTup
;=====
; Configuration GPIO as GPI or GPO by below register:
; GPIO0 = 23H, GPIO4 = 27H
; GPIO1 = 24H, GPIO5 = 29H
; GPIO2 = 25H, GPIO6 = 2AH
; GPIO3 = 26H, GPIO7 = 2BH
; Set 00H as output type, set 01H as input type
;=====
;=====
; Register 4BH configuration GPO value as high or low:
; 1 = HIGH
; 0 = LOW
;=====
mov dx,SCH3114_IO + 23h      ;GPIO 0
mov al,00h                  ;Set GPIO 0 as output type
out dx,al
mov dx,SCH3114_IO + 4Bh
mov al,01h                  ;Set GPIO 0 as high value.
out dx,al
.exit
END

```

Appendix **C**

System Assignments

C.1 System I/O Ports

Table C.1: System I/O Ports

Addr. Range (Hex)	Device
20–2D	Interrupt Controller
2E – 2F	Motherboard resources
30 – 3D	Interrupt Controller
40 – 43	System timer
4E – 4F	Motherboard resources
50 – 53	System timer
61 – 67	Motherboard resources
70 - 7F	System CMOS/real time clock
80 - 92	Motherboard resources
A0 – B1	Interrupt Controller
B2 – B3	Motherboard resources
B4 – BD	Interrupt Controller
2F8 – 2FF	COM2
3F8 – 3FF	COM1
400 – 47F	Motherboard resources
4D0 – 4D1	Interrupt Controller
500-AFF	Motherboard resources
F000-F03F	Intel® HD Graphics
F040-F05F	SM Bus Controller

C.2 1st MB Memory Map

Table C.2: 1st MB Memory Map

Addr. Range (Hex)	Device
80000000-90FFFFFF	Intel® HD Graphics
9141B000-9141BFFF	Intel® Trusted Execution Engine Interface
D0C00000-D0C7FFFF	Intel® Serial IO GPIO Host Controller
FED01000-FED1CFFF	Motherboard resources

C.3 Interrupt Assignments

Table C.3: Interrupt assignments

Interrupt#	Interrupt Source
NMI	Parity error detected
IRQ0	System timer
IRQ1	Using SERIRQ, Keyboard Emulation
IRQ2	Slave controller INTR output
IRQ3	Communications Port (COM2)
IRQ4	Communications Port (COM1)
IRQ5	Available
IRQ6	Available
IRQ7	Available
IRQ8	Internal RTC or HPET
IRQ9	Microsoft ACPI-Compliant System
IRQ10	Available
IRQ11	Available
IRQ12	Available
IRQ13	Numeric data processor
IRQ14	Intel® Serial IO GPIO Host Controller
IRQ15	Available

ADVANTECH

Enabling an Intelligent Planet

www.advantech.com

Please verify specifications before quoting. This guide is intended for reference purposes only.

All product specifications are subject to change without notice.

No part of this publication may be reproduced in any form or by any means, electronic, photocopying, recording or otherwise, without prior written permission of the publisher.

All brand and product names are trademarks or registered trademarks of their respective companies.

© Advantech Co., Ltd. 2019

Our company network supports you worldwide with offices in Germany, Austria, Switzerland, the UK and the USA. For more information please contact:

Headquarters

Germany



FORTEC Elektronik AG

Augsburger Str. 2b
82110 Germering

Phone: +49 89 894450-0
E-Mail: info@fortecag.de
Internet: www.fortecag.de

Fortec Group Members

Austria



Distec GmbH Office Vienna

Nuschinggasse 12
1230 Wien

Phone: +43 1 8673492-0
E-Mail: info@distec.de
Internet: www.distec.de

Germany



Distec GmbH

Augsburger Str. 2b
82110 Germering

Phone: +49 89 894363-0
E-Mail: info@distec.de
Internet: www.distec.de

Switzerland



ALTRAC AG

Bahnhofstraße 3
5436 Würenlos

Phone: +41 44 7446111
E-Mail: info@altrac.ch
Internet: www.altrac.ch

United Kingdom



Display Technology Ltd.

Osprey House, 1 Osprey Court
Hichingbrooke Business Park
Huntingdon, Cambridgeshire, PE29 6FN

Phone: +44 1480 411600
E-Mail: info@displaytechnology.co.uk
Internet: www.displaytechnology.co.uk

USA



Apollo Display Technologies, Corp.

87 Raynor Avenue,
Unit 1 Ronkonkoma,
NY 11779

Phone: +1 631 5804360
E-Mail: info@apolloDisplays.com
Internet: www.apolloDisplays.com