



OUR GLOBAL
COMPETENCE
CENTRES

 APOLLO DISPLAY
TECHNOLOGIES



 DISTEC



 DISPLAY
TECHNOLOGY



Manual

Advantech

MIO-2363

2,5" Single-Board Computer with Elkhart Lake Intel® Atom™ x6000E Series processor

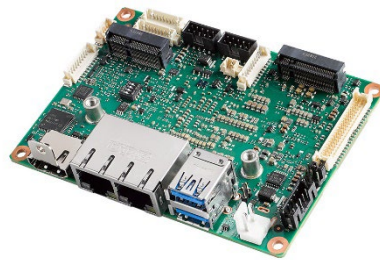

The information contained in this document has been carefully researched and is, to the best of our knowledge, accurate. However, we assume no liability for any product failures or damages, immediate or consequential, resulting from the use of the information provided herein. Our products are not intended for use in systems in which failures of product could result in personal injury. All trademarks mentioned herein are property of their respective owners. All specifications are subject to change without notice.



User Manual

MIO-2363

**Intel® Atom™ x6000E Series 2.5"
PICO-ITX SBC**

ADVANTECH

Enabling an Intelligent Planet

Copyright

The documentation and the software included with this product are copyrighted 2022 by Advantech Co., Ltd. All rights are reserved. Advantech Co., Ltd. reserves the right to make improvements in the products described in this manual at any time without notice. No part of this manual may be reproduced, copied, translated, or transmitted in any form or by any means without the prior written permission of Advantech Co., Ltd. The information provided in this manual is intended to be accurate and reliable. However, Advantech Co., Ltd. assumes no responsibility for its use, nor for any infringements of the rights of third parties that may result from its use.

Acknowledgments

Intel[®] is a trademark of Intel[®] Corporation.

AMI is a trademark of American Megatrends, Inc.

IBM, PC, PS/2 and VGA are trademarks of International Business Machines Corporation.

Microsoft Windows[®], DirectX[®] is a registered trademark of Microsoft Corp.

All other product names or trademarks are properties of their respective owners.

For more information on this and other Advantech products, please visit our websites at:

<http://www.advantech.com> <http://www.advantech.com/eplatform>

For technical support and service, please visit our support website at:

<http://support.advantech.com/>

This manual is for the MIO-2363.

Product Warranty (2 years)

Advantech warrants the original purchaser that each of its products will be free from defects in materials and workmanship for two years from the date of purchase.

This warranty does not apply to any products that have been repaired or altered by persons other than repair personnel authorized by Advantech, or products that have been subject to misuse, abuse, accident, or improper installation. Advantech assumes no liability under the terms of this warranty as a consequence of such events.

Because of Advantech's high quality-control standards and rigorous testing, most customers never need to use our repair service. If an Advantech product is defective, it will be repaired or replaced free of charge during the warranty period. For out-of-warranty repairs, customers will be billed according to the cost of replacement materials, service time, and freight. Please consult your dealer for more details.

If you believe your product to be defective, follow the steps outlined below.

1. Collect all the information about the problem encountered. (For example, CPU speed, Advantech products used, other hardware and software used, etc.) Note anything abnormal and list any onscreen messages displayed when the problem occurs.
2. Call your dealer and describe the problem. Please have your manual, product, and any helpful information readily available.
3. If your product is diagnosed as defective, obtain a return merchandise authorization (RMA) number from your dealer. This allows us to process your return more quickly.
4. Carefully pack the defective product, a completed Repair and Replacement Order Card, and a proof of purchase date (such as a photocopy of your sales receipt) into a shippable container. Products returned without a proof of purchase date are not eligible for warranty service.
5. Write the RMA number clearly on the outside of the package and ship the package prepaid to your dealer.

Declaration of Conformity

CE

This product has passed the CE test for environmental specifications when shielded cables are used for external wiring. We recommend the use of shielded cables. This type of cable is available from Advantech. Please contact your local supplier for ordering information.

Test conditions for passing also include the equipment being operated within an industrial enclosure. In order to protect the product from damage caused by electrostatic discharge (ESD) and EMI leakage, we strongly recommend the use of CE-compliant industrial enclosure products.

FCC Class B

This equipment has been tested and found to comply with the limits for a Class B digital device, pursuant to part 15 of the FCC Rules. These limits are designed to provide reasonable protection against harmful interference in a residential installation. This equipment generates, uses, and can radiate radio frequency energy and, if not installed and used in accordance with the instruction manual, may cause harmful interference to radio communications. However, there is no guarantee that interference will not occur in a particular installation. If this equipment does cause harmful interference to radio or television reception, which can be determined by turning the equipment off and on, the user is encouraged to try to correct the interference by one or more of the following measures:

- Reorient or relocate the receiving antenna.
- Increase the separation between the equipment and receiver.
- Connect the equipment into an outlet on a circuit different from that to which the receiver is connected.
- Consult the dealer or an experienced radio/TV technician for assistance.

Technical Support and Assistance

1. Visit the Advantech website at www.advantech.com/support to obtain the latest product information.
2. Contact your distributor, sales representative, or Advantech's customer service center for technical support if you need additional assistance. Please have the following information ready before calling:
 - Product name and serial number
 - Description of your peripheral attachments
 - Description of your software (operating system, version, application software, etc.)
 - A complete description of the problem
 - The exact wording of any error messages

Packing List

Before system installation, check that the items listed below are included and in good condition. If any item does not accord with the list, contact your dealer immediately.

- 1 x MIO-2363 SBC
- 1 x USB cable 20cm (p/n: 1700030406-01)
- 2 x COM port cable 20cm (p/n: 1700030404-01)
- 1 x Audio cable 20cm (p/n: 1700019584-01)
- 1 x ATX power cable 20cm (p/n: 1700019705-01)
- 1 x Passive heatsink (p/n: 1970005240T001)
- Standoff
- 1 x Startup manual
- 1 x DeviceOn package

Contents

Chapter 1	Introduction.....	1
1.1	Introduction	2
1.2	Specifications.....	2
1.3	Block Diagram.....	4
Chapter 2	Mechanical Specifications.....	5
2.1	Introduction	6
2.2	Board Layout: Dimensions	6
	Figure 2.1 MIO-2363 Mechanical Diagram (Top Side).....	6
	Figure 2.2 MIO-2363 Mechanical Diagram (Bottom Side).....	6
	Figure 2.3 MIO-2363 Mechanical Diagram (Coastline)	7
	Figure 2.4 MIO-2363 Mechanical Diagram (with Heatsink).....	7
2.3	Quick Installation Guide	8
2.3.1	Heatsink	8
	Figure 2.5 MIO-2363 Heatsink Installation	8
	Figure 2.6 MIO-2363 Heatsink Installation	8
Chapter 3	Installation.....	9
3.1	Jumper & Switches	10
	Table 3.1: Jumpers and Switches	10
3.2	Connectors.....	10
	Table 3.2: Connectors	10
3.3	Locating Connectors	11
	Figure 3.1 MIO-2363 Connector Locations (Bottom Side).....	11
3.4	Setting Jumpers	11
3.4.1	Miscellaneous Switch (SW1)	12
3.4.2	Panel Voltage Selection (VDD1).....	12
3.4.3	DC Power Input Connector (CN7)	13
3.4.4	Audio Internal Connector: AUDIO1.....	13
3.4.5	USB2.0 Internal Connector: USB2.....	14
3.4.6	LVDS Connector (LVDS1)	14
3.4.7	Panel Inverter Connector (BL1)	16
3.4.8	COM Port Internal Connector 1 (COM1).....	16
3.4.9	COM Port Internal Connector 2 (COM2).....	17
3.4.10	GPIO Internal Connector (GPIO1).....	17
3.4.11	I2C Internal Connector (CN1)	18
3.4.12	Front Panel Internal Connector (CN5)	18
3.4.13	M.2 Key-E Connector (M2_1)	19
3.4.14	M.2 Key-B Connector (M2_2)	21
3.4.15	RTC Battery Connector (BAT1)	23
Chapter 4	AMI BIOS Setup	25
4.1	Entering Setup	26
4.1.1	Advanced BIOS Features Setup.....	27
4.1.2	Chipset Configuration	50
4.1.3	Security	62
4.1.4	Boot.....	63
4.1.5	Save & Exit	64

Appendix A	System I/O Ports	65
A.1	System I/O Ports.....	66
A.2	DMA Channel Assignments	66
A.3	1st MB Memory Map.....	67
A.4	Interrupt Assignments	67

Chapter 1

Introduction

1.1 Introduction

Advantech MIO-2363 is a 2.5" PICO-ITX form factor SBC (compact series, 100 x 72 mm; 3.9 x 2.8 in), powered by Intel® Atom® x6000E series. It provides embedded iManager 3.0, SUSI 4.0, and Advantech's WISE-DeviceOn to monitor and control system operation effectively and remotely. MIO-2363 possess onboard LPDDR4x-3733 and eMMC5.1 up to 128GB.

1.2 Specifications

Platform	Processor	x6211E	x6413E	x6425E
	Max. Frequency	3.0GHz	3.0GHz	3.0GHz
	Base Frequency	1.3GHz	1.5GHz	2.0GHz
	Core/Thread	2/2	4/4	4/4
	L2 Cache	1.5MB	1.5MB	1.5MB
	CPU TDP	6W	9W	12W
	Chipset	Intel® Chipset (SoC Integrated)		
	BIOS	AMI UEFI 256Mbit		
Memory	Technology	LPDDR4x 3200	LPDDR4x 3200	LPDDR4x 3733
	Max. Capacity	4GB	4GB	8GB
	Channel/Socket	Dual Channels/Onboard		
	ECC Support	IBECC	IBECC	IBECC
Storage	eMMC	64GB	64GB	128GB
Graphics	Controller	Intel UHD Graphics for 10th Gen Intel Processor		
	Max. Frequency	750MHz	750MHz	750MHz
	Base Frequency	350MHz	500MHz	500MHz
	3D/HW Acceleration	DX12, OGL4.5, OCL1.2, Vulkan 1.1; HW encode HEVC/H.265, MPEG2, JPEG/MJPEG		
Display I/F	LCD	LVDS Dual Channel 18/24-bit LVDS		
	HDMI	Up to 2160 x 3840 @30Hz		
	Multiple Display	LVDS+HDMI		
Ethernet	Controller	2 x RJ-45, LAN1: Intel i210, LAN2: Intel i210		
	Speed	10/100/1000 Mbps		
External I/O	Ethernet	2 x RJ-45		
	VGA/HDMI/DP	-/1/-		
	USB3.2/USB2.0	2/-		
	Power DC-Jack	Optional		

Internal I/O	SATA	-		
	USB2.0	2		
	Serial Bus	1x I2C		
	COM Port	2 x RS-232/422/485		
	GPIO	8-bit general purpose input output I/O		
	Audio	Realtek ALC888, Line-in/Line-out/MIC		
	Inverter	3.3V/5V/12V		
	LPC/SPI Bus	eSPI for EIO-211/ SPI for TPM/no LPC		
	Front Panel Control	Power-on, Reset, Buzzer, SATA LED, CaseOpen		
Board Feature	Watchdog Timer	Programmable 1 ~ 65535 sec/min		
	TPM	TPM2.0 (Infineon SLB9670)		
	iManager 3.0	SW API for Hardware Monitor, Smart Fan Control, Brightness Control, I2C, GPIO, WDT		
Expansion	M.2	1x M.2 E-Key for 2230 module (PCIex1, USB 2.0 to support wireless module) 1x M.2 B-Key for 2242 module (SATA, USB 2.0 to support SATA storage; BOM option to PCIex1 to support PCIe storage or RS-232 module)		
Power	Supply Voltage	Vin: DC 12~24V +/- 10%; RTC Battery: Lithium 3V/ 210mAH		
	Connector	2pin Power Connector (180D); Optional: DC-IN Jack		
	Power Management	AT, ATX		
	Max. Consumption	TBU	TBU	26.69W (12V); 28.7W (24V)
	Idle Consumption	TBU	TBU	9.35W (12V); 11.6W (24V)
Environment	Temperature	Operating: Standard: 0 ~ 60° C (32 ~ 140° F),		
		Operating Extend: -40 ~ 85° C (-40 ~ 185° F)		
		Storage: -40 ~ 85° C (-40 ~ 185° F)		
	Humidity	Operating: 40° C @ 95% relative humidity, non-condensing		
Storage: 60° C @ 95%relative humidity, non-condensing				
Vibration Resistance	3.5 Grms			
Certification	EMC	CE, FCC Class B		
Mechanical	Dimensions	100 x 72 mm (3.9" x 2.8")		
	Net Weight	86g		

1.3 Block Diagram

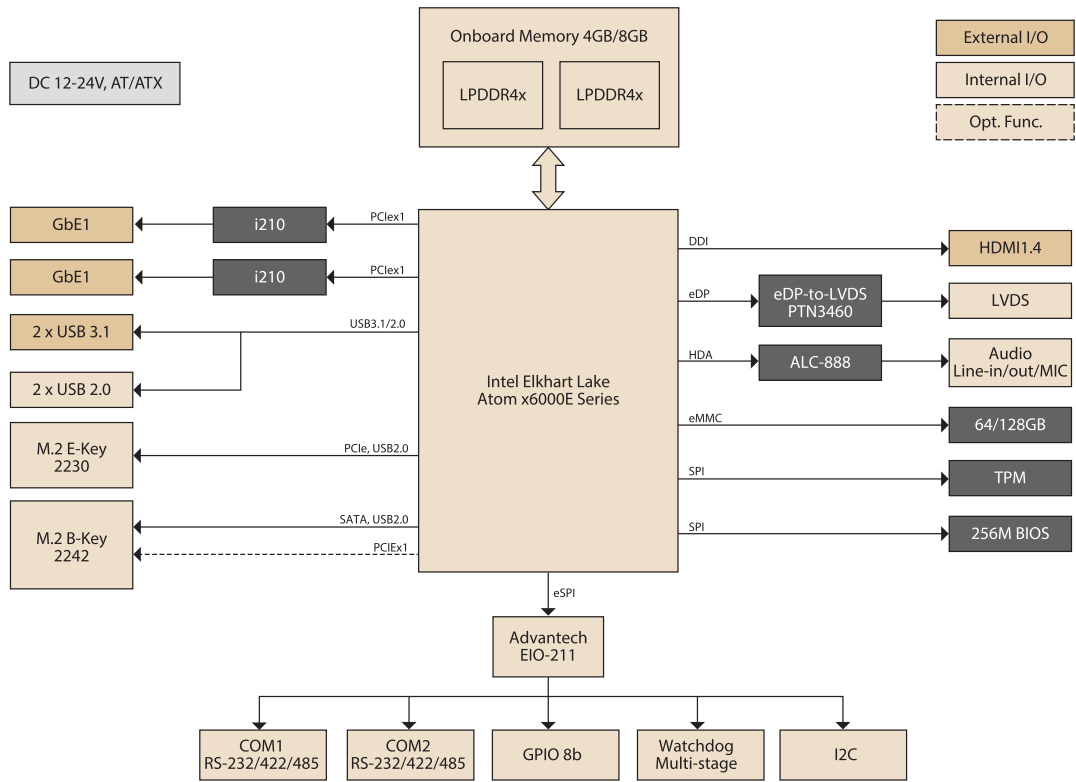

Chapter 2

Mechanical Specifications

2.1 Introduction

The MI/O compact form factor SBC is a new-generation SBC designed with a variety of mechanical improvements. This chapter includes board dimension and assembly instructions for the standard thermal solution.

2.2 Board Layout: Dimensions

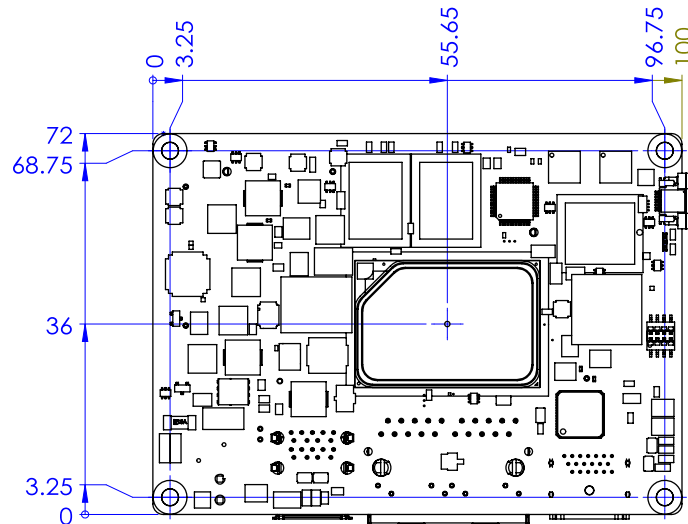

Figure 2.1 MIO-2363 Mechanical Diagram (Top Side)

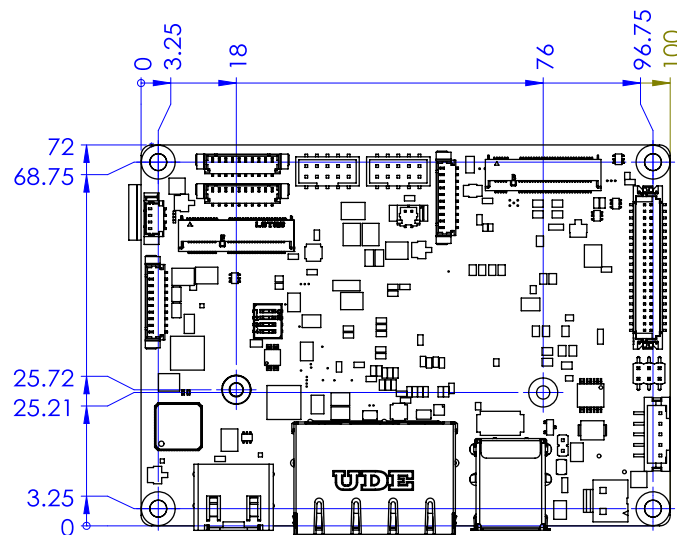

Figure 2.2 MIO-2363 Mechanical Diagram (Bottom Side)

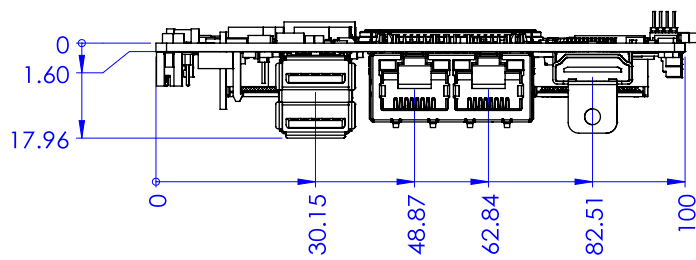

Figure 2.3 MIO-2363 Mechanical Diagram (Coastline)

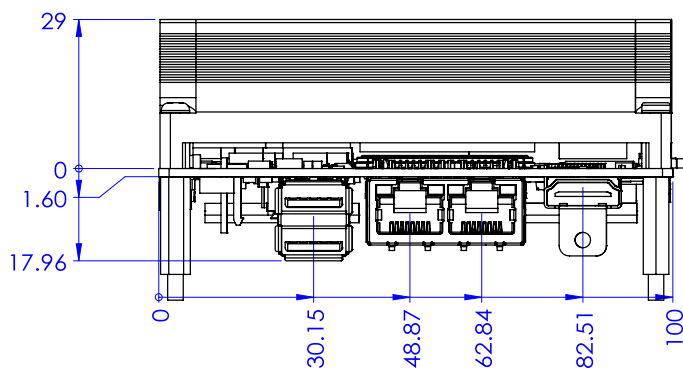

Figure 2.4 MIO-2363 Mechanical Diagram (with Heatsink)

2.3 Quick Installation Guide

This section introduces installation of the heatsink, which contains in the white box inside the package. Please assemble it by following diagram. Remember to remove the plastic from thermal pad before assembling.

2.3.1 Heatsink

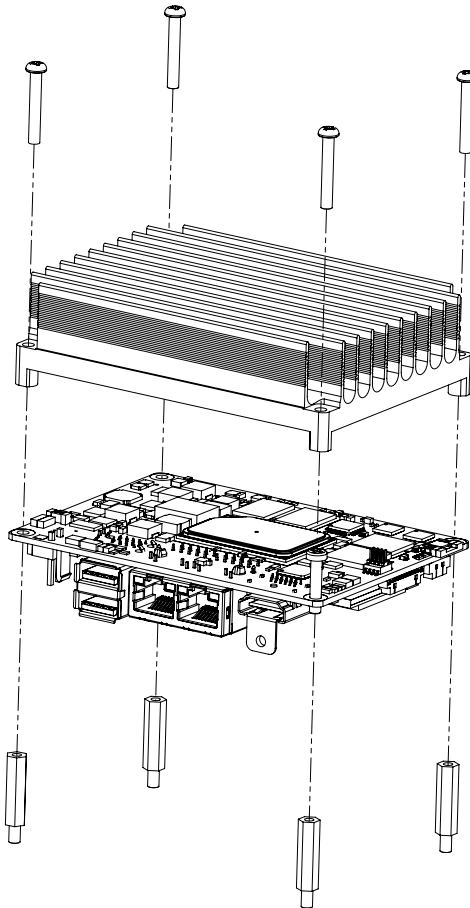

Figure 2.5 MIO-2363 Heatsink Installation

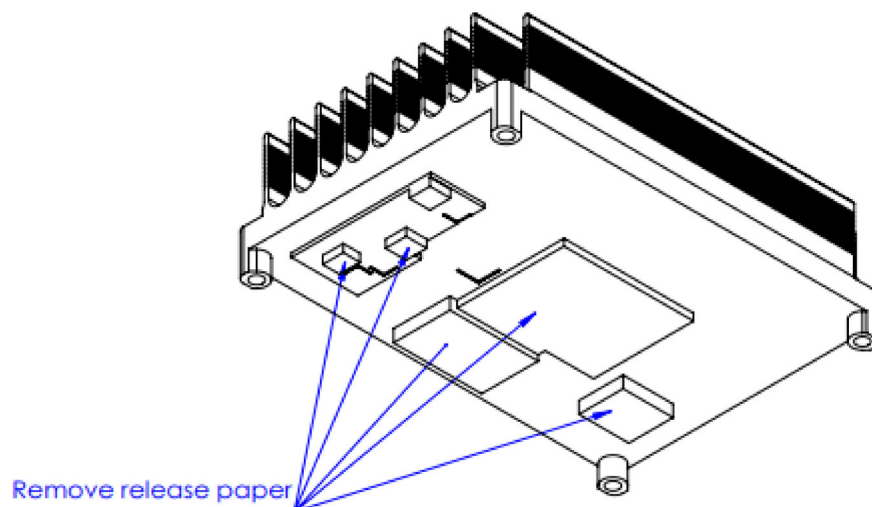

Figure 2.6 MIO-2363 Heatsink Installation

Chapter 3

Installation

3.1 Jumper & Switches

Table 3.1: Jumpers and Switches

VDD1	Panel Voltage Selection Jumper
SW1	Miscellaneous Switch

3.2 Connectors

Table 3.2: Connectors

Label	Function
CN1	I ² C Internal Connector
CN5	Front Panel Internal Connector
CN7	DC Power Input Connector
COM1	COM Port Internal Connector 1
COM2	COM Port Internal Connector 2
USB1	USB3.2 Connector
USB2	USB2.0 Internal Connector
LAN1	Dual RJ45 LAN Ports
HDMI1	HDMI Connector
GPIO1	GPIO Internal Connector
M2_1	M.2 Key-E Connector
M2_2	M.2 Key-B Connector
AUDIO1	Audio Internal Connector
BAT1	RTC battery Connector
LVDS1	LVDS Connector
BL1	Panel Inverter Connector

3.3 Locating Connectors

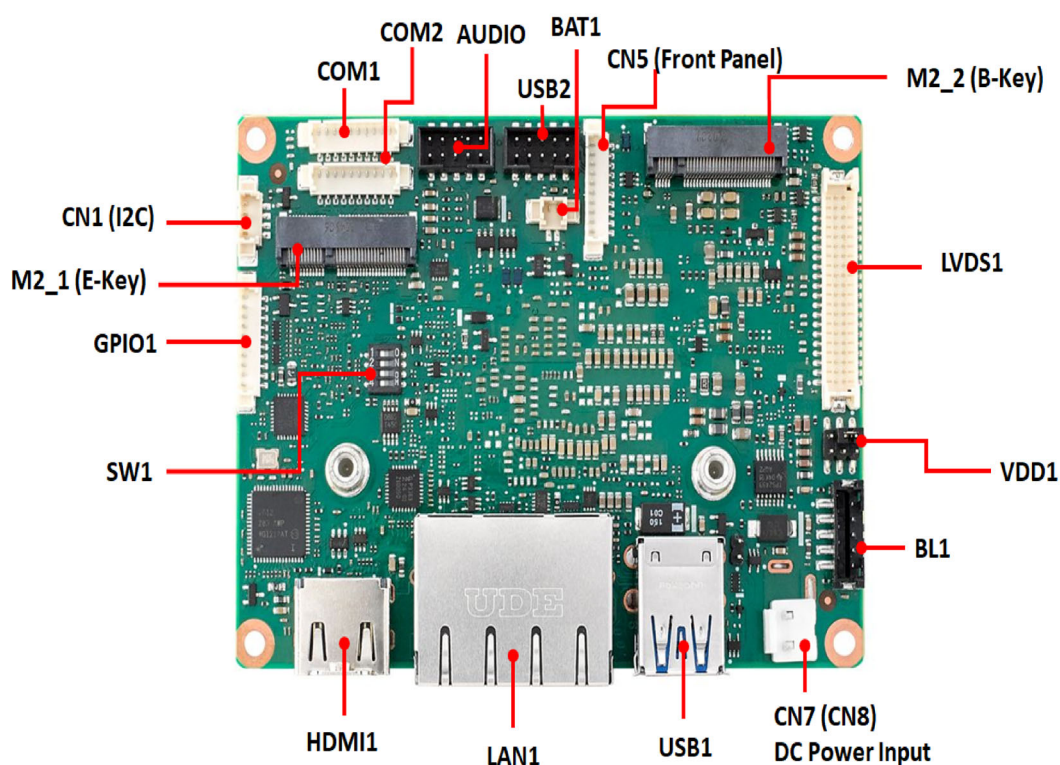
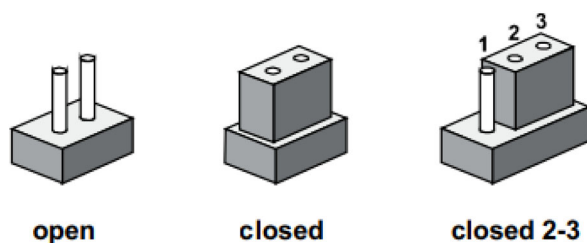

Figure 3.1 MIO-2363 Connector Locations (Bottom Side)

3.4 Setting Jumpers

You may configure your card to match the needs of your application by setting jumpers. A jumper is a metal bridge used to close an electric circuit. It consists of two metal pins and a small metal clip (often protected by a plastic cover) that slides over the pins to connect them. To “close” a jumper, you connect the pins with the clip. To “open” a jumper, you remove the clip. Sometimes a jumper will have three pins, labeled 1, 2, and 3. In this case you would connect either pins 1 and 2, or 2 and 3. The jumper settings are schematically depicted in this manual as follows:



A pair of needle-nose pliers may be helpful when working with jumpers. If you have any doubts about the best hardware configuration for your application, contact your local distributor or sales representative before you make any changes. Generally, you simply need a standard cable to make most connections.

3.4.1 Miscellaneous Switch (SW1)



Part Number	1600000084
Description	SLIDE SW CHS-04TA (29) SMD 8P 6.6x5.4x2.4mm
Setting	Function
1	ON: AT mode (Default) OFF: ATX mode
2	Reserved
3	OFF: Normal (Default) ON: Load BIOS Default
4	ON: Top Swap Override ENABLE OFF: Top Swap Override DISABLE

3.4.2 Panel Voltage Selection (VDD1)



Part Number	1653003260
Description	PIN HEADER 3x2P 2.0mm 180D(M) SMD 21N22050
Jumper Short	Panel Voltage
1-3	3.3V (Default)
3-5	5V
3-4	12V

3.4.3 DC Power Input Connector (CN7)

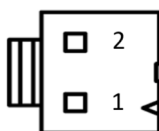

Part Number	1655003962
Description	WAFER 2P 3.96mm 180D(M) DIP A3963WV2-2P
Pin	Signal Pin Definition
1	GND
2	+V24_V12_DC_IN

3.4.4 Audio Internal Connector: AUDIO1

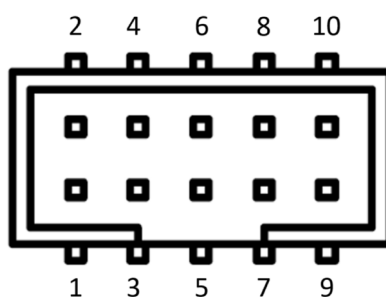

Part Number	1653008214-01
Description	BH 2x5P/2.0/PA6T/G-FL/VA(M)/S/BK/H6.05/C+R
Pin	Signal Pin Definition
1	LOUTR
2	LINR
3	GND
4	GND
5	LOUTL
6	LINL
7	GND
8	FRONT-JD
9	MIC1R
10	MIC1L

3.4.5 USB2.0 Internal Connector: USB2

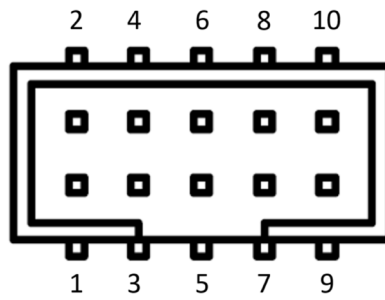

Part Number	1653008214-01
Description	BH 2x5P/2.0/PA6T/G-FL/VA(M)/S/BK/H6.05/C+R
Pin	Signal Pin Definition
1	+USBV3
2	+USBV3
3	USB2_D6-
4	USB2_D5-
5	USB2_D6+
6	USB2_D5+
7	GND
8	GND
9	NC
10	NC

3.4.6 LVDS Connector (LVDS1)

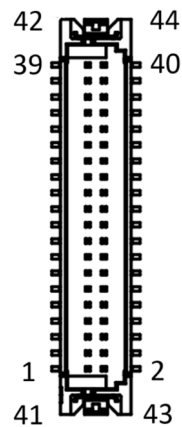

Part Number	1653008443-01
Description	Wafer 2x20P/1.25/PA9T/VA(M)/GFL/S/WH/H4.8/W P
Pin	Signal Pin Definition
1	+V_LCD
2	+V_LCD
3	GND
4	GND
5	+V_LCD
6	+V_LCD
7	LVDS1_0_D0-
8	LVDS1_1_D0-
9	LVDS1_0_D0+
10	LVDS1_1_D0+
11	GND
12	GND
13	LVDS1_0_D1-
14	LVDS1_1_D1-
15	LVDS1_0_D1+
16	LVDS1_1_D1+
17	GND
18	GND
19	LVDS1_0_D2-
20	LVDS1_1_D2-
21	LVDS1_0_D2+
22	LVDS1_1_D2+
23	GND
24	GND
25	LVDS1_0_CLK-
26	LVDS1_1_CLK-
27	LVDS1_0_CLK+
28	LVDS1_1_CLK+
29	GND
30	GND
31	LVDS0_DDCCLK_AUX+
32	LVDS0_DDCCLK_AUX-
33	GND
34	GND
35	LVDS1_0_D3-
36	LVDS1_1_D3-
37	LVDS1_0_D3+
38	LVDS1_1_D3+
39	NC
40	LVDS1_VCON
41	NC
42	NC
43	NC
44	NC

3.4.7 Panel Inverter Connector (BL1)



Part Number	1653007905-01
Description	Wafer 1X5P/2.0mm/VA/Sn/BK/S/H6.5/C+R
Pin	Signal Pin Definition
1	+V12_1_INVERTER_0
2	GND
3	LVDS1_z_ENABKL
4	EC_LVDS1_z_PWM
5	+V5_1_INVERTER_0

3.4.8 COM Port Internal Connector 1 (COM1)

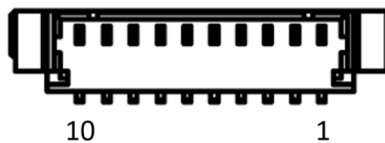

Part Number	1653007728-01
Description	Wafer 1x10P/1.25mm/PA/M/VA/WH/Sn/H4.7mm/WO CAP
Pin	Signal Pin Definition
1	NC
2	COM1_RI#
3	COM1_DTR#
4	COM1_CTS#
5	COM1_TXD
6	COM1_RTS#
7	COM1_RXD
8	COM1_DSR#
9	COM1_DCD#
10	GND

3.4.9 COM Port Internal Connector 2 (COM2)

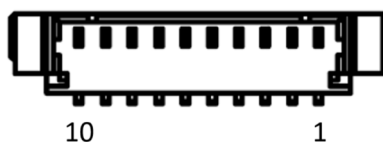

Part Number	1653007728-01
Description	Wafer 1x10P/1.25mm/PA/M/VA/WH/Sn/H4.7mm/WO CAP
Pin	Signal Pin Definition
1	NC
2	COM2_RI#
3	COM2_DTR#
4	COM2_CTS#
5	COM2_TXD
6	COM2_RTS#
7	COM2_RXD
8	COM2_DSR#
9	COM2_DCD#
10	GND

3.4.10 GPIO Internal Connector (GPIO1)

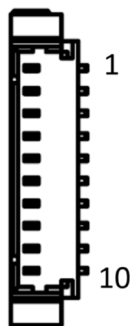

Part Number	1653007728-01
Description	Wafer1x10P/1.25mm/PA/M/VA/WH/Sn/H4.7mm/WO CAP
Pin	Signal Pin Definition
1	GND
2	EC_P1_GPIO7
3	EC_P1_GPIO2
4	EC_P1_GPIO6
5	EC_P1_GPIO1
6	EC_P1_GPIO5
7	EC_P1_GPIO0
8	EC_P1_GPIO4
9	+V5A_GPIO
10	EC_P1_GPIO3

3.4.11 I2C Internal Connector (CN1)

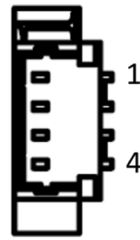

Part Number	1655904020
Description	WAFER 4P 1.25mm 180D(M) SMD 85205-04001
Pin	Signal Pin Definition
1	GND
2	EC_I2C0_z_DAT
3	EC_I2C0_z_CLK
4	+V5_I2CCONN

3.4.12 Front Panel Internal Connector (CN5)

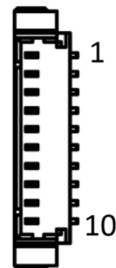

Part Number	1653007728-01
Description	cWafer 1x10P/1.25mm/PA/M/VA/WH/Sn/H4.7mm/WO CAP
Pin	Signal Pin Definition
1	GND
2	BUZZER-
3	BUZZER+
4	RDC_CASEOPEN
5	FP_HDD_a_LED#
6	FP_a_PSIN#
7	FP_a_RST#
8	+V3.3
9	NC
10	+V5

3.4.13 M.2 Key-E Connector (M2_1)

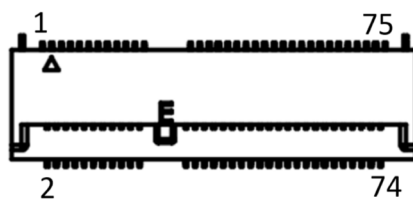

Part Number	1654012663-01
Description	NGFF 75P/0.5mm/(F)/LCP/RA/GFL/S/BK/H8.5mm/E-k
Pin	Signal Pin Definition
1	GND
2	+V3.3SB_M.2_E
3	USB2_z_P9+
4	+V3.3SB_M.2_E
5	USB2_z_P9-
6	NC
7	GND
8	NC
9	NC
10	NC
11	NC
12	NC
13	NC
14	NC
15	NC
16	NC
17	NC
18	GND
19	NC
20	NC
21	NC
22	NC
23	NC
32	NC
33	GND
34	NC
35	M2E1_PCIE_TX+
36	NC
37	M2E1_PCIE_TX-
38	NC
39	GND
40	NC
41	PCIE4_RX+
42	NC
43	PCIE4_RX-

44	NC
45	GND
46	NC
47	CLK_M2E_z_PCIE+
48	NC
49	CLK_M2E_z_PCIE-
50	M2E1_SUSCLK
51	GND
52	PLTRST_BUF#
53	PCIE_a_CLKREQ#
54	BT_DISABLE#
55	PCIE_WAKE#
56	WIFI_DISABLE#
57	GND
58	NC
59	NC
60	NC
61	NC
62	NC
63	GND
64	NC
65	NC
66	NC
67	NC
68	NC
69	GND
70	NC
71	NC
72	+V3.3SB_M.2_E
73	NC
74	+V3.3SB_M.2_E
75	GND
H1	NC
H2	NC
H3	GND
H4	GND

3.4.14 M.2 Key-B Connector (M2_2)

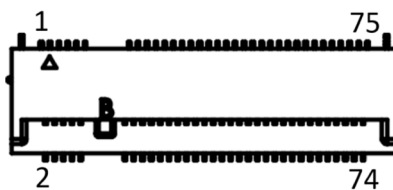

Part Number	1654012087-02
Description	NGFF 75P/0.5mm/(F)/LCP/RA/GFL/S/BK/H8.50/B-key
Pin	Signal Pin Definition
1	+3.3V
2	+V3.3SB_M.2_B
3	GND
4	+V3.3SB_M.2_B
5	GND
6	+V1.8_DUAL
7	USB2_a_P4+
8	+V3.3SB_M.2_B
9	USB2_a_P4-
10	NC
11	GND
20	NC
21	+V3.3SB
22	NC
23	NC
24	NC
25	+V1.8_DUAL
26	NC
27	GND
28	NC
29	NC
30	NC
31	NC
32	NC
33	GND
34	NC
35	NC
36	NC
37	NC
38	NC
39	GND
40	NC
41	SATA_PCIE_C_RX+
42	NC
43	SATA_PCIE_C_RX-

44	NC
45	GND
46	NC
47	SATA_PCIE_C_TX-
48	NC
49	SATA_PCIE_C_TX+
50	PLTRST_BUF#_M2B1
51	GND
52	PCIE_a_CLKREQ2#
53	CLK100M_M2B1_R_D2-
54	PCIE_WAKE#_M2B1
55	CLK100M_M2B1_R_D2+
56	NC
57	GND
58	NC
59	NC
60	NC
61	NC
62	NC
63	NC
64	NC
65	NC
66	NC
67	M2B1_RESET#_R
68	M2B1_SUSCLK
69	+V3.3SB
70	+V3.3SB_M.2_B
71	GND
72	+V3.3SB_M.2_B
73	GND
74	+V3.3SB_M.2_B
75	+V3.3SB
H1	NC
H2	NC
H3	GND
H4	NC

3.4.15 RTC Battery Connector (BAT1)

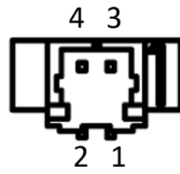

Part Number	1655902000
Description	WAFER 2P 1.25mm 180D(M) SMD 85205-02001
Pin	Signal Pin Definition
1	+VBAT_R
2	GND

Chapter 4

AMI BIOS Setup

With the AMIBIOS Setup program, you can modify BIOS settings and control the various system features. This chapter describes the basic navigation of the MIO-5152 BIOS setup screens.



AMI's BIOS ROM has a built-in setup program that allows users to modify the basic system configuration. This information is stored in battery-backed CMOS so it retains the Setup information when the power is turned off.

4.1 Entering Setup

Turn on the computer and check for the patch code. If there is a number assigned to the patch code, it means that the BIOS supports your CPU. If there is no number assigned to the patch code, please contact an Advantech application engineer to obtain an up-to-date patch code file. This will ensure that your CPU's system status is valid. After ensuring that you have a number assigned to the patch code, press and you will immediately be allowed to enter Setup.

When you first enter the BIOS Setup Utility, you will encounter the Main setup screen. You can always return to the Main setup screen by selecting the Main tab. There are two Main Setup options. They are described in this section. The Main BIOS Setup screen is shown below.



The Main BIOS setup screen has two main frames. The left frame displays all the options that can be configured. Grayed-out options cannot be configured; options in blue can. The right frame displays the key legend.

Above the key legend is an area reserved for a text message. When an option is selected in the left frame, it is highlighted in white. Often a text message will accompany it.

- **System time/System date**

Use this option to change the system time and date. Highlight System Time or System Date using the <Arrow> keys. Enter new values through the keyboard. Press the <Tab> key or the <Arrow> keys to move between fields. The date must be entered in MM/DD/YY format. The time must be entered in HH:MM:SS format.

4.1.1 Advanced BIOS Features Setup

Select the Advanced tab from the MIO-2363 setup screen to enter the Advanced BIOS Setup screen. You can select any of the items in the left frame of the screen, such as CPU Configuration, to go to the sub menu for that item. You can display an Advanced BIOS Setup option by highlighting it using the <Arrow> keys. All Advanced BIOS Setup options are described in this section. The Advanced BIOS Setup screens is shown below. The sub menus are described on the following pages.

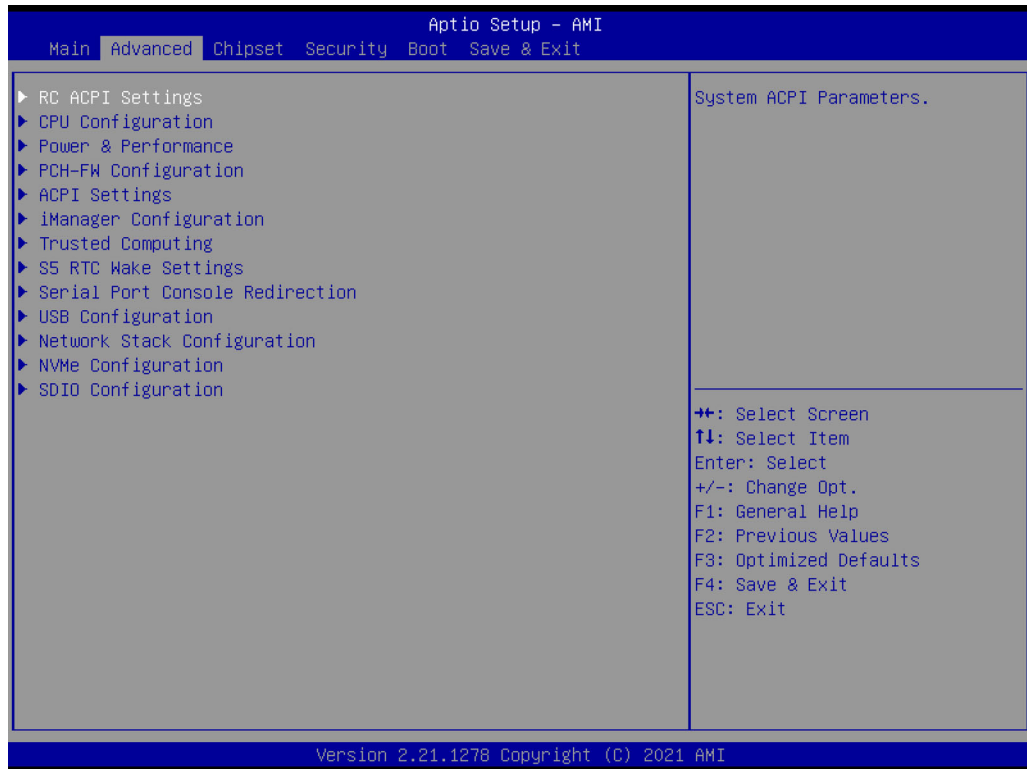

4.1.1.1 RC ACPI Settings

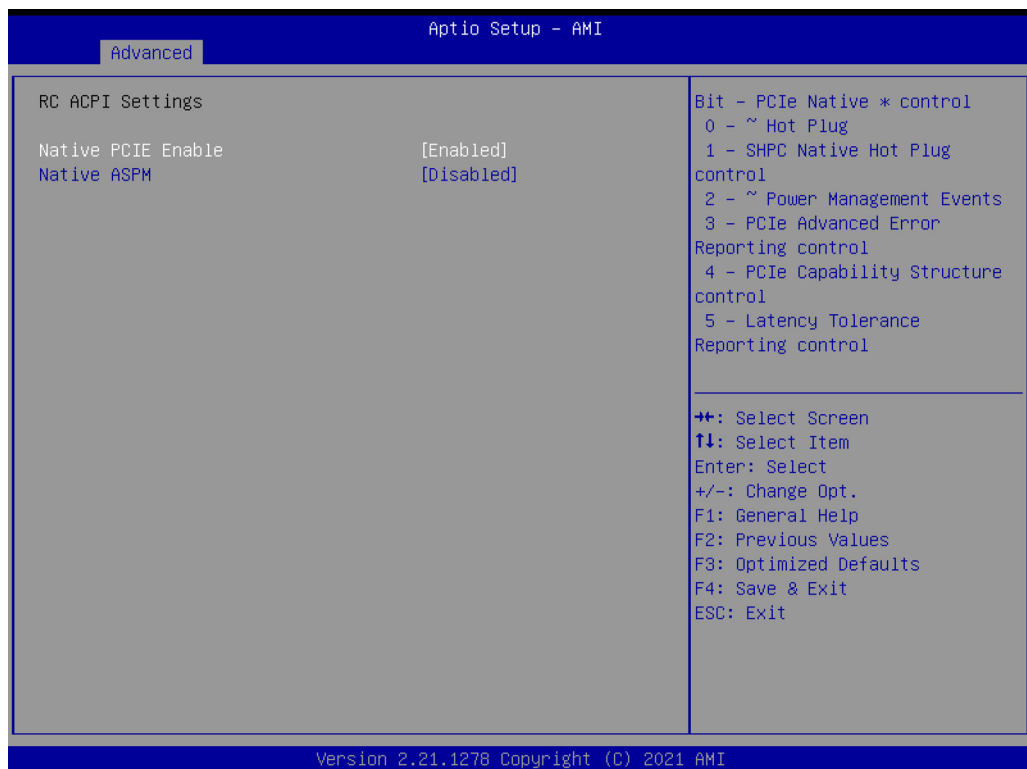

- **Native PCIE Enable**
Enable/Disable PCIE Native Control reported in ACPI Table.
- **Native ASPM**
Choose ASPM feature is controlled by OS or BIOS.

4.1.1.2 CPU Configuration



- **CPU Flex Ratio Override**
Enable/Disable CPU Flex Ratio Programming.
- **Hardware Prefetcher**
This item allows users to enable or disable the hardware prefetcher feature.
- **Adjacent Cache Line Prefetch**
This item allows users to enable or disable the adjacent cache line prefetch feature.
- **Intel (VMX) Virtualization Technology**
When Enabled, a VMM can utilize the additional hardware capability provided by Vanderpool Technology.
- **Active Processor Cores**
This item allows users to set how many processor cores should be active.
- **AP threads Idle Manner**
AP threads Idle Manner for waiting signal to run.
- **AES**
Enable/Disable AES (Advanced Encryption Standard).
- **MachineCheck**
Enable/Disable Machine Check.
- **MonitorMWait**
Enable/Disable MonitorMWait.

4.1.1.3 Power & Performance



- **CPU – Power Management Control**
CPU – Power Management Control Options.
- **GT – Power Management Control**
GT – Power Management Control Options.

Power Management Control

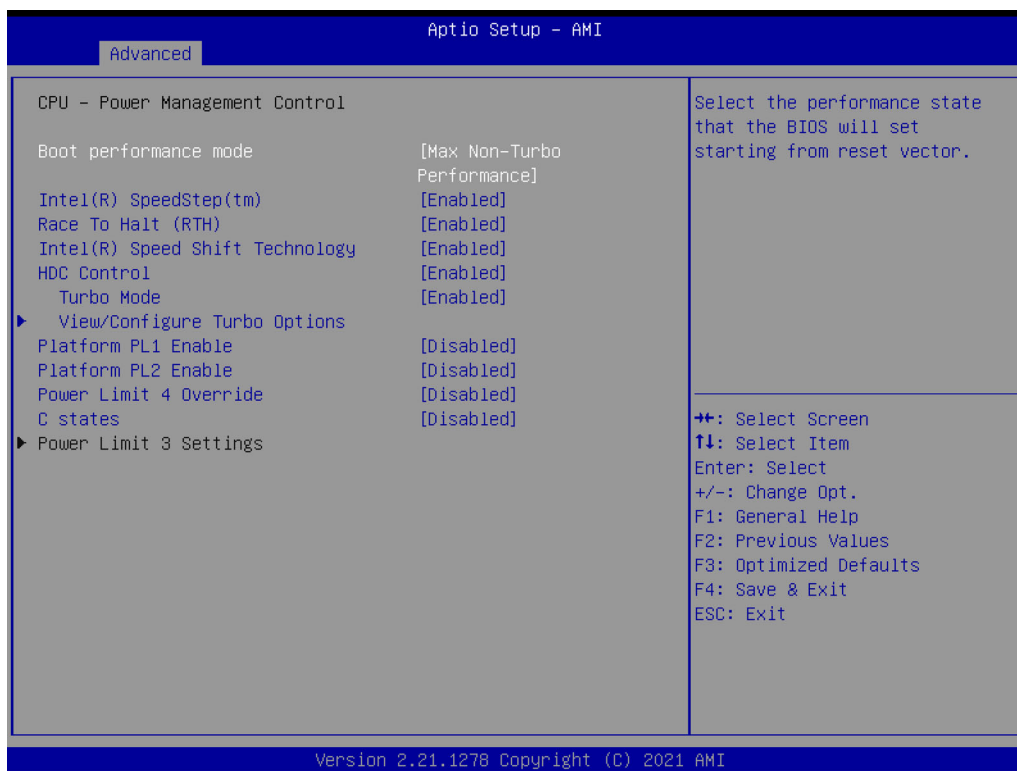

- **Boot Performance mode**
Select the performance state that the BIOS will set before OS handoff.
- **Intel® SpeedStep™**
Allows more than two frequency ranges to be supported.
- **Race to Halt (RTH)**
Enable/Disable Race to Halt feature. RTH will dynamically increase CPU frequency in order to enter pkg C-State faster to reduce overall power.
- **Intel® Speed Shift Technology**
Enable/Disable Intel® Speed Shift Technology support.
- **HDC Control**
Enable/Disable Intel HDC.
- **Turbo Mode**
Enable/Disable processor turbo mode.
- **View/Configure Turbo Options**
View and Configure Turbo Options.
- **Platform PL1 Enable**
Enable/Disable Platform Power Limit 1 programming.
- **Platform PL2 Enable**
Enable/Disable Platform Power Limit 1 programming.
- **Power Limit 4 Override**
Enable/Disable Power Limit 4 override.
- **C states**
Enable/Disable CPU power management.
- **PowerLimit 3 Settings**
Power Limit 3 settings.

View/Configure Turbo Options

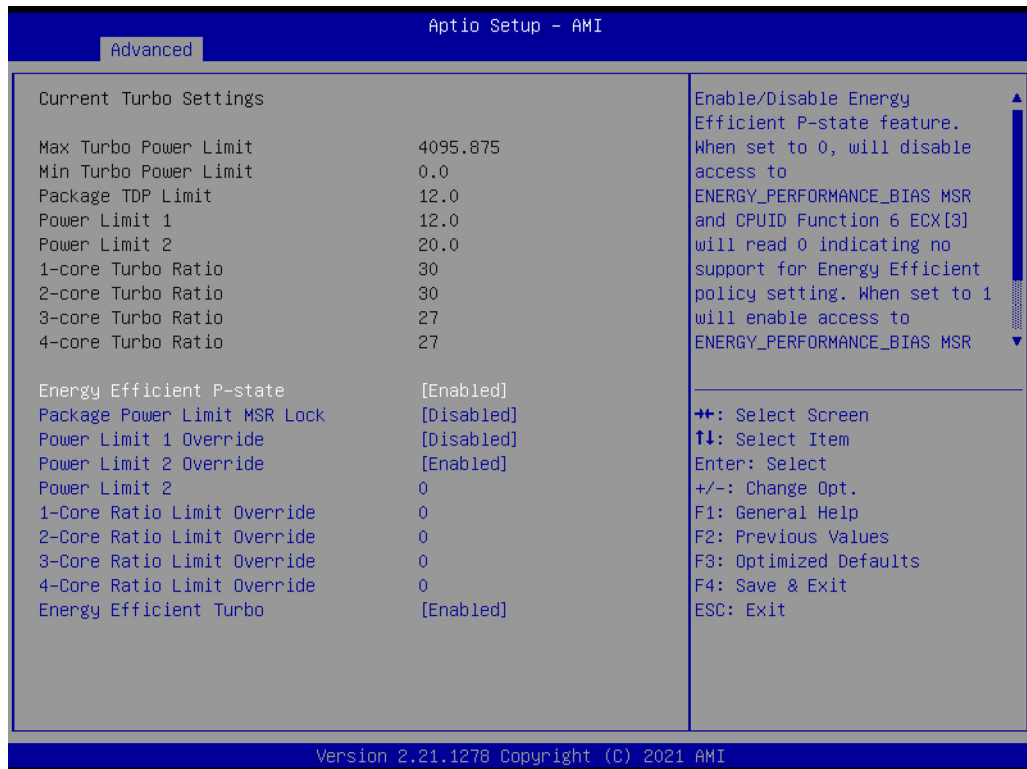

- **Energy Efficient P-state**
Enable/Disable Energy Efficient P-state feature.
- **Package Power Limit MSR Lock**
Enable/Disable locking of Package Power Limit 1 settings.
- **Power Limit 1 Override**
Enable/Disable Power Limit 1 override.
- **Power Limit 2 Override**
Enable/Disable locking of Package Power Limit 2 settings.
- **Power Limit 2**
Power Limit 2 value in Milli Watts.
- **1-Core Turbo Ratio Limit Ratio (TRLR) Override**
1-Core Turbo Ratio Limit Ratio (TRLR).
- **2-Core Turbo Ratio Limit Ratio (TRLR) Override**
2-Core Turbo Ratio Limit Ratio (TRLR).
- **3-Core Turbo Ratio Limit Ratio (TRLR) Override**
3-Core Turbo Ratio Limit Ratio (TRLR).
- **4-Core Turbo Ratio Limit Ratio (TRLR) Override**
4-Core Turbo Ratio Limit Ratio (TRLR).
- **Energy Efficient Turbo**
Enable/Disable Energy Efficient Turbo feature.

Power Limit 3 Settings

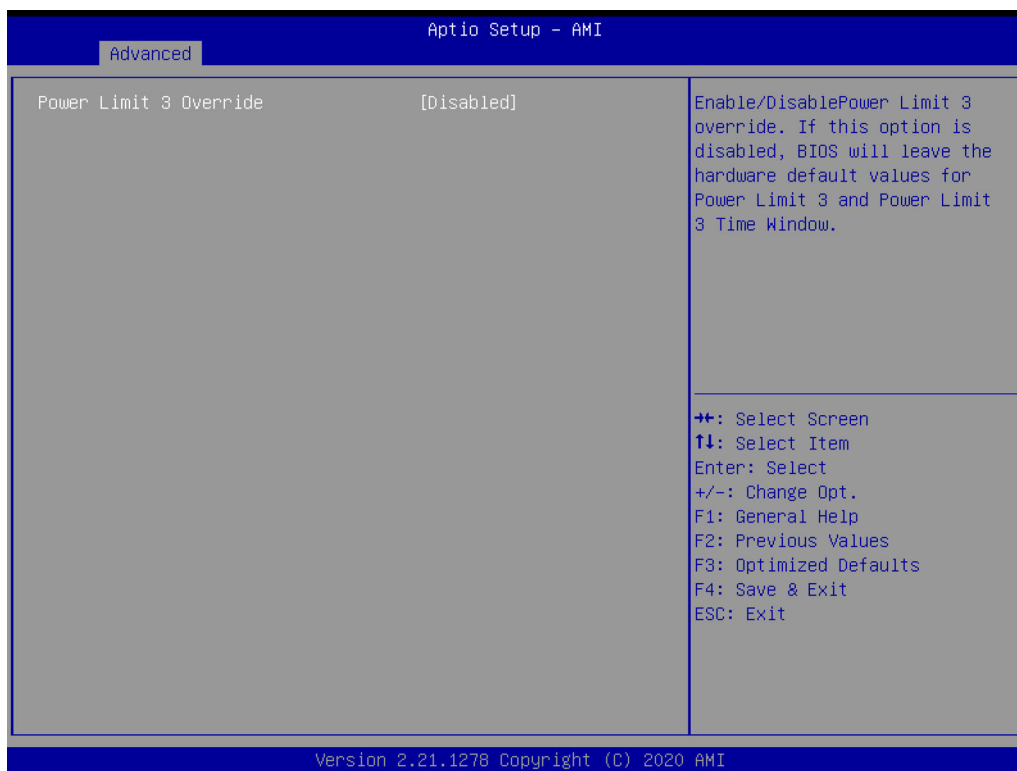

- **Power Limit 3 Override**
Enable/Disable Power Limit 3 override.

GT - Power Management Control



- **RC6 (Render Standby)**
Check to enable render standby support.
- **Maximum GT frequency**
Maximum GT frequency limited by user.
- **Disable Turbo GT frequency**
Enable/Disable Turbo GT frequency.

4.1.1.4 PCH-FW Configuration

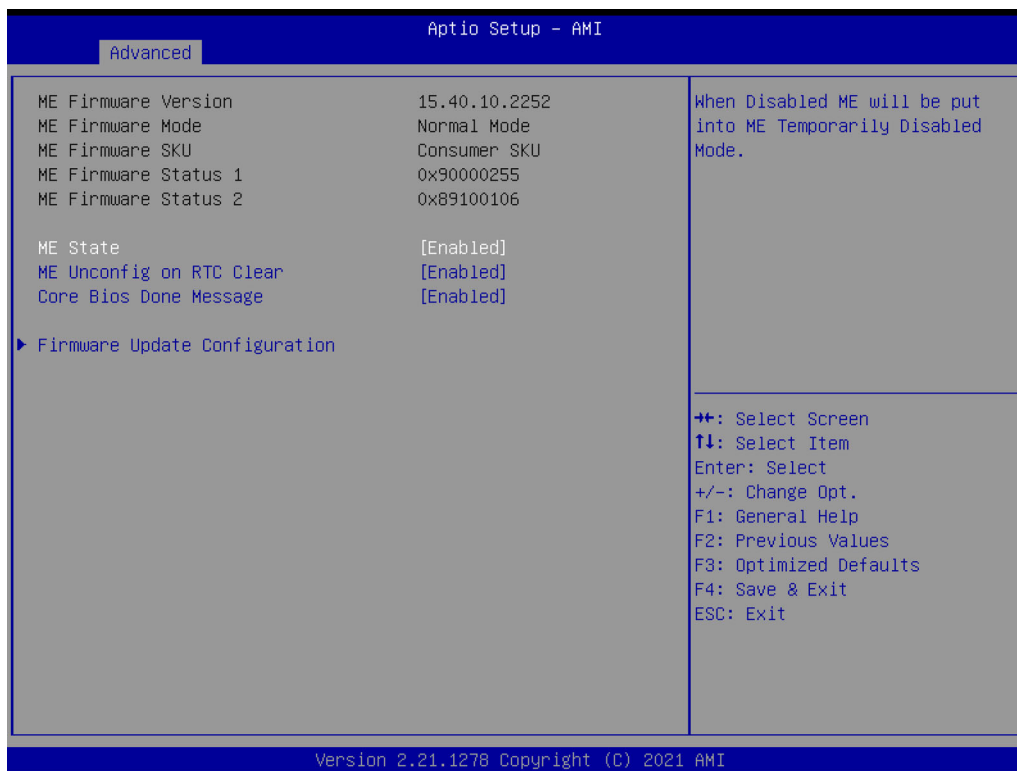

- **ME State**
When disabled ME will be put ME into temporarily disabled mode.
- **ME Unconfig on RTC Clear**
When disabled, ME will not be unconfigured on RTC Clear.
- **Core BIOS Done Message**
Enable/Disable Core BIOS done message sent to ME.
- **Firmware Update Configuration**
Configure management engine technology parameters.

4.1.1.5 ACPI Settings

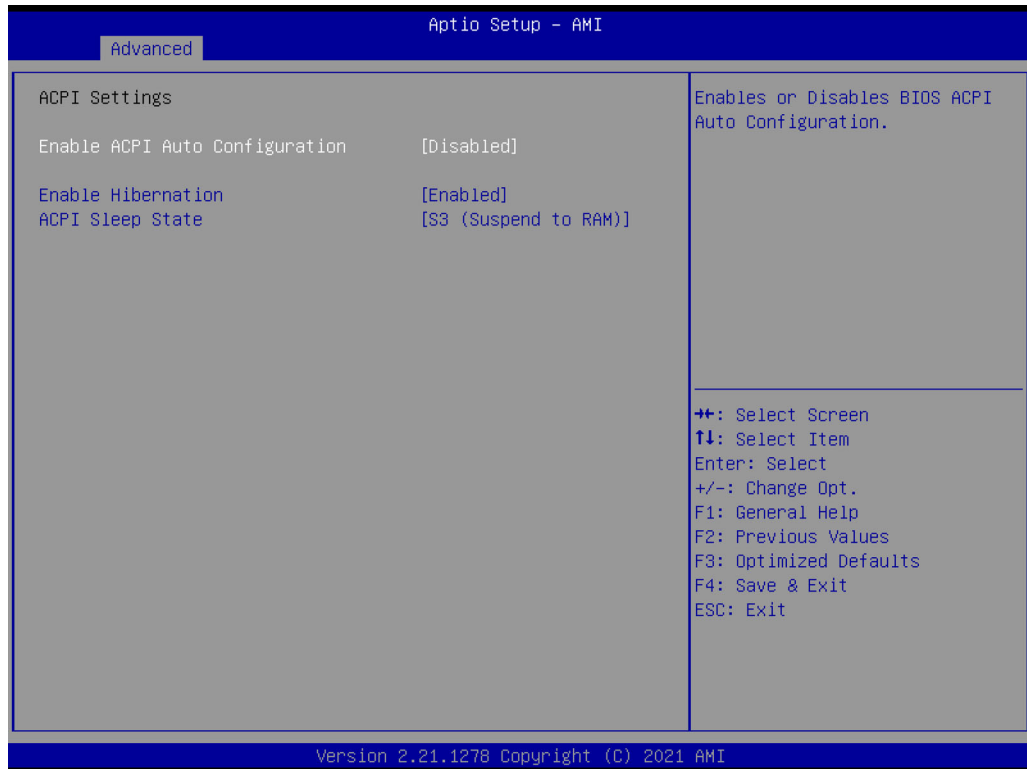

- **Enable ACPI Auto Configuration**
Enable or disable BIOS ACPI auto configuration.
- **Enable Hibernation**
Enables or disables system ability to Hibernate (OS/S4 Sleep State). This option may be not effective with some OS.
- **ACPI Sleep State**
Selects the highest ACPI sleep state the system will enter when the SUSPEND button is pressed.

4.1.1.6 iManager Configuration

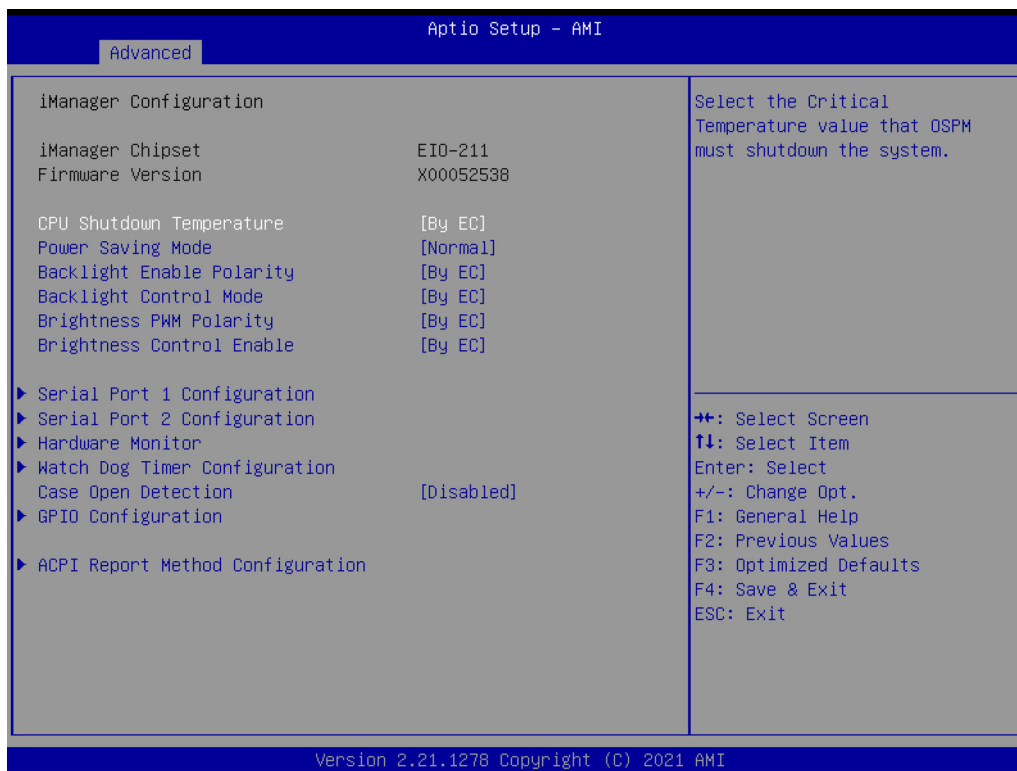

- **CPU Shutdown Temperature**
Enable/Disable CPU Shutdown Temperature.
- **Power Saving Mode**
Enable/Disable power saving mode.
- **Backlight Enable Polarity**
Switch Backlight Enable Polarity for Native or Invert.
- **Backlight Control Mode**
Switch Backlight Control to PWM or DC mode.
- **Brightness PWM Polarity**
Backlight Control Brightness PWM Polarity for Native or Invert.
- **Brightness Control Enable**
Choose to control LVDS brightness value by EC or user override during POST stage.
- **Serial Port 1 Configuration**
Set Parameters of Serial Port 1.
- **Serial Port 2 Configuration**
Set Parameters of Serial Port 2.
- **Hardware Monitor**
Monitors hardware status.
- **Watch Dog Timer Configuration**
Watch dog timer configuration page.
- **Case Open Detection**
Enable or disable case open detect function.
- **GPIO Configuration**
GPIO configuration settings.
- **ACPI Report Method Configuration**
Select ACPI reporting method for EC devices.

Serial Port 1 Configuration



- **Serial Port**
Enable or disable Serial Port (COM).
- **Change Settings**
Select an optimal settings for Super IO device.
- **COM Port Mode**
COM Port Mode selection.

Serial Port 2 Configuration

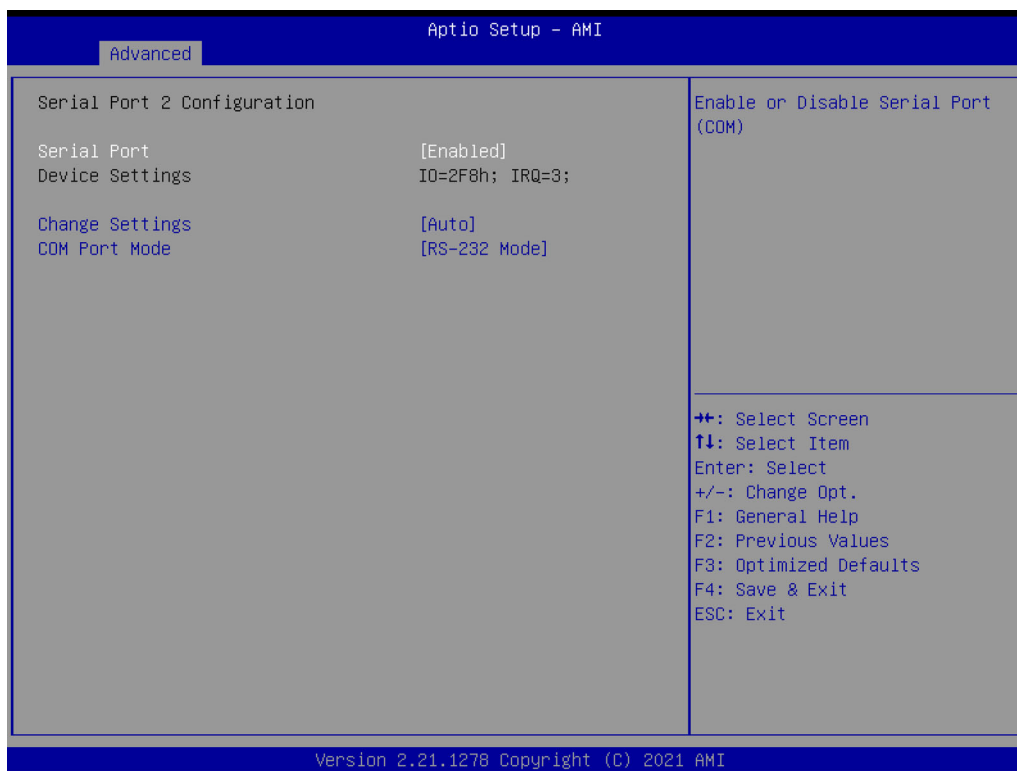

- **Serial Port**
Enable or disable Serial Port (COM).
- **Change Settings**
Select an optimal settings for Super IO device.
- **COM Port Mode**
COM Port Mode selection.

Hardware Monitor

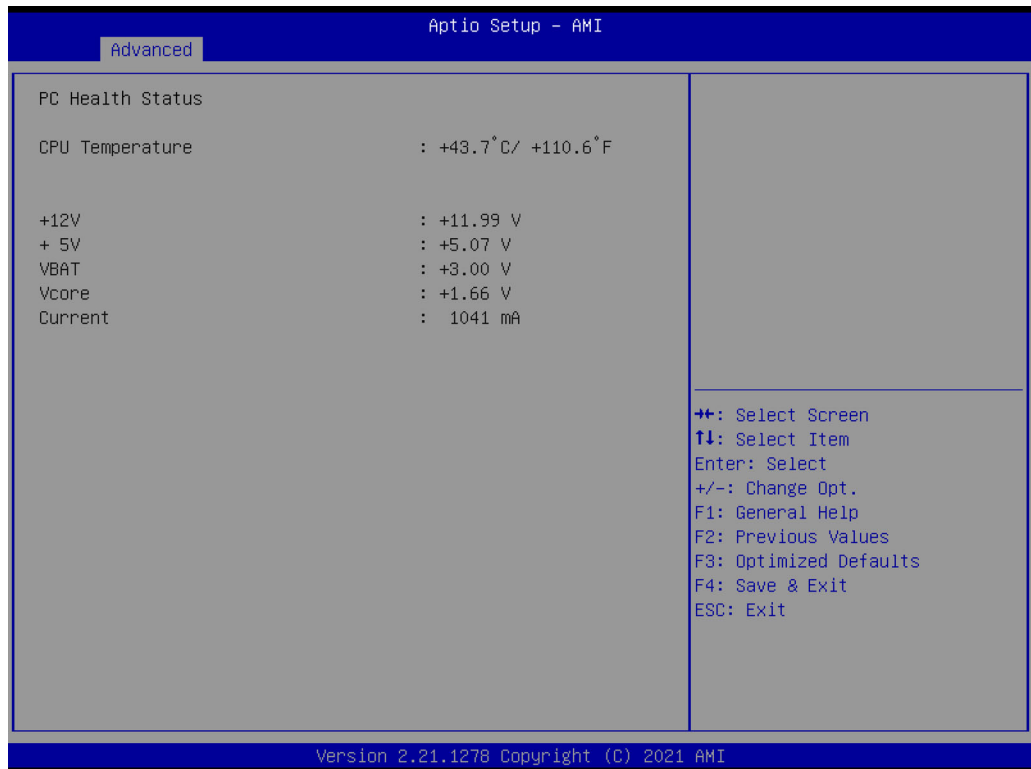

Watch Dog Timer Configuration



- **Watch Dog Timer**
Enable or disable watch dog timer function.

GPIO Configuration

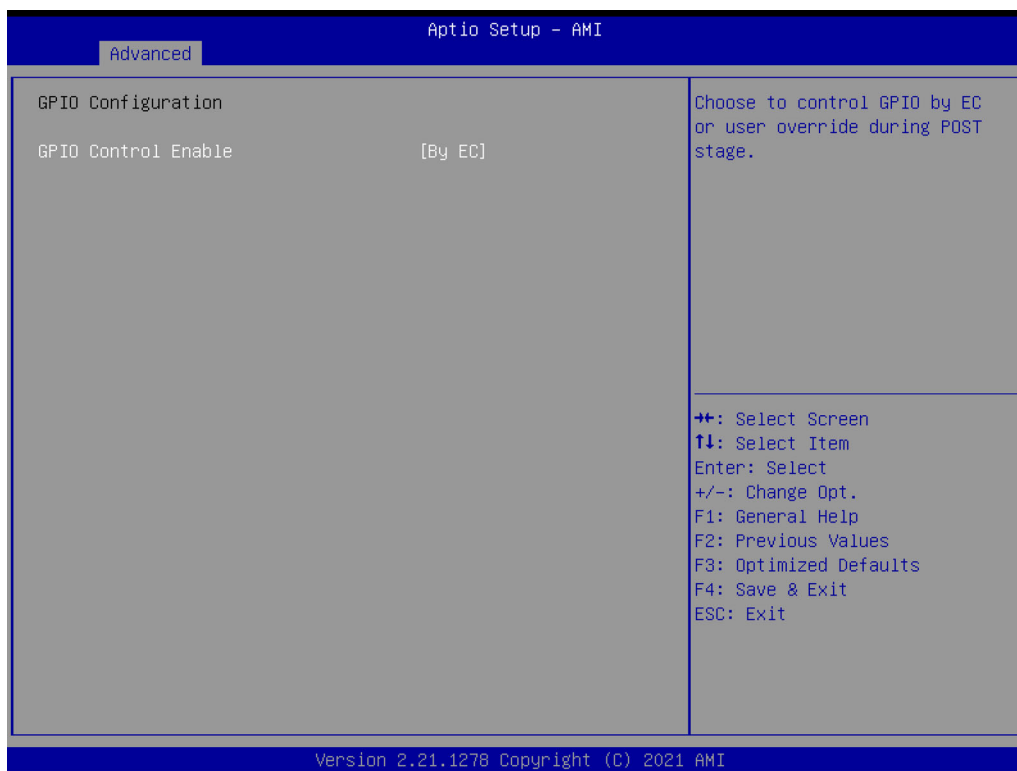

- **GPIO Control Enable**
Choose to control GPIO by EC or user override during POST stage.
- **GPIO0/1/2/3/4/5/6/7**
Configure GPIO0/1/2/3/4/5/6/7.

ACPI Report Method Configuration



- **ACPI Report Method Control**
Select ACPI reporting method for EC Devices.
- **Active High-Speed COM Port**
Select to Enable High-Speed COM Port or Standard COM Port.
- **ACPI Report Method for I2C Bus**
Select ACPI reporting method for EC I2C Bus.
- **ACPI Report Method for SMBus**
Select ACPI reporting method for EC SMBus.
- **ACPI Report Method for GPIO**
Select ACPI reporting method for EC GPIO.

4.1.1.7 NCT6126D HW Monitor

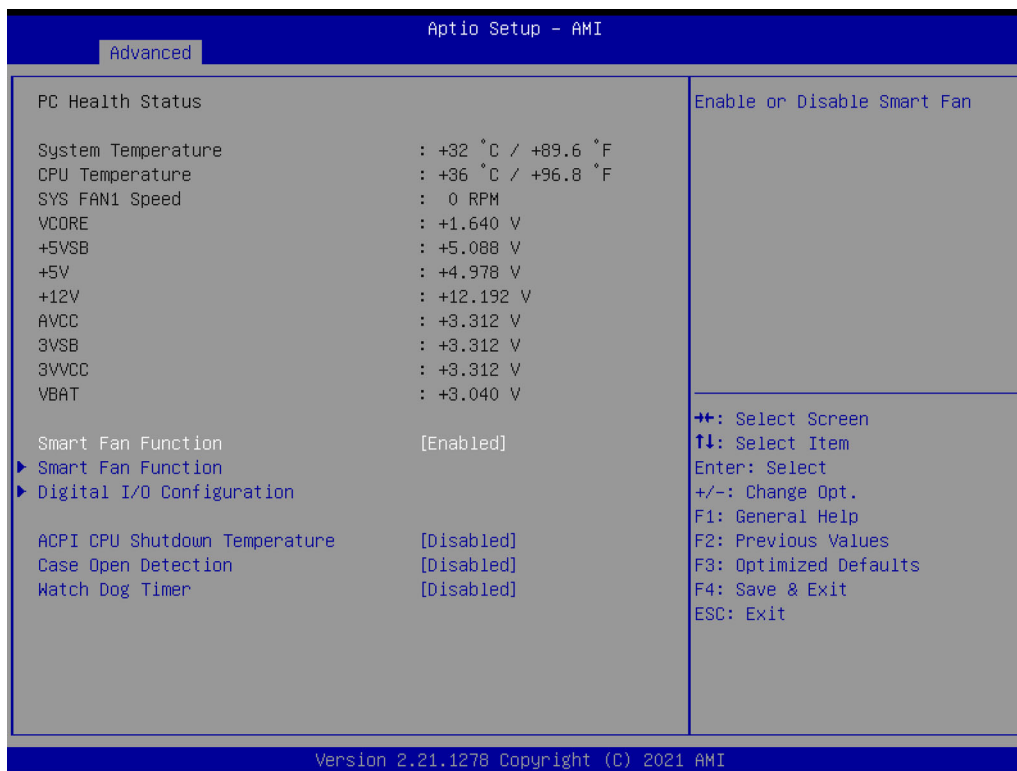

- **Smart Fan Function**
Enable or disable Smart Fan.
- **Smart Fan Function**
Enable or disable Smart Fan.
- **Digital I/O Configuration**
Configure the digital I/O pins.
- **ACPI CPU Shutdown Temperature**
Select the critical temperature value that OSPM must shutdown the system.
- **Case Open Detection**
Enable or disable Case Open Detect Function.
- **Watch Dog Timer**
Enable or disable Watch Dog Timer Function.

4.1.1.8 Trusted Computing

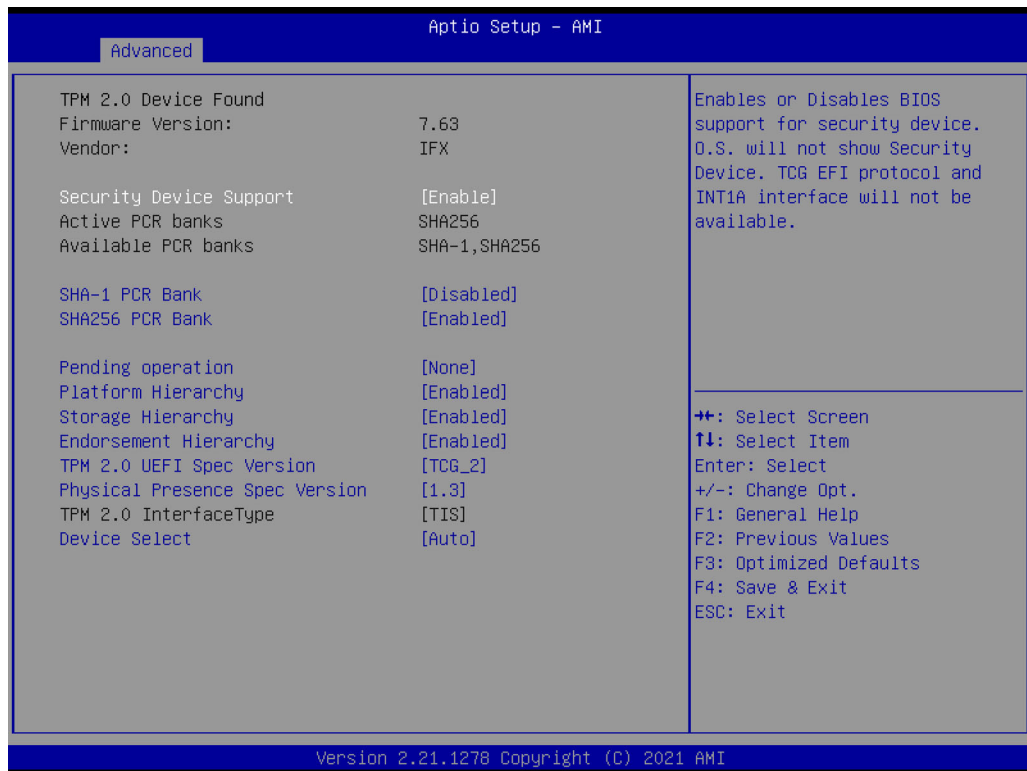

- **Security Device Support**
Enable or disable BIOS support for security device.
- **SHA-1 PCR Bank**
Enable or disable SHA-1 PCR Bank.
- **SHA256 PCR Bank**
Enable or disable SHA256 PCR Bank.
- **SHA384 PCR Bank**
Enable or disable SHA384 PCR Bank.
- **Pending operation**
Schedule an operation for a security device.
- **Platform Hierarchy**
Enable or disable Platform Hierarchy.
- **Storage Hierarchy**
Enable or disable Storage Hierarchy.
- **Endorsement Hierarchy**
Enable or disable Endorsement Hierarchy.
- **TPM 2.0 UEFI Spec Version**
Select the TCG2 Spec Version support.
- **Physical Presence Spec Version**
Select to Tell O.S. to support PPI Spec Version 1.2 or 1.3.
- **Device Select**
TPM 1.2 will restrict support to TPM 1.2 devices, TPM 2.0 will restrict support to TPM 2.0 devices.

4.1.1.9 S5 RTC Wake Settings



- Wake system from S5**
 Enable or disable System wake on alarm event. Select FixedTime, system will wake on the hr:min:sec specified.

4.1.1.10 Serial Port Console Redirection

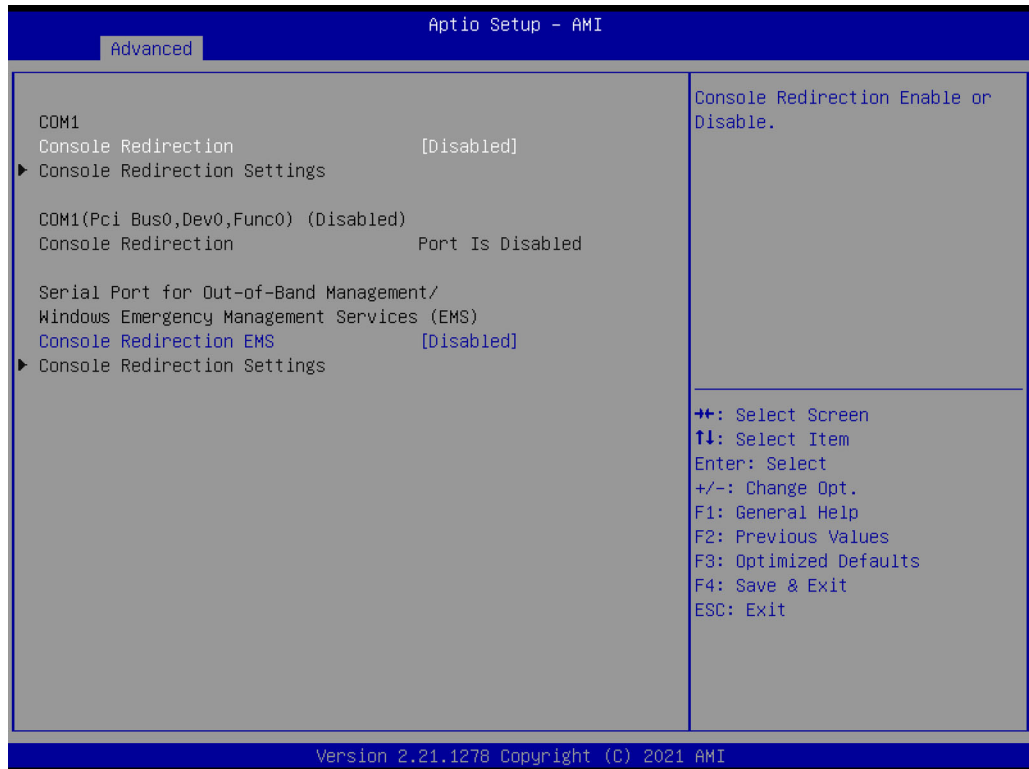

- **Console Redirection**
This item allows users to enable or disable console redirection for Microsoft Windows Emergency Management Services (EMS).
- **Console Redirection**
This item allows users to configuration console redirection detail settings.

4.1.1.11 USB Configuration



- **Legacy USB Support**
Enables Legacy USB Support. AUTO option disables legacy support if no USB devices are connected. Disable option will keep USB devices available only for EFI applications.
- **XHCI Hand-off**
This is a workaround for OS without XHCI hand-off support. The XHCI ownership change should be claimed by XHCI driver.
- **USB Mass Storage Driver Support**
Enable/disable USB Mass Storage Driver support.
- **USB transfer time-out**
Time-out value for control, bulk, and interrupt transfers.
- **Device reset time-out**
USB mass storage device start unit command time-out.
- **Device power-up delay**
Maximum time the device will take before it properly reports itself to the Host Controller. 'Auto' uses default value: for a root port it is 100 ms, for a hub port the delay is taken from hub descriptor.

4.1.1.12 Network Stack Configuration



- **Network Stack**
Enable/disable UEFI Network Stack.

4.1.1.13 NVMe Configuration

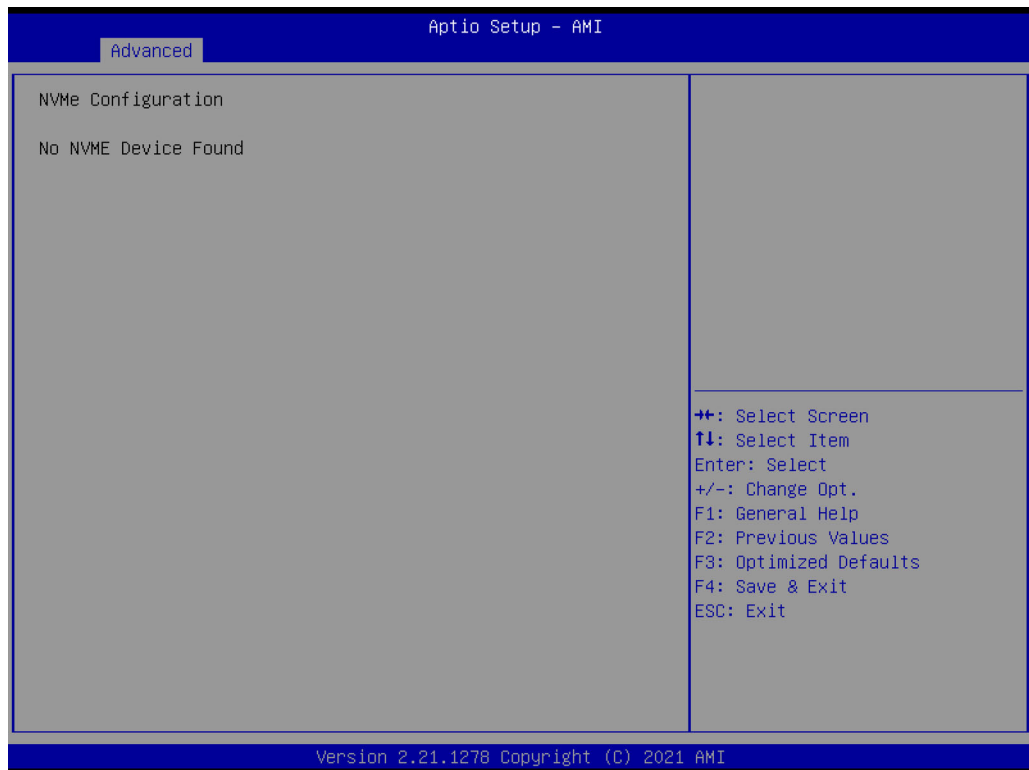

4.1.1.14 SDIO Configuration



- **SDIO Access Mode**
Select SD Device access mode in Auto/DMA/PIO.

4.1.2 Chipset Configuration

Select the Chipset tab from the MIO-2363 setup screen to enter the Chipset BIOS Setup screen. You can display a Chipset BIOS Setup option by highlighting it using the <Arrow> keys. All Plug and Play BIOS Setup options are described in this section. The Plug and Play BIOS Setup screen is shown below.



4.1.2.1 System Agent (SA) Configuration

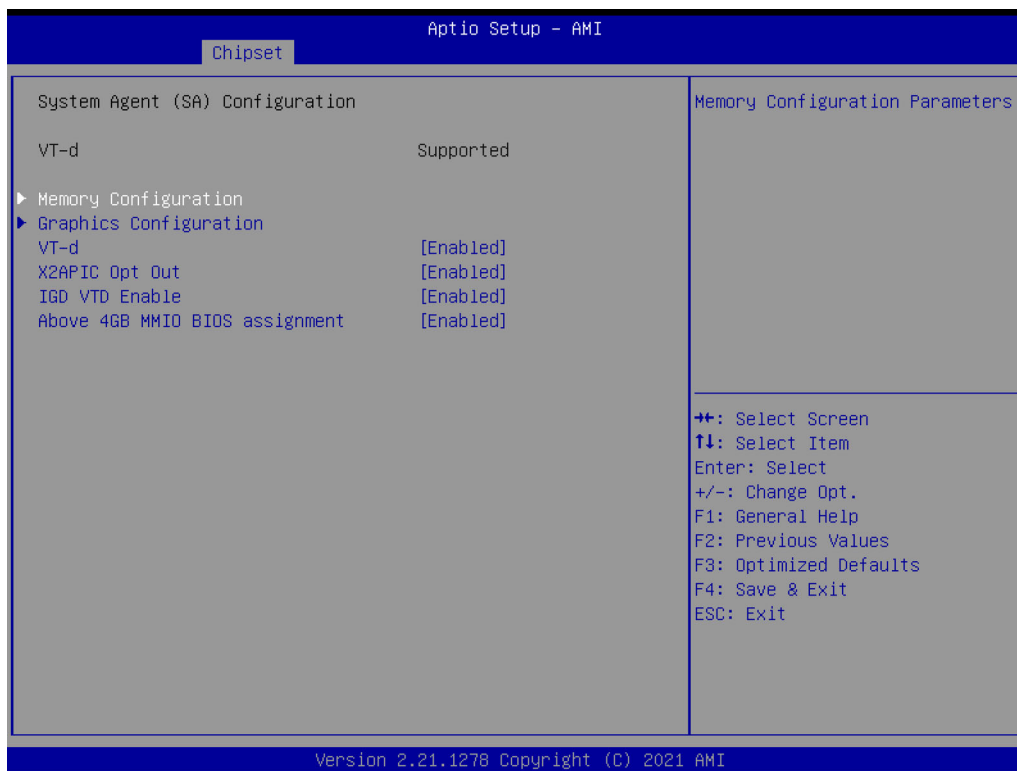

- **Memory Configuration**
Memory configuration parameters.
- **Graphics Configuration**
Graphics configuration parameters.
- **VT-d**
VT-D capability.
- **X2APIC Opt Out**
Enable/Disable X2APIC opt out bit.
- **IGD VTD Enable**
Enable/Disable IGD VTD.
- **Above 4GB MMIO BIOS assignment**
Enable/Disable above 4GB Memory Mapped IO BIOS assignment.

Memory Configuration

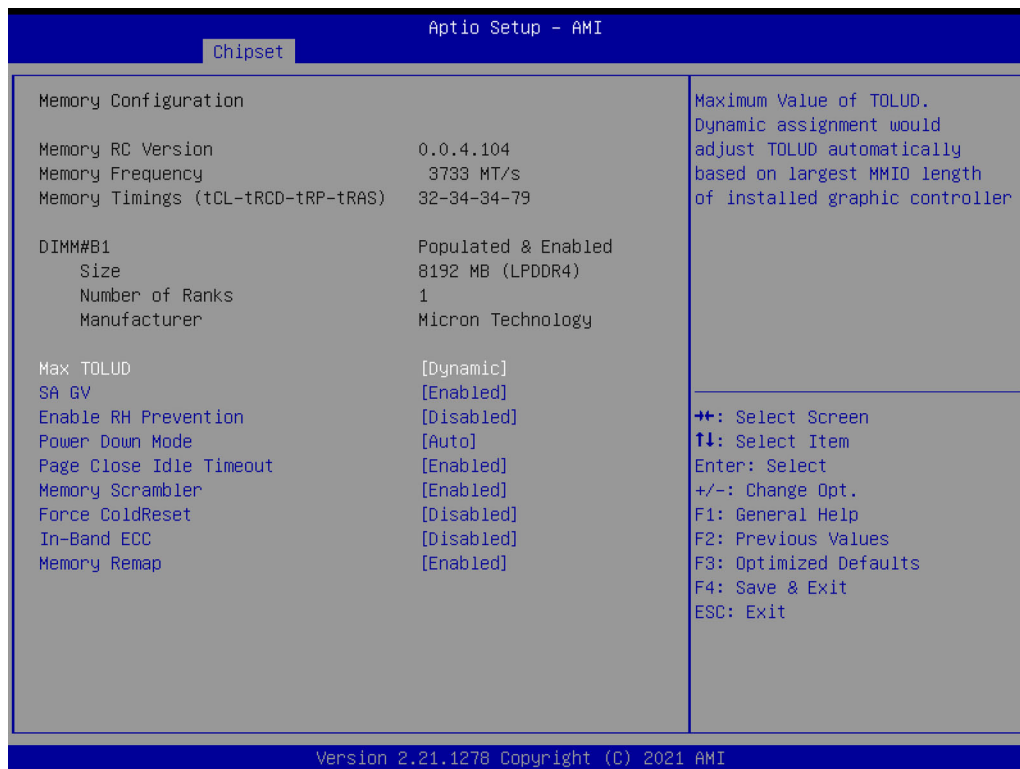

- **Max TOLUD**
Maximum Value of TOLUD.
- **SAGV**
System Agent Geyserville.
- **Enable RH Prevention**
Actively prevent row hammer attacks.
- **Power Down Mode**
CKE Power Down Mode control.
- **Page Close Idle Timeout**
Page Close Idle Timeout Control.
- **Memory Scrambler**
Enable/Disable Memory Scrambler support.
- **Force ColdReset**
Force ColdReset or choose MrcColdBoot mode.
- **In-Band ECC**
Enable/Disable In-Band ECC.
- **Memory Remap**
Enable/Disable memory remap above 4GB.

Graphics Configuration

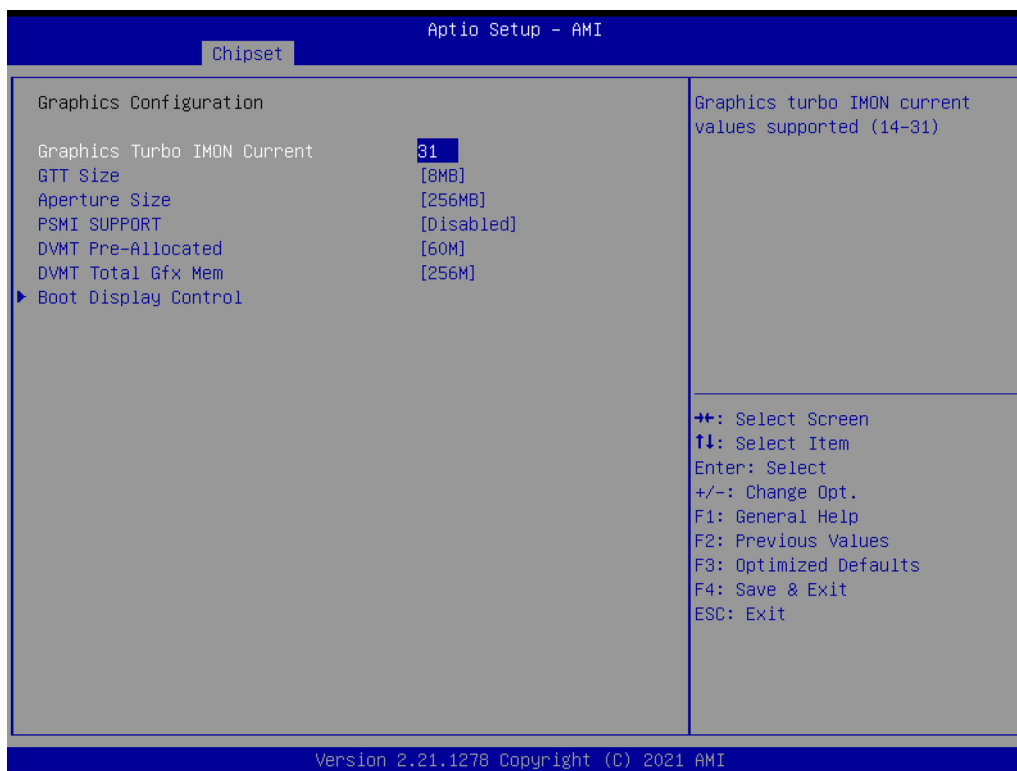

- **Graphics Turbo IMON Current**
Graphics turbo IMON current values supported.
- **GTT Size**
Select the GTT size.
- **Aperture Size**
Select the aperture size.
- **PSMI Support**
Enable/Disable PSMI.
- **DVMT Pre-Allocated**
Select DVMT 5.0 Pre-Allocated (fixed) graphics memory size used by the internal graphics device.
- **DVMT Total Gfx Mem**
Select DVMT 5.0 total graphic memory size used by the internal graphics device.
- **Boot Display Control**
Boot display control.

Boot Display Control

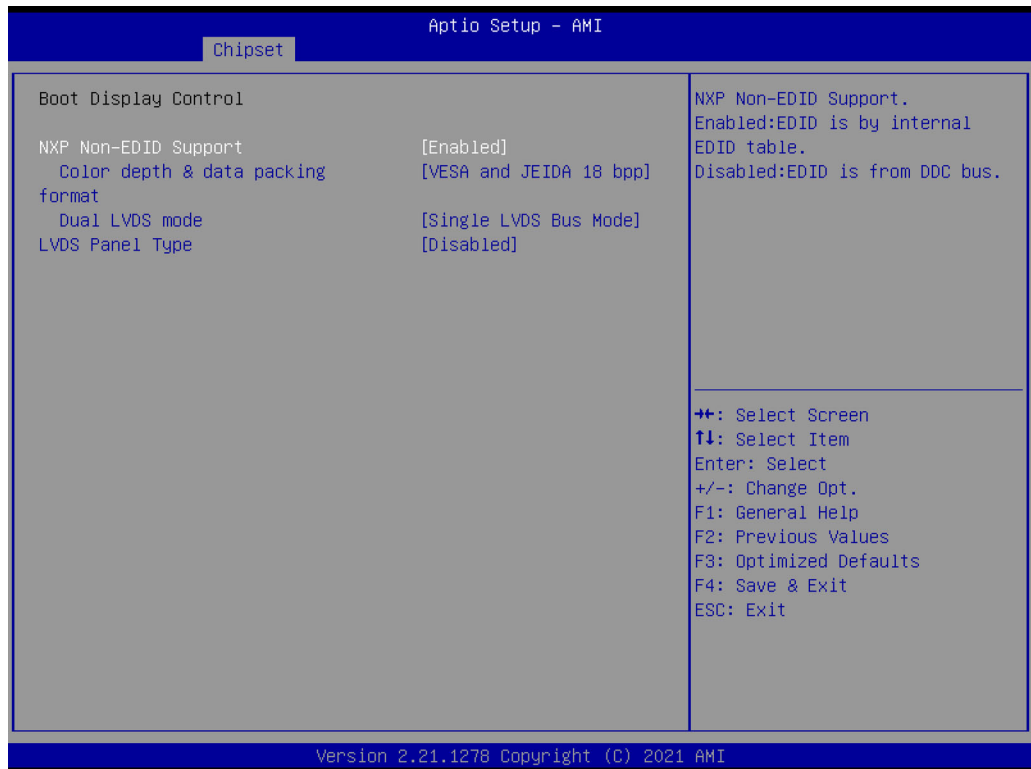

- **NXP Non-EDID Support**
Non-EDID support.
- **Color Depth & Data Packing**
Color depth and data packing format for Non-EDID support.
- **Dual LVDS Mode**
Select LVDS bus to single bus mode or dual bus mode.
- **LVDS Panel Type**
This item allow user to select LVDS panel resolution type.

4.1.2.2 PCH-IO Configuration

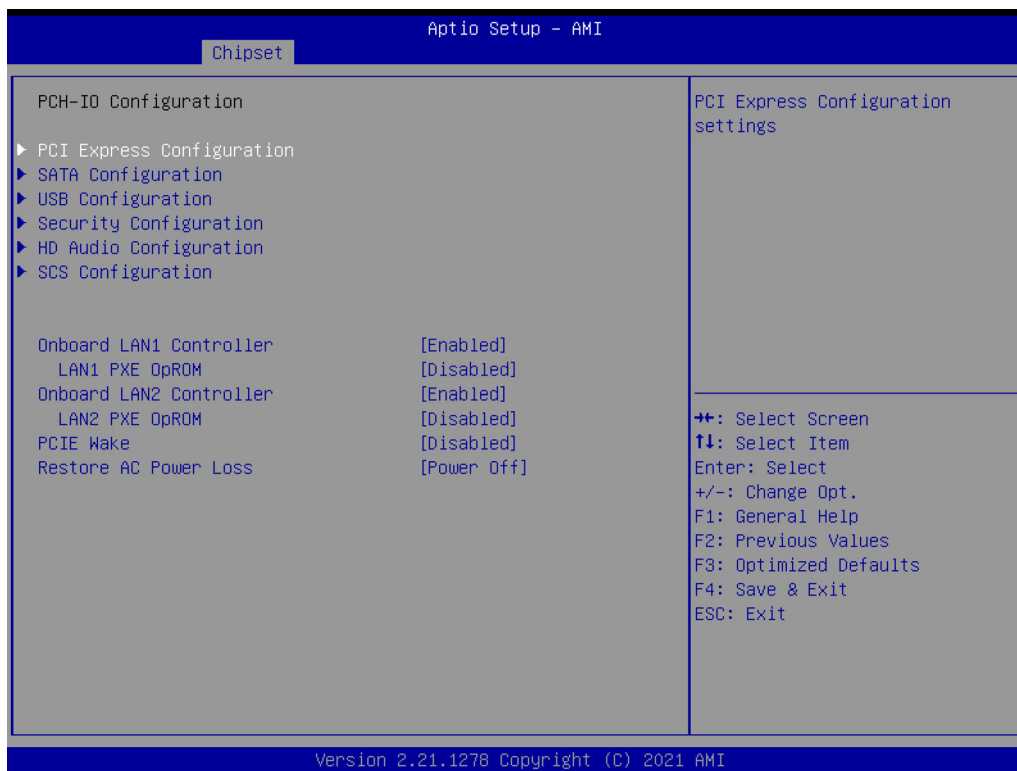

- **PCI Express Configuration**
PCI Express configuration settings.
- **SATA Configuration**
SATA device options settings.
- **USB Configuration**
USB configuration settings.
- **Security Configuration**
Security configuration settings.
- **HD Audio Configuration**
HD Audio subsystem configuration settings.
- **SCS Configuration**
Storage and communication subsystem (SCS) configuration.
- **Onboard LAN1 Controller**
Select to enable or disable Onboard LAN1 controller.
- **LAN1 PXE ROM**
Enable or disable onboard LAN1's PXE option ROM.
- **Onboard LAN2 Controller**
Select to enable or disable Onboard LAN2 controller.
- **LAN2 PXE ROM**
Enable or disable onboard LAN2's PXE option ROM.
- **PCIE Wake**
Enable or disable PCIE to wake the system from S5.
- **Restore AC Power Loss**
Specify what state to go to when power is re-applied after a power failure (G3 state).

PCI Express Configuration

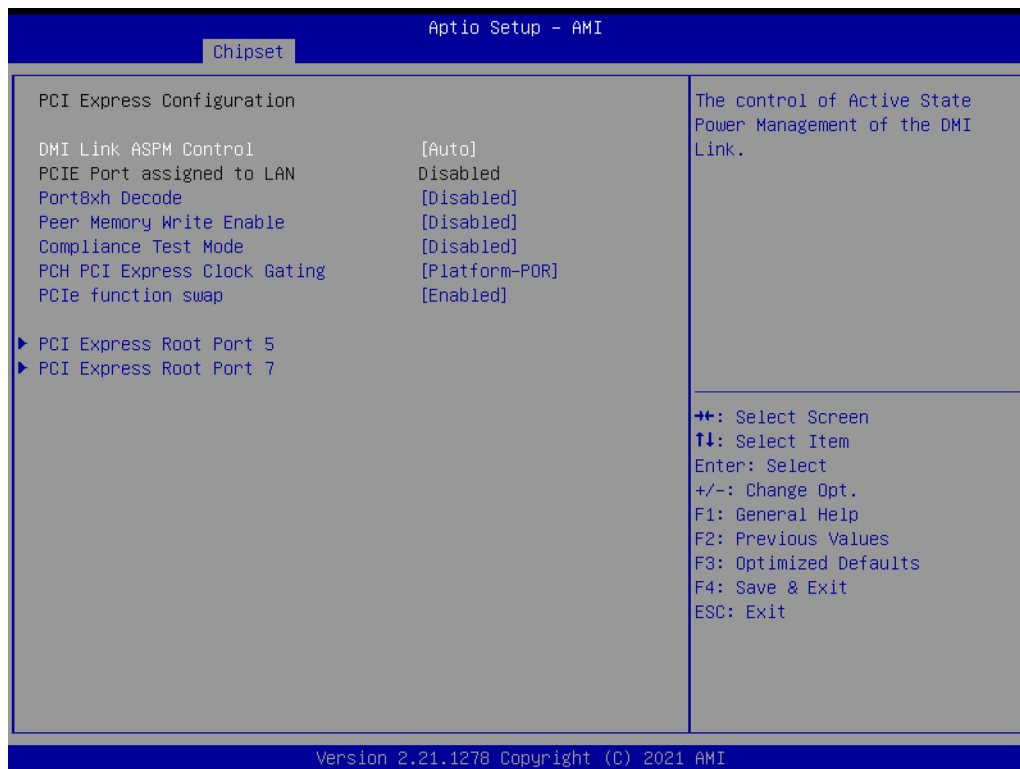

- **DMI Link ASPM Control**
This item controls Active State Power Management of the DMI link.
- **Port8xh Decode**
PCI Express Port8xh decode enable/disable.
- **Peer Memory Write Enable**
Peer memory write enable/disable.
- **PCH PCI Express Clock Gating**
Enable/Disable PCH PCI Express clock gating for each root port.
- **PCIe function swap**
When disabled, prevents PCIe root port function swap. If any function other than 0 is enabled, 0 will become visible.
- **PCI Express Root Port 5/7**
PCI Express Port 5/7 settings.

SATA Configuration

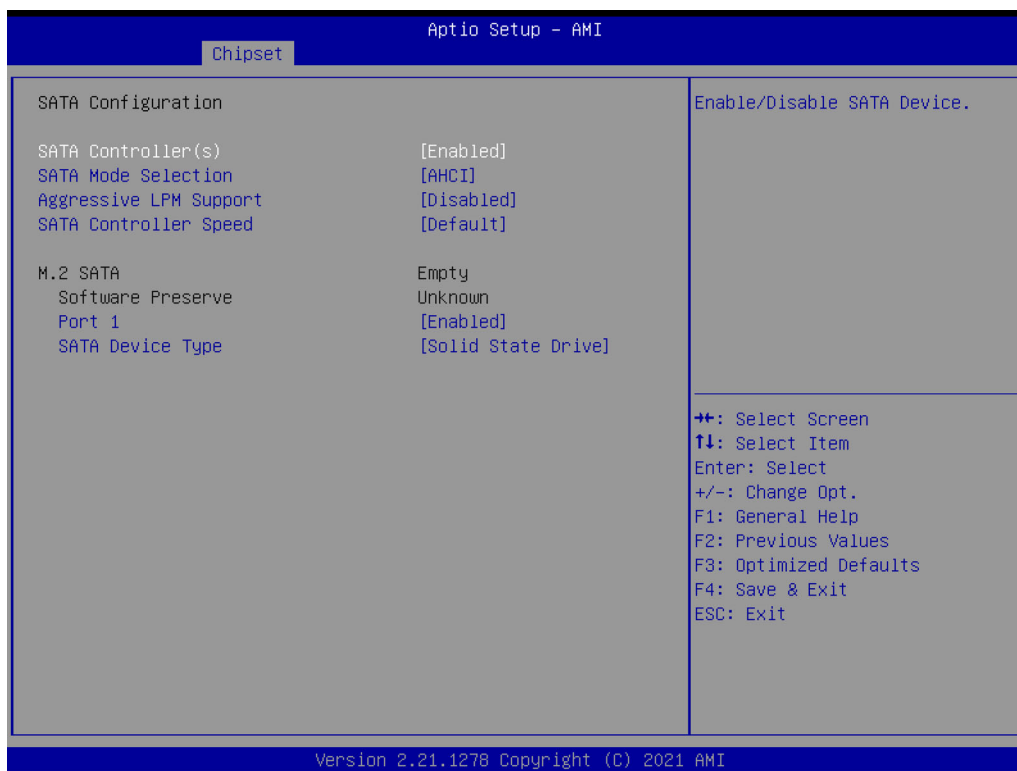

- **SATA Controller(s)**
Enable/disable SATA device.
- **SATA Mode Selection**
Determine how SATA controllers operate.
- **Aggressive LPM Support**
Enabled PCH to aggressively enter link power state.
- **SATA Controller Speed**
Indicates the maximum speed the SATA controller can support.

USB Configuration

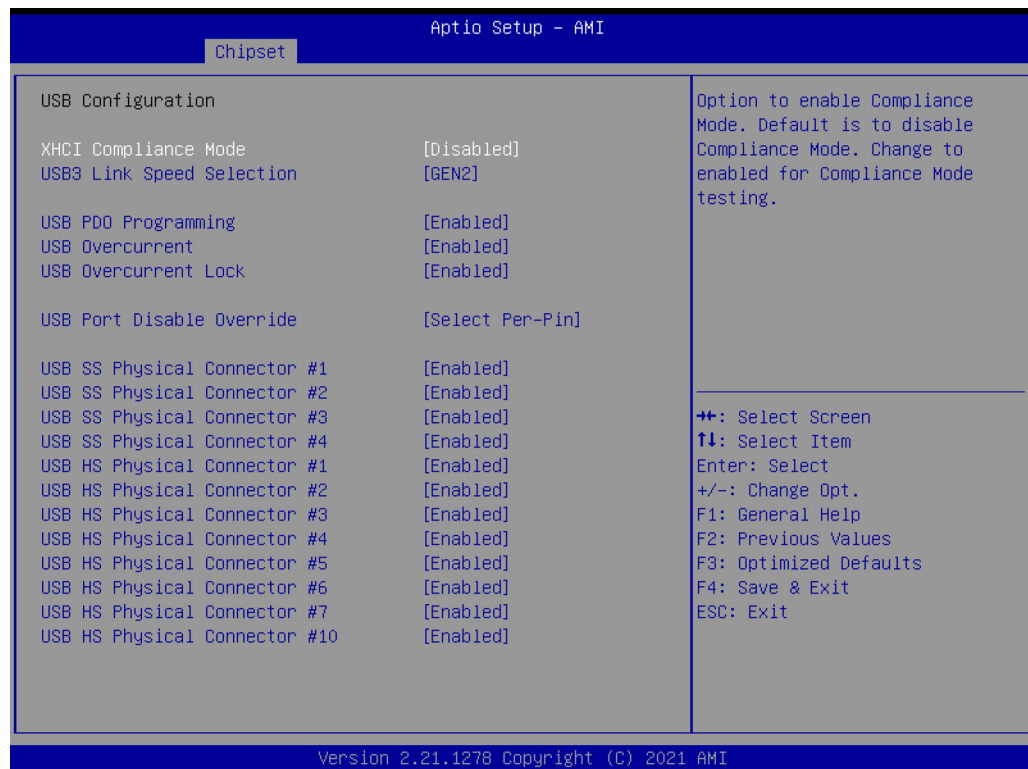

- **XHCI Compliance Mode**
Option to enable compliance mode.
- **USB3 Link Speed Selection**
This option is to select USB3 Link Speed GEN1 or GEN2.
- **USB PDO Programming**
Select “Enabled” if Port Disable Override functionality is used.
- **USB Overcurrent**
Select “Disabled” for pin-based debug.
- **USB Overcurrent Lock**
Select “Enabled” if overcurrent functionality is used.
- **USB Port Disable Override**
Selectively Enable/Disable the corresponding USB Port from reporting a device connection to the controller.
- **USB SS Physical Connector #1/2/3/4**
Enable/disable this USB Physical Connector.
- **USB HS Physical Connector #1/2/3/4/5/6/7/10**
Enable/disable this USB Physical Connector.

Security Configuration



- **RTC Memory Lock**
Enable will lock bytes 38h-3Fh in the lower/upper 128-byte bank of RTC RAM.
- **BIOS Lock**
Enable or disable the PCH BIOS Lock Enable feature.
- **Force unlock on all GPIO pads**
If Enabled BIOS will force all GPIO pads to be in an unlock state.

HD Audio Configuration



- **HD Audio**
Control detection of the HD-Audio device. Disabled = HDA will be unconditionally disabled. Enabled = HDA will be unconditionally Enabled.

SCS Configuration



- **eMMC 5.1 Controller**
Enable or disable SCS eMMC 5.1 controller.
- **eMMC 5.1 HS400 Mode**
Enable or disable SCS eMMC 5.1 HS400 mode.
- **Enable HS400 software tuning**
Software tuning should improve eMMC HS400 stability at the expense of boot time.
- **Driver Strength**
Sets I/O driver strength.

4.1.3 Security

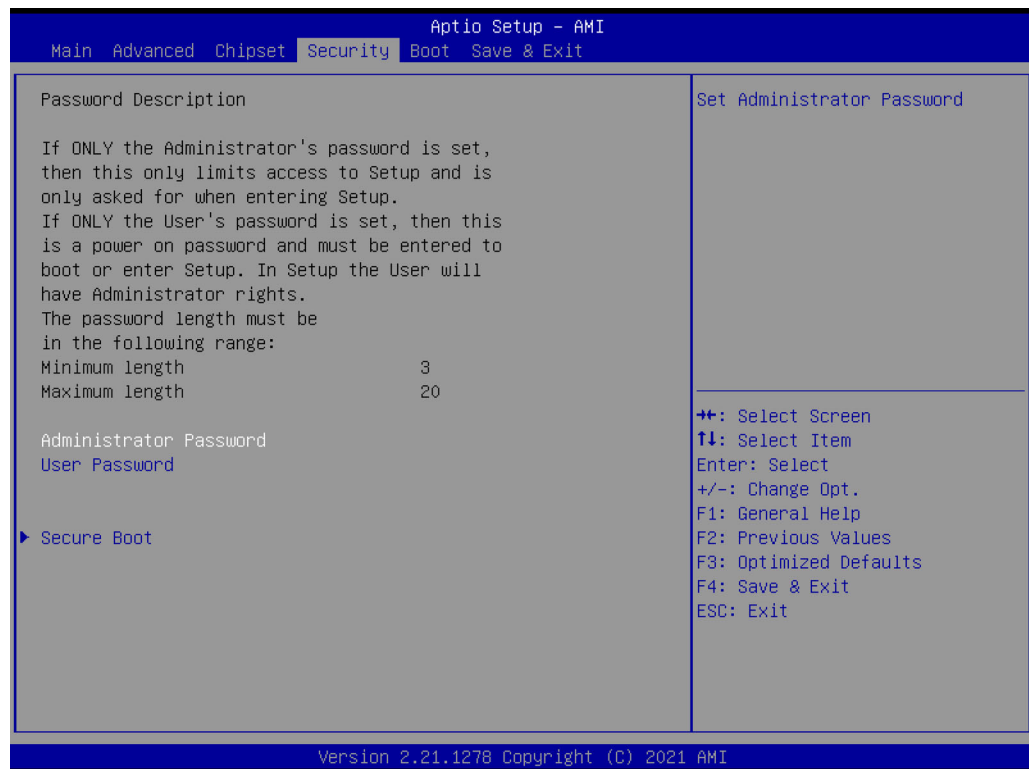

Select Security Setup from the MIO-2363 Setup main BIOS setup menu. All Security Setup options, such as password protection and virus protection are described in this section. To access the sub menu for the following items, select the item and press <Enter>:

- **Change Administrator/User Password**
Select this option and press <ENTER> to access the sub menu, then type in the password.
- **Secure Boot**
Secure boot configurations.

4.1.4 Boot

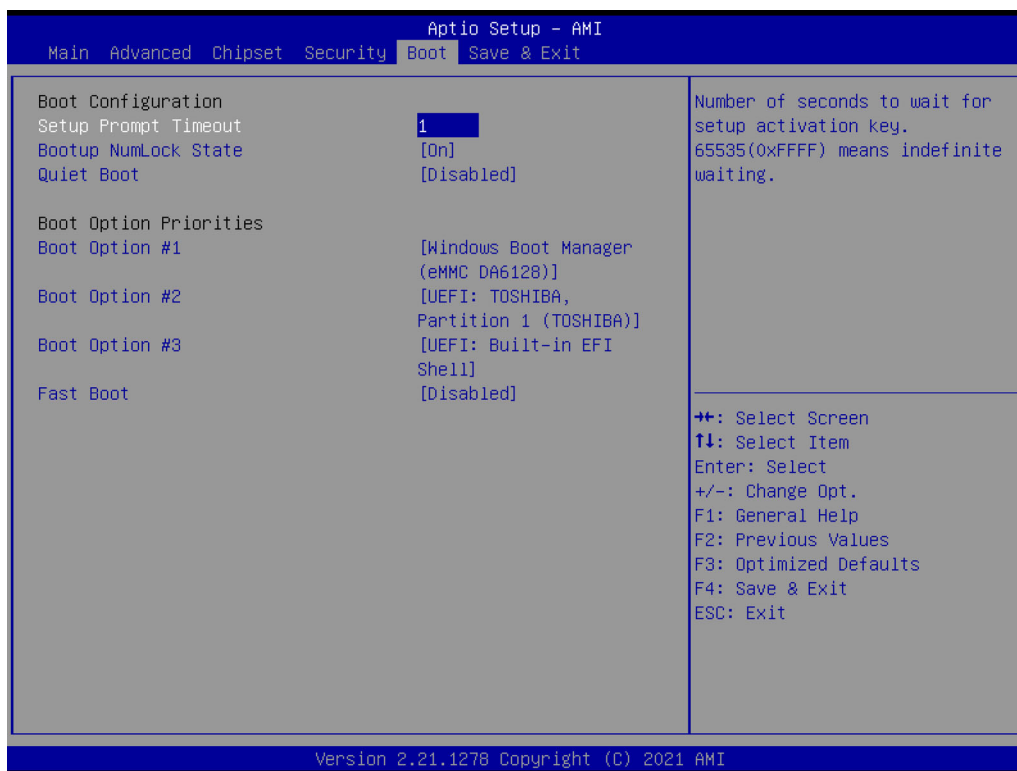

- **Setup Prompt Timeout**
 Number of seconds that the firmware will wait before initiating the original default boot selection. A value of 0 indicates that the default boot selection is to be initiated immediately on boot. A value of 65535 (0xFFFF) indicates that firmware will wait for user input before booting. This means the default boot selection is not automatically started by the firmware.
- **Bootup NumLock State**
 Select the keyboard NumLock state.
- **Quiet Boot**
 Enables or disables Quiet Boot option.
- **Boot Option #1**
 Sets the system boot order.
- **Fast Boot**
 Enables or disables boot with initialization of a minimal set of devices required to launch active boot option. Has no effect for BBS boot options.

4.1.5 Save & Exit



- **Save Changes and Exit**
This item allows you to exit system setup after saving the changes.
- **Discard Changes and Exit**
This item allows you to exit system setup without saving any changes.
- **Save Changes and Reset**
This item allows you to reset the system after saving the changes.
- **Discard Changes and Reset**
This item allows you to rest system setup without saving any changes.
- **Save Changes**
This item allows you to save changes done so far to any of the options.
- **Discard Changes**
This item allows you to discard changes done so far to any of the options.
- **Restore Defaults**
This item allows you to restore/load default values for all the options.
- **Save as User Defaults**
This item allows you to save the changes done so far as user defaults.
- **Restore User Defaults**
This item allows you to restore the user defaults to all the options.
- **Boot Override**
Boot device select can override your boot priority.

Appendix **A**

System I/O Ports

A.1 System I/O Ports

Addr. Range (Hex) Device

00h-1Fh DMA Controller
20h-2Dh Interrupt Controller
2Eh-2Fh Motherboard resources
30h-3Dh Interrupt Controller
40h-43h Timer/Counter
4Eh-4Fh Motherboard resources
50h-53h Timer/Counter
60h-6Fh 8042 (keyboard controller)/NMI Controller/Microcontroller
70h-7Fh Real-time Controller
80h-8Fh Debug Port/Reserved
90h-9Fh Debug Port/Reset Generator
A0h-ADh Interrupt Controller
B0h-B1h Interrupt Controller
B4h-BDh Power Management
280h-28Fh I2C Controller
290h-29Fh EC Index port and Data port
2A0h-2BFh GPIO Controller
2C0h-2DFh SMBus Controller
2F0h-2F7h EC/PMC Controller
2F8h-2FFh Communications Port (COM2)
3F8h-3FFh Communications Port (COM1)
480h-4CFh Motherboard resources
4D0h-4D1h Interrupt Controller
680h-69Fh Motherboard resources
A00h-AFFh Motherboard resources
164Eh-164Fh Motherboard resources
1800h-18FFh Motherboard resources
CF9h-CF9h Reset Generator

A.2 DMA Channel Assignments

Channel Function

0 Available
1 Available
2 Available
3 Available
4 Direct memory access controller
5 Available
6 Available
7 Available

A.3 1st MB Memory Map

Addr. Range (Hex) Device

E0000h - FFFFFh System board
D0000h - DFFFFh PCI Bus
C0000h - CFFFFh System board
A0000h - BFFFFh PCI Bus
A0000h - BFFFFh Intel® HD Graphic
00000h - 9FFFFh System board

A.4 Interrupt Assignments

Interrupt# Interrupt source

NMI Parity error detected
IRQ0 System timer
IRQ1 Using SERIRQ, Keyboard Emulation
IRQ2 Interrupt from controller 2 (cascade)
IRQ3 Communications Port (COM2)
IRQ4 Communications Port (COM1)
IRQ5 EC Watch Dog
IRQ6 CANBus Controller
IRQ7 Available
IRQ8 System CMOS/real time clock
IRQ9 Microsoft ACPI-Compliant System
IRQ10 Available
IRQ11 Display Controller
IRQ12 Available
IRQ13 Numeric data processor
IRQ14 Reserved
IRQ15 Reserved

ADVANTECH

Enabling an Intelligent Planet

www.advantech.com

Please verify specifications before quoting. This guide is intended for reference purposes only.

All product specifications are subject to change without notice.

No part of this publication may be reproduced in any form or by any means, such as electronically, by photocopying, recording, or otherwise, without prior written permission from the publisher.

All brand and product names are trademarks or registered trademarks of their respective companies.

© Advantech Co., Ltd. 2022

Our company network supports you worldwide with offices in Germany, Austria, Switzerland, the UK and the USA. For more information please contact:

Headquarters

Germany



FORTEC Elektronik AG

Augsburger Str. 2b
82110 Germering

Phone: +49 89 894450-0
E-Mail: info@fortecaq.de
Internet: www.fortecaq.de

Fortec Group Members

Austria



Distec GmbH Office Vienna

Nuschinggasse 12
1230 Wien

Phone: +43 1 8673492-0
E-Mail: info@distec.de
Internet: www.distec.de

Germany



Distec GmbH

Augsburger Str. 2b
82110 Germering

Phone: +49 89 894363-0
E-Mail: info@distec.de
Internet: www.distec.de

Switzerland



ALTRAC AG

Bahnhofstraße 3
5436 Würenlos

Phone: +41 44 7446111
E-Mail: info@altrac.ch
Internet: www.altrac.ch

United Kingdom



Display Technology Ltd.

Osprey House, 1 Osprey Court
Hinchingsbrooke Business Park
Huntingdon, Cambridgeshire, PE29 6FN

Phone: +44 1480 411600
E-Mail: info@displaytechnology.co.uk
Internet: www.displaytechnology.co.uk

USA



Apollo Display Technologies, Corp.

87 Raynor Avenue, Unit 1
Ronkonkoma, NY 11779

Phone: +1 631 5804360
E-Mail: info@apolloDisplays.com
Internet: www.apolloDisplays.com