

OUR GLOBAL  
COMPETENCE  
CENTRES

 APOLLO DISPLAY  
TECHNOLOGIES



 DISTEC



 DISPLAY  
TECHNOLOGY



# Manual

## iBASE

### IB836

3,5" Embedded Single-Board Computer with Intel®

Atom™ x6000 series / Pentium® / Celeron®

Elkhard Lake Processor

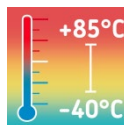
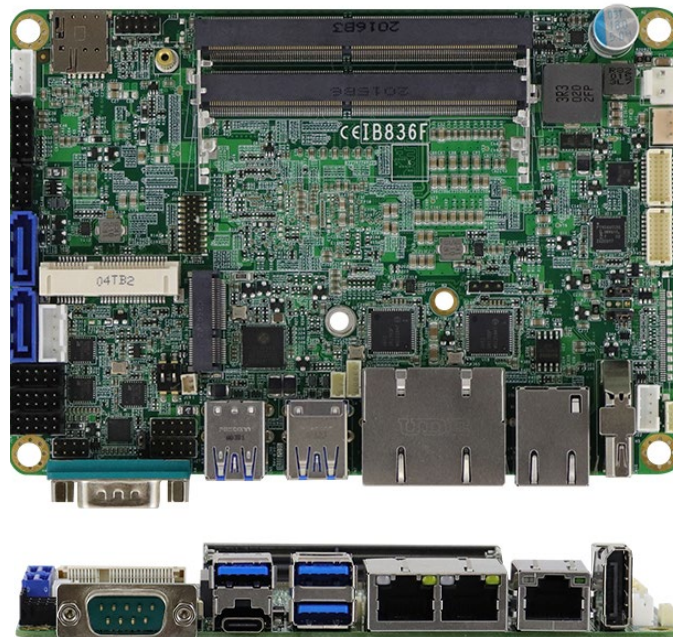

---

The information contained in this document has been carefully researched and is, to the best of our knowledge, accurate. However, we assume no liability for any product failures or damages, immediate or consequential, resulting from the use of the information provided herein. Our products are not intended for use in systems in which failures of product could result in personal injury. All trademarks mentioned herein are property of their respective owners. All specifications are subject to change without notice.

---

# **IB836 Series**

**Intel® Atom™ x6000 series  
/ Pentium®/ Celeron®  
3.5" Disk-Size SBC**

## **User's Manual**

Version 1.0  
(September 2021)

**Copyright**

© 2021 IBASE Technology, Inc. All rights reserved.

No part of this publication may be reproduced, copied, stored in a retrieval system, translated into any language or transmitted in any form or by any means, electronic, mechanical, photocopying, or otherwise, without the prior written consent of IBASE Technology, Inc. (hereinafter referred to as "IBASE").

**Disclaimer**

IBASE reserves the right to make changes and improvements to the products described in this document without prior notice. Every effort has been made to ensure the information in the document is correct; however, IBASE does not guarantee this document is error-free. IBASE assumes no liability for incidental or consequential damages arising from misapplication or inability to use the product or the information contained herein, nor for any infringements of rights of third parties, which may result from its use.

**Trademarks**

All the trademarks, registrations and brands mentioned herein are used for identification purposes only and may be trademarks and/or registered trademarks of their respective owners.



## Compliance



This product has passed CE Class B tests for environmental specifications and limits. This product is in accordance with the directives of the European Union (EU). In a domestic environment, this product may cause radio interference in which case users may be required to take adequate measures.



This product has been tested and found to comply with the limits for a Class B device, pursuant to Part 15 of the FCC Rules. These limits are designed to provide reasonable protection against harmful interference in a residential installation. This equipment generates, uses and can radiate radio frequency energy and, if not installed and used in accordance with manufacturer's instructions, may cause harmful interference to radio communications.

### WEEE



This product must not be disposed of as normal household waste, in accordance with the EU directive of for waste electrical and electronic equipment (WEEE - 2012/19/EU). Instead, it should be disposed of by returning it to a municipal recycling collection point. Check local regulations for disposal of electronic products.

### Green IBASE



This product is compliant with the current RoHS restrictions and prohibits use of the following substances in concentrations exceeding 0.1% by weight (1000 ppm) except for cadmium, limited to 0.01% by weight (100 ppm).

- Lead (Pb)
- Mercury (Hg)
- Cadmium (Cd)
- Hexavalent chromium (Cr6+)
- Polybrominated biphenyls (PBB)
- Polybrominated diphenyl ether (PBDE)

## Important Safety Information

Carefully read the precautions before using the board.

### Environmental conditions:

- Use this product in environments with temperatures between 0°C and 60°C or between -40°C to 85°C depending on the board model.
- Do not leave this product in an environment where the storage temperature may be below -40°C or above 85° C. To prevent from damages, the product must be used in a controlled environment.

### Care for your iBASE products:

- Before cleaning the PCB, unplug all cables and remove the battery.
- Clean the PCB with a circuit board cleaner or degreaser, or use cotton swabs and alcohol.
- Vacuum the dust with a computer vacuum cleaner to prevent the fan from being clogged.



### WARNING

### Anti-static precautions

- Wear an anti-static wrist strap to avoid electrostatic discharge.
- Place the PCB on an anti-static kit or mat.
- Hold the edges of PCB when handling.
- Touch the edges of non-metallic components of the product instead of the surface of the PCB.
- Ground yourself by touching a grounded conductor or a grounded bit of metal frequently to discharge any static.



### CAUTION

There is danger of explosion if the internal lithium-ion battery is replaced by an incorrect type. Replace only with the same or equivalent type recommended by the manufacturer. Dispose of used batteries according to the manufacturer's instructions or recycle them at a local recycling facility or battery collection point.

## Warranty Policy

- **IBASE standard products:**

24-month (2-year) warranty from the date of shipment. If the date of shipment cannot be ascertained, the product serial numbers can be used to determine the approximate shipping date.
- **3<sup>rd</sup>-party parts:**

12-month (1-year) warranty from delivery for the 3<sup>rd</sup>-party parts that are not manufactured by IBASE, such as CPU, CPU cooler, memory, storage devices, power adapter, panel and touchscreen.
- \* PRODUCTS, HOWEVER, THAT FAIL DUE TO MISUSE, ACCIDENT, IMPROPER INSTALLATION OR UNAUTHORIZED REPAIR SHALL BE TREATED AS OUT OF WARRANTY AND CUSTOMERS SHALL BE BILLED FOR REPAIR AND SHIPPING CHARGES.

## Technical Support & Services

1. Visit the IBASE website at [www.ibase.com.tw](http://www.ibase.com.tw) to find the latest information about the product.
2. If you need any further assistance from your distributor or sales representative, prepare the following information of your product and elaborate upon the problem.
  - Product model name
  - Product serial number
  - Detailed description of the problem
  - The error messages in text or in screenshots if there is any
  - The arrangement of the peripherals
  - Software in use (such as OS and application software, including the version numbers)
3. If repair service is required, you can download the RMA form at <http://www.ibase.com.tw/english/Supports/RMAService/>. Fill out the form and contact your distributor or sales representative.

# Table of Contents

---

<b>Chapter 1</b>	<b>General Information .....</b>	<b>1</b>
1.1	Introduction .....	2
1.2	Features .....	3
1.3	Packing List .....	4
1.4	Optional Accessories .....	4
1.5	Specifications .....	5
1.6	Block Diagram .....	7
1.7	Product View .....	8
1.8	Dimensions .....	10
<b>Chapter 2</b>	<b>Hardware Configuration .....</b>	<b>11</b>
2.1	Essential Installations .....	12
2.2	Setting the Jumpers .....	13
2.3	Jumper & Connector Locations .....	14
2.4	Jumpers Quick Reference .....	15
2.5	Connectors Quick Reference .....	19
<b>Chapter 3</b>	<b>Drivers Installation .....</b>	<b>35</b>
3.1	Intel® Chipset Software Installation Utility .....	36
3.2	VGA Driver Installation .....	38
3.3	HD Audio Driver Installation .....	40
3.4	Intel® ME Drivers Installation .....	41
3.5	LAN Driver Installation .....	43
<b>Chapter 4</b>	<b>BIOS Setup .....</b>	<b>45</b>
4.1	Introduction .....	46
4.2	BIOS Setup .....	46
4.3	Main Settings .....	47
4.4	Advanced Settings .....	48
4.5	Chipset Settings .....	61
4.6	Security Settings .....	63
4.7	Boot Settings .....	65
4.8	Save & Exit Settings .....	66

<b>Appendix .....</b>	<b>67</b>
A. I/O Port Address Map .....	68
B. Interrupt Request Lines (IRQ).....	70
C. Watchdog Timer Configuration .....	71
D. Onboard Connector Reference Types.....	75

This page is intentionally left blank.

# Chapter 1

## General Information

The information provided in this chapter includes:

- Features
- Packing List
- Optional Accessories
- Specifications
- Block Diagram
- Product View
- Board Dimensions

## 1.1 Introduction

The IB836 is a 3.5-inch single board computer powered by robust Intel® Atom® / Pentium or Celeron processors to meet the demands of critical real-time computing in applications spanning the retail, transport, industrial automation, and medical sectors. The SBC has two DDR4 memory slots with a 32GB capacity and in-band error-correcting code (IBECC) functionality that corrects single-bit memory errors in standard, non-ECC memory. Three independent displays can be driven with up to 4Kp60 resolutions via two DisplayPort (DP & Type C) and one eDP or LVDS output. Rich I/O connectivity and expansion capabilities allow connection to numerous peripherals and include 2x USB 2.0, 4x USB 3.1, 2x SATA III, 1x M.2 and 1x mPCIe interface, as well as three Gigabit Ethernet ports. Measuring 102mm by 147mm, the board operates on a 9V~36V wide range power input.

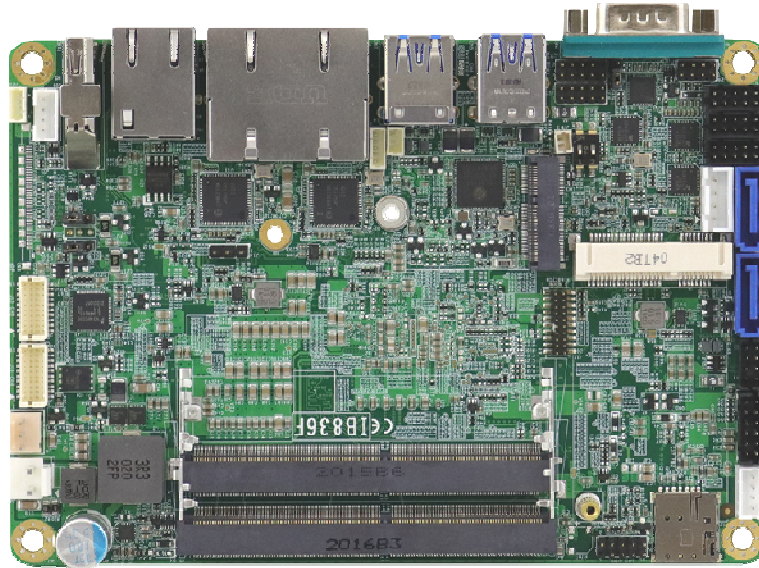

**IB836 3.5" disk-size SBC**



## 1.2 Features

- 3.5" disk-size SBC with Intel® 8<sup>th</sup> Gen. Core™ U-series or Celeron® processor
- 2 x DDR4-3200 SO-DIMM slots, expandable up to 32 GB
- Video output through LVDS or EDP connector, Display Port, and USB Type C
- 3 x GbE LAN ports, 2 x USB 2.0, 4 x USB 3.0, 4 x COM, 2 x SATAIII, 1 x M.2 (E-Key), 1x mPCIe slot (full-size)
- Configurable watchdog timer, digital I/O, TPM 2.0

### 1.3 Packing List

Your IB836 package should include the items listed below. If any of the items below is missing, contact the distributor or dealer from whom you purchased the product.

- IB836 SBC x 1
- Disk (including chipset drivers and flash memory utility) x 1
- This User's Manual x 1

### 1.4 Optional Accessories

IBASE provides optional accessories as follows. Please contact us or your dealer if you need any.

- Cable Kit (IB76A-2)
  - Including:
  - DC-In Power Cable (PW592) x 1
  - COM Ports Cable (PK1H) x 1
  - SATA & HDD Power Cable (SATA-53A) x 1
  - USB 2.0 Cable (USB-29) x 1
- Audio cable (Audio-18)
- Heat Spreader (HSIB836-X-1) for Atom series
- Heat Sink (HSIB836-X-B) for Atom series
- Heat Spreader (HSIB836-1) for Celeron / Pentium
- Heat Sink (HSIB836-B) for Celeron / Pentium

## 1.5 Specifications

Model	IB836F(E)-6425E	IB836F(E)-6413E	IB836F(E)-6211E	IB836F(E)-J6413E	IB836F(E)-N6210
	Remarks: IB836F: for LVDS only; IB836FE: for eDP only				
Form Factor	3.5" disk-size SBC				
CPU Type	Atom® 4C/ x6425E	Atom® 4C/ x6413E	Atom® 2C/ x6211E	Celeron® 4C/ J6413	Celeron® 4C/ N6210
CPU Speed	1.8GHz 3.0GHz	1.5GHz 3.0GHz	1.2GHz 3.0GHz	1.8GHz 3.0GHz	1.2GHz 2.6GHz
Cache	1.5MB	1.5MB	1.5MB	1.5MB	1.5MB
Chipset	Integrated in Intel® SoC				
Memory	2x DDR4-3200 SO-DIMM, Max. 32GB, supports IB ECC				
Storage	1x mSATA (shared with SATA port)				
Graphics	Intel® SoC integrated Gen11 Graphics				
LAN	3x Intel® I210IT PCI-E GbE			3x Intel® I211AT PCI-E GbE	
Super I/O	Fintek F81964D-I				
Audio Codec Controller	Built-in HD with Realtek ALC269 w/ class-D amplifier				
Power Requirement	9V ~ 36V DC-In				
USB Type C	USB 3.1 (Gen.2)				
TPM	2.0				
Watchdog Timer	Yes (256 segments, 0, 1, 2...255 sec / min)				
BIOS	AMI BIOS				
H/W Monitor	Yes				
Dimensions	102.22 x 147.01 mm (4.02" x 5.8")				
RoHS	Yes				
Certification	CE, FCC Class B				
Operating System	<ul style="list-style-type: none"> <li>Windows 10</li> <li>Linux Ubuntu</li> </ul>				

Model	IB836F(E)-6425E	IB836F(E)-6413E	IB836F(E)-6211E	IB836F(E)-J6413E	IB836F(E)-N6210
<b>I/O Ports</b>					
<b>Display</b>	2x DisplayPort (DP connector & Type-C), eDP or 24-bit dual-channel LVDS				
<b>LAN</b>	2 x RJ45 GbE LAN				
<b>USB</b>	<ul style="list-style-type: none"> <li>• 2x USB2.0 (Pin-header)</li> <li>• 3x USB3.1 (Type-A), 1x USB Type-C</li> </ul>				
<b>Serial</b>	<ul style="list-style-type: none"> <li>• 1x RS232/422/485 (Jumperless selection)</li> <li>• 3x RS232</li> </ul>				
<b>SATA</b>	2 x SATA III				
<b>Audio</b>	On-board audio connector for Line-In, Line-Out, and Mic-In				
<b>Digital IO</b>	4-In & 4-Out				
<b>Expansion Slots</b>	1x M.2 (E-Key, type:2230)				
<b>Environment</b>					
<b>Temperature</b>	Operating: -40°C ~ 85 °C (40 ~ 185 °F)		Operating: 0°C ~ 60 °C (32 ~ 140 °F)		
	Storage: -40°C ~ 110 °C (-40 ~ 230 °F)		Storage: -20°C ~ 80 °C (-4 ~ 176 °F)		
<b>Relative Humidity</b>	0 ~ 90 %, non-condensing at 60 °C				

All specifications are subject to change without prior notice.

## 1.6 Block Diagram

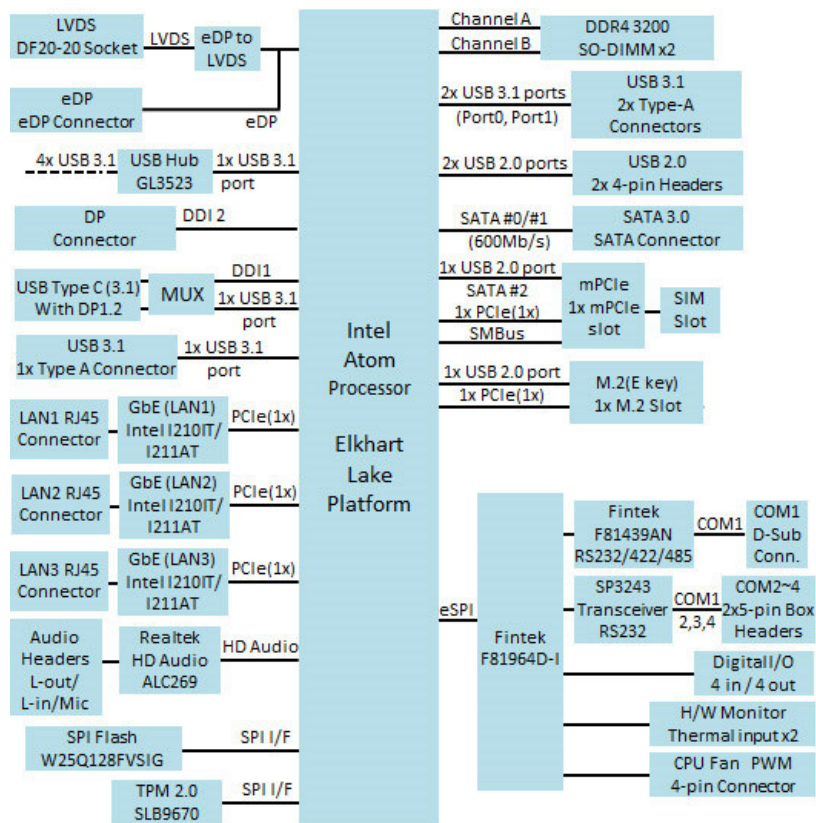

## 1.7 Product View

### Top View

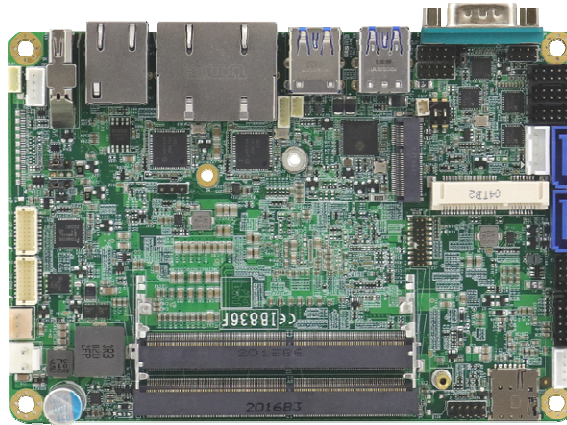

### Bottom View

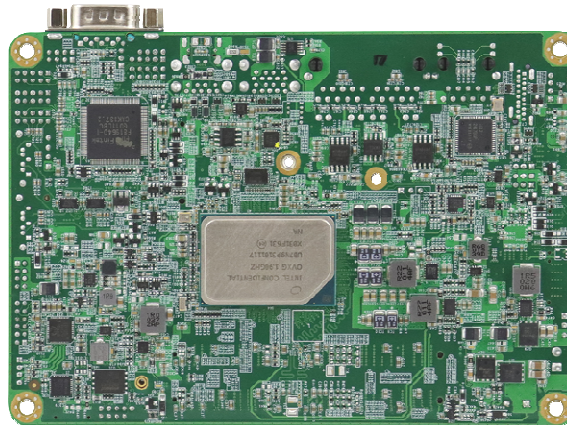

**Photos of IB836**

\* The photos above are for reference only. Some minor components may differ.

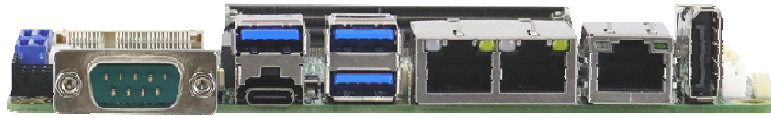
**I/O View****Edge connectors (from left to right)**

CN4	COM1 RS-232/422/485 Port
CN5	Type-C Connector
CN6, CN7	USB3.0 Connector
CN8	LAN Connector
CN9	LAN Connector
CN10	DP Connector

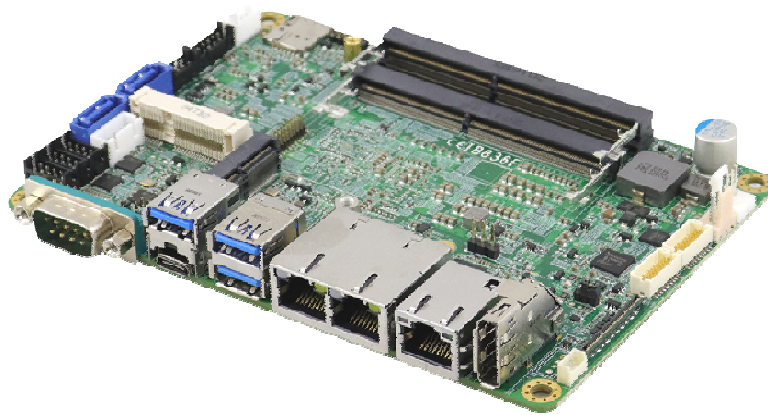
**Oblique View**

## 1.8 Dimensions

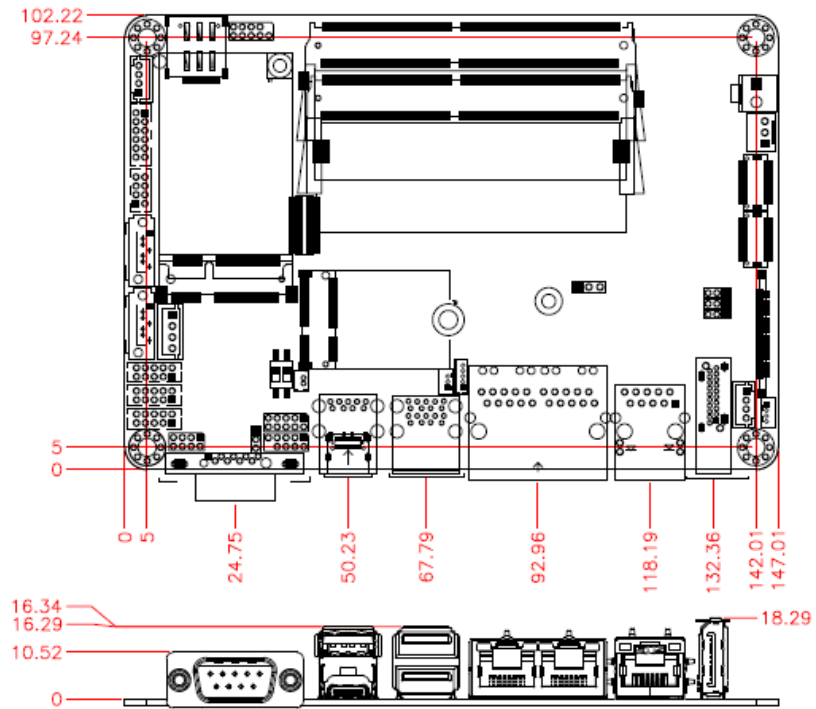



## Chapter 2

# Hardware Configuration

This section provides information on jumper settings and connectors on the IB836 in order to set up a workable system. On top of that, you will also need to install crucial pieces such as the CPU and the memory before using the product. The topics covered are:

- Essential installations before you begin
- Jumper and connector locations
- Jumper settings and information of connectors

## 2.1 Essential Installations

Follow the instructions below to install the memory.

### 2.1.1 Installing the Memory

The IB836 series supports two DDR4 memory sockets for a maximum total memory of 32 GB. To install the modules, locate the memory slot on the board and perform the following steps:

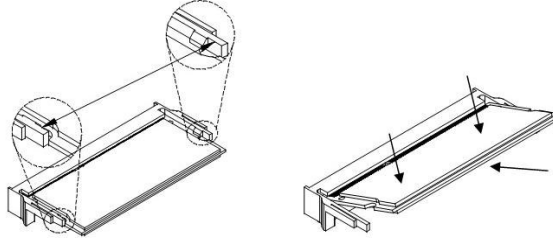

1. Align the key of the memory module with that on the memory slot and insert the module slantwise.
2. Gently push the module in an upright position until the clips of the slot close to hold the module in place when the module touches the bottom of the slot.

To remove the module, press the clips outwards with both hands, and the module will pop-up.

## 2.2 Setting the Jumpers

Set up and configure your IB836 by using jumpers for various settings and features according to your needs and applications. Contact your supplier if you have doubts about the best configuration for your use.

### 2.2.1 How to Set Jumpers

Jumpers are short-length conductors consisting of several metal pins with a non-conductive base mounted on the circuit board. Jumper caps are used to have the functions and features enabled or disabled. If a jumper has 3 pins, you can connect either PIN1 to PIN2 or PIN2 to PIN3 by shorting.

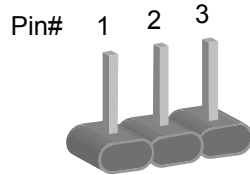

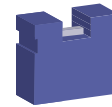

A 3-pin jumper

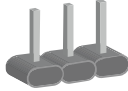
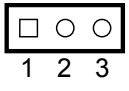
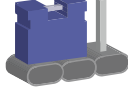
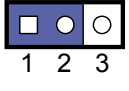

A jumper cap

Refer to the illustration below to set jumpers.

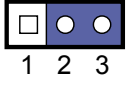
Pin closed	Oblique view	Schematic illustration in the manual
Open		
1-2		
2-3		

When two pins of a jumper are encased in a jumper cap, this jumper is **closed**, i.e. turned **On**.

When a jumper cap is removed from two jumper pins, this jumper is **open**, i.e. turned **Off**.

### 2.3 Jumper & Connector Locations

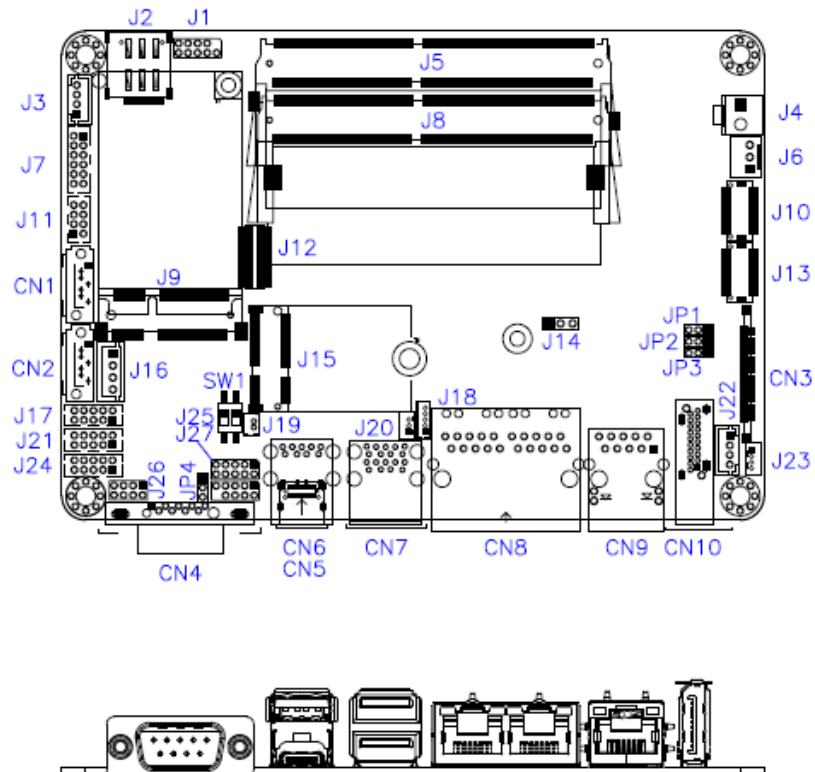

## 2.4 Jumpers Quick Reference

Jumper / Switch	Function
SW1	Clear CMOS Data
SW1	Clear ME Register
JP2	EDP Panel Power Select
JP1	LVDS Panel Power Select
JP3	LVDS Panel Brightness Select
JP4	ATX / AT Power Select

### 2.4.1 Clear CMOS Data (SW1)

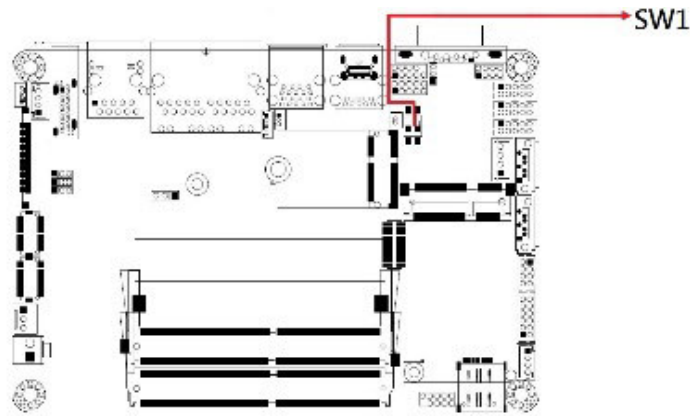

Function	Setting
Normal (default)	P1-OFF
Clear CMOS	P1-ON

**2.4.2 Clear ME Register (SW1)**

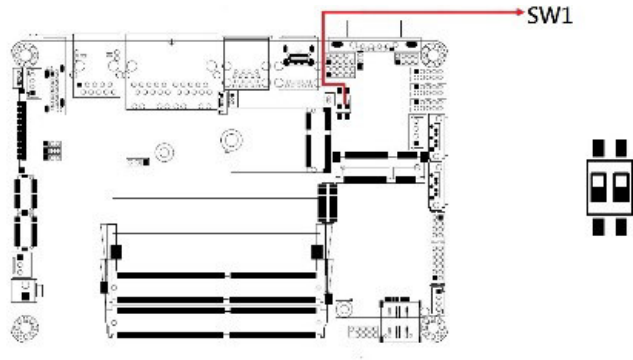

Function	Setting
Normal (default)	P2-OFF
Clear ME	P2-ON

**2.4.3 EDP Panel Power Selections (JP2)**

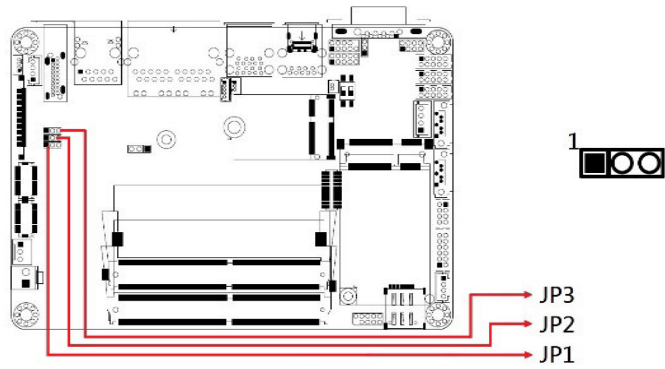

Function	Pin closed	Illustration
3.3V (default)	1-2	1
5V	2-3	1

### 2.4.4 LVDS Panel Power Selection (JP1)

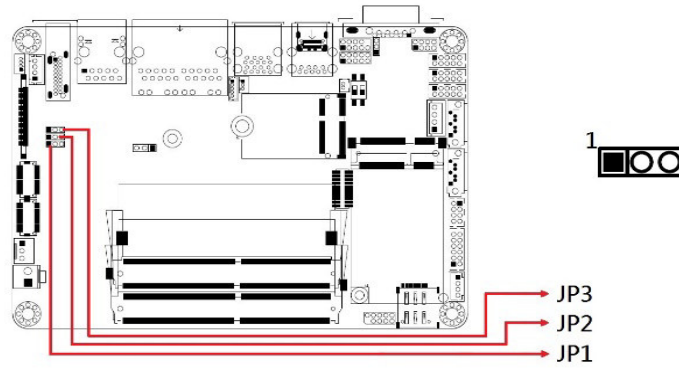

Function	Pin closed	Illustration
3.3V (default)	1-2	1
5V	2-3	1

### 2.4.5 LVDS Panel Brightness Selection (JP3)

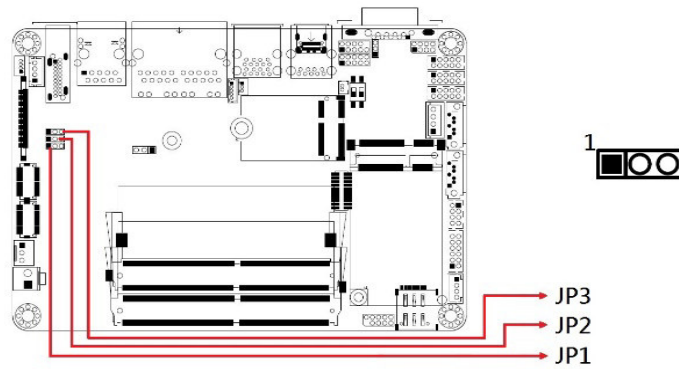

Function	Pin closed	Illustration
3.3V (default)	1-2	1
5V	2-3	1

**2.4.6 ATX / AT Power Selection (JP4)**

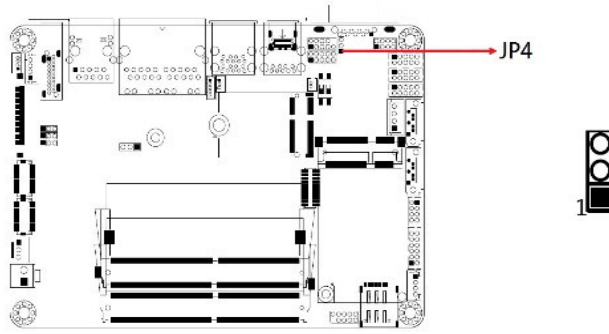

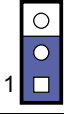
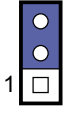
Function	Pin closed	Illustration
ATX (default)	1-2	
AT	2-3	



## 2.5 Connectors Quick Reference

Connector	Function
J2	SIM Card Slot
J3	Amplifier Connector
J4	DC Power Input Connector
J5, J8	DDR4 Slots
J16	SATA HDD Power Connector
J6	Fan Power Connector
J7	Audio Connector
J9	Mini PCIE Connector
J10, J13	LVDS Connector
J11	USB 2.0 Connector
J19	Battery Connector
J22	LCD Backlight Connector
J23	SMBUS Connector
J24, J21, J17	COM2, COM3, COM4 RS-232 Ports
J25	Digital I/O Connector
J26	Front Panel Connector
CN1,CN2	SATA Connectors
CN3	EDP Connector
CN4	COM1 RS-232/422/485 Port
CN5	Type-C Connector
CN6, CN7	USB3.0 Connector
CN8	LAN Connector
CN9	LAN Connector
CN10	DP Connector

**2.5.1 COM1 RS-232/422/485 Port (CN4)**

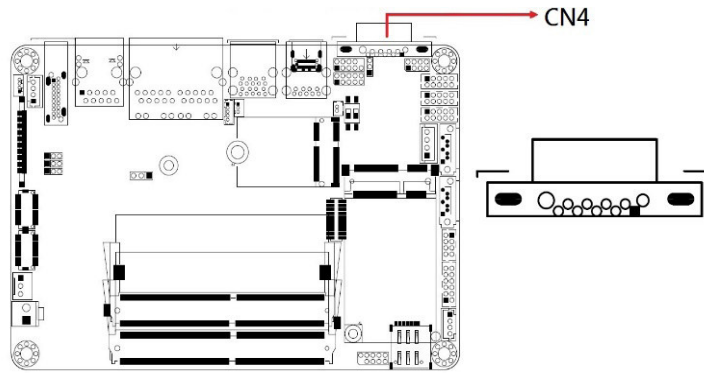

COM1 port is jumper-less and configurable in BIOS.

Pin	Assignment	Pin	Assignment
1	DSR, Data set ready	6	DCD, Data carrier detect
2	Ground	7	DTR, Data terminal ready
3	Ground	8	CTS, Clear to send
4	TX, Transmit	9	RTS, Request to send
5	RX, Receive	10	RI, Ring Indicator

Pin	Assignment		
	RS-232	RS-422	RS-485
1	DSR	NC	NC
2	Ground	Ground	Ground
3	Ground	Ground	Ground
4	TX	RX+	NC
5	RX	TX+	Data+
6	DCD	TX-	Data-
7	DTR	RX-	NC
8	CTS	NC	NC
9	RTS	NC	NC
10	RI	NC	NC

### 2.5.2 Amplifier Connector (J3)

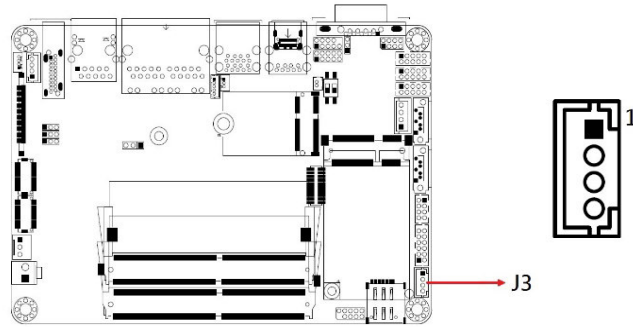

Pin	Assignment	Pin	Assignment
1	SPK_L+	3	SPK_R-
2	SPK_L-	4	SPK_R+

### 2.5.3 Audio Connector (J7)

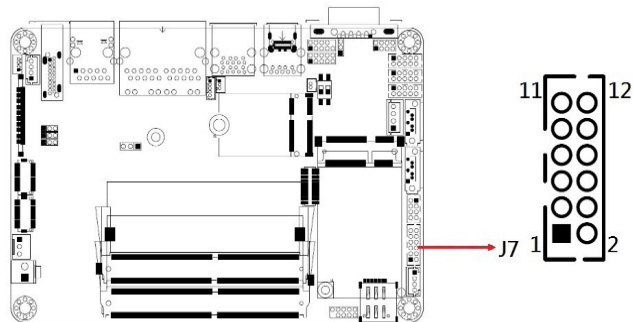

Pin	Assignment	Pin	Assignment
1	Lineout_L	2	Lineout_R
3	JD_FRONT	4	Ground
5	LINEIN_L	6	Linein_R
7	JD_LINEIN	8	Ground
9	MIC_L	10	MIC-R
11	JD_MIC1	12	Ground

**2.5.4 SATA HDD Power Connector (J16)**

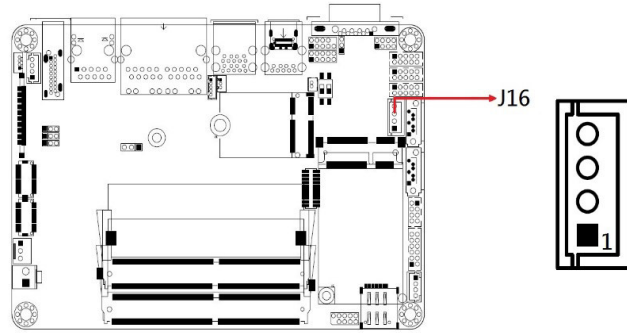

Pin	Assignment	Pin	Assignment
1	+5V	3	Ground
2	Ground	4	+12V

**2.5.5 Front Panel Connector (J26)**

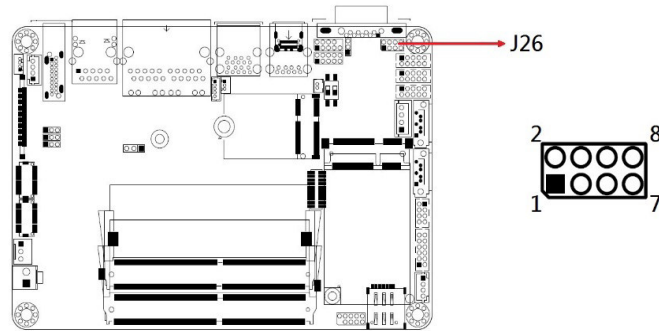

Pin	Assignment	Pin	Assignment
1	Ground	2	PWR_BTN
3	3.3V	4	HDD Active
5	Ground	6	Reset
7	+5V	8	Ground

J26 is utilized for system indicators to provide light indication of the computer activities and switches to change the computer status. It provides interfaces for the following functions.

- **ATX Power ON Switch (Pins 1 and 2)**  
The 2 pins makes an “ATX Power Supply On/Off Switch” for the system that connects to the power switch on the case. When pressed, the power switch will force the system to power on. When pressed again, it will power off the system.
- **Hard Disk Drive LED Connector (Pins 3 and 4)**  
This connector connects to the hard drive activity LED on control panel. This LED will flash when the HDD is being accessed.
- **Reset Switch (Pins 5 and 6)**  
The reset switch allows you to reset the system without turning the main power switch off and then on again. Orientation is not required when making a connection to this header.
- **Power LED: Pins 7 and 8**  
This connector connects to the system power LED on control panel. This LED will light when the system turns on.

**2.5.6 USB 2.0 Connector (J11)**

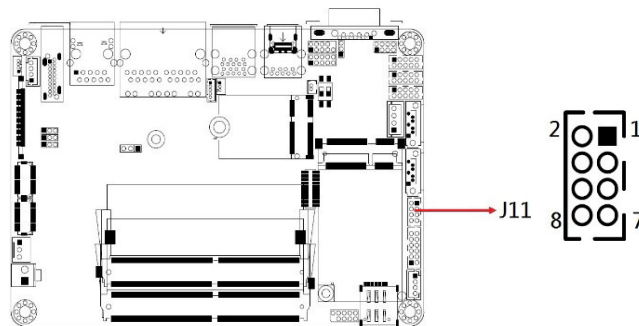

Pin	Assignment	Pin	Assignment
1	VCC	2	Ground
3	D0-	4	D1+
5	D0+	6	D1-
7	Ground	8	VCC

**2.5.7 Battery Connector (J19)**

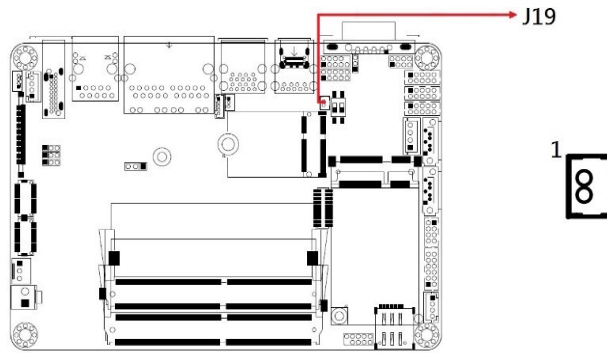

Pin	Assignment
1	Battery+
2	Ground

**2.5.8 COM2, COM3, COM4 RS-232 Ports (J24, J21, J17)**

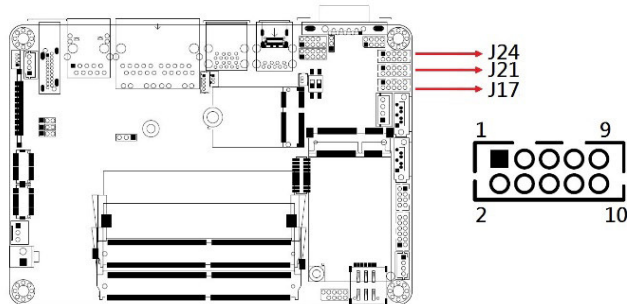

Pin	Assignment	Pin	Assignment
1	DCD, Data carrier detect	2	RXD, Receive data
3	TXD, Transmit data	4	DTR, Data terminal ready
5	Ground	6	DSR, Data set ready
7	RTS, Request to send	8	CTS, Clear to send
9	RI, Ring indicator	10	Not Used

## 2.5.9 DC Power Input Connector (J4)

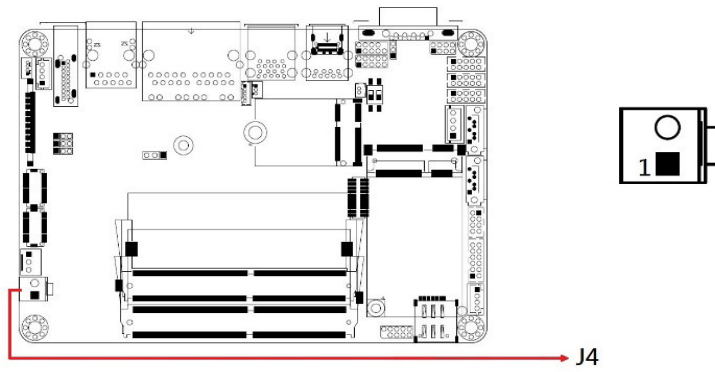

Pin	Assignment
1	+9V ~ +36V
2	Ground

**2.5.10 Digital I/O Connector (J25)**

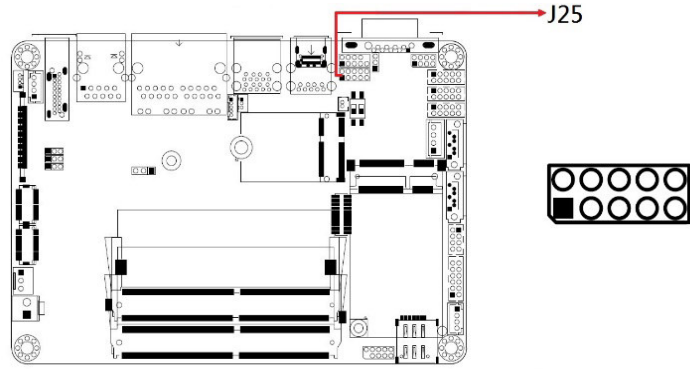

Pin	Assignment	Pin	Assignment
1	Ground	2	VCC
3	OUT3	4	OUT1
5	OUT2	6	OUT0
7	IN3	8	IN1
9	IN2	10	IN0

**2.5.11 LCD Backlight Connector (J22)**

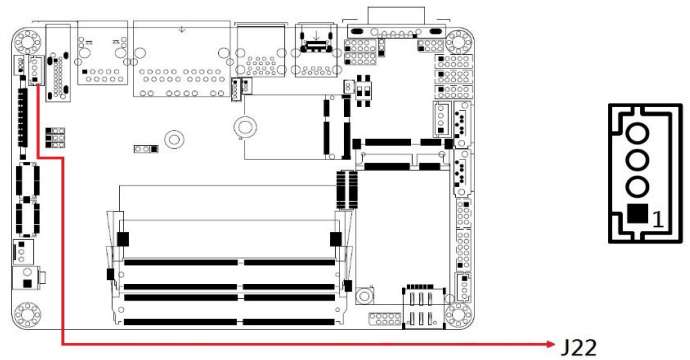

Pin	Assignment	Pin	Assignment
1	+12V	3	Brightness Control
2	Backlight Enable	4	Ground



### 2.5.12 LVDS Connector (J10, J13)

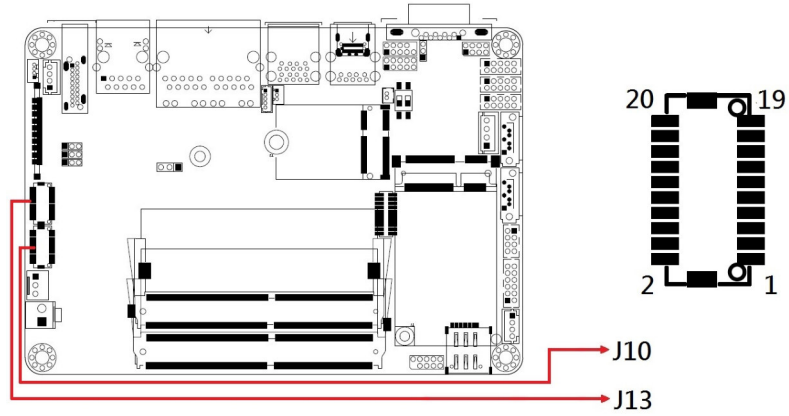

Pin	Assignment	Pin	Assignment
1	TX0P	2	TX0N
3	Ground	4	Ground
5	TX1P	6	TX1N
7	Ground	8	Ground
9	TX2P	10	TX2N
11	Ground	12	Ground
13	CLKP	14	CLKN
15	Ground	16	Ground
17	TX3P	18	TX3N
19	Power	20	Power

**2.5.13 SMBUS Connector (J23)**

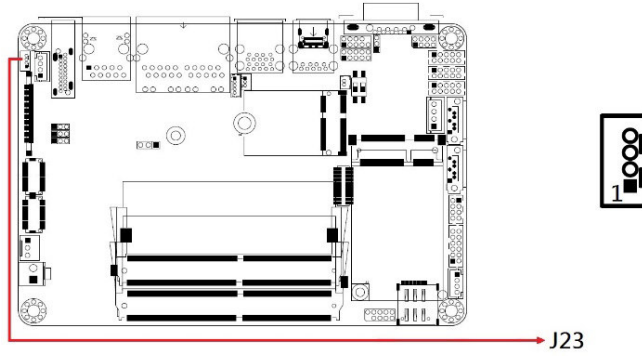

Pin	Assignment	Pin	Assignment
1	+3.3V	3	SMB_DATA
2	SMB_CLK-	4	Ground

**2.5.14 Fan Power Connector (J6)**

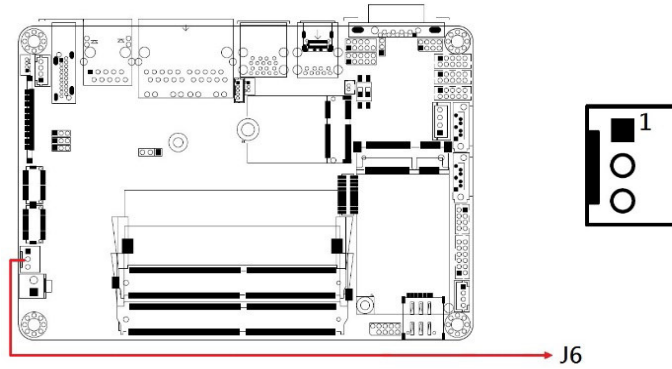

### 2.5.15 EDP Connector (CN3)

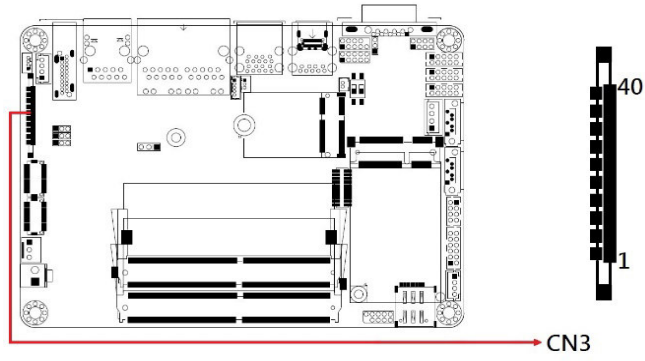

### 2.5.16 SIM Card Slot (J2)

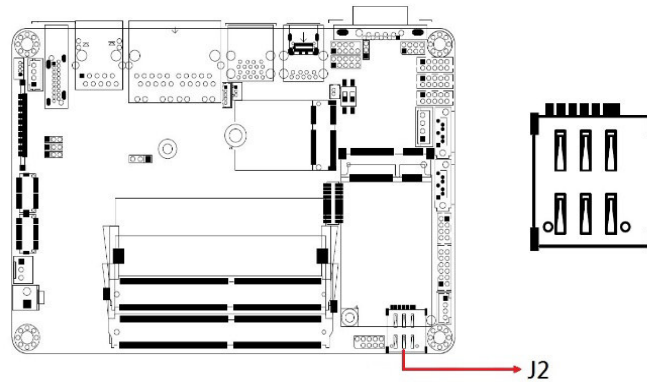

**2.5.17 SATA Connectors (CN1,CN2)**

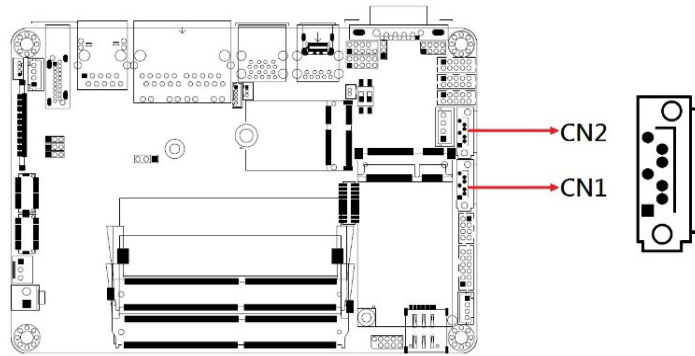

**2.5.18 23. Mini PCIE Connector (J9)**

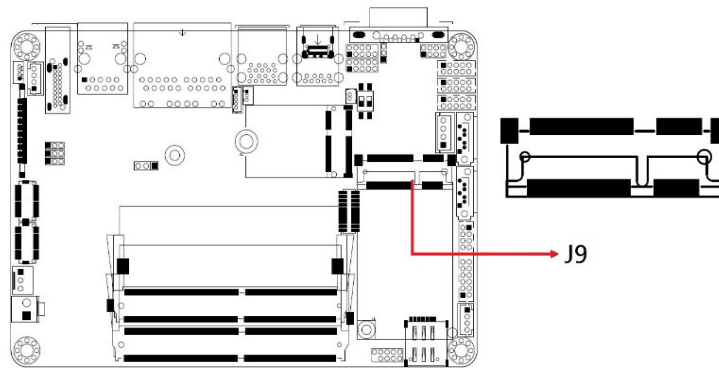

### 2.5.19 DDR4 Slot (J5)

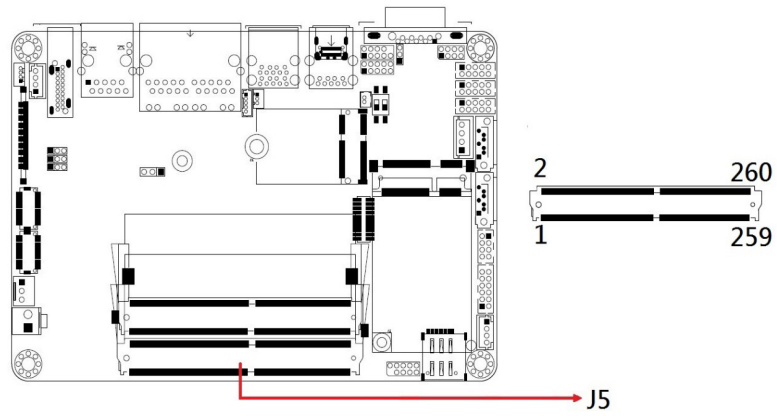

### 2.5.20 DDR4 Slot (J8)

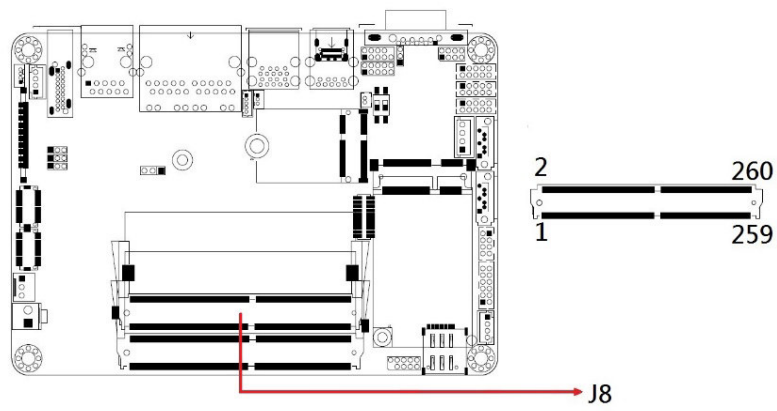

**2.5.21 DP Connector (CN10)**

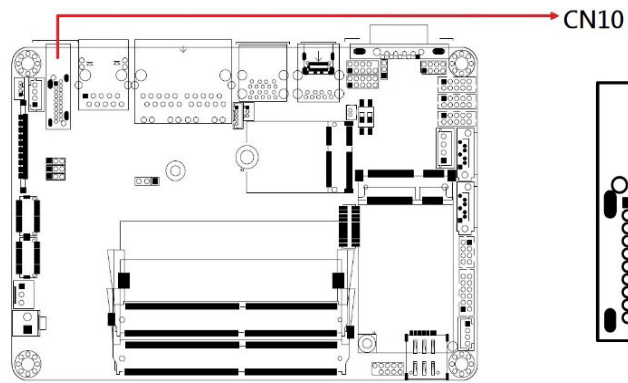

**2.5.22 LAN Connector (CN9)**

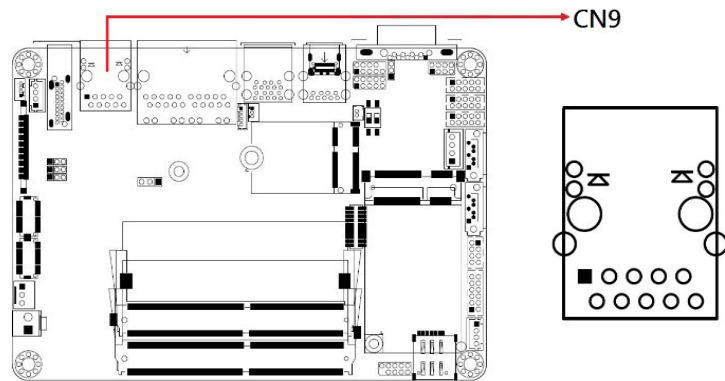

### 2.5.23 LAN Connector (CN8)

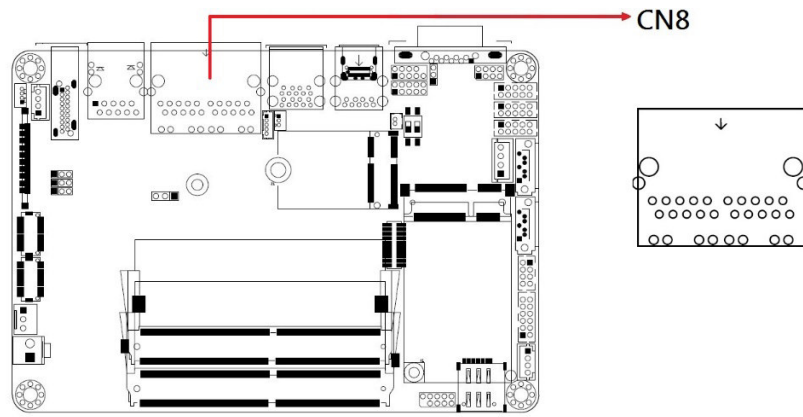

### 2.5.24 USB3.0 Connector (CN7)

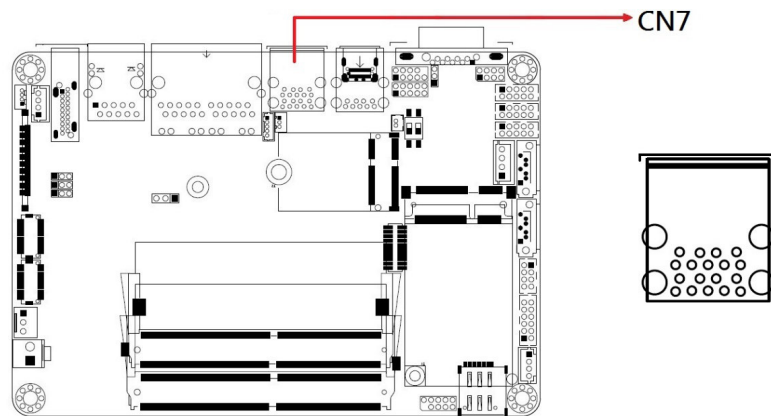

**2.5.25 USB3.0 Connector (CN6)**

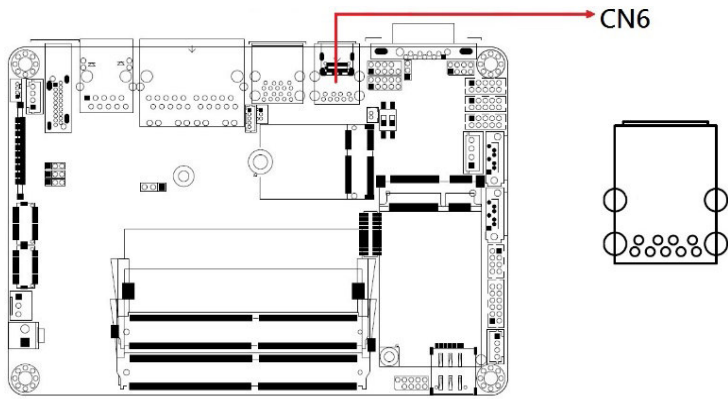

**2.5.26 Type-C Connector (CN5)**

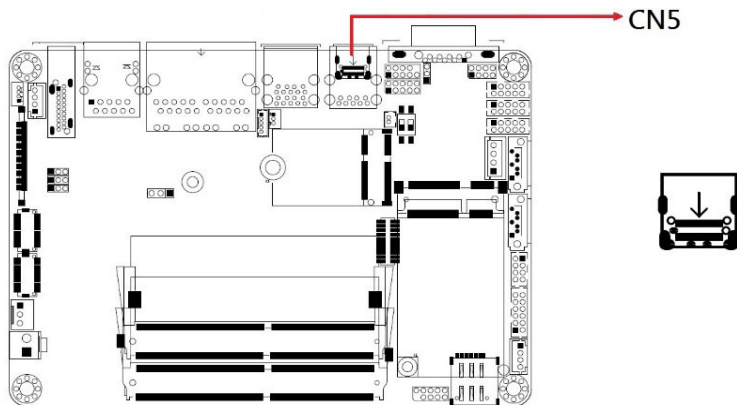



## Chapter 3

# Drivers Installation

This chapter introduces installation of the following drivers:

- Intel® Chipset Software Installation Utility
- VGA Driver
- HD Audio Driver
- LAN Driver
- Intel® Management Engine Drivers Installation

### 3.1 Intel® Chipset Software Installation Utility

---

**Note:** After installing the Windows operating system, install the Intel® Chipset Software Installation Utility first before proceeding with the drivers installation.

---

The Intel® Chipset drivers should be installed first before the software drivers to install INF files for Plug & Play function for Intel chipset components.

1. Insert the disk enclosed in the package with the board. Click **Intel** on the left pane and then **Intel(R) Elkhartlake Chipset Drivers** on the right pane.

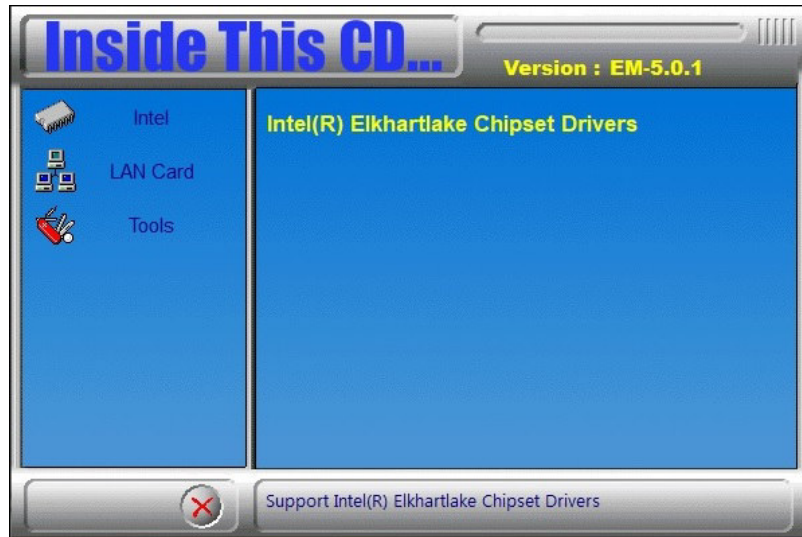

- Click **Intel(R) Chipset Software Installation Utility**.



- When the *Welcome* screen to the Intel® Chipset Device Software appears, click **Next** to continue.
- Accept the software license agreement and proceed with the installation process.
- On the *Readme File Information* screen, click **Install** for installation.
- After the installation, press **Finish** to complete the setup process.

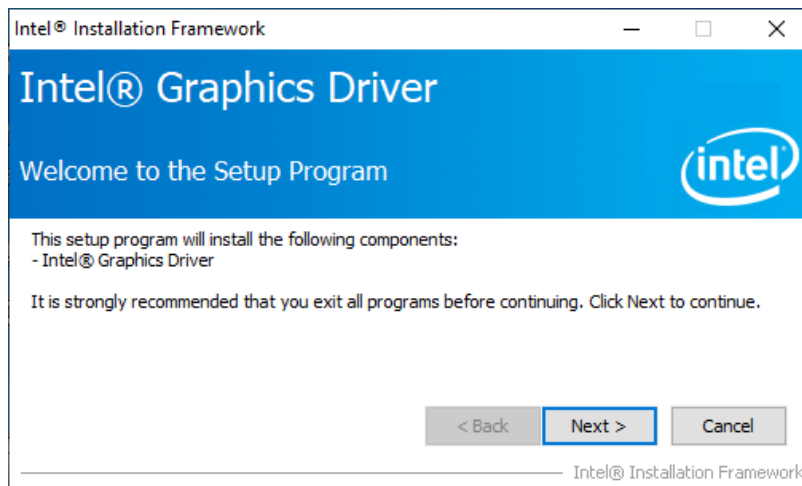

### 3.2 VGA Driver Installation

1. Insert the disk enclosed in the package with the board. Click **Intel** on the left pane and then **Intel(R) Elkhartlake Chipset Drivers** on the right pane.
2. Click **Intel(R) Elkhartlake Graphics Driver**.



3. When the *Welcome* screen appears, click **Next** to continue.

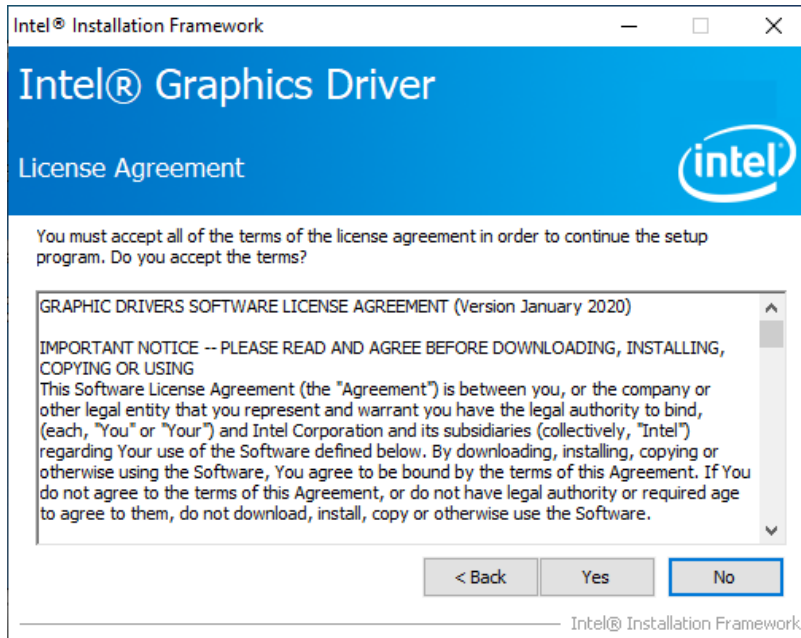

4. Click **Yes** to accept the license agreement and click **Next** in The Readme File Information screen. Click **Next** in the Setup Progress screen.

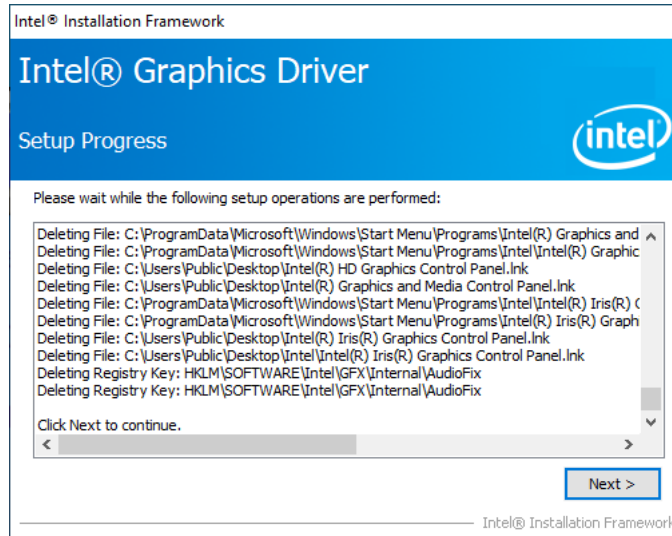

5. Restart the computer when prompted. Click **Finish**, then remove any installation media from the drives.

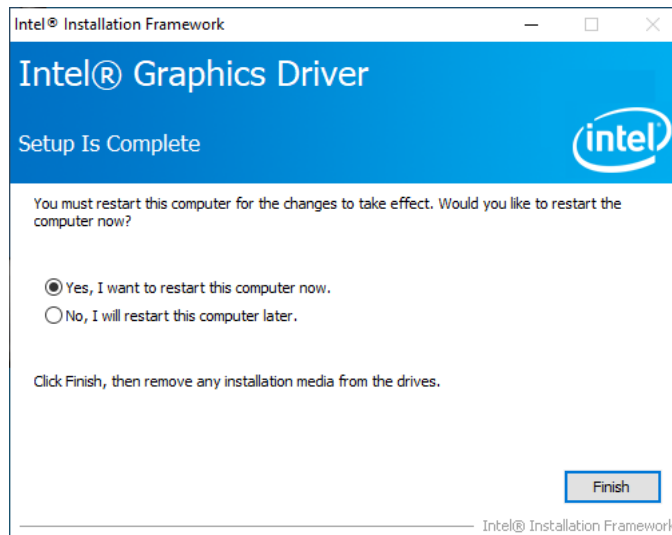

### 3.3 HD Audio Driver Installation

1. Insert the disk enclosed in the package with the board. Click Intel on the left pane and then **Intel(R) Elkhartlake Chipset Drivers** on the right pane.
2. Click **Realtek High Definition Audio Driver**.



3. On the Welcome screen, click **Next** to continue.

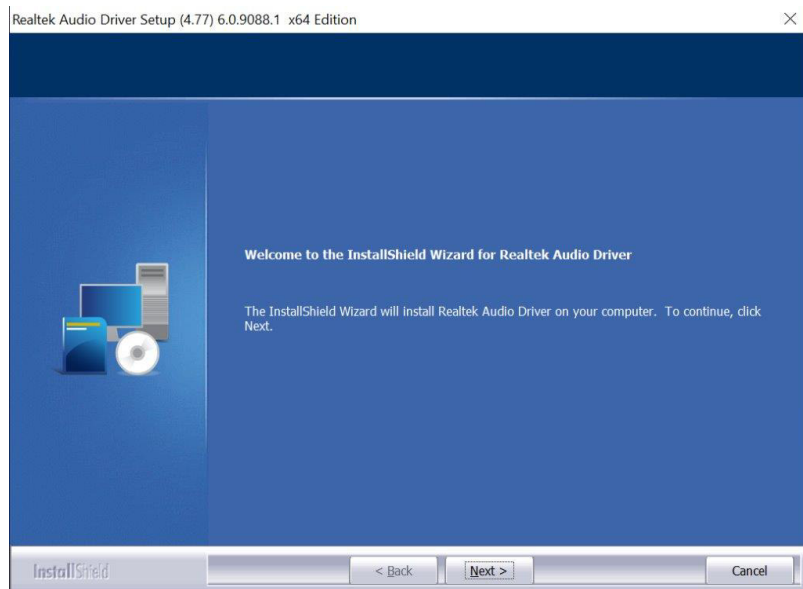

4. When the InstallShield Wizard has successfully installed the Realtek Audio Driver, restart the computer. Click **Finish** to complete the setup.

### 3.4 Intel® ME Drivers Installation

1. Insert the disk enclosed in the package with the board. Click Intel on the left pane and then **Intel(R) ME Drivers**.



2. The welcome screen to the Intel® Management Engine Components appears. Click **Next** to continue.

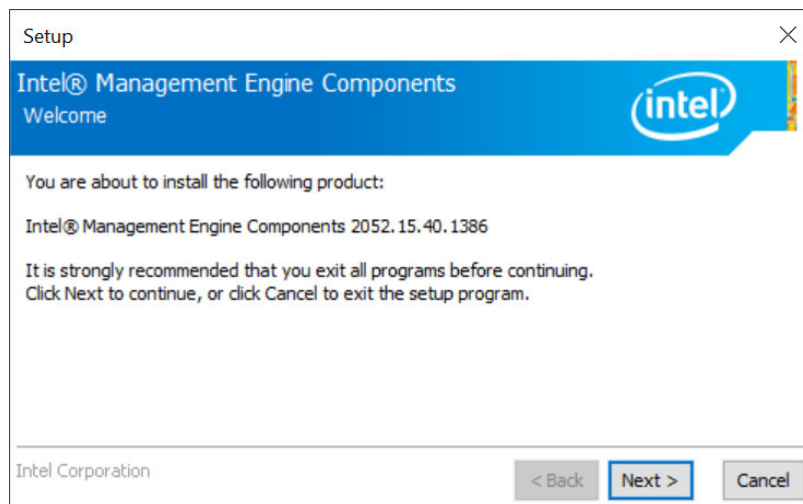

3. Accept the license agreement and click **Next**.

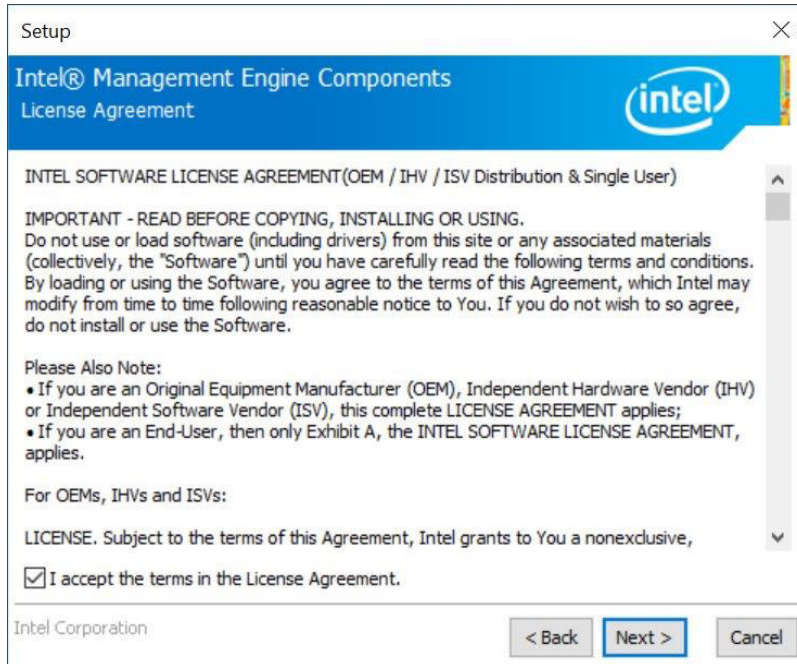

4. On the *Setup's Destination Folder* screen, click **Next** to continue.

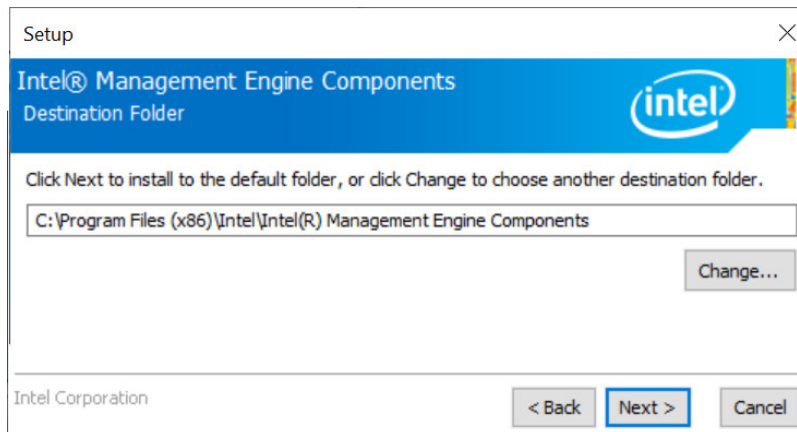

5. After the Intel® components have been completely installed, click **Finish**.



### 3.5 LAN Driver Installation

1. Insert the disk enclosed in the package with the board. Click **LAN Card** on the left pane and then **Intel LAN Controller Drivers** on the right pane.



2. Choose **Intel(R) I21x Gigabit Network Drivers**.



3. In the welcome screen to the install wizard for Intel(R) Network Connections, click **Next**.
4. On the next screen, accept the terms in the license agreement and click **Next**.

5. In the *Setup Options* screen, click **Next**.

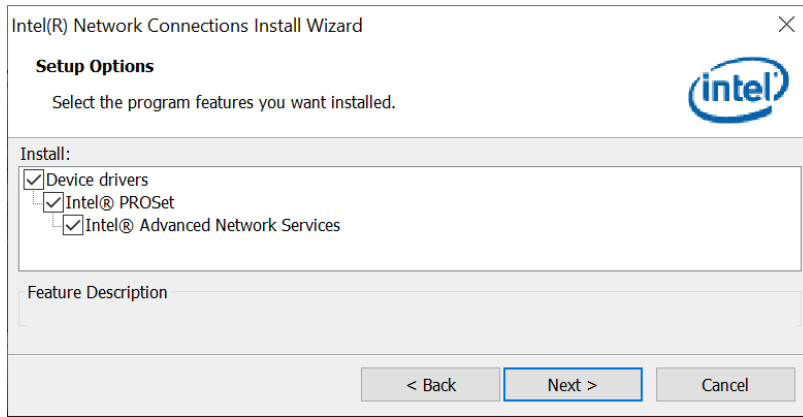

6. Click **install** to begin the installation.

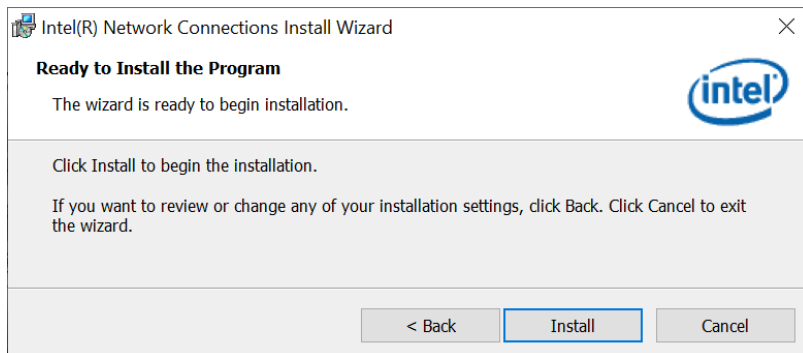

7. Click **Finish** when Install wizard has completed.

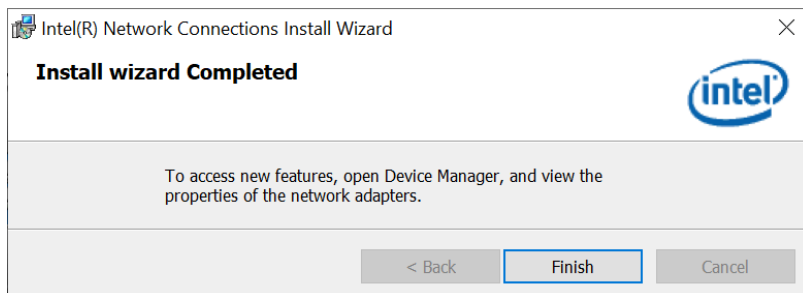

## Chapter 4

# BIOS Setup

This chapter describes the different settings available in the AMI BIOS that comes with the board. The topics covered in this chapter are as follows:

- Main Settings
- Advanced Settings
- Chipset Settings
- Security Settings
- Boot Settings
- Save & Exit

## 4.1 Introduction

The BIOS (Basic Input/Output System) installed in the ROM of your computer system supports Intel® processors. The BIOS provides critical low-level support for standard devices such as disk drives, serial ports and parallel ports. It also provides password protection as well as special support for detailed fine-tuning of the chipset controlling the entire system.

## 4.2 BIOS Setup

The BIOS provides a Setup utility program for specifying the system configurations and settings. The BIOS ROM of the system stores the Setup utility. When you turn on the computer, the BIOS is immediately activated. Press the <Del> key immediately allows you to enter the Setup utility. If you are a little bit late pressing the <Del> key, POST (Power On Self Test) will continue with its test routines, thus preventing you from invoking the Setup.

If you still need to enter Setup, restart the system by pressing the "Reset" button or simultaneously pressing the <Ctrl>, <Alt> and <Delete> keys. You can also restart by turning the system Off and back On again.

The following message will appear on the screen:

```
Press <DEL> to Enter Setup
```

In general, press the arrow keys to highlight items, <Enter> to select, the <PgUp> and <PgDn> keys to change entries, <F1> for help, and <Esc> to quit.

When you enter the BIOS Setup utility, the *Main Menu* screen will appear on the screen. The Main Menu allows you to select from various setup functions and exit choices.

---

**Warning:** It is strongly recommended that you avoid making any changes to the chipset defaults.

These defaults have been carefully chosen by both AMI and your system manufacturer to provide the absolute maximum performance and reliability. Changing the defaults could make the system unstable and crash in some cases.

---

### 4.3 Main Settings

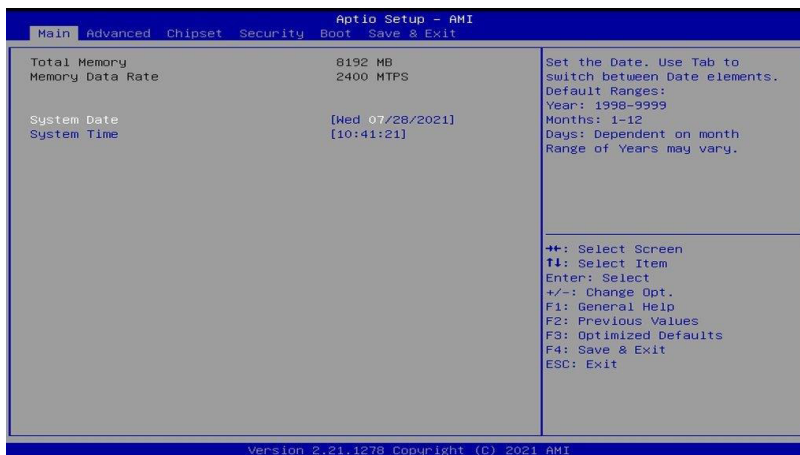

BIOS Setting	Description
System Date	Sets the date. Use the <Tab> key to switch between the data elements.
System Time	Set the time. Use the <Tab> key to switch between the data elements.

## 4.4 Advanced Settings

This section allows you to configure, improve your system and allows you to set up some system features according to your preference.

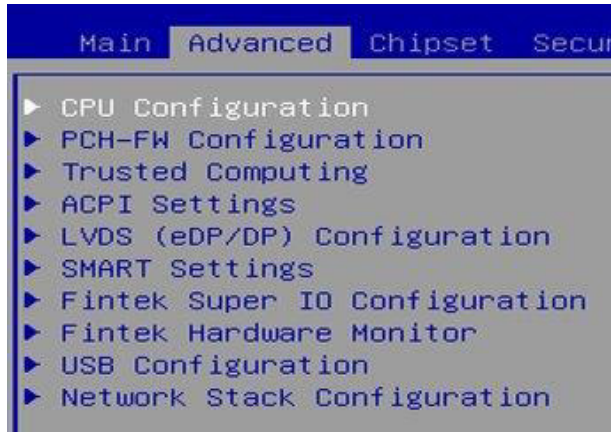

### 4.4.1 CPU Configuration

Displays CPU configuration parameters.

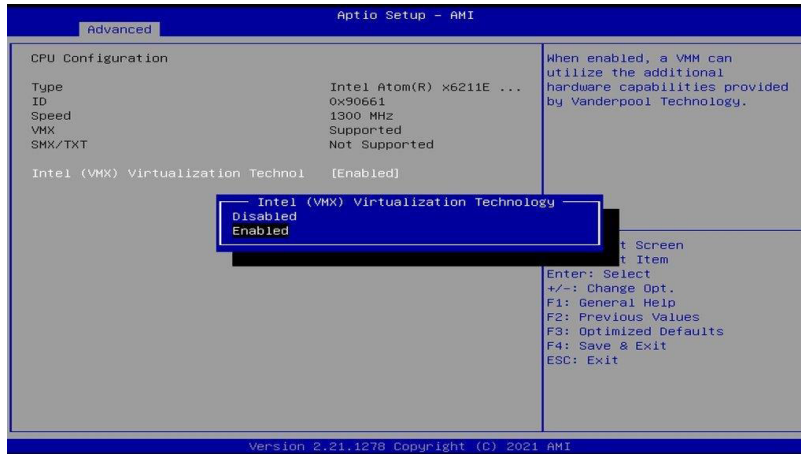

### 4.4.2 PCH-FW Configuration

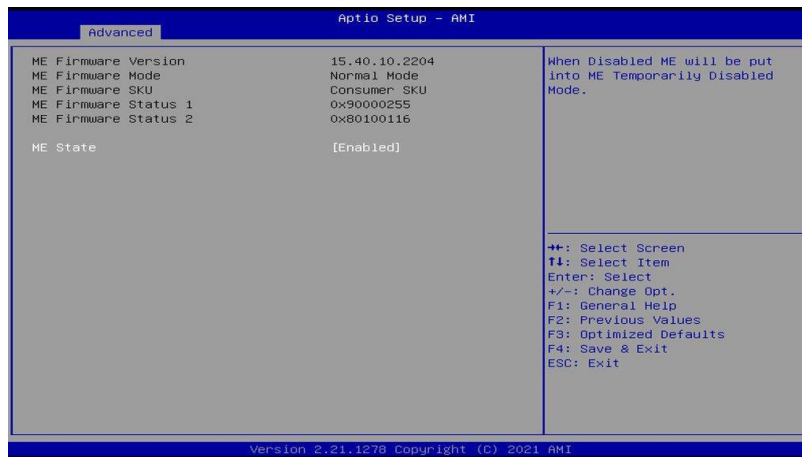

BIOS Setting	Description
ME State	When disabled ME will be put into ME Temporarily Disabled Mode.

### 4.4.3 Trusted Computing

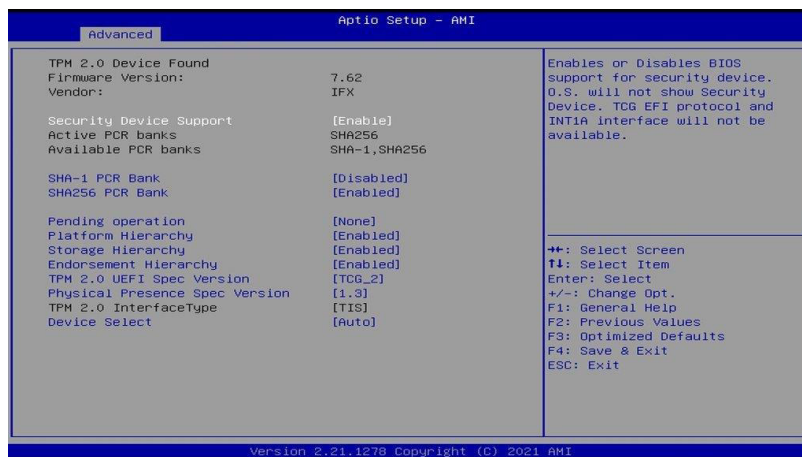

BIOS Setting	Description
Security Device Support	Enables / Disables BIOS support for security device. OS will not show security device. TCG EFI protocol and INTIA interface will not be available.
SHA-1 PCR Bank	Enables / Disables SHA-1 PCR Bank.
SHA256 PCR Bank	Enables / Disables SHA256 PCR Bank.
Pending operation	Schedule an operation for the security device.  Note: Your computer will reboot during restart in order to change state of security device.
Platform Hierarchy	Enables / Disables platform hierarchy.
Storage Hierarchy	Enables / Disables storage hierarchy.
Endorsement Hierarchy	Enables / Disables endorsement hierarchy.
TPM2.0 UEFI Spec Version	Selects the supported TCG version based o your OS. <ul style="list-style-type: none"> <li>• <b>TCG_1_2</b>: supports Windows 8 /10.</li> <li>• <b>TCG_2</b>: supports new TCG2 protocol and event format for Windows 10 or later.</li> </ul>
Physical Presence Spec Version	Selects to show the PPI Spec Version (1.2 or 1.3) that the OS supports.  <b>Note:</b> Some HCK tests might not support 1.3.
Device Select	<ul style="list-style-type: none"> <li>• <b>TPM 1.2</b> will restrict support to TPM 1.2 devices only.</li> <li>• <b>TPM 2.0</b> will restrict support to TPM 2.0 devices only.</li> <li>• <b>Auto</b> will support both with the default being set to TPM 2.0 deices if not found, and TPM 1.2 device will be enumerated.</li> </ul>



## 4.4.4 ACPI Settings

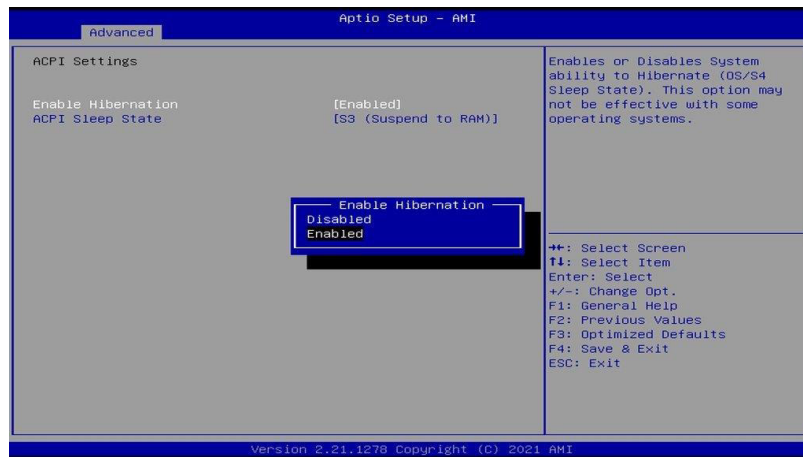

BIOS Setting	Description
Enable Hibernation	Enables / Disables the system ability to hibernate (OS/S4 Sleep State). This option may be not effective with some OS.
ACPI Sleep State	Selects an ACPI sleep state (Suspend Disabled or S3) where the system will enter when the Suspend button is pressed.

**4.4.5 LVDS (eDP/DP) Configuration**



BIOS Setting	Description
LVDS (eDP/DP) Support	Enables / Disables LVDS (eDP/DP).
Panel Color Depth	Selects the panel color depth. Options: 18 bit, 24 Bit (VESA), 24 bit (JEIDA)
LVDS Channel Type	Chooses the LVDS as single or dual channel.
LCD Panel Type	Selects LCD panel used by Intel Graphics Device by selecting the appropriate setup item.  Resolution Options: VBIOS Default, 800 x 480, 800 x 600, 1024 x 768, 1280 x 800, 1280 x 1024, 1366 x 768, 1440 x 900, 1600 x 900, 1680 x 1050, 1920 x 1080, 1920 x 1200
LVDS Brightness Level Control	Options: Level-1 to Level-8

#### 4.4.6 SMART Settings

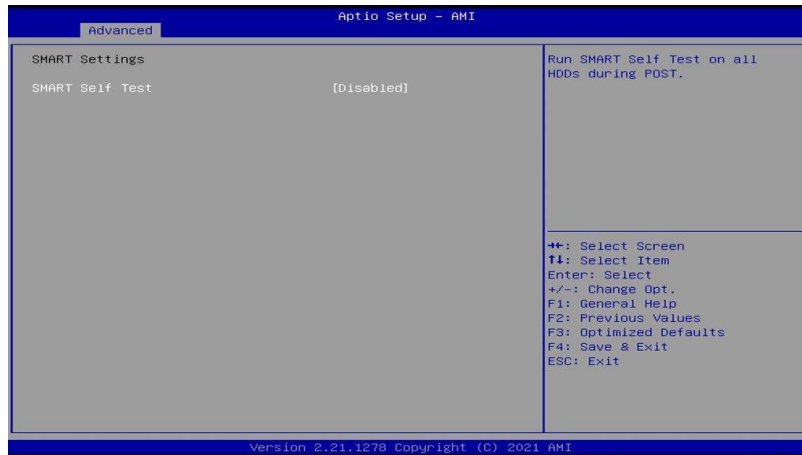

#### 4.4.7 F81846 Super IO Configuration

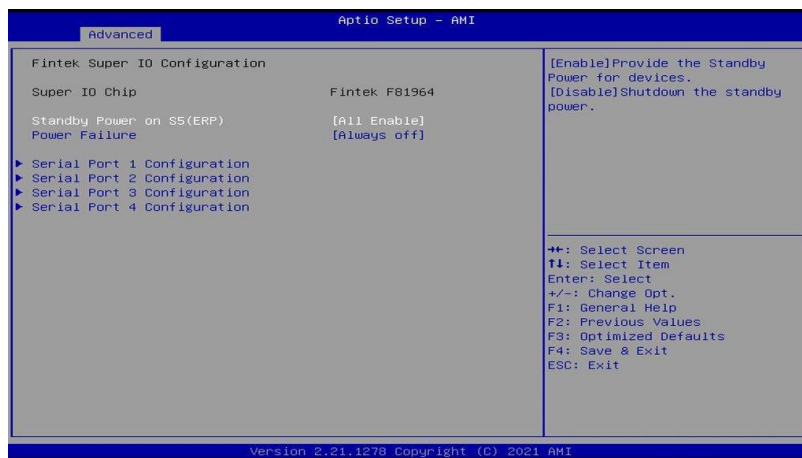

BIOS Setting	Description
Standby Power on S5(ERP)	This setting enables or shutdown the standby power for devices.
Power Failure	Options: Always on, Always off
Serial Ports Configuration	Sets parameters of serial ports. Enables / Disables the serial port and select an optimal setting for the Super IO device.

**Serial Port 1 Configuration**

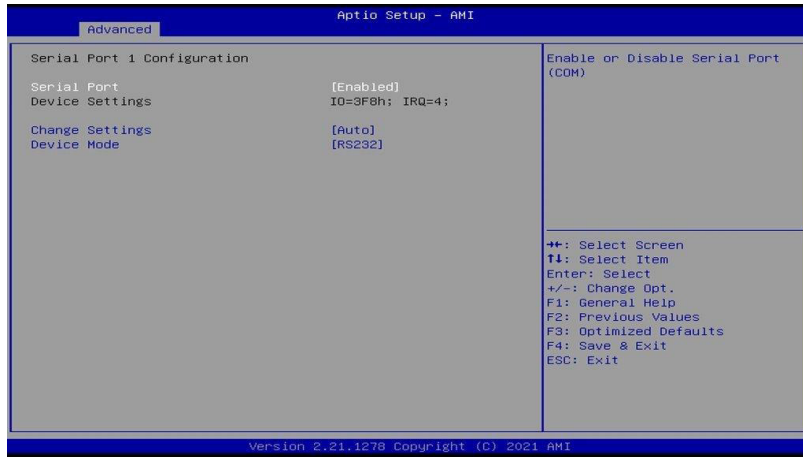

BIOS Setting	Description
Serial Port	Enables / Disables the serial port.
Change Settings	Selects an optimal settings for Super I/O device. Options: <ul style="list-style-type: none"> <li>• Auto</li> <li>• IO = 3F8h; IRQ = 4</li> <li>• IO = 3F8h; IRQ = 3, 4, 5, 6, 7, 9, 10, 11, 12</li> <li>• IO = 2F8h; IRQ = 3, 4, 5, 6, 7, 9, 10, 11, 12</li> <li>• IO = 3E8h; IRQ = 3, 4, 5, 6, 7, 9, 10, 11, 12</li> <li>• IO = 2E8h; IRQ = 3, 4, 5, 6, 7, 9, 10, 11, 12</li> </ul>
Device Mode	Change the serial port mode. Options: RS232 RS485 TX Low Active RS485 with Termination TX Low Active RS422 RES422 with Termination

## Serial Port 2 Configuration

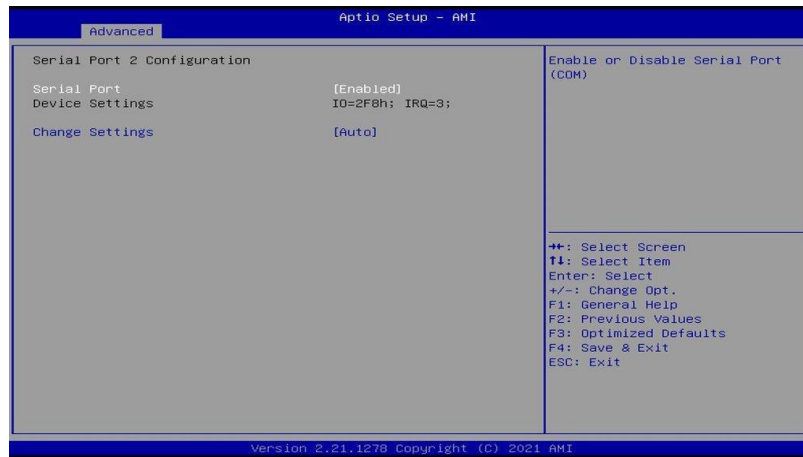

BIOS Setting	Description
Serial Port	Enables / Disables the serial port.
Change Settings	Selects an optimal settings for Super I/O device. Options: <ul style="list-style-type: none"> <li>• Auto</li> <li>• IO = 2F8h; IRQ = 3</li> <li>• IO = 3F8h; IRQ = 3, 4, 5, 6, 7, 9, 10, 11, 12</li> <li>• IO = 2F8h; IRQ = 3, 4, 5, 6, 7, 9, 10, 11, 12</li> <li>• IO = 3E8h; IRQ = 3, 4, 5, 6, 7, 9, 10, 11, 12</li> <li>• IO = 2E8h; IRQ = 3, 4, 5, 6, 7, 9, 10, 11, 12</li> </ul>

**Serial Port 3 Configuration**



BIOS Setting	Description
Serial Port	Enables / Disables the serial port.
Change Settings	Selects an optimal settings for Super I/O device. Options: <ul style="list-style-type: none"> <li>• Auto</li> <li>• IO = 3E8h; IRQ = 7</li> <li>• IO = 3E8h; IRQ = 3, 4, 5, 6, 7, 9, 10, 11, 12</li> <li>• IO = 2E8h; IRQ = 3, 4, 5, 6, 7, 9, 10, 11, 12</li> <li>• IO = 2F0h; IRQ = 3, 4, 5, 6, 7, 9, 10, 11, 12</li> <li>• IO = 2E0h; IRQ = 3, 4, 5, 6, 7, 9, 10, 11, 12</li> </ul>

## Serial Port 4 Configuration

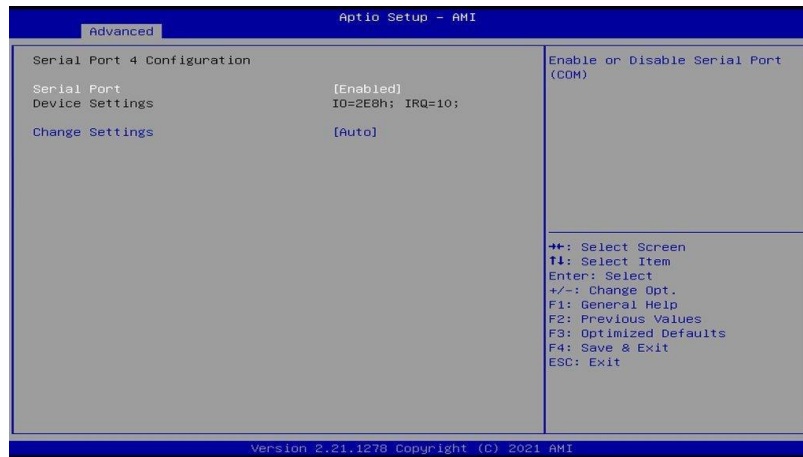

BIOS Setting	Description
Serial Port	Enables / Disables the serial port.
Change Settings	Selects an optimal settings for Super I/O device. Options: <ul style="list-style-type: none"> <li>• Auto</li> <li>• IO = 2E8h; IRQ = 7</li> <li>• IO = 3E8h; IRQ = 3, 4, 5, 6, 7, 9, 10, 11, 12</li> <li>• IO = 2E8h; IRQ = 3, 4, 5, 6, 7, 9, 10, 11, 12</li> <li>• IO = 2F0h; IRQ = 3, 4, 5, 6, 7, 9, 10, 11, 12</li> <li>• IO = 2E0h; IRQ = 3, 4, 5, 6, 7, 9, 10, 11, 12</li> </ul>

### 4.4.8 Fintek Hardware Monitor

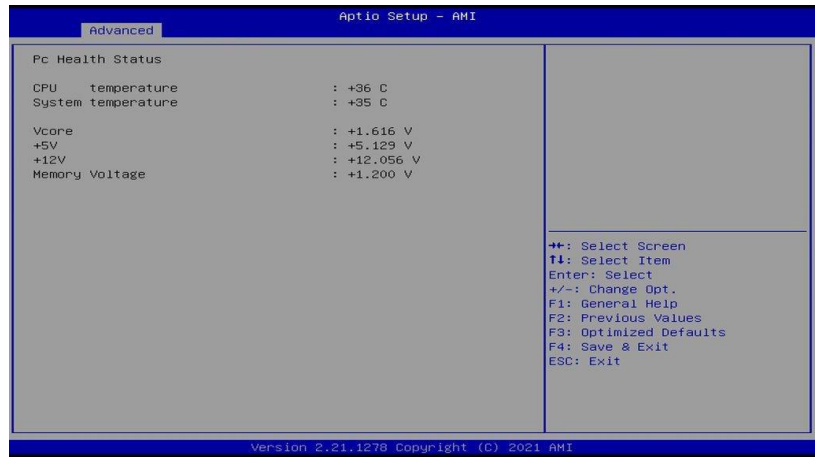

BIOS Setting	Description
Temperatures / Voltages	These fields are the parameters of the hardware monitoring function feature of the motherboard. The values are read-only values as monitored by the system and show the PC health status.



## 4.4.9 USB Configuration

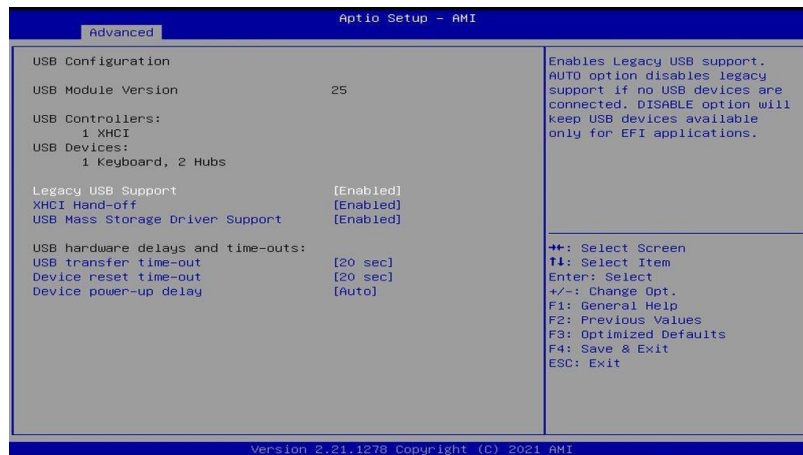

BIOS Setting	Description
Legacy USB Support	<ul style="list-style-type: none"> <li>• <b>Enabled</b> enables Legacy USB support.</li> <li>• <b>Auto</b> disables legacy support if there is no USB device connected.</li> <li>• <b>Disabled</b> keeps USB devices available only for EFI applications.</li> </ul>
XHCI Hand-off	This is a workaround for OSeS without XHCI hand-off support. The XHCI ownership change should be claimed by XHCI driver.
USB Mass Storage Driver Support	Enables / Disables the support for USB mass storage driver.
USB Transfer time-out	The time-out value (1 / 5 10 / 20 secs) for Control, Bulk, and Interrupt transfers.
Device reset time-out	Gives seconds (10 / 20 / 30 / 40 secs) to delay execution of Start Unit command to USB mass storage device.
Device power-up delay	<p>The maximum time the device will take before it properly reports itself to the Host Controller.</p> <p><b>Auto</b> uses default value for a Root port it is 100ms. But for a Hub port, the delay is taken from Hub descriptor.</p>

#### 4.4.10 Network Stack Configuration

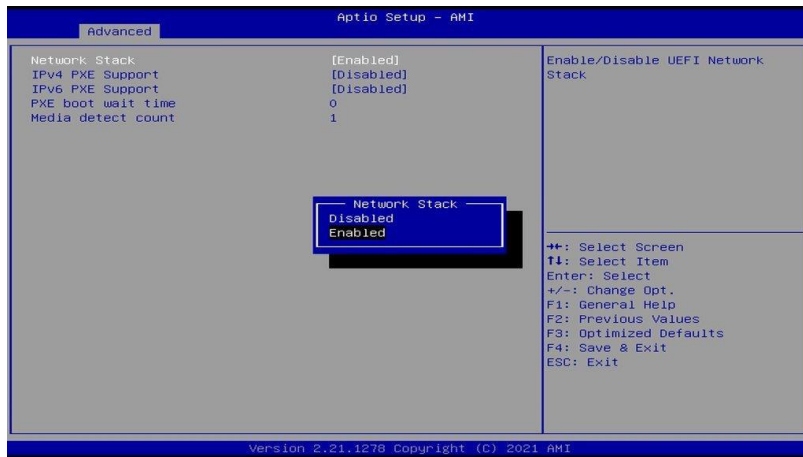

BIOS Setting	Description
Network Stack	Enable/Disable UEFI Network Stack
IPv4 PXE Support	Enable/Disable IPv4 PXE boot support. If disabled, IPv4 PXE boot support will not be available.
IPv6 PXE Support	Enable/Disable IPv6 PXE boot support. If disabled, IPv6 PXE boot support will not be available.
PXE boot wait time	Wait time in seconds to press ESC key to abort the PXE boot. Use either +/- or numeric keys to set the value.
Media detect count	Number of times the presence of media will be checked. Use either +/- or numeric keys to set the value.

## 4.5 Chipset Settings

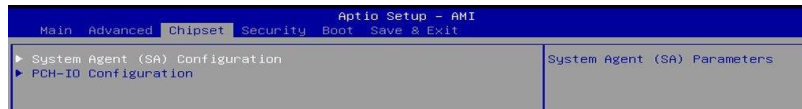

### 4.5.1 System Agent (SA) Configuration



BIOS Setting	Description
Primary display	Select which of IGFX/PEG/PCI Graphics device should be Primary Display or select HG for Hybrid Gfx
Internal Graphics	Keep IGFX enabled based on the setup options
GTT Size	Options: 2MB, 4MB, 8MB
Aperture Size	Select the Aperture Size. Note: Above 4GB MMIO BIOS assignment is automatically enabled when selecting 2048MB aperture. To use this feature, please disable CSM Support
VT-d	Enable/Disable VT-d capability

## 4.5.2 PCH-IO Configuration

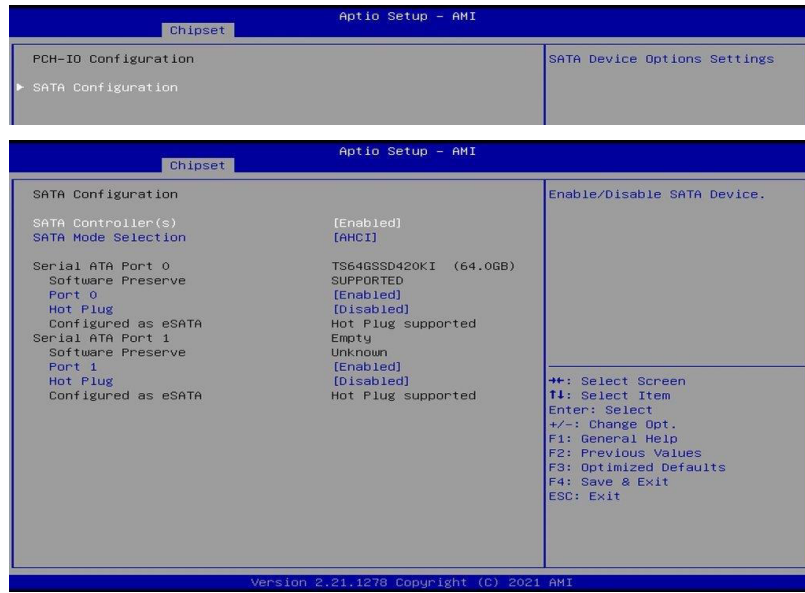

BIOS Setting	Description
SATA Controller(s)	Enables / Disables the Serial ATA.
SATA Mode Selection	Selects IDE or AHCI Mode.
Serial ATA Port 0~1	Enables / Disables Serial Port 0~1.
SATA Ports Hot Plug	Enables / Disables SATA Ports HotPlug.

## 4.6 Security Settings

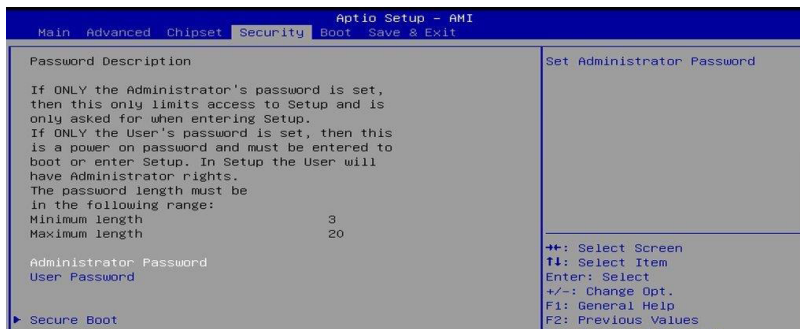

BIOS Setting	Description
Setup Administrator Password	Sets an administrator password for the setup utility.
User Password	Sets a user password.
Secure Boot	Secure Boot configuration

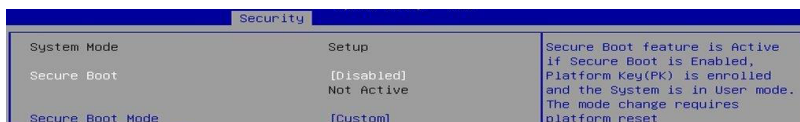



## 4.7 Boot Settings

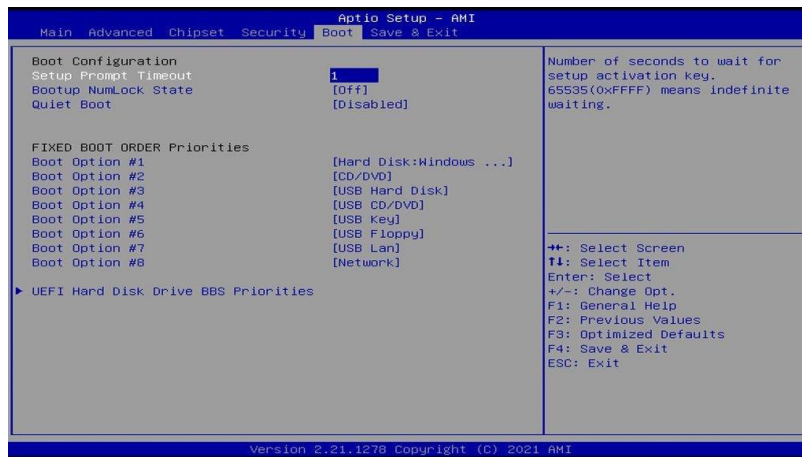

BIOS Setting	Description
Setup Prompt Timeout	Number of seconds to wait for setup activation key. 65535 (0xFFFF) means indefinite waiting.
Bootup NumLock State	Selects the keyboard NumLock state.
Quiet Boot	Enables / Disables Quiet Boot option.
Fast Boot	Enables / Disables boot with initialization of a minimal set of devices required to launch the active boot option. Has no effect for BBS boot options.
Boot mode select	Selects a Boot mode, Legacy / UEFI / Dual.
Boot Option Priorities	Sets the system boot order priorities for hard disk, CD/DVD, USB, Network.
UEFI Hard Disk Drives BBS Priorities	Specifies the Boot Device Priority sequence from available UEFI Hark Disk Drives.

## 4.8 Save & Exit Settings

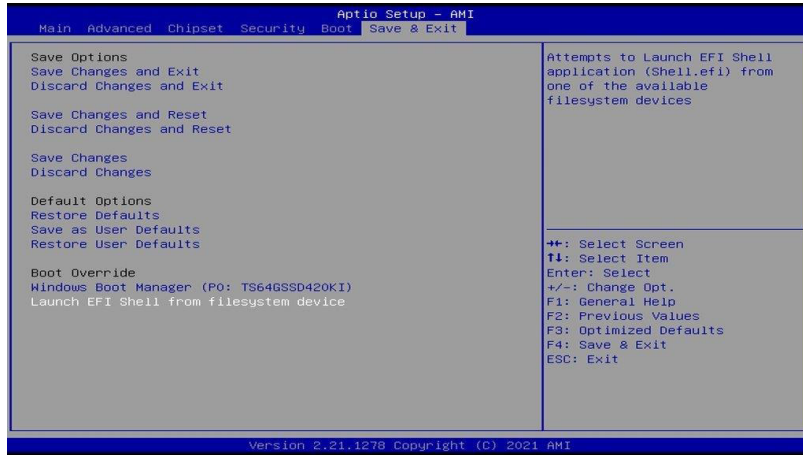

BIOS Setting	Description
Save Changes and Exit	Exits system setup after saving the changes.
Discard Changes and Exit	Exits system setup without saving any changes.
Save Changes and Reset	Resets the system after saving the changes.
Discard Changes and Reset	Resets system setup without saving any changes.
Save Changes	Saves changes done so far to any of the setup options.
Discard Changes	Discards changes done to any of the setup options.
Restore Defaults	Restores / Loads defaults values for all the setup options.
Save as User Defaults	Saves the changes done so far as User Defaults.
Restore User Defaults	Restores the user defaults to all the setup options.
Launch EFI Shell from filesystem device	Attempts to launch EFI shell application (shell.efi) from one of the available filesystem devices.



## Appendix

This section provides the mapping addresses of peripheral devices and the sample code of watchdog timer configuration.

## A. I/O Port Address Map

Each peripheral device in the system is assigned a set of I/O port addresses which also becomes the identity of the device. The following table lists the I/O port addresses used.

Address	Device Description
0x0000F090-0x0000F097	Standard SATA AHCI Controller
0x0000F080-0x0000F083	Standard SATA AHCI Controller
0x0000F060-0x0000F07F	Standard SATA AHCI Controller
0x00000A00-0x00000A1F	Motherboard resources
0x00000A20-0x00000A2F	Motherboard resources
0x00000A30-0x00000A3F	Motherboard resources
0x00000A40-0x00000A4F	Motherboard resources
0x00000A50-0x00000A5F	Motherboard resources
0x00000A60-0x00000A6F	Motherboard resources
0x0000002E-0x0000002F	Motherboard resources
0x0000004E-0x0000004F	Motherboard resources
0x00000061-0x00000061	Motherboard resources
0x00000063-0x00000063	Motherboard resources
0x00000065-0x00000065	Motherboard resources
0x00000067-0x00000067	Motherboard resources
0x00000070-0x00000070	Motherboard resources
0x00000070-0x00000070	System CMOS/real time clock
0x00000080-0x00000080	Motherboard resources
0x00000092-0x00000092	Motherboard resources
0x000000B2-0x000000B3	Motherboard resources
0x00000680-0x0000069F	Motherboard resources
0x0000FFFF-0x0000FFFF	Motherboard resources
0x0000FFFF-0x0000FFFF	Motherboard resources
0x0000FFFF-0x0000FFFF	Motherboard resources
0x00001800-0x000018FE	Motherboard resources
0x0000164E-0x0000164F	Motherboard resources
0x00000062-0x00000062	Microsoft ACPI-Compliant Embedded Controller

Address	Device Description
0x00000066-0x00000066	Microsoft ACPI-Compliant Embedded Controller
0x0000E000-0x0000EFFF	Mobile 6th/7th Generation Intel(R) Processor Family I/O PCI Express Root Port #1 - 9D10
0x0000F000-0x0000F03F	Intel(R) Iris(R) Plus Graphics 650
0x00000020-0x00000021	Programmable interrupt controller
0x00000024-0x00000025	Programmable interrupt controller
0x00000028-0x00000029	Programmable interrupt controller
0x0000002C-0x0000002D	Programmable interrupt controller
0x00000030-0x00000031	Programmable interrupt controller
0x00000034-0x00000035	Programmable interrupt controller
0x00000038-0x00000039	Programmable interrupt controller
0x0000003C-0x0000003D	Programmable interrupt controller
0x000000A0-0x000000A1	Programmable interrupt controller
0x000000A4-0x000000A5	Programmable interrupt controller
0x000000A8-0x000000A9	Programmable interrupt controller
0x000000AC-0x000000AD	Programmable interrupt controller
0x000000B0-0x000000B1	Programmable interrupt controller
0x000000B4-0x000000B5	Programmable interrupt controller
0x000000B8-0x000000B9	Programmable interrupt controller
0x000000BC-0x000000BD	Programmable interrupt controller
0x000004D0-0x000004D1	Programmable interrupt controller
0x00000000-0x00000CF7	PCI Express Root Complex
0x00000D00-0x0000FFFF	PCI Express Root Complex
0x00000040-0x00000043	System timer
0x00000050-0x00000053	System timer
0x00001854-0x00001857	Motherboard resources
0x0000FF00-0x0000FFFE	Motherboard resources
0x0000F040-0x0000F05F	Mobile 6th/7th Generation Intel(R) Processor Family I/O SMBUS - 9D23

**B. Interrupt Request Lines (IRQ)**

Peripheral devices use interrupt request lines to notify CPU for the service required. The following table shows the IRQ used by the devices on board.

<b>Level</b>	<b>Function</b>
IRQ 0	System timer
IRQ 8	System CMOS/real time clock
IRQ 14	Motherboard resources
IRQ 55~204	Microsoft ACPI-Compliant System
IRQ 256~511	Microsoft ACPI-Compliant System
IRQ 4294967294	Standard SATA AHCI Controller
IRQ 4294967290	Intel(R) Ethernet Connection (4) I219-V
IRQ 4294967289	Intel(R) Management Engine Interface
IRQ 4294967288	Intel(R) Dual Band Wireless-AC 8265
IRQ 4294967291	Intel(R) Iris(R) Plus Graphics 650
IRQ 4294967287	Intel(R) Smart Sound Technology (Intel(R) SST) Audio Controller
IRQ 4294967292	Intel(R) USB 3.0 eXtensible Host Controller - 1.0 (Microsoft)
IRQ 4294967293	Realtek PCIE CardReader

## C. Watchdog Timer Configuration

The Watchdog Timer (WDT) is used to generate a variety of output signals after a user programmable count. The WDT is suitable for use in the prevention of system lock-up, such as when software becomes trapped in a deadlock. Under these sorts of circumstances, the timer will count to zero and the selected outputs will be driven.

Under normal circumstance, you will need to restart the WDT at regular intervals before the timer counts to zero.

### Sample Code:

```
//-----
//
// THIS CODE AND INFORMATION IS PROVIDED "AS IS" WITHOUT WARRANTY OF ANY
// KIND, EITHER EXPRESSED OR IMPLIED, INCLUDING BUT NOT LIMITED TO THE
// IMPLIED WARRANTIES OF MERCHANTABILITY AND/OR FITNESS FOR A PARTICULAR
// PURPOSE.
//
//-----
#include <dos.h>
#include <conio.h>
#include <stdio.h>
#include <stdlib.h>
#include "F81866.H"
//-----
int main (int argc, char *argv[]);
void EnableWDT(int);
void DisableWDT(void);
//-----
int main (int argc, char *argv[])
{
    unsigned char bBuf;
    unsigned char bTime;
    char **endptr;

    char SIO;

    printf("Fintek 81866 watch dog program\n");
    SIO = Init_F81866();
    if (SIO == 0)
    {
        printf("Can not detect Fintek 81866, program abort.\n");
        return(1);
    }/if (SIO == 0)

    if (argc != 2)
    {
        printf(" Parameter incorrect!!\n");
        return (1);
    }
}
```

```

    bTime = strtol (argv[1], endptr, 10);
    printf("System will reset after %d seconds\n", bTime);

    if (bTime)
    {
        EnableWDT(bTime);
    }
    else
    {
        DisableWDT();
    }
    return 0;
}
//-----
void EnableWDT(int interval)
{
    unsigned char bBuf;

    bBuf = Get_F81866_Reg(0x2B);
    bBuf &= (~0x20);
    Set_F81866_Reg(0x2B, bBuf);           //Enable WDTO

    Set_F81866_LD(0x07);                 //switch to logic device 7
    Set_F81866_Reg(0x30, 0x01);         //enable timer

    bBuf = Get_F81866_Reg(0xF5);
    bBuf &= (~0x0F);
    bBuf |= 0x52;
    Set_F81866_Reg(0xF5, bBuf);         //count mode is second

    Set_F81866_Reg(0xF6, interval);     //set timer

    bBuf = Get_F81866_Reg(0xFA);
    bBuf |= 0x01;
    Set_F81866_Reg(0xFA, bBuf);         //enable WDTO output

    bBuf = Get_F81866_Reg(0xF5);
    bBuf |= 0x20;
    Set_F81866_Reg(0xF5, bBuf);         //start counting
}
//-----
void DisableWDT(void)
{
    unsigned char bBuf;

    Set_F81866_LD(0x07);                 //switch to logic device 7

    bBuf = Get_F81866_Reg(0xFA);
    bBuf &= ~0x01;
    Set_F81866_Reg(0xFA, bBuf);         //disable WDTO output

    bBuf = Get_F81866_Reg(0xF5);
    bBuf &= ~0x20;
    bBuf |= 0x40;
    Set_F81866_Reg(0xF5, bBuf);         //disable WDT
}
//-----
//-----

```

```

//
// THIS CODE AND INFORMATION IS PROVIDED "AS IS" WITHOUT WARRANTY OF ANY
// KIND, EITHER EXPRESSED OR IMPLIED, INCLUDING BUT NOT LIMITED TO THE
// IMPLIED WARRANTIES OF MERCHANTABILITY AND/OR FITNESS FOR A PARTICULAR
// PURPOSE.
//
//-----
#include "F81866.H"
#include <dos.h>
//-----
unsigned int F81866_BASE;
void Unlock_F81866 (void);
void Lock_F81866 (void);
//-----
unsigned int Init_F81866(void)
{
    unsigned int result;
    unsigned char ucDid;

    F81866_BASE = 0x4E;
    result = F81866_BASE;

    ucDid = Get_F81866_Reg(0x20);
    if (ucDid == 0x07) //Fintek81866
    {
        goto Init_Finish;
    }

    F81866_BASE = 0x2E;
    result = F81866_BASE;

    ucDid = Get_F81866_Reg(0x20);
    if (ucDid == 0x07) //Fintek81866
    {
        goto Init_Finish;
    }

    F81866_BASE = 0x00;
    result = F81866_BASE;

Init_Finish:
    return (result);
}
//-----
void Unlock_F81866 (void)
{
    outportb(F81866_INDEX_PORT, F81866_UNLOCK);
    outportb(F81866_INDEX_PORT, F81866_UNLOCK);
}
//-----
void Lock_F81866 (void)
{
    outportb(F81866_INDEX_PORT, F81866_LOCK);
}
//-----
void Set_F81866_LD( unsigned char LD)
{
    Unlock_F81866();
    outportb(F81866_INDEX_PORT, F81866_REG_LD);
    outportb(F81866_DATA_PORT, LD);
    Lock_F81866();
}

```

```
}
//-----
void Set_F81866_Reg(unsigned char REG, unsigned char DATA)
{
    Unlock_F81866();
    outportb(F81866_INDEX_PORT, REG);
    outportb(F81866_DATA_PORT, DATA);
    Lock_F81866();
}
//-----
unsigned char Get_F81866_Reg(unsigned char REG)
{
    unsigned char Result;
    Unlock_F81866();
    outportb(F81866_INDEX_PORT, REG);
    Result = inportb(F81866_DATA_PORT);
    Lock_F81866();
    return Result;
}
//-----

//-----
//
// THIS CODE AND INFORMATION IS PROVIDED "AS IS" WITHOUT WARRANTY OF ANY
// KIND, EITHER EXPRESSED OR IMPLIED, INCLUDING BUT NOT LIMITED TO THE
// IMPLIED WARRANTIES OF MERCHANTABILITY AND/OR FITNESS FOR A PARTICULAR
// PURPOSE.
//
//-----
#ifndef F81866_H
#define F81866_H                1
//-----
#define F81866_INDEX_PORT      (F81866_BASE)
#define F81866_DATA_PORT      (F81866_BASE+1)
//-----
#define F81866_REG_LD          0x07
//-----
#define F81866_UNLOCK          0x87
#define F81866_LOCK            0xAA
//-----
unsigned int Init_F81866(void);
void Set_F81866_LD(unsigned char);
void Set_F81866_Reg(unsigned char, unsigned char);
unsigned char Get_F81866_Reg(unsigned char);
//-----
#endif // F81866_H
```



## D. Onboard Connector Reference Types

Function	Connector	Onboard Type	Compatible Mating Type
Audio Connector		Hao Guo Xing Ye DF11-12S-PA66H	Hirose DF11-12DS-2C
SATA HDD Power Connector		E-call 0110-071-040	JST XHP-4
Front Panel Setting Connector		Dupon 2.54 mm-pitch pin header (Male)	Dupon 2.54 mm-pitch (Female)
USB 2.0 Connector		Hao Guo Xing Ye DF11-8S-PA66H	Hirose DF11-8DS-2C
Battery Connector		Molex 53047-0210	Molex 51021-0200
COM 2, COM3, COM4 RS-232 Ports		Hao Guo Xing Ye DF11-10S-PA66H	Hirose DF11-10DS-2C
DC Power Input Connector		Hao Guo Xing Ye WAFER396-2S-WV	JST VHR-2N
Digital I/O Connector		Dupon 2.00 mm-pitch pin header (Male)	Dupon 2.00 mm-pitch (Female)
LCD Backlight Connector		E-CALL 0110-161-040	JST PHR-4.
LVDS Connectors		Hirose DF20G-20DP-1V	Hirose DF20A-20DS-1C

Our company network supports you worldwide with offices in Germany, Austria, Switzerland, the UK and the USA. For more information please contact:

## Headquarters

### Germany



#### FORTEC Elektronik AG

Augsburger Str. 2b  
82110 Germering

Phone: +49 89 894450-0  
E-Mail: [info@forteca.de](mailto:info@forteca.de)  
Internet: [www.forteca.de](http://www.forteca.de)

## Fortec Group Members

### Austria



#### Distec GmbH Office Vienna

Nuschinggasse 12  
1230 Wien

Phone: +43 1 8673492-0  
E-Mail: [info@distec.de](mailto:info@distec.de)  
Internet: [www.distec.de](http://www.distec.de)

### Germany



#### Distec GmbH

Augsburger Str. 2b  
82110 Germering

Phone: +49 89 894363-0  
E-Mail: [info@distec.de](mailto:info@distec.de)  
Internet: [www.distec.de](http://www.distec.de)

### Switzerland



#### ALTRAC AG

Bahnhofstraße 3  
5436 Würenlos

Phone: +41 44 7446111  
E-Mail: [info@altrac.ch](mailto:info@altrac.ch)  
Internet: [www.altrac.ch](http://www.altrac.ch)

### United Kingdom



#### Display Technology Ltd.

Osprey House, 1 Osprey Court  
Hichingbrooke Business Park  
Huntingdon, Cambridgeshire, PE29 6FN

Phone: +44 1480 411600  
E-Mail: [info@displaytechnology.co.uk](mailto:info@displaytechnology.co.uk)  
Internet: [www.displaytechnology.co.uk](http://www.displaytechnology.co.uk)

### USA



#### Apollo Display Technologies, Corp.

87 Raynor Avenue,  
Unit 1 Ronkonkoma,  
NY 11779

Phone: +1 631 5804360  
E-Mail: [info@apolloDisplays.com](mailto:info@apolloDisplays.com)  
Internet: [www.apolloDisplays.com](http://www.apolloDisplays.com)