



OUR GLOBAL
COMPETENCE
CENTRES

 APOLLO DISPLAY
TECHNOLOGIES



 DISTEC



 DISPLAY
TECHNOLOGY



Manual

iBASE

IB952

3,5" Industrial Single-Board Computer with AMD®Ryzen™ V2000 Series Processor

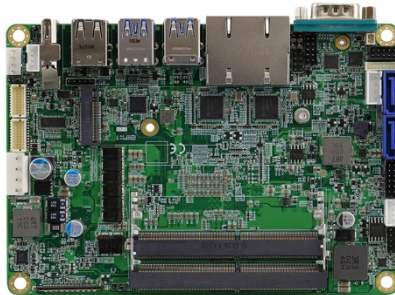

The information contained in this document has been carefully researched and is, to the best of our knowledge, accurate. However, we assume no liability for any product failures or damages, immediate or consequential, resulting from the use of the information provided herein. Our products are not intended for use in systems in which failures of product could result in personal injury. All trademarks mentioned herein are property of their respective owners. All specifications are subject to change without notice.

IB952 Series

**AMD V2000™
3.5" Disk-Size SBC**

User's Manual

Version 1.0
(August 2021)

Copyright

© 2021 IBASE Technology, Inc. All rights reserved.

No part of this publication may be reproduced, copied, stored in a retrieval system, translated into any language or transmitted in any form or by any means, electronic, mechanical, photocopying, or otherwise, without the prior written consent of IBASE Technology, Inc. (hereinafter referred to as “IBASE”).

Disclaimer

IBASE reserves the right to make changes and improvements to the products described in this document without prior notice. Every effort has been made to ensure the information in the document is correct; however, IBASE does not guarantee this document is error-free.

IBASE assumes no liability for incidental or consequential damages arising from misapplication or inability to use the product or the information contained herein, nor for any infringements of rights of third parties, which may result from its use.

Trademarks

All the trademarks, registrations and brands mentioned herein are used for identification purposes only and may be trademarks and/or registered trademarks of their respective owners.

Compliance



This is a class B product. In a domestic environment, this product may cause radio interference in which case users may be required to take adequate measures.



This product has been tested and found to comply with the limits for a Class B device, pursuant to Part 15 of the FCC Rules. These limits are designed to provide reasonable protection against harmful interference in a residential installation. This equipment generates, uses and can radiate radio frequency energy and, if not installed and used in accordance with manufacturer's instructions, may cause harmful interference to radio communications.

WEEE



This product must not be disposed of as normal household waste, in accordance with the EU directive of for waste electrical and electronic equipment (WEEE - 2012/19/EU). Instead, it should be disposed of by returning it to a municipal recycling collection point. Check local regulations for disposal of electronic products.

Green IBASE



This product is compliant with the current RoHS restrictions and prohibits use of the following substances in concentrations exceeding 0.1% by weight (1000 ppm) except for cadmium, limited to 0.01% by weight (100 ppm).

- Lead (Pb)
- Mercury (Hg)
- Cadmium (Cd)
- Hexavalent chromium (Cr6+)
- Polybrominated biphenyls (PBB)
- Polybrominated diphenyl ether (PBDE)

Important Safety Information

Carefully read the precautions before using the board.

Environmental conditions:

- Use this product in environments with ambient temperatures between 0°C and 60°C.
- Do not leave this product in an environment where the storage temperature may be below -20° C or above 70° C. To prevent from damages, the product must be used in a controlled environment.

Care for your iBASE products:

- Before cleaning the PCB, unplug all cables and remove the battery.
- Clean the PCB with a circuit board cleaner, degreaser, or use cotton swabs and alcohol.
- Vacuum the dust with a computer vacuum cleaner to prevent the fan from being clogged.



WARNING

Attention during use:

- Do not use this product near water.
- Do not spill water or any other liquids on this product.
- Do not place heavy objects on the top of this product.

Anti-static precautions

- Wear an anti-static wrist strap to avoid electrostatic discharge.
- Place the PCB on an anti-static kit or mat.
- Hold the edges of PCB when handling.
- Touch the edges of non-metallic components of the product instead of the surface of the PCB.
- Ground yourself by touching a grounded conductor or a grounded bit of metal frequently to discharge any static.



CAUTION

Replace only with the same or equivalent type recommended by the manufacturer. Dispose of used batteries according to the manufacturer's instructions or recycle them at a local recycling facility or battery collection point.

Warranty Policy

- **IBASE standard products:**

24-month (2-year) warranty from the date of shipment. If the date of shipment cannot be ascertained, the product serial numbers can be used to determine the approximate shipping date.

- **3rd-party parts:**

12-month (1-year) warranty from delivery for the 3rd-party parts that are not manufactured by IBASE, such as CPU, CPU cooler, memory, storage devices, power adapter, panel and touchscreen.

- * PRODUCTS, HOWEVER, THAT FAIL DUE TO MISUSE, ACCIDENT, IMPROPER INSTALLATION OR UNAUTHORIZED REPAIR SHALL BE TREATED AS OUT OF WARRANTY AND CUSTOMERS SHALL BE BILLED FOR REPAIR AND SHIPPING CHARGES.

Technical Support & Services

1. Visit the IBASE website at www.ibase.com.tw to find the latest information about the product.
2. If you need any further assistance from your distributor or sales representative concerning problems that you may have encountered, please prepare the following information:
 - Product model name
 - Product serial number
 - Detailed description of the problem
 - The error messages in text or in screenshots if there is any
 - The arrangement of the peripherals
 - Software in use (such as OS and application software, including the version numbers)
3. If repair service is required, you can download the RMA form at <http://www.ibase.com.tw/english/Supports/RMAService/>. Fill out the form and contact your distributor or sales representative.

Table of Contents

Chapter 1	General Information	1
1.1	Introduction	2
1.2	Features	2
1.3	Packing List	3
1.4	Optional Accessories	3
1.5	Specifications	4
1.6	Block Diagram	6
1.7	Product View	錯誤! 尚未定義書籤。
1.8	Dimensions	9
Chapter 2	Hardware Configuration	11
2.1	Installations	12
2.2	Setting the Jumpers	12
2.3	Jumper & Connector Locations on IB952	14
2.4	Jumpers Quick Reference	15
2.5	Connectors Quick Reference	19
Chapter 3	Drivers Installation	31
3.1	Introduction	32
3.2	AMD Ryzen V2000 Chipset Drivers Installation	32
3.3	AMD Ryzen V2000 Graphics Drivers Installation	34
3.4	Realtek High Definition Audio Driver Installation	36
3.5	LAN Driver Installation	37
Chapter 4	BIOS Setup	39
4.1	Introduction	40
4.2	BIOS Setup	40
4.3	Main Settings	41
4.4	Advanced Settings	41
4.5	Chipset Settings	55
4.6	Security Settings	56
4.7	Boot Settings	58
4.8	Save & Exit Settings	59
Appendix	61
A.	I/O Port Address Map	62
B.	Interrupt Request Lines (IRQ)	64
C.	Onboard Connector Types	65

Chapter 1

General Information

The information provided in this chapter includes:

- Features
- Packing List
- Specifications
- Block Diagram
- Product View
- Board Dimensions

1.1 Introduction

- IB952F is a 3.5-inch SBC based on AMD Ryzen™ V2000-series processor. The integrated graphics device on the AMD Ryzen V2000-series processor integrated graphics drives four DisplayPort interfaces. Aside from supporting two DDR4 with up to 64GB capacity, it features flexible I/O connections are provided by 2 x GbE, 3 x USB 3.1, 2 x USB 2.0, 2 x COM, 2x SATA III, 2 x M.2 (M2280 & E2230), and 1 x USB Type C (USB3.1 Gen.2).

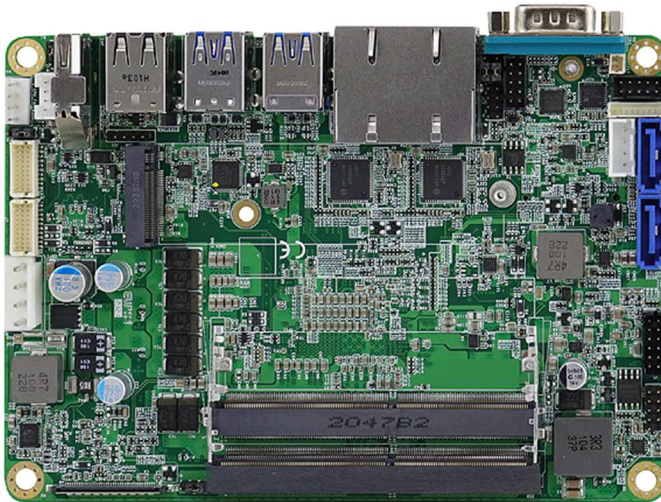

IB952F

1.2 Features

- AMD Ryzen™ V2000-series processor, up to 4.15 GHz
- 2 x DDR4 SO-DIMM, expandable up to 64GB, ECC supported per CPU SKUs
- AMD Ryzen™ V2000-series processor integrated graphics device for four DisplayPort
- 2 x GbE, 3 x USB 3.1, 2 x USB 2.0, 2 x COM, 2x SATA III
- 2 x M.2 (M2280 & E2230)
- 1 x USB Type C (USB3.1 Gen.2)
- Configurable watchdog timer and digital I/O
- TPM (2.0)

1.3 Packing List

Your IB952F package should include the items listed below. If any of the items below is missing, contact the distributor or dealer from whom you purchased the product.

- IB952F Motherboard
- Disk (for chipset drivers)
- This User's Manual

1.4 Optional Accessories

IBASE provides optional accessories as follows. Please contact us or your dealer if you need any.

- Cable kit (IB92) including:
 - SATA & HDD power cable (SATA-53A) x1
 - COM port cable (PK1H) x1
 - DC-in power cable (PW595) x1
- Audio cable (Audio-18)
- Heat sink (HSIB952-B for IB952F-2748)
- Heat sink (HSIB952-A for IB952F-2718)
- Heat spreader (HSIB952-1)

1.5 Specifications

Model Name	IB952F-2748	IB952F-2718
Form Factor	3.5" Disk-Size SBC	
System		
Operating System	<ul style="list-style-type: none"> • Windows 10 • Linux Ubuntu 	
CPU Type	AMD Ryzen™ V2748	AMD Ryzen™ V2718
CPU Speed	2.9 GHz / 4.15 GHz	1.7 GHz / 4.15 GHz
Cache	8MB / L3; 4MB / L2	8MB / L3; 4MB / L2
Chipset	Integrated in AMD Ryzen™ V2000-series processor	
Memory	2 x DDR4-3200 SO-DIMM, Up to 64GB (ECC or Non-ECC)	
Storage	M.2 socket x 1(M-Key, type 2280) SSD	
Graphics	AMD Ryzen™ V2000-series integrated graphics	
Network	2 x Intel I211AT	
Super I/O	Fintek F81804U-I	
Audio Codec & Controller	AMD Ryzen™ V2000-series processor built-in HD audio controller Realtek ALC888S codec	
Power Requirement	12V ~ 24V DC-In	
USB Type C	USB 3.1 (Gen.2)	
TPM	2.0	
Watchdog Timer	Yes (256 segments, 0, 1, 2...255 sec / min)	
BIOS	AMI BIOS	
H/W Monitor	Yes	
Dimensions	102.22 x 147.01 mm (4.02" x 5.8")	
RoHS	Yes	
Certification	CE, FCC Class B	

I/O Ports	
Display	<ul style="list-style-type: none"> • 1 x DisplayPort (1.4, DP++) 3840 x 2160 at 60 Hz (depending on AMD support) • 1 x USB Type C (DisplayPort 1.2) 3840 x 2160 at 60Hz • 1 x dual-channel LVDS, 1920 x 1080 at 60 Hz • 1 x EDP (1.4) 4096 x 2304 at 60 Hz
LAN	2 x RJ45 GbE
USB	<ul style="list-style-type: none"> • 3 x USB3.1 (Gen2) @real panel • 2 x USB2.0 @real panel
Serial	<p>2 x COM ports:</p> <ul style="list-style-type: none"> • COM1: RS-232/422/485 (I/O coastline DB9 connector, jumper-less selection) • COM2: RS-232 only (via on-board box-headers)
SATA	2 x SATA III
Audio	Onboard audio connector for Line-In, Line-Out, and Mic-In
Digital IO	4-In & 4-Out
Expansion Slots	M.2 socket x 1 (M-Key, type 2280), M.2 socket x 1 (E-Key, type 2230),
Environment	
Temperature	<ul style="list-style-type: none"> • Operation: 0 ~ 60 °C (32 ~ 140 °F) • Storage: -20 ~ 80 °C (-4 ~ 176 °F)
Relative Humidity	0 ~ 90 %, non-condensing at 60 °C

All specifications are subject to change without prior notice.

1.6 Block Diagram

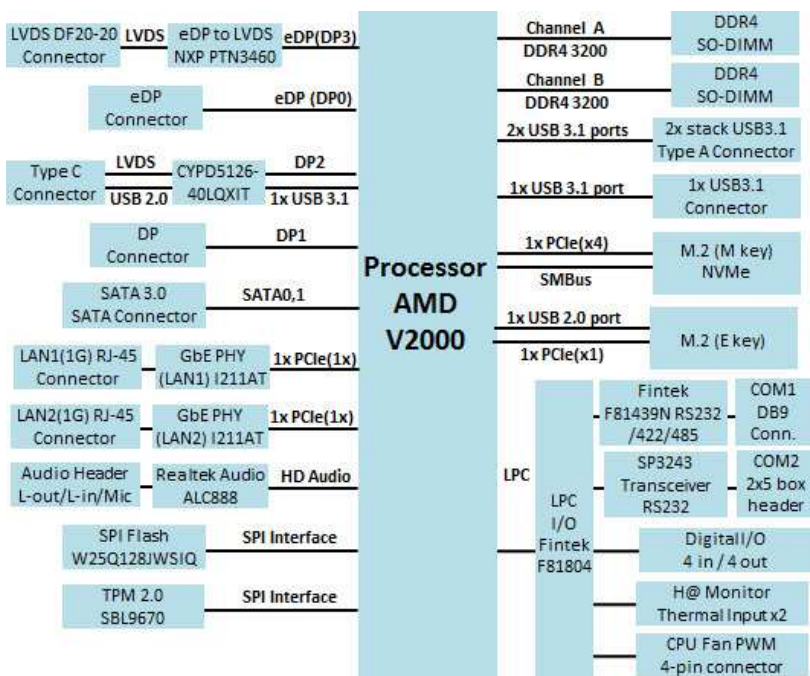

1.7 Product View

Top View

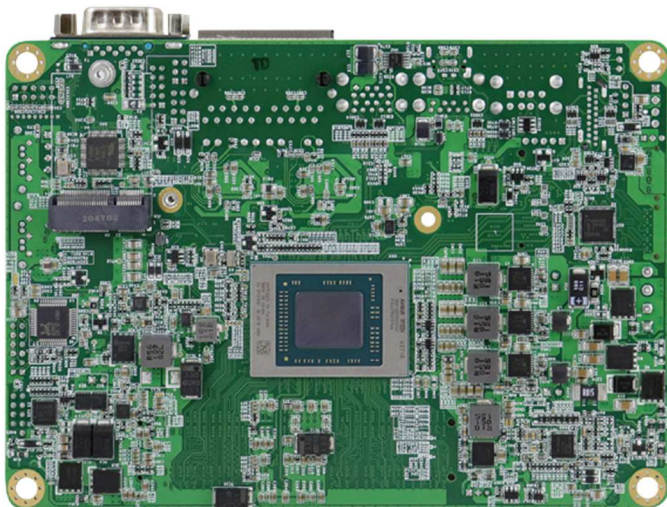
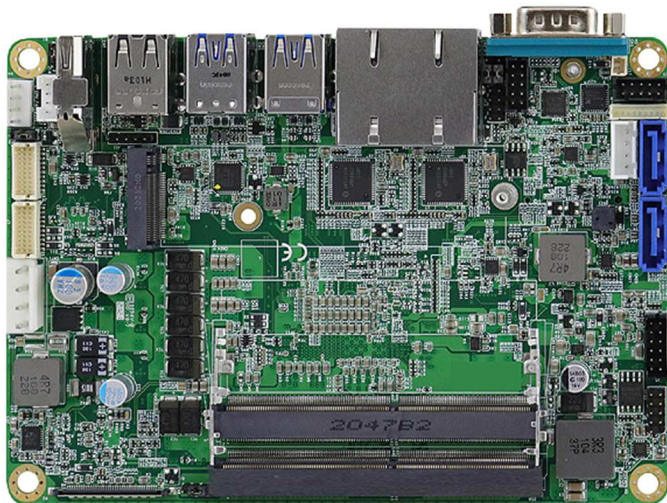

* The photos above are for reference only. Some minor components may differ.

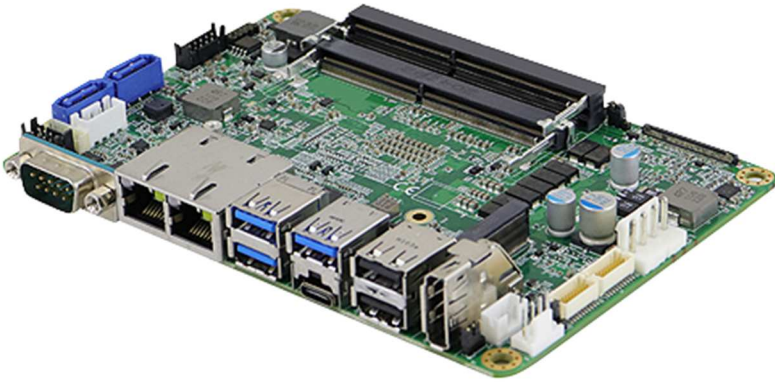
Oblique View**I/O View**

No.	Name	No.	Name
1	COM1 Port	5	1 USB 3.1 Port (top)
2	LAN2 Port	6	1 USB Type C (bottom)
3	LAN1 Port	7	2 USB 2.0 Ports
4	2 USB 3.1 Ports	8	DisplayPort

* Connectors are listed from left to right positions.

Dimensions

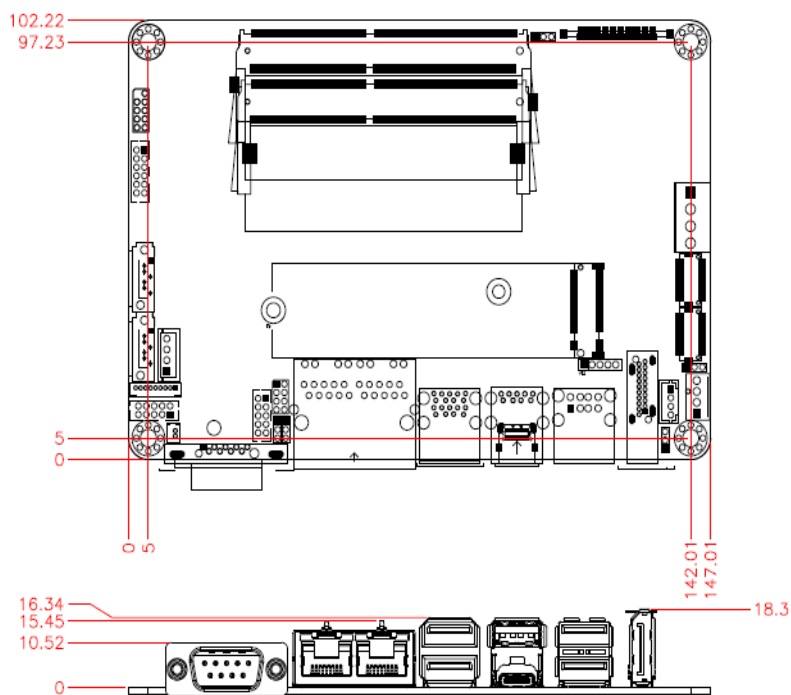

THIS PAGE IS INTENTIONALLY LEFT BLANK.

Chapter 2

Hardware Configuration

This section provides information on jumper settings and connectors on the IB952F in order to set up a workable system. On top of that, you will also need to install crucial pieces such as the CPU and the memory before using the product. The topics covered are:

- Installations
- Jumper and connector locations
- Jumper settings and information of connectors

2.1 Installations

2.1.1 Installing the Memory

To install the modules, locate the memory slot on the board and perform the following steps:

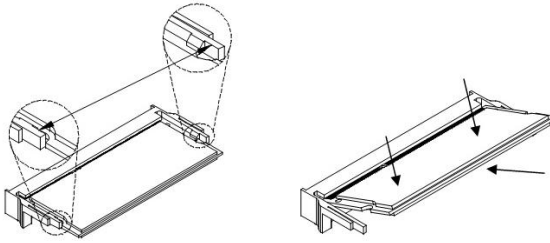

1. Align the key of the memory module with that on the memory slot and insert the module slantwise.
2. Gently push the module in an upright position until the clips of the slot close to hold the module in place when the module touches the bottom of the slot.

To remove the module, press the clips outwards with both hands, and the module will pop-up.

2.2 Setting the Jumpers

Set up and configure your IB952F by using jumpers for various settings and features according to your needs and applications. Contact your supplier if you have doubts about the best configuration for your use.

2.2.1 How to Set Jumpers

Jumpers are short-length conductors consisting of several metal pins with a non-conductive base mounted on the circuit board. Jumper caps are used to have the functions and features enabled or disabled. If a jumper has 3 pins, you can connect either PIN1 to PIN2 or PIN2 to PIN3 by shorting.

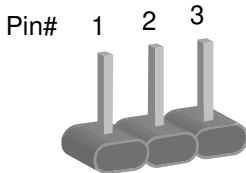

A 3-pin jumper

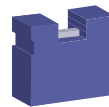

A jumper cap

Refer to the illustration below to set jumpers.

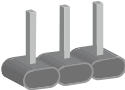
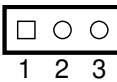
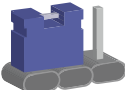
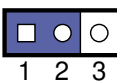
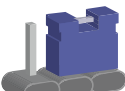
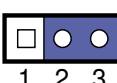
Pin closed	Oblique view	Illustration
Open		
1-2		
2-3		

When two pins of a jumper are encased in a jumper cap, this jumper is **closed**, i.e. turned **On**.

When a jumper cap is removed from two jumper pins, this jumper is **open**, i.e. turned **Off**.

2.3 Jumper & Connector Locations on IB952

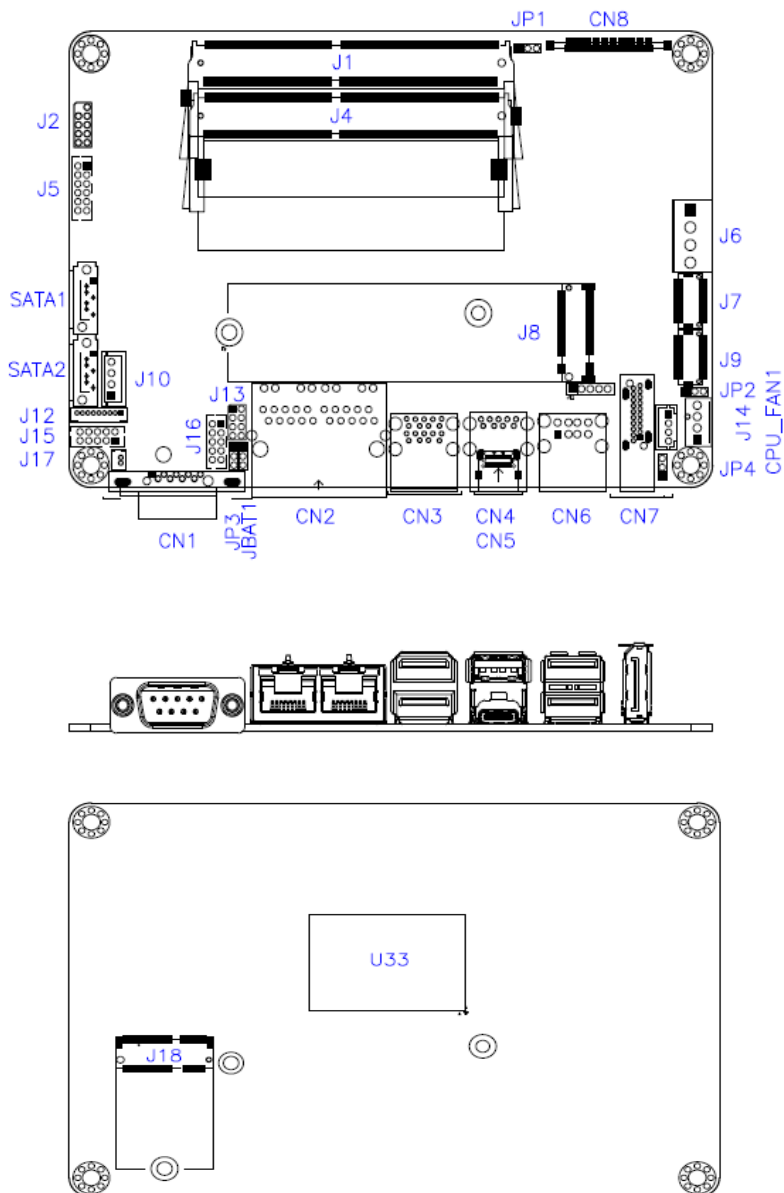

2.4 Jumpers Quick Reference

Function	Jumper	Page
CMOS Data Clearance	JBAT1	15
EDP Panel Power Selections	JP1	16
LVDS Panel Power / Brightness Selections	JP2 (For power) / JP4 (For brightness)	17
AT / ATX Mode Selections	JP3	18

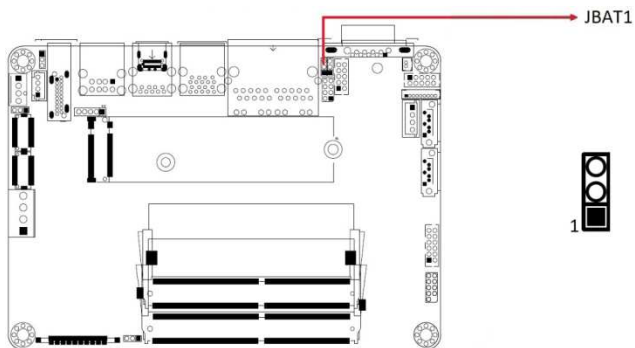

2.4.1 CMOS Data Clearance (JBAT1)

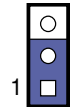
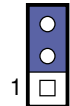

Function	Pin closed	Illustration
Normal (default)	1-2	
Clear CMOS	2-3	

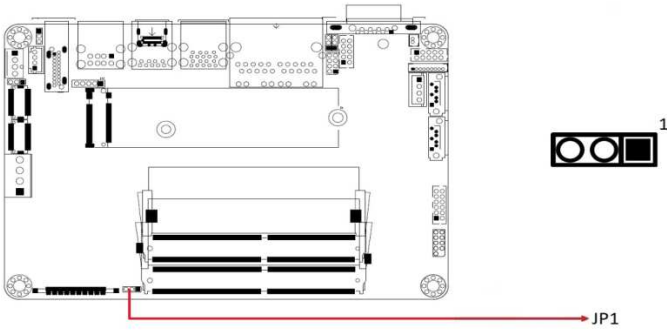
2.4.2 EDP Panel Power Selections (JP1)



Jumper	Function	Pin closed	Illustration
JP1	3.3V (default)	1-2	1 
	5V	2-3	1 

2.4.3 LVDS Panel Power / Brightness Selections (JP2 / JP4)

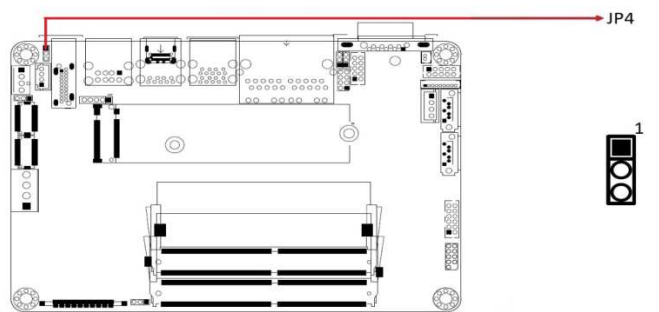
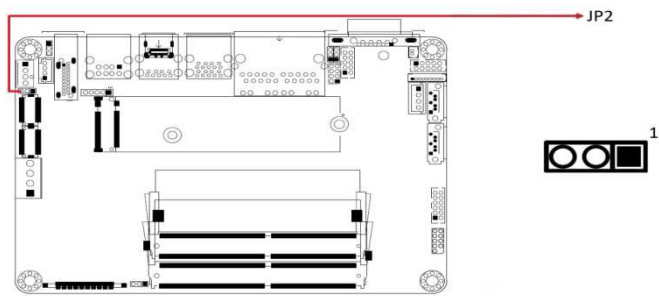

Jumper	Function	Pin closed	Illustration
JP2	3.3V (default)	1-2	1
	5V	2-3	1
JP4	3.3V (default)	1-2	1
	5V	2-3	1

2.4.5 AT/ATX Mode Selections (JP3)

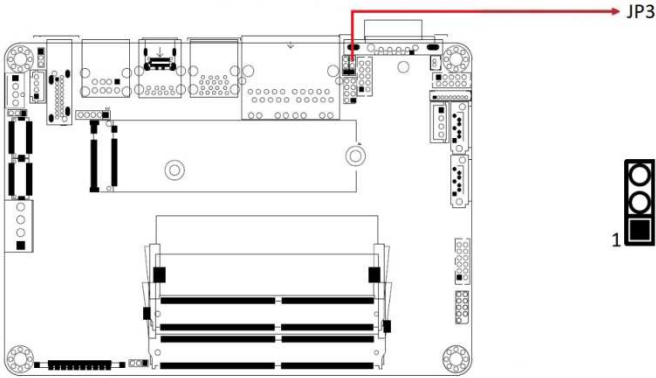

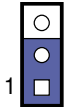
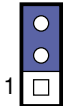
Function	Pin closed	Illustration
ATX Mode (default)	1-2	
AT Mode	2-3	

2.5 Connectors Quick Reference

Function	Connector	Page
COM1 Port	CN1	20
COM2 Port	J15	21
EDP Panel Connector	CN8	22
Digital I/O Connector	J16	23
LVDS Backlight Connector	J14	24
LVDS Panel Connector	J7, J9	25
Audio Connector	J5	26
Front Panel Settings Connector	J13	27
CPU Fan Power Connector	CPU_FAN1	28
SATA Power Connector	J10	29
DC-in Power Connector	J6	29
Display Port	CN7	--
USB 3.1 Connector	CN4	--
USB Type C Connector	CN5	--
Dual GbE Ports	CN2	--
Dual USB 3.1 Ports	CN3	--
Dual USB 2.0 Ports	CN6	--
SATA III Port	SATA1, SATA2	--
DDR4 SO-DIMM Slot	J1, J4	--
M.2 M2280 Slot	J8	--
M.2 E2230 Slot	J18	--
Factory Use Only	J2, J11, J12	--

2.5.1 COM1 RS-232/422/485 Ports (CN1)

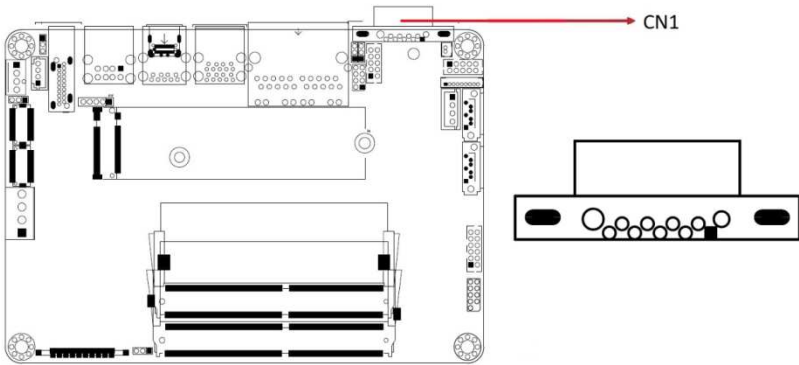

Pin	Signal Name	Pin	Signal Name
1	Data carrier detect	6	Data set ready
2	Receive data	7	Request to send
3	Transmit data	8	Clear to send
4	Data terminal ready	9	Ring indicator
5	Ground		

Pin	Signal Name		
	RS-232	RS-422	RS-485
1	DCD	TX-	DATA-
2	RX	TX+	DATA+
3	TX	RX+	NC
4	DTR	RX-	NC
5	Ground	Ground	Ground
6	DSR	NC	NC
7	RTS	NC	NC
8	CTS	NC	NC
9	RI	NC	NC

2.5.2 COM2 RS-232 Ports (J15)

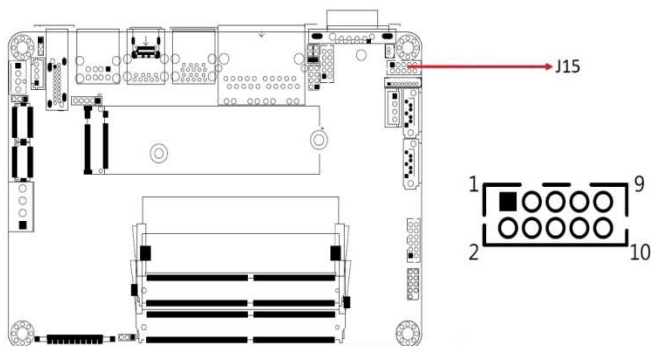

Remarks: HK_DF11-10S-PA66H

Pin	Signal Name	Pin	Signal Name
1	Data carrier detect	2	Receive data
3	Transmit data	4	Data terminal ready
5	Ground	6	Data set ready
7	Request to send	8	Clear to send
9	Ring indicator	10	Key

2.5.1 eDP Connector (CN8)

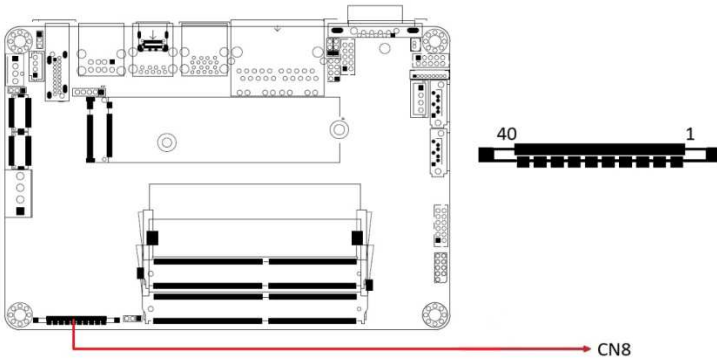

Remarks: KEL_SSL00-40S

Pin	Signal Name	Pin	Signal Name
1	eDP Vcc	21	TXN0
2	eDP Vcc	22	TXP1
3	eDP Vcc	23	Ground
4	eDP Vcc	24	AUXP
5	eDP Vcc	25	AUXN
6	Ground	26	NC
7	Ground	27	+3.3V
8	Ground	28	EDP BKLT (+12V)
9	Ground	29	NC
10	Hot Plug detect	30	Ground
11	Ground	31	+5V
12	TXN3	32	NC
13	TXP3	33	Back Light Control
14	Ground	34	Back Light Enable
15	TXN2	35	EDP BKLT (+12V)
16	TXP2	36	+3.3V
17	Ground	37	Ground
18	TXN1	38	NC
19	TXP1	39	NC
20	Ground	40	NC

2.5.2 Digital I/O Connector (J16)

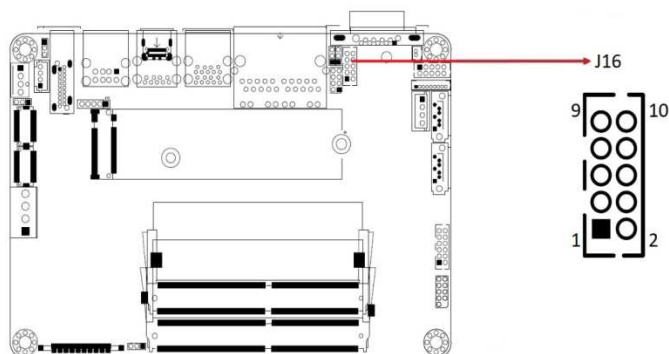

Remarks: HK_DF11-10S-PA66H

Pin	Signal Name	Pin	Signal Name
1	Ground	2	+5V
3	OUT3	4	OUT1
5	OUT2	6	OUT0
7	IN3	8	IN1
9	IN2	10	IN0

2.5.1 LVDS Backlight Connector (J14)

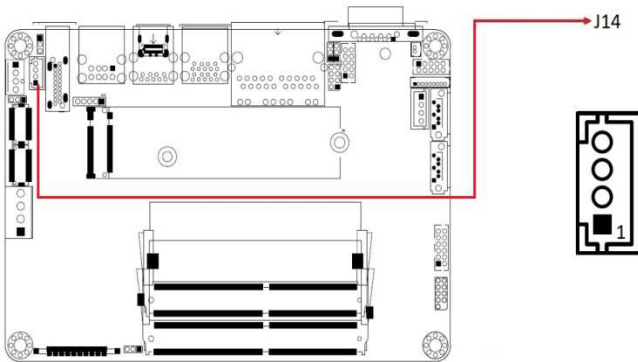

Remarks: E-CALL_0110-161-040

Pin	Signal Name
1	+12V
2	Backlight Enable
3	Brightness Control
4	Ground

2.5.3 LVDS CHB Connector (J7 - 2nd, J9 - 1st)

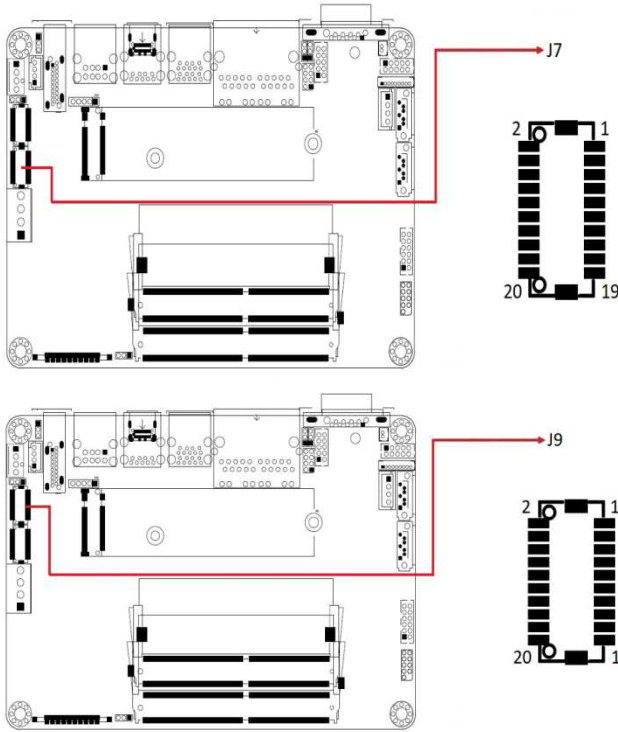

Remarks: HIROSE_DF20G-20DP-1V(56)

Pin	Signal Name	Pin	Signal Name
1	TX0P	2	TX0N
3	GND	4	GND
5	TX1P	6	TX1N
7	GND	8	GND
9	TX2P	10	TX2N
11	GND	12	GND
13	CLKP	14	CLKN
15	GND	16	GND
17	TX3P	18	TX3N
19	+3.3V	20	+3.3V

2.5.4 Audio Connector (J5)

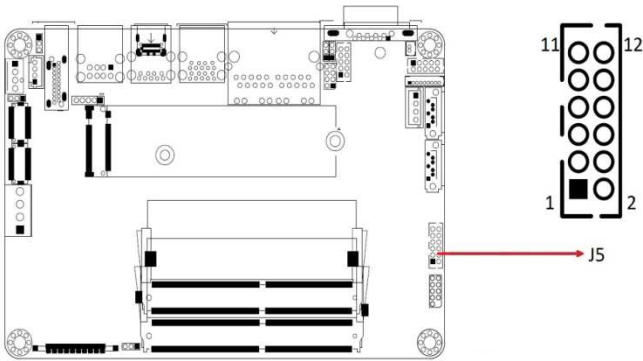

Remarks: HK_DF11-12S-PA66H

Pin	Signal Name	Pin	Signal Name
1	LINE OUT_L	2	LINE OUT_R
3	FRONT_JD	4	GND
5	LINE IN_L	6	LINE IN_R
7	LINE_JD	8	GND
9	MIC_L	10	MIC_R
11	MIC_JD	12	GND

2.5.5 Front Panel Settings Connector (J13)

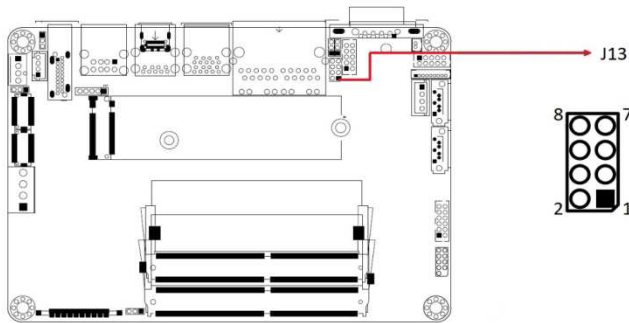

Remarks: E-CALL_0196-01-200-080

Pin	Signal Name	Pin	Signal Name
1	Power BTN	2	Power BTN
3	HDD LED+	4	HDD LED-
5	Reset BTN	6	Reset BTN
7	Power LED+	8	Power LED-

J18 is utilized for system indicators to provide light indication of the computer activities and switches to change the computer status. It provides interfaces for the following functions.

- ATX Power ON Switch (Pins 1 and 2)**

The 2 pins make an “ATX Power Supply On/Off Switch” for the system that connects to the power switch on the case. When pressed, the power switch will force the system to power on. When pressed again, it will power off the system.
- Hard Disk Drive LED Connector (Pins 3 and 4)**

This connector connects to the hard drive activity LED on control panel. This LED will flash when the HDD is being accessed.
- Reset Switch (Pins 5 and 6)**

The reset switch allows you to reset the system without turning the main power switch off and then on again. Orientation is not required when making a connection to this header.
- Power LED (Pins 7 and 8)**

This connector connects to the system power LED on control panel. This LED will light when the system turns on.

2.5.7 CPU Fan Power Connector (CPU_FAN1)

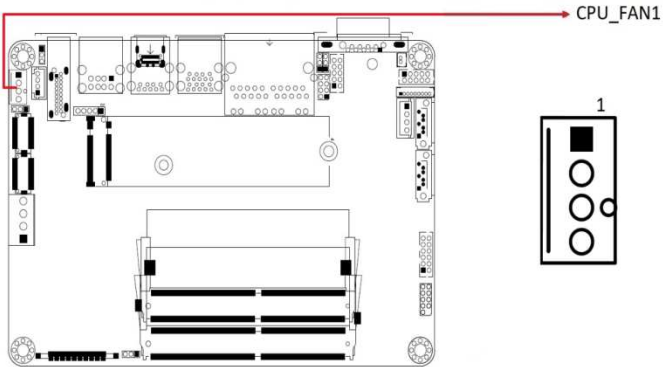

Pin	Signal Name	Pin	Signal Name
1	Ground	3	Rotation detection
2	+12V	4	Control

2.5.1 SATA Power Connector (J10)

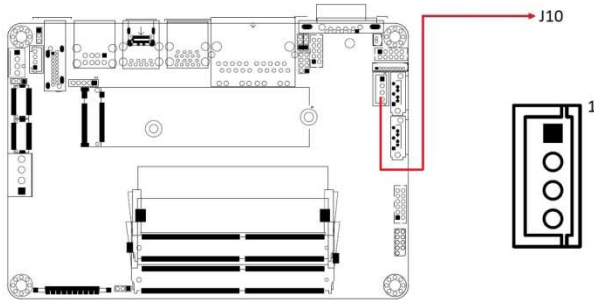

Remarks: E-CALL_0110-071-040

Pin	Signal Name
1	+5V
2	GND
3	GND
4	NC

2.5.2 DC-IN Power Connector (J6)

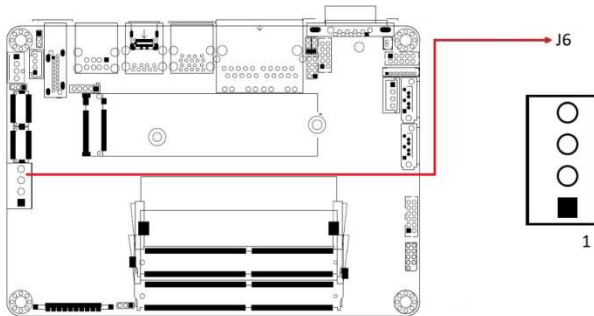

Remarks: Yimtex 532VW4STR

Pin	Signal Name
1	+12V~+24V
2	+12V~+24V
3	GND
4	GND

THIS PAGE IS INTENTIONALLY LEFT BLANK.

Chapter 3

Drivers Installation

This chapter introduces installation of the following drivers:

- AMD Ryzen V2000 Chipset Drivers
- AMD Ryzen V2000 Graphics Drivers
- Realtek High Definition Audio Driver
- LAN Driver Installation

3.1 Introduction

This section describes the installation procedures for software and drivers. The software and drivers are included with the motherboard.

3.2 AMD Ryzen V2000 Chipset Drivers Installation

1. Insert the disk enclosed in the package with the board. Click **AMD** on the left pane and then **AMD Ryzen V2000 Chipset Drivers** on the right pane.

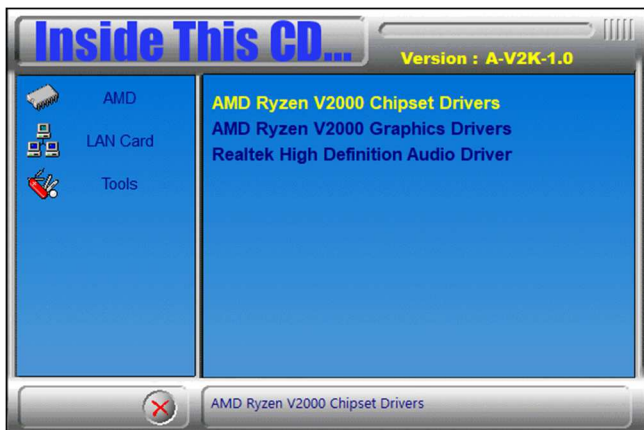

2. When the software installer screen appears, click **Install**.

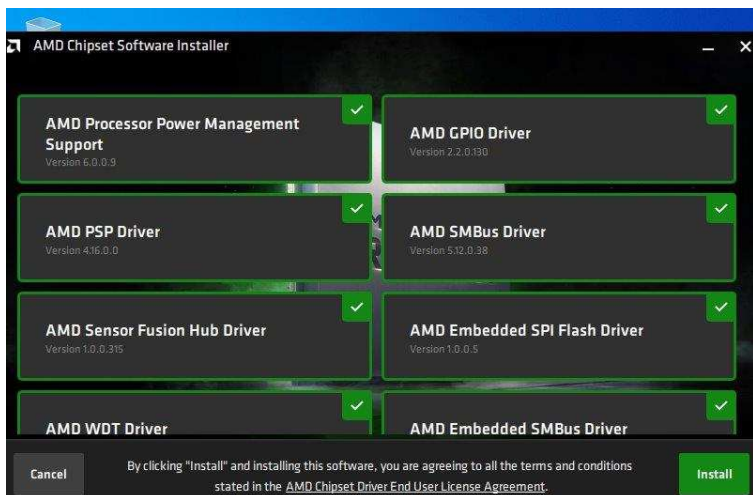

3. When the AMD Chipset Software has been installed successfully, click **Close**.



3.3 AMD Ryzen V2000 Graphics Drivers Installation

1. Click **AMD** on the left pane and then **AMD Ryzen V2000 Graphics Drivers** on the right pane.

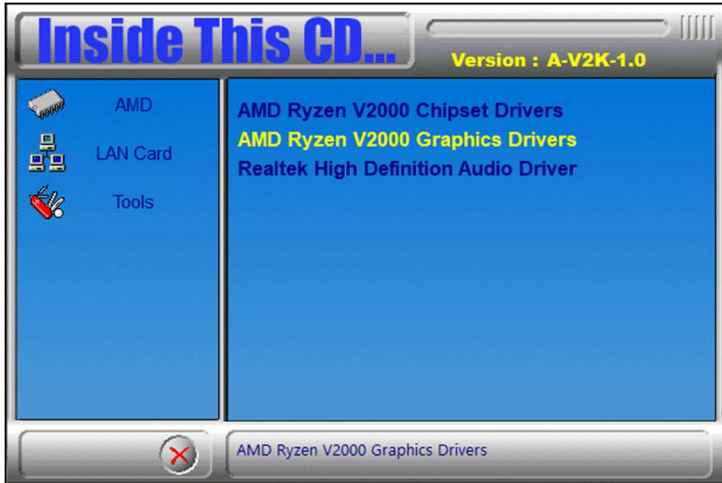

2. Click **Install** to agree to all the terms and conditions stated in the Radeon Software End User License Agreement.



3. The system is installing the AMD Display Drivers.



4. Click **Restart** as recommended to complete installation.

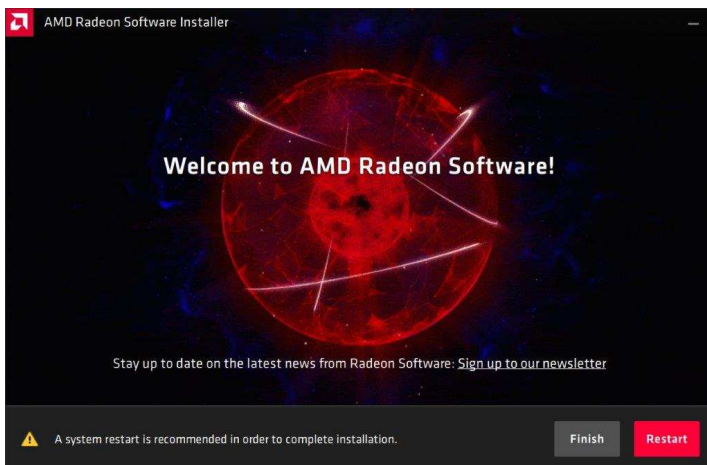

3.4 Realtek High Definition Audio Driver Installation

1. Click **AMD** on the left pane and then **Realtek High Definition Audio Driver** on the right pane.

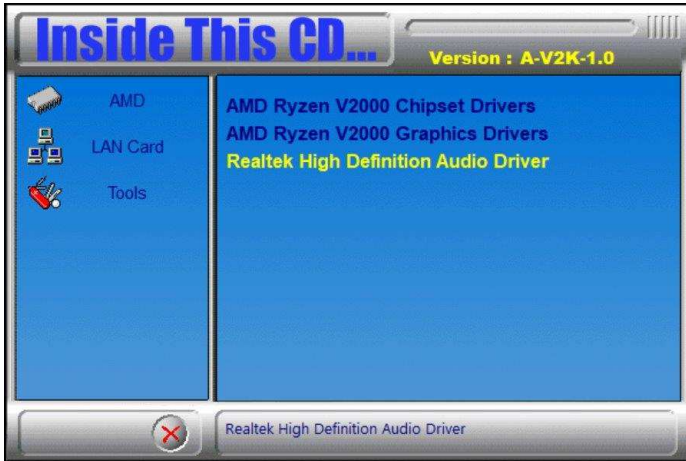

2. On the Welcome screen of the InstallShield Wizard, click **Next** to start the setup process.
3. When the driver has been successfully installed, click **Finish**.

Realtek High Definition Audio Driver Setup (4.27) R2.79

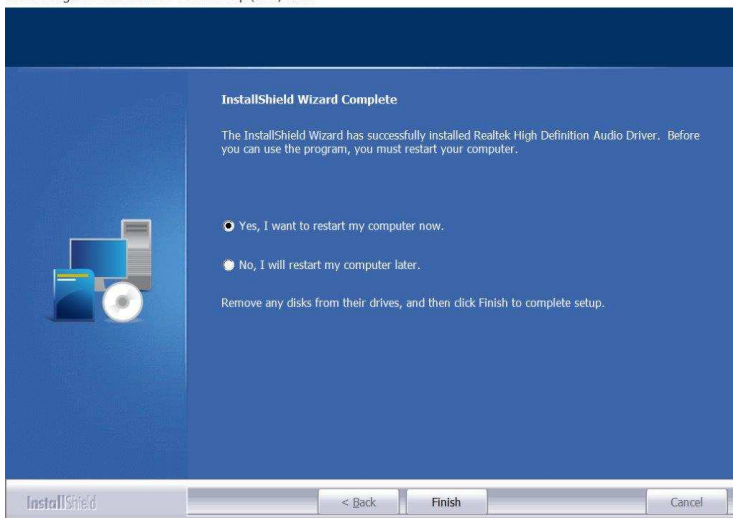

3.5 LAN Driver Installation

1. Click **LAN Card** on the left pane and then **Intel LAN Controller Drivers** on the right pane.



2. Click **Intel(R) I21x Gigabit Networks Drivers**.

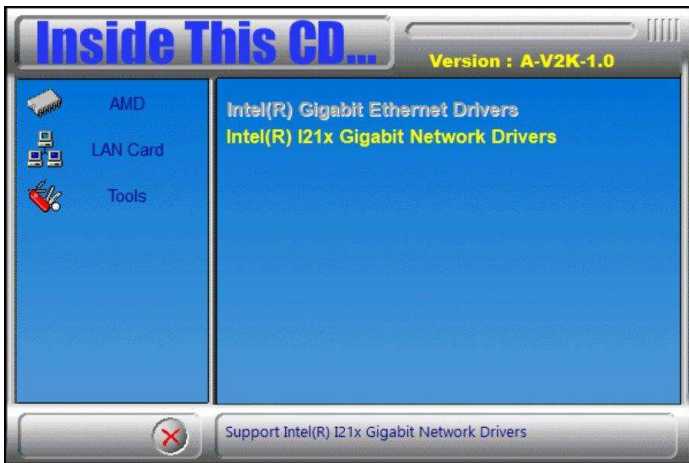

3. When the *Welcome* screen appears, click **Next**.

- Accept the license agreement and click **Next**.

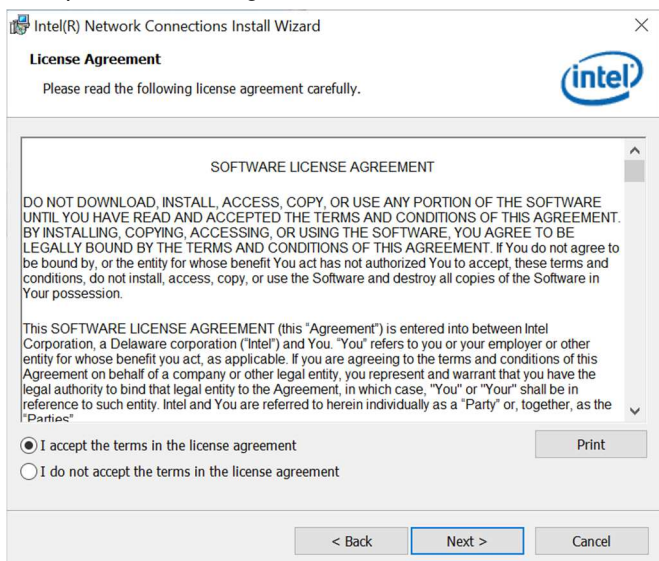

- On the *Setup Options* screen, tick the checkbox to select the desired driver(s) for installation. Then click **Next** to continue.

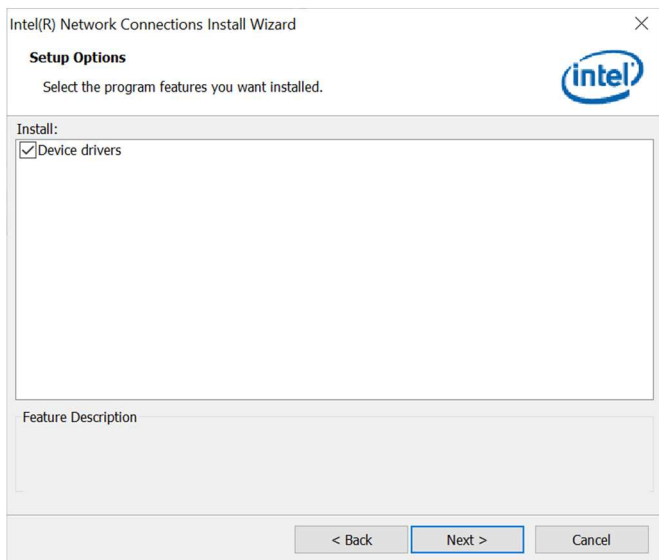

- The wizard is ready to begin installation. Click **Install**.
- When installation is complete, click **Finish**.

Chapter 4

BIOS Setup

This chapter describes the different settings available in the AMI BIOS that comes with the board. The topics covered in this chapter are as follows:

- Main Settings
- Advanced Settings
- Chipset Settings
- Boot Settings
- Security Settings
- Save & Exit

4.1 Introduction

The BIOS (Basic Input/Output System) installed in the ROM of your computer system supports AMD APU. The BIOS provides critical low-level support for standard devices such as disk drives, serial ports and parallel ports. It also provides password protection as well as special support for detailed fine-tuning of the chipset controlling the entire system.

4.2 BIOS Setup

The BIOS provides a Setup utility program for specifying the system configurations and settings. The BIOS ROM of the system stores the Setup utility. When you turn on the computer, the BIOS is immediately activated. Press the key immediately allows you to enter the Setup utility. If you are a little bit late pressing the key, POST (Power On Self Test) will continue with its test routines, thus preventing you from invoking the Setup.

If you still need to enter Setup, restart the system by pressing the "Reset" button or simultaneously pressing the <Ctrl>, <Alt> and <Delete> keys. You can also restart by turning the system Off and back On again.

The following message will appear on the screen:

```
Press <DEL> to Enter Setup
```

In general, press the arrow keys to highlight items, <Enter> to select, the <PgUp> and <PgDn> keys to change entries, <F1> for help, and <Esc> to quit.

When you enter the BIOS Setup utility, the *Main Menu* screen will appear on the screen. The Main Menu allows you to select from various setup functions and exit choices.

Warning: It is strongly recommended that you avoid making any changes to the chipset defaults.

These defaults have been carefully chosen by both AMI and your system manufacturer to provide the absolute maximum performance and reliability. Changing the defaults could make the system unstable and crash in some cases.

4.3 Main Settings



BIOS Setting	Description
System Date	Sets the date. Use the <Tab> key to switch between the data elements.
System Time	Set the time. Use the <Tab> key to switch between the data elements.

4.4 Advanced Settings

This section allows you to configure, improve your system and allows you to set up some system features according to your preference.

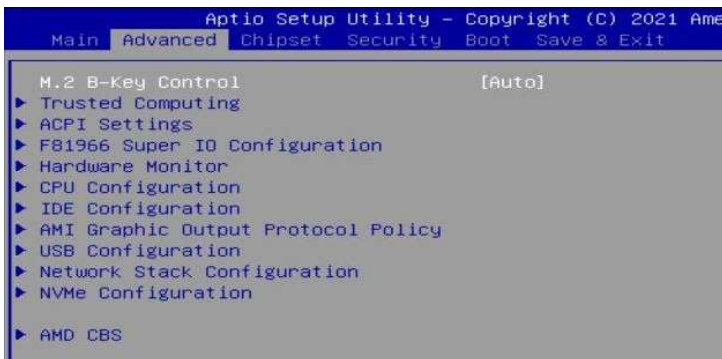

4.4.1 Trusted Computing



BIOS Setting	Description
Security Device Support	Option: Enable / Disable. OS will not show security device. TCG EFI protocol and INTIA interface will not be available.
SHA256 PCR Bank	Enables / Disables SHA256 PCR Bank.
Pending operation	Schedule an operation for the security device. Note: Your computer will reboot during restart in order to change state of security device.
Platform Hierarchy	Enables / Disables platform hierarchy.
Storage Hierarchy	Enables / Disables storage hierarchy.
Endorsement Hierarchy	Enables / Disables endorsement hierarchy.
TPM2.0 UEFI Spec Version	Selects the supported TCG version based on OS. <ul style="list-style-type: none"> • TCG_1_2: supports Windows 8 /10. • TCG_2: supports new TCG2 protocol and event format for Windows 10 or later.
Physical Presence Spec Version	Selects to show the PPI Spec Version (1.2 or 1.3) that the OS supports. Note: Some HCK tests might not support 1.3.
Device Select	TPM 1.2 will restrict support to TPM 1.2 devices only. TPM 2.0 will restrict support to TPM 2.0 devices only. Auto will support both with the default being set to TPM 2.0 devices if not found, and TPM 1.2 device will be enumerated.

4.4.2 ACPI Settings



BIOS Setting	Description
Enable ACPI Auto Configuration	Enables / Disables BIOS ACPI auto configuration.
Enable Hibernation	Enables / Disables the system ability to hibernate (OS/S4 Sleep State). This option may be not effective with some OS.
ACPI Sleep State	Selects an ACPI sleep state where the system will enter when the Suspend button is pressed.

4.4.3 LVDS Configuration



BIOS Setting	Description
LVDS Control	Enables / Disables LVDS.
Panel Color Depth	Options: 18 BIT, 24 BIT
LVDS Channel Type	Options: Single, Dual
Panel Type	Selects the resolution of your panel. Options: 800 x 480 / 800 x 600 / 1024 x 768 / 1024 x 800 / 1024 x 960 / 1280 x 1024 / 1366 x 768 / 1440 x 900 / 1600 x 900 / 1600 x 1200 / 1680 x1050 / 1920 x 1080 / 1920 x 1200
LVDS Backlight Control	Options: 0(Min), 1, 2, 3, 4, 5, 6, 7(Max)

4.4.4 F81804 Super IO Configuration

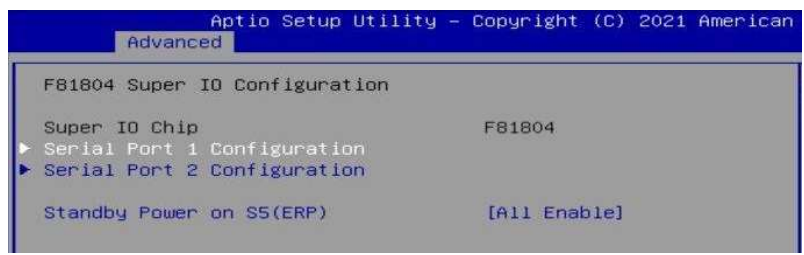

BIOS Setting	Description
Standby Power On S5 (ERP)	Enables / Disables the standby power.
Serial Port Configuration	Sets parameters of Serial Ports. Enables / Disables the serial port and select an optimal setting for the Super IO device.

Serial Port 1 Configuration

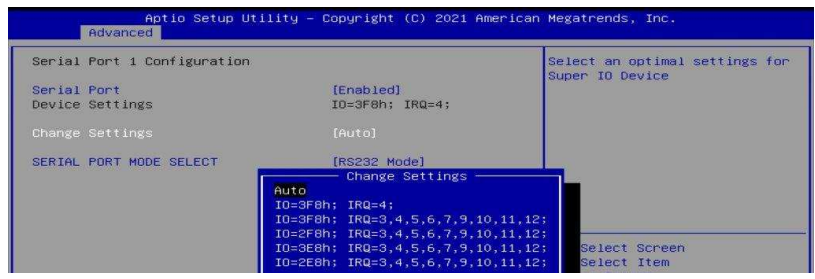

Serial Port 2 Configuration

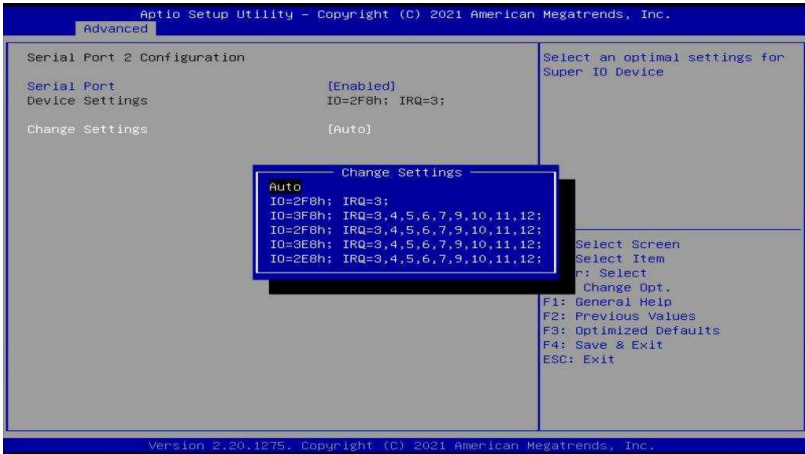
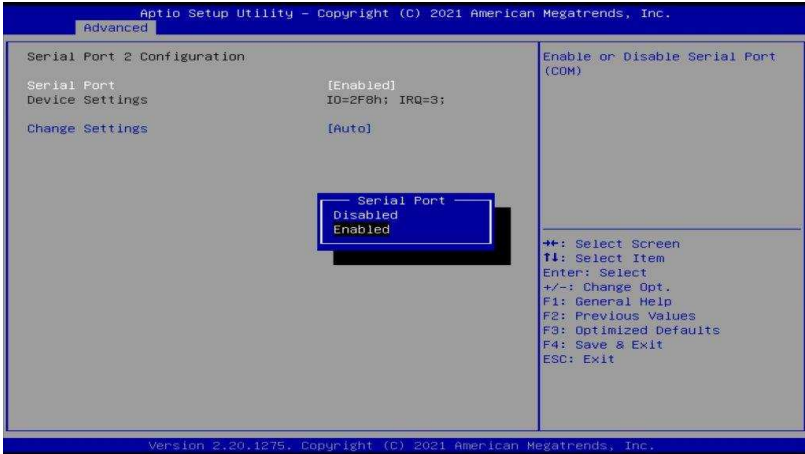

4.4.5 Hardware Monitor

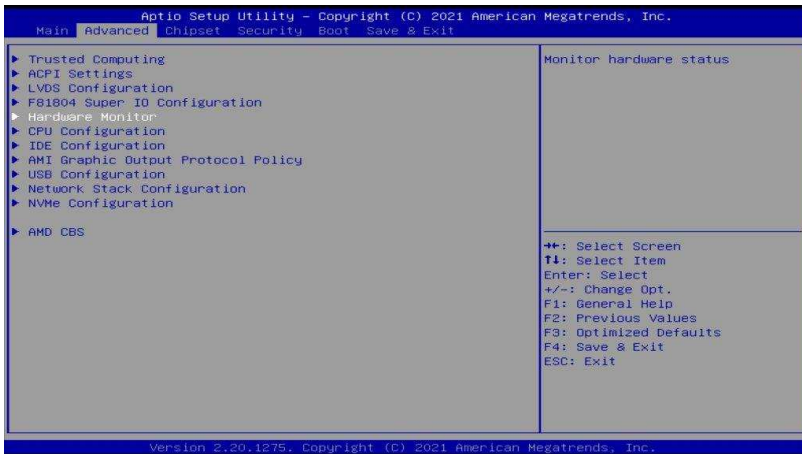

BIOS Setting	Description
CPU Fan Smart Fan Control	Enables / Disables the CPU smart fan feature. Options: Disabled / 50 °C / 60 °C / 70 °C / 80 °C
System Smart Fan Control	Enables / Disables the system smart fan feature. Options: Disabled / 50 °C / 60 °C / 70 °C / 80 °C
Temperatures / Voltages	These fields are the parameters of the hardware monitoring function feature of the motherboard. The values are read-only values as monitored by the system and show the PC health status.

4.4.6 CPU Configuration

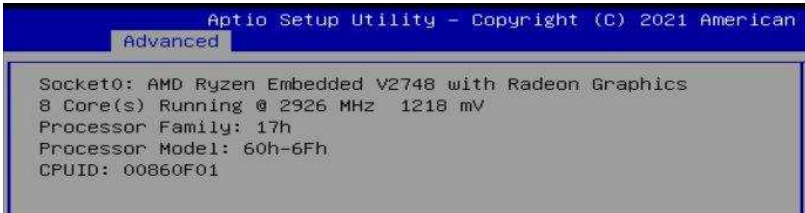
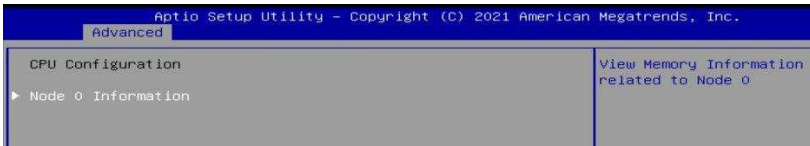
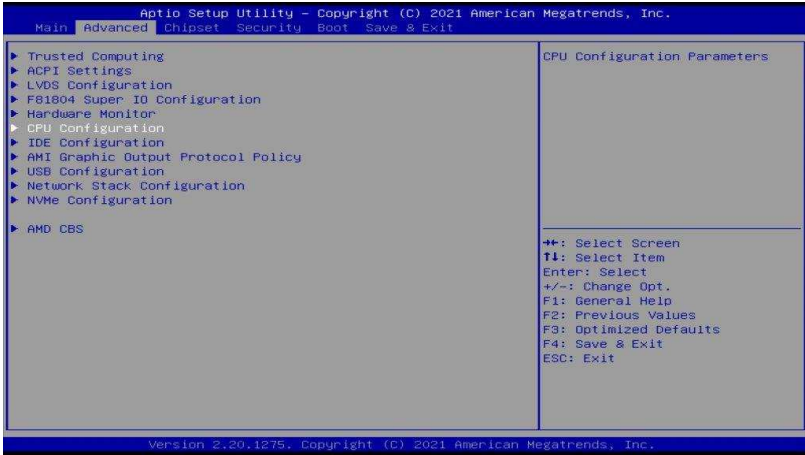

4.4.7 IDE Configuration

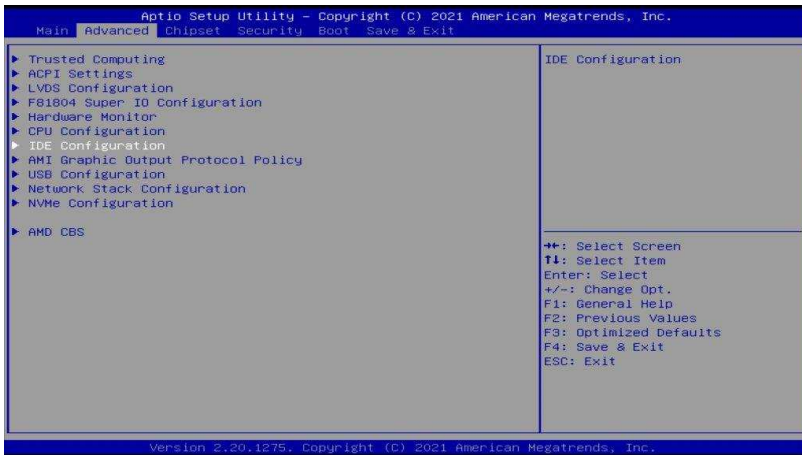

4.4.8 AMI Graphic Output Protocol Policy



4.4.9 USB Configuration

```

Aptio Setup Utility - Copyright (C) 20
Advanced
USB Configuration
USB Module Version                25
USB Controllers:
    2 XHCIs
USB Devices:
    1 Keyboard
Legacy USB Support                 [Enabled]
XHCI Hand-off                     [Enabled]
USB Mass Storage Driver Support   [Enabled]
USB hardware delays and time-outs:
USB transfer time-out             [20 sec]
Device reset time-out            [20 sec]
Device power-up delay            [Auto]

```

BIOS Setting	Description
Legacy USB Support	<p>Enables Legacy USB support.</p> <ul style="list-style-type: none"> Auto disables legacy support if there is no USB device connected. Disable keeps USB devices available only for EFI applications.
XHCI Hand-off	<p>This is a workaround for Oses without XHCI hand-off support. The XHCI ownership change should be claimed by XHCI driver.</p>
USB Mass Storage Driver Support	<p>Enables / Disables the support for USB mass storage driver.</p>
USB Transfer time-out	<p>The time-out value for control, bulk, and Interrupt transfers.</p> <p>Options: 1 sec / 5 sec / 10 sec / 20 sec</p>
Device reset time-out	<p>Seconds of delaying execution of start unit command to USB mass storage device.</p> <p>Options: 10 sec / 20 sec / 30 sec / 40 sec</p>
Device power-up delay	<p>The maximum time the device will take before it properly reports itself to the Host Controller.</p> <p>Auto uses default value for a Root port it is 100ms. But for a Hub port, the delay is taken from Hub descriptor.</p> <p>Options: Auto / Manual</p>

4.4.10 Network Stack Configuration



BIOS Setting	Description
Network Stack	Enable/Disable UEFI Network Stack
IPv4 PXE Support	Enable/Disable IPv4 PXE boot support. If disabled, IPv4 PXE boot support will not be available
IPv4 HTTP Support	Enable/Disable IPv4 HTTP boot support. If disabled, IPv4 HTTP boot support will not be available
IPv6 HTTP Support	Enable/Disable IPv6 HTTP boot support. If disabled, IPv6 HTTP boot support will not be available
IPv6 PXE Support	Enable/Disable IPv6 PXE boot support. If disabled, IPv6 PXE boot support will not be available
IPSEC Certificate	Support to Eable/Disable IPSEC certificate for lkey.
PXE boot wait time	Wait time in seconds to press ESC key to abort the PXE boot. Use either +/- or numeric keys to set the value
Media detect count	Number of times the presence of media will be checked. Use either +/- or numeric keys to set the value

4.4.11 NVMe Configuration

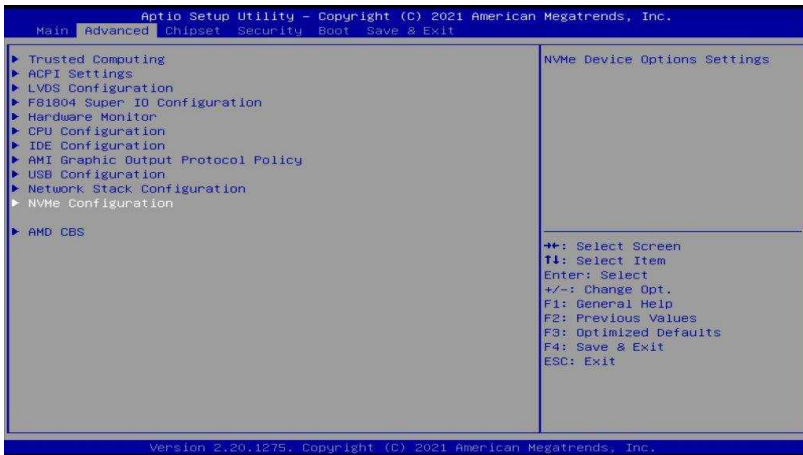

4.4.12 AMD CBS

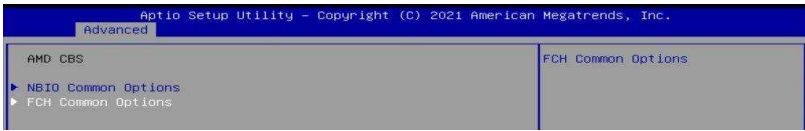
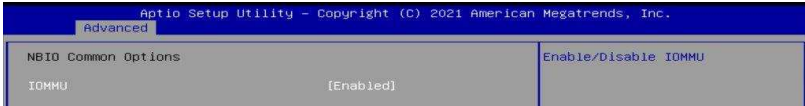

4.5 Chipset Settings

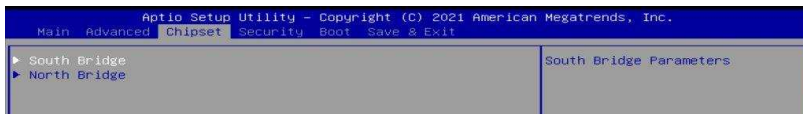

4.5.1 SB USB Configuration

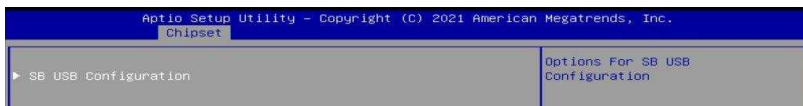

4.5.1.1. XHCI Ports



4.5.2 North Bridge Configuration

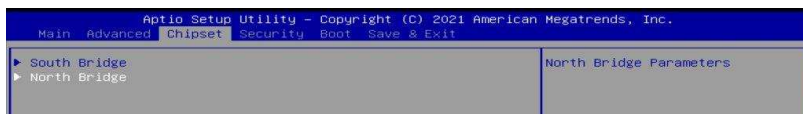

4.6 Security Settings

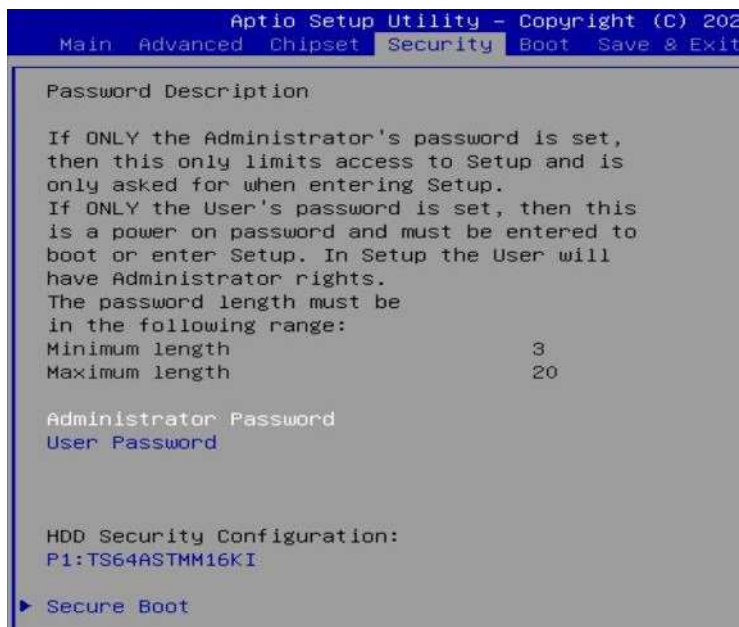

BIOS Setting	Description
Administrator Password	Sets an administrator password for the setup utility.
User Password	Sets a user password.
HDD Security Configuration	HDD Security Configuration for selected drive
Secure Boot	Secure Boot Configuration

BIOS Setting	Description
Secure Boot	Secure Boot feature is active if Secure Boot enabled. Platform Key(PK) is enrolled and the system is in user mode. The mode change requires platform reset.
Secure Boot Mode	Secure Boot mode options: Standard or Custom. In Custom mode, Secure Boot Policy variables can be configured by a physically present user without full authentication.
Restore Factory Keys	Force System to User Mode. Install factory default Secure Boot key databases.
Reset To Setup Mode	Delete all Secure Boot key databases from NVRAM
Key Management	Enables expert users to modify Secure Boot Policy variables without full authentication



4.7 Boot Settings



BIOS Setting	Description
Setup Prompt Timeout	Number of seconds to wait for setup activation key. 65535(0xFFFF) means indefinite waiting.
Bootup NumLock State	Selects the keyboard NumLock state.
Quiet Boot	Enables / Disables Quiet Boot option.
FIXED BOOT ORDER Priorities	Sets the system boot order.
UEFI Hardk Disk Drive BBS Priorities	Specifies the Boot Device Priority UEFI Hard Disk Drives
UEFI USB Key Drive BBS Priorities	Specifies the Boot Device Priority sequence from available UEFI USB Key Drives

4.8 Save & Exit Settings

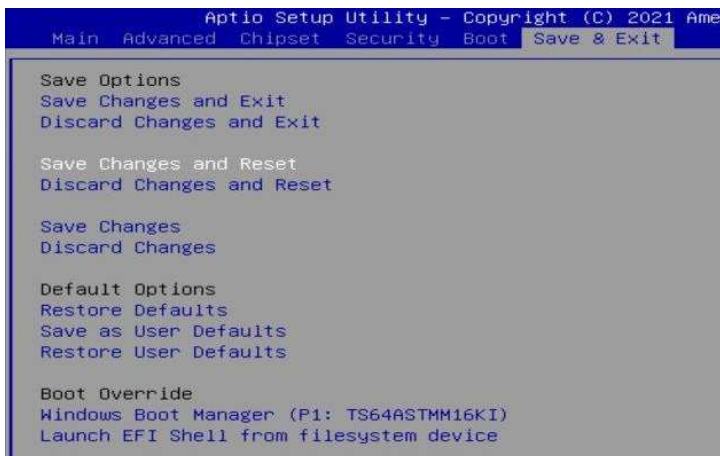

BIOS Setting	Description
Save Changes and Exit	Exits system setup after saving the changes.
Discard Changes and Exit	Exits system setup without saving any changes.
Save Changes and Reset	Resets the system after saving the changes.
Discard Changes and Reset	Resets system setup without saving any changes.
Save Changes	Saves changes done so far to any of the setup options.
Discard Changes	Discards changes done so far to any of the setup options.
Restore Defaults	Restores / Loads defaults values for all the setup options.
Save as User Defaults	Saves the changes done so far as User Defaults.
Restore User Defaults	Restores the user defaults to all the setup options.
Launch EFI Shell from filesystem device	Attempts to launch EFI Shell application (Shell.efi) from one of the available filesystem devices

THIS PAGE IS INTENTIONALLY LEFT BLANK.

Appendix

This section provides the mapping addresses of peripheral devices, the sample code of watchdog timer configuration, and types of on-board connectors.

A. I/O Port Address Map

Each peripheral device in the system is assigned a set of I/O port addresses which also becomes the identity of the device. The following table lists the I/O port addresses used.

Address	Device Description
0x00000A00-0x00000A0F	Motherboard resources
0x00000A10-0x00000A1F	Motherboard resources
0x00000E80-0x00000E8F	Motherboard resources
0x00000070-0x00000071	System CMOS/real time clock
0x0000DF00-0x0000DFFF	AMD Radeon(TM) Graphics
0x000003F8-0x000003FF	Communications Port (COM1)
0x000002F8-0x000002FF	Communications Port (COM2)
0x00000020-0x00000021	Programmable interrupt controller
0x000000A0-0x000000A1	Programmable interrupt controller
0x00000000-0x000003AF	PCI Express Root Complex
0x00000000-0x000003AF	Direct memory access controller
0x000003E0-0x00000CF7	PCI Express Root Complex
0x000003B0-0x000003DF	PCI Express Root Complex
0x00000D00-0x0000FFFF	PCI Express Root Complex
0x00000040-0x00000043	System timer
0x0000D000-0x0000DFFF	PCI Express Root Port
0x00000010-0x0000001F	Motherboard resources
0x00000022-0x0000003F	Motherboard resources
0x00000063-0x00000063	Motherboard resources
0x00000065-0x00000065	Motherboard resources
0x00000067-0x0000006F	Motherboard resources
0x00000072-0x0000007F	Motherboard resources
0x00000080-0x00000080	Motherboard resources
0x00000084-0x00000086	Motherboard resources
0x00000088-0x00000088	Motherboard resources
0x0000008C-0x0000008E	Motherboard resources

Address	Device Description
0x00000090-0x0000009F	Motherboard resources
0x000000A2-0x000000BF	Motherboard resources
0x000000B1-0x000000B1	Motherboard resources
0x000000E0-0x000000EF	Motherboard resources
0x000004D0-0x000004D1	Motherboard resources
0x0000040B-0x0000040B	Motherboard resources
0x000004D6-0x000004D6	Motherboard resources
0x00000C00-0x00000C01	Motherboard resources
0x00000C14-0x00000C14	Motherboard resources
0x00000C50-0x00000C51	Motherboard resources
0x00000C52-0x00000C52	Motherboard resources
0x00000C6C-0x00000C6C	Motherboard resources
0x00000C6F-0x00000C6F	Motherboard resources
0x00000CD0-0x00000CD1	Motherboard resources
0x00000CD2-0x00000CD3	Motherboard resources
0x00000CD4-0x00000CD5	Motherboard resources
0x00000CD6-0x00000CD7	Motherboard resources
0x00000CD8-0x00000CDF	Motherboard resources
0x00000800-0x0000089F	Motherboard resources
0x00000B00-0x00000B0F	Motherboard resources
0x00000B20-0x00000B3F	Motherboard resources
0x00000900-0x0000090F	Motherboard resources
0x00000910-0x0000091F	Motherboard resources
0x00000061-0x00000061	System speaker
0x0000F000-0x0000FFFF	PCI Express Root Port
0x0000E000-0x0000EFFF	PCI Express Root Port
0x00000081-0x00000083	Direct memory access controller
0x00000087-0x00000087	Direct memory access controller
0x00000089-0x0000008B	Direct memory access controller
0x0000008F-0x0000008F	Direct memory access controller
0x000000C0-0x000000DF	Direct memory access controller

B. Interrupt Request Lines (IRQ)

Peripheral devices use interrupt request lines to notify CPU for the service required. The following table shows the IRQ used by the devices on board.

Level	Function
IRQ 0	High precision event timer
IRQ 0	System timer
IRQ 8	High precision event timer
IRQ 7	AMD GPIO Controller
IRQ 4294967290	Standard SATA AHCI Controller
IRQ 4294967272~79	AMD USB 3.10 eXtensible Host Controller - 1.10 (Microsoft)
IRQ 4294967268~71	AMD Radeon(TM) Graphics
IRQ 4294967280~87	AMD USB 3.10 eXtensible Host Controller - 1.10 (Microsoft)
IRQ 4	Communications Port (COM1)
IRQ 3	Communications Port (COM2)
IRQ 4294967288~89	AMD PSP 10.0 Device
IRQ 39	AMD Audio CoProcessor
IRQ 39	High Definition Audio Controller
IRQ 55~204	Microsoft ACPI-Compliant System
IRQ 256~511	Microsoft ACPI-Compliant System
IRQ 1024	Trusted Platform Module 2.0
IRQ 37	AMD Sensor Fusion Hub
IRQ 36	High Definition Audio Controller
IRQ 4294967291~94	PCI Express Root Port

C. Onboard Connector Types

Function	Connector	Onboard Type	Compatible Mating Type for Reference
COM2 RS-232 Ports	J15	Hao Guo Xing Ye DF11-10S-PA66H	HRS DF11-10DS-2C
Audio	J5	Hao Guo Xing Ye DF11-12S-PA66H	Hirose DF11-12DS-2C
SATA HDD Power	J10	E-Call 0110-071-040	JST XHP-4
Digital I/O Connector	J16	Hao Guo Xing Ye DF11-10S-PA66H	HRS DF11-10DS-2C
LCD Backlight	J14	E-Call 0110-161-040	JST PHR-4.
LVDS	J7, J9	Hirose DF20G-20DP-1V	Hirose DF20A-20DS-1C
Front Panel Settings Connector	J13	Dupont 2.0 2*4 pin (Male)	Dupont 2.0 2*4 pin (Female)
eDP	CN8	KEL SSL00-40S	KEL SSL20-40S
DC-in Power Connector	J6	Yimtex 532VW4STR	JST VHR-4N
eDP Panel Power Selection	JP1	Dupont 2.0 3 pin (Male)	Dupont 2.0 3 pin (Female)
Clear CMOS Data	JBAT1	Dupont 2.0 3 pin (Male)	Dupont 2.0 3 pin (Female)

Our company network supports you worldwide with offices in Germany, Austria, Switzerland, the UK and the USA. For more information please contact:

Headquarters

Germany



FORTEC Elektronik AG

Augsburger Str. 2b
82110 Germering

Phone: +49 89 894450-0
E-Mail: info@fortecaq.de
Internet: www.fortecaq.de

Fortec Group Members

Austria



Distec GmbH Office Vienna

Nuschinggasse 12
1230 Wien

Phone: +43 1 8673492-0
E-Mail: info@distec.de
Internet: www.distec.de

Germany



Distec GmbH

Augsburger Str. 2b
82110 Germering

Phone: +49 89 894363-0
E-Mail: info@distec.de
Internet: www.distec.de

Switzerland



ALTRAC AG

Bahnhofstraße 3
5436 Würenlos

Phone: +41 44 7446111
E-Mail: info@altrac.ch
Internet: www.altrac.ch

United Kingdom



Display Technology Ltd.

Osprey House, 1 Osprey Court
Hinchbrooke Business Park
Huntingdon, Cambridgeshire, PE29 6FN

Phone: +44 1480 411600
E-Mail: info@displaytechnology.co.uk
Internet: www.displaytechnology.co.uk

USA



Apollo Display Technologies, Corp.

87 Raynor Avenue, Unit 1
Ronkonkoma, NY 11779

Phone: +1 631 5804360
E-Mail: info@apolloDisplays.com
Internet: www.apolloDisplays.com