



OUR GLOBAL
COMPETENCE
CENTRES

 APOLLO DISPLAY
TECHNOLOGIES



 DISTEC



 DISPLAY
TECHNOLOGY



Manual

ADVANTECH

PCM-9366

3,5" with Intel® Apollo Lake Pentium N4200, Celeron N3350 and Atom™ E3950/E3940/E3930 Processor

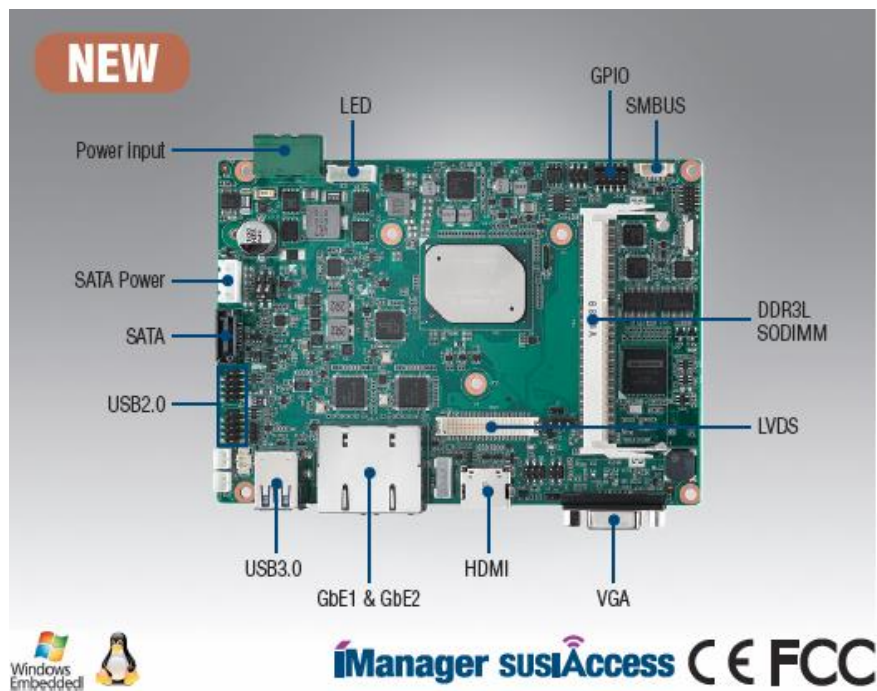

The information contained in this document has been carefully researched and is, to the best of our knowledge, accurate. However, we assume no liability for any product failures or damages, immediate or consequential, resulting from the use of the information provided herein. Our products are not intended for use in systems in which failures of product could result in personal injury. All trademarks mentioned herein are property of their respective owners. All specifications are subject to change without notice.

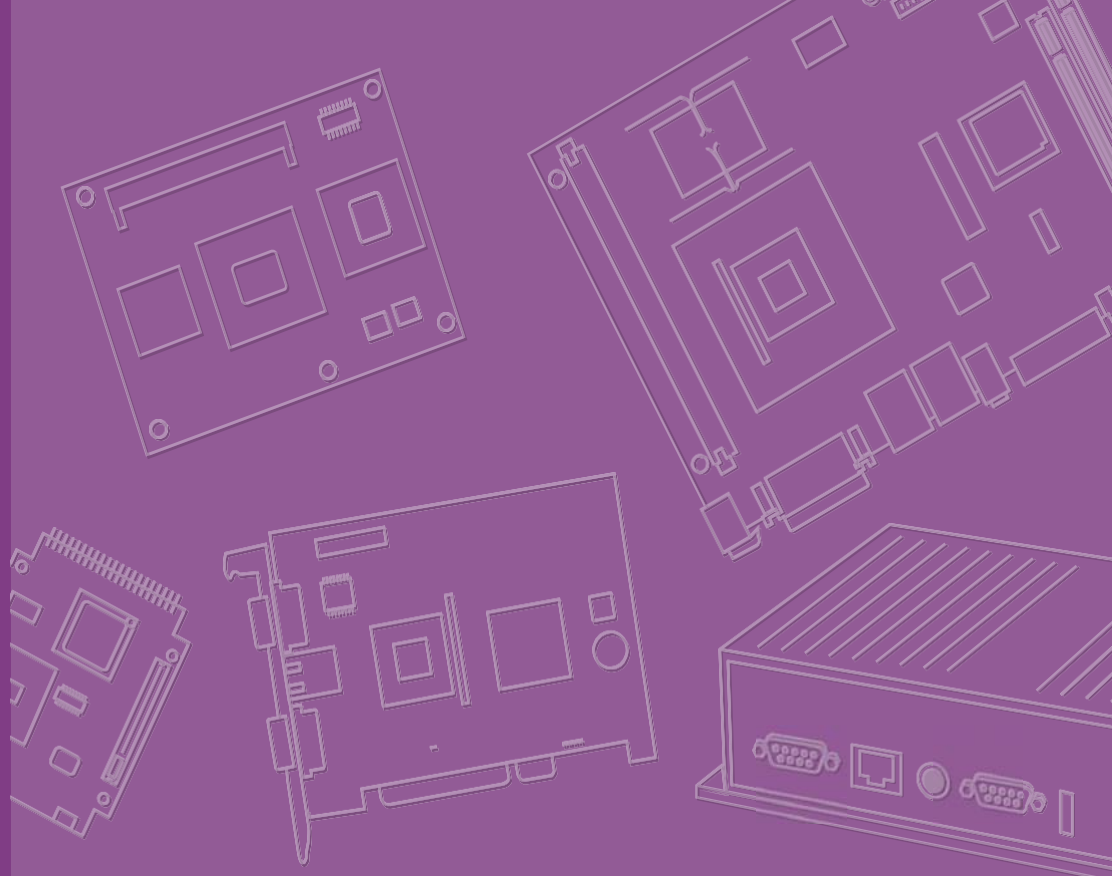

PCM-9366

Intel® Pentium N4200 Celeron N3350 & Atom™ E3950/E3940/E3930, DDR3L, HDMI, VGA, 48-bit LVDS/*eDP, 2GbE, M.2 Key E, Mini PCIe/mSATA, M.2 Key E, wide range power input, iManager

Copyright

The documentation and the software included with this product are copyrighted 2015 by Advantech Co., Ltd. All rights are reserved. Advantech Co., Ltd. reserves the right to make improvements in the products described in this manual at any time without notice. No part of this manual may be reproduced, copied, translated or transmitted in any form or by any means without the prior written permission of Advantech Co., Ltd. Information provided in this manual is intended to be accurate and reliable. However, Advantech Co., Ltd. assumes no responsibility for its use, nor for any infringements of the rights of third parties, which may result from its use.

Acknowledgements

Intel® is a trademark of Intel® Corporation.

AMI is a trademark of American Megatrends, Inc.

IBM, PC, PS/2 and VGA are trademarks of International Business Machines Corporation.

Microsoft Windows®, DirectX® is a registered trademark of Microsoft Corp.

All other product names or trademarks are properties of their respective owners.

For more information on this and other Advantech products, please visit our websites at:

<http://www.advantech.com>

<http://www.advantech.com/eplatform>

For technical support and service, please visit our support website at:

<http://support.advantech.com/>

This manual is for the PCM-9366.

Product Warranty (2 years)

Advantech warrants to you, the original purchaser, that each of its products will be free from defects in materials and workmanship for two years from the date of purchase.

This warranty does not apply to any products which have been repaired or altered by persons other than repair personnel authorized by Advantech, or which have been subject to misuse, abuse, accident or improper installation. Advantech assumes no liability under the terms of this warranty as a consequence of such events.

Because of Advantech's high quality-control standards and rigorous testing, most of our customers never need to use our repair service. If an Advantech product is defective, it will be repaired or replaced at no charge during the warranty period. For out-of-warranty repairs, you will be billed according to the cost of replacement materials, service time and freight. Please consult your dealer for more details.

If you think you have a defective product, follow these steps:

1. Collect all the information about the problem encountered. (For example, CPU speed, Advantech products used, other hardware and software used, etc.) Note anything abnormal and list any onscreen messages you get when the problem occurs.
2. Call your dealer and describe the problem. Please have your manual, product, and any helpful information readily available.
3. If your product is diagnosed as defective, obtain an RMA (return merchandise authorization) number from your dealer. This allows us to process your return more quickly.
4. Carefully pack the defective product, a fully-completed Repair and Replacement Order Card and a photocopy proof of purchase date (such as your sales receipt) in a shippable container. A product returned without proof of the purchase date is not eligible for warranty service.
5. Write the RMA number visibly on the outside of the package and ship it prepaid to your dealer.

Declaration of Conformity

CE

This product has passed the CE test for environmental specifications. Test conditions for passing included the equipment being operated within an industrial enclosure. In order to protect the product from being damaged by ESD (Electrostatic Discharge) and EMI leakage, we strongly recommend the use of CE-compliant industrial enclosure products.

FCC Class B

This equipment has been tested and found to comply with the limits for a Class B digital device, pursuant to part 15 of the FCC Rules. These limits are designed to provide reasonable protection against harmful interference when the equipment is operated in a commercial environment. This equipment generates, uses, and can radiate radio frequency energy and, if not installed and used in accordance with the instruction manual, may cause harmful interference to radio communications. Operation of this equipment in a residential area is likely to cause harmful interference in which case the user will be required to correct the interference at his own expense.

Caution! *There is a danger of a new battery exploding if it is incorrectly installed. Do not attempt to recharge, force open, or heat the battery. Replace the battery only with the same or equivalent type recommended by the manufacturer. Discard used batteries according to the manufacturer's instructions.*



Battery Information

Batteries, battery packs, and accumulators should not be disposed of as unsorted household waste.

Please use the public collection system to return, recycle, or treat them in compliance with the local regulations.



Technical Support and Assistance

1. Visit the Advantech website at <http://support.advantech.com> where you can find the latest information about the product.
2. Contact your distributor, sales representative, or Advantech's customer service center for technical support if you need additional assistance. Please have the following information ready before you call:
 - Product name and serial number
 - Description of your peripheral attachments
 - Description of your software (operating system, version, application software, etc.)
 - A complete description of the problem
 - The exact wording of any error messages

Packing List

Before you begin installing your card, please make sure that the following materials have been shipped:

- 1 x PCM-9366 SBC
- 1 x SATA Cable 32cm (p/n: 1700008941)
- 1 x SATA Power Cable 35cm (p/n: 1700018785)
- 1 x Audio Cable 20cm (p/n: 1700019584)
- 1 x COM Cable 22cm (p/n: 1701200220)
- 2 x USB cable 25cm (p/n:1700018730)
- 1 x COM2 cable 30cm (p/n:1700019414)
- 1 x Startup manual (p/n: 2006936600)
- 1 x Mini Jumper(10pcs package) (p/n: 9689000002)

If any of these items are missing or damaged, contact your distributor or sales representative immediately.

Optional Accessories

Part number	Description
-------------	-------------

Contents

Chapter 1	General Information	1
1.1	Introduction	2
1.2	Specifications	2
1.2.1	Functional Specifications	2
1.2.2	OS support	4
1.2.3	Mechanical Specifications	4
1.2.4	Electrical Specifications	4
1.2.5	Environmental	4
1.3	Block Diagram	5
1.4	Board layout: dimensions	5
	Figure 1.1 PCM-9366 Mechanical Drawing (Top Side)	5
	Figure 1.2 PCM-9366 Mechanical Drawing (Bottom Side)	6
	Figure 1.3 PCM-9366 Mechanical Drawing (Coastline)	6
Chapter 2	Installation	7
2.1	Jumpers & Switches	8
	Table 2.1: Jumpers & Switches	8
2.2	Connectors	8
	Table 2.2: Connectors	8
2.3	Locating Connectors	9
	Figure 2.1 PCM-9366 Connector Locations (Top Side)	9
	Figure 2.2 PCM-9366 Connector Locations (Bottom Side)	9
2.4	Setting Jumpers	10
2.4.1	Clear CMOS (J1)	10
	Table 2.3: Clear CMOS (J1)	10
2.4.2	Auto Power On Setting (J3)	10
	Table 2.4: Auto Power On Setting (J3)	10
2.4.3	LCD Power (J4)	11
	Table 2.5: LVDS1 Power (J4)	11
2.4.4	LVDS VCON Setting (J5)	11
	Table 2.6: LVDS2 Power (J5)	11
Chapter 3	AMI BIOS Setup	13
3.1	Entering Setup	15
3.1.1	Main Setup	15
3.1.2	Advanced BIOS Features Setup	16
3.1.3	Chipset Configuration	28
3.1.4	Security	37
3.1.5	Boot	38
3.1.6	Save & Exit	39
Appendix A	Pin Assignments	41
A.1	Jumper List	42
A.2	Connector Pin Definition	43
Appendix B	System Assignments	65
B.1	System I/O Ports	66

B.2	1st MB Memory Map	66
	Table B.2: 1st MB Memory Map	66
B.3	Interrupt Assignments	67
	Table B.3: Interrupt assignments	67

Appendix D **EC Watchdog Timer Sample Code .. 69**

D.1	EC Watchdog Timer sample code	70
-----	-------------------------------------	----

Chapter 1

General Information

This chapter gives background information on the PCM-9366.

Sections include:

- Introduction
- Specifications
- Block diagram
- Board layout and dimensions

1.1 Introduction

PCM-9366 is 3.5" form factor (146 x 102 mm) and powered by the latest generation of Intel® Pentium N4200 Celeron N3350 & Atom™ E3950/E3940/E3930 processors which have low power features but also good performance computing, especially for multimedia capabilities compared to earlier generations. Meanwhile, PCM-9366 offers flexible expansion possibilities: M.2 key E, full-size mSATA and 9-36V wide range power input.

PCM-9366 supports various display interfaces including HDMI, VGA, 48-bit LVDS/*eDP, and rich I/O: 2 GbE, rich I/O: 4COM, SATA, USB3.0, SMBus/I2C (optional), 2 8bit GPIO, 2 CANBUS.

1.2 Specifications

1.2.1 Functional Specifications

■ Processor:

- Intel® Pentium N4200 1.1 GHz (burst frequency 2.5GHz) Quad Core, Four Threads
- Celeron® N3350 1.1(burst frequency 2.4GHZ), Dual Core (burst frequency 2.42GHz), Quad Cores, Four Threads
- Atom™ E3950/40/30,1.6/1.6/1.3GHz, Quad/Quad/Dual Cores, Two Threads
- Cache Hierarchy
 - * 32 KB 8-way L1 instruction cache and 24 KB 6-way L1 data cache per core
 - * 1 MB, 16-way L2 cache, shared per two cores
- Supported C-states: C0, C1, C6, C7
- Advanced Technologies
 - * Intel® Virtualization Technology (VT-x)
 - * Intel® 64 Architecture
 - * Enhanced Intel SpeedStep Technology
 - * Intel® Trusted Execution Engine (TXE)
- Power Management
 - * ACPI 5.0
 - * System sleep states: S0, S3, S4, S5

■ System Memory Support

- Dual Channel ECC, DDR3L SODIMM up to 8GB
- 64 bit data bus
- 2x64 DDR3L 1867
- 4x32 LPDDR4 2400
- 38.4 GB/s (@2400 MT/s); 29.9 GB/s (@1867 MT/s)
- Aggressive power management to reduce power consumption

■ Graphic and Media Engine

- Intel® 9th generation (Gen 9) graphics and media encode/decode engine
- GFX:
- Graphic Features:
 - * 3D HW Acceleration: DirectX* 11.3/12,
 - * 4K Decode for HEVC4, H.264, VP8;

- * 4K Encode for H.264, VP8
- Multi-display interfaces: VGA, /HDMI (default)/(DP*), 48-bit LVDS/eDP (default LVDS). MIOe's DisplayPort interface is shared with DisplayPort on rear I/O.
 - * Supports Extend/ Clone Mode with multi-display device
 - * Dual display: any two combination between VGA, /HDMI/DP/MIOe's DisplayPort, LVDS/eDP
- Specification and Resolution
 - * VGA port: CH7517A-BF Maximum Resolution up to 1920x1200
 - * or DP*-DP 1.2a (4096x2160@60Hz)/1.4b (3840x2160@30Hz)
 - * eDP v1.4 4096x2160@ 60Hz / LVDS 48bit:
 - * Inverter power: 1A @ 5V/12V
- 3D HW Acceleration: OpenGL* 4.2, DirectX* 12, OpenCL* 2.0
- HW Video Decode: H.264, VC-1, WMV9, H.265/HEVC, VP8, VP9, JPEG/ MJPEG
- HW Video Encode: H.264, MVC, H.265/HEVC, VP8, VP9, JPEG/MJPEG
- **Gigabit Ethernet**
 - Controller: Intel® i210
 - * 10/100/1000 BASE-T
 - * IEEE 802.3az Energy Efficient Ethernet (EEE), which defines Low Power Idle (LPI) state
 - * IEEE 1588/802.1AS precision time synchronization
 - * 9.5 KB Jumbo frames supported (Full-duplex)
 - * Flow Control supported
 - * Magic packet wake-up enable with unique MAC address
- **Peripheral interface**
 - DMA operation
 - * SATA Power: 5V / 12V
 - 2 x USB 3.0 & 4 x USB 2.0
 - * Two USB3.0 on rear I/O, four internal USB2.0
 - * USB3.0 SuperSpeed (SS), implements xHCI software host controller interface
 - * Multiplexed with EHCI controller that are High-Speed/Full-Speed (HS/FS)
 - * USB source: USB3.0 and USB2.0's dual port on rear I/O's USB signal directly from CPU, internal USB + mini PCIe
 - * Support wake-up from sleeping state S3
 - * Power supply: 0.5A @ 5V for USB2.0, 1A @ 5V for USB3.0
 - 2 RS-232 for COM1/2, 2 RS-232/422/485 for COM3/4 (ESD protection: air gap ± 15 kV, contact ± 8 kV)
 - 16-bit Programmable General Purpose Input/ Output from iManager (5V tolerance)
 - 1 SMBus/I2C (optional) channel from iManager
 - Watchdog timer: Output System Reset, Programmable counter from 1 ~ 255 minutes/ seconds
 - Mini PCIe / mSATA
 - * 1 Full-size mSATA (with SATA and USB interface)
 - * Power supply: 1.1 A @ 3.3 V, 0.375 A @ 1.5 V
 - M.2 Key E

1 M.2 Key E (2230) slot (with PCIe and USB interface)

■ **High Definition Audio:**

- Intel® High Definition Audio Interface
- High Definition Audio Codec with Realtek proprietary loss-less content protection technology
- Supports 1 Line-input, 1 Line output, 1 Mic-input

■ **BIOS**

- AMI UEFI 64 Mbit, BIOS for 64 or 32bit is different, default version is for 64bit
- Default setting is UEFI boot

1.2.2 OS support

PCM-9366 supports Win10 (support UEFI mode), Linux Yocto Project BSP, VxWorks, Android 64 bit (Support by request).

For further information about OS support of PCM-9366, please visit Advantech website: <http://support.advantech.com.tw/> or contact the technical support center.

1.2.3 Mechanical Specifications

- **Dimensions:** 146 x 102 mm (5.7 x 4 inches)
- **Height:** top side 19.5mm, PCB 1.6mm, bottom side 7.8mm, total 28.9mm
- **Weight:** 0.5 kg (reference weight of total package)

1.2.4 Electrical Specifications

- **Power Requirement:** 9-36V wide range DC \pm 10% power input
- **Power Consumption:**
 - Max load: E3950: 1.16A @ 12V (13.92W)
 - Idle mode: E3950: 0.37A @ 12V (4.44W)
- **Power Consumption Conditions:**
 - Test software: 3DMark 2006
 - Max. load: Measure the maximum current value which system under maximum load (CPU: Top speed, RAM & Graphic: Full loading)
 - Idle mode: Measure the current value when system in windows mode and without running any program
- **RTC Battery:**
 - Typical Voltage: 3.0 V
 - Normal discharge capacity: 210 mAh

1.2.5 Environmental

- **Operating Temperature:** 0 ~ 60°C (32 ~ 140°F)
- **Operating Humidity:** 40°C @ 95% RH Non-Condensing
- **Storage Temperature:** Storage temperature: -40~85°C
- **Storage Humidity:** Relative humidity: 95% @ 60°C

1.3 Block Diagram

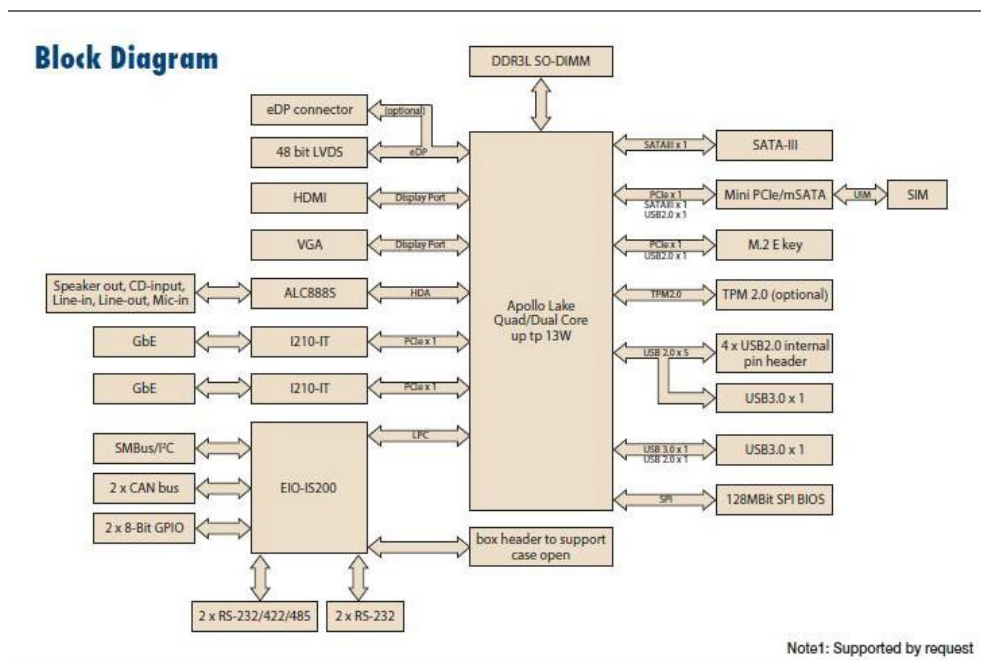

1.4 Board layout: dimensions

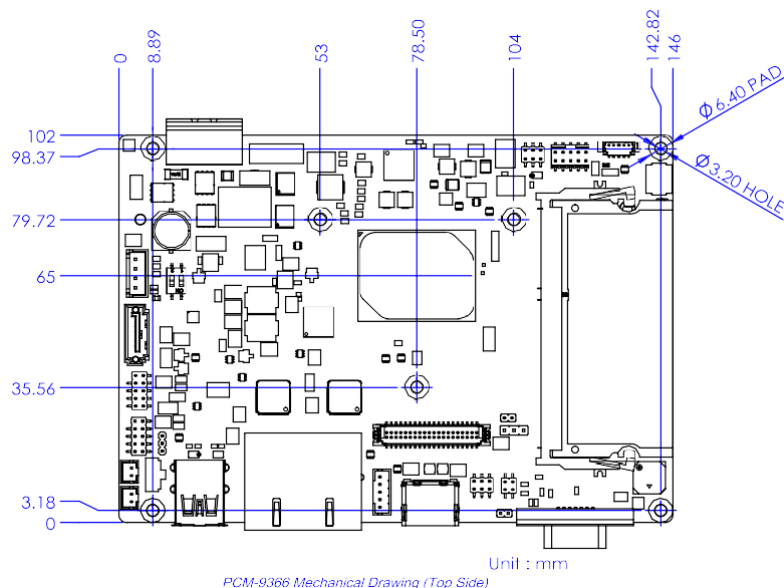
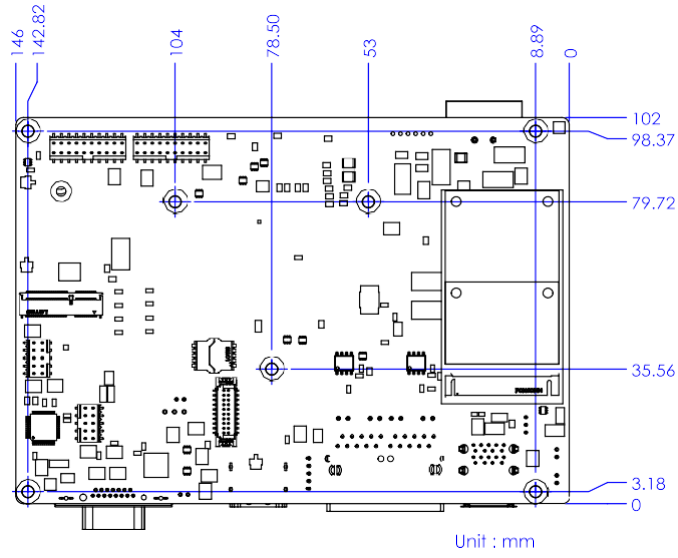
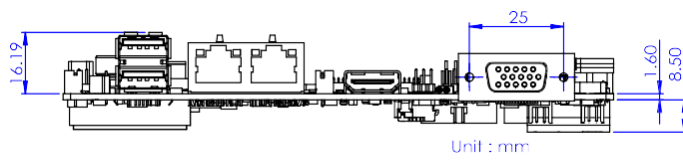

Figure 1.1 PCM-9366 Mechanical Drawing (Top Side)



PCM-9366 Mechanical Drawing (Bottom Side)

Figure 1.2 PCM-9366 Mechanical Drawing (Bottom Side)



PCM-9366 Mechanical Drawing (Side View)

Figure 1.3 PCM-9366 Mechanical Drawing (Coastline)

Chapter 2

Installation

This chapter explains the setup procedures of the PCM-9366 hardware, including instructions on setting jumpers and connecting peripherals, switches and indicators. Be sure to read all safety precautions before you begin the installation procedure.

2.1 Jumpers & Switches

The PCM-9366 has a number of jumpers that allow you to configure your system to suit your application. The table below lists the functions of the various jumpers.

Table 2.1: Jumpers & Switches

J1	Clear CMOS
J3	Auto Power On Setting
J4	LCD Power
J5	LVDS VCON Setting

2.2 Connectors

Onboard connectors link the PCM-9366 to external devices such as hard disk drives, a keyboard, or floppy drives. The table below lists the function of each of the connectors.

Table 2.2: Connectors

Label	Function
J2	CASE OPEN
CN1	Power Input
CN3	Battery
CN4	SODIMMDDR3_204
CN5	IS200 Debug Port
CN6	CAN1/CAN2
CN7	for SW debug
CN8	Power Switch
CN9	Reset
CN10	RS232/422/485 *2 (COM3/COM4)
CN11	RS232 * 2 (COM1/COM2)
CN12	Audio
CN13	eDP
CN14	HDMI
CN16	LAN
CN18	VGA
CN19	Inverter Power Output
CN20	48-bit LVDS Panel
CN21	M.2 Key E
CN22	Full size mSATA
CN23	Internal USB
CN24	Internal USB
CN25	External USB3.0
CN26	SATA
CN27	HDD & PWR LED
CN28	LPC Debug Port
CN29	SATA Power
CN30	GPIO
CN31	GPIO
CN32	SMBus/I2C (optional)
CN33	SIM

2.3 Locating Connectors

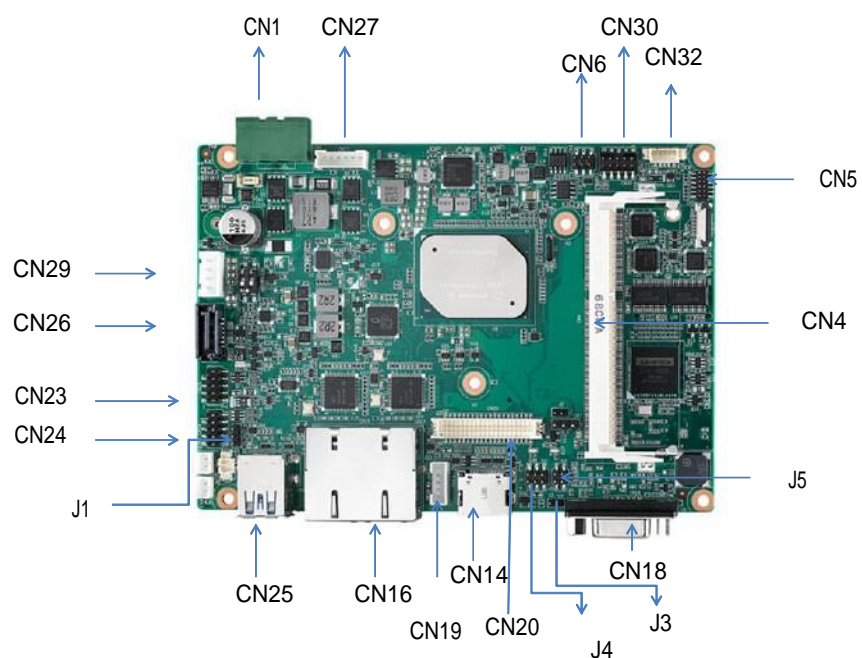

Figure 2.1 PCM-9366 Connector Locations (Top Side)

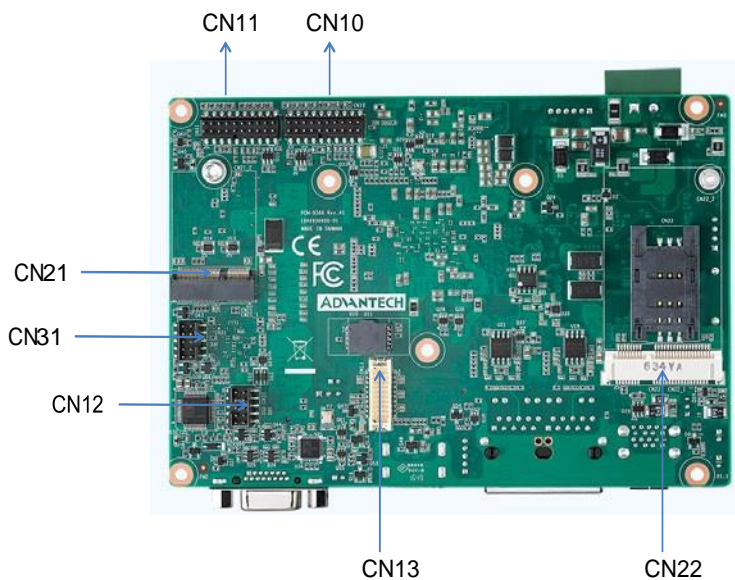
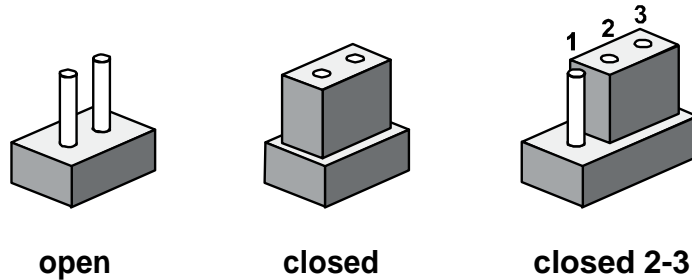

Figure 2.2 PCM-9366 Connector Locations (Bottom Side)

2.4 Setting Jumpers

You may configure your card to match the needs of your application by setting jumpers. A jumper is a metal bridge used to close an electric circuit. It consists of two metal pins and a small metal clip (often protected by a plastic cover) that slides over the pins to connect them. To “close” a jumper, you connect the pins with the clip. To “open” a jumper, you remove the clip. Sometimes a jumper will have three pins, labeled 1, 2 and 3. In this case you would connect either pins 1 and 2, or 2 and 3.

The jumper settings are schematically depicted in this manual as follows:



A pair of needle-nose pliers may be helpful when working with jumpers. If you have any doubts about the best hardware configuration for your application, contact your local distributor or sales representative before you make any changes. Generally, you simply need a standard cable to make most connections.

2.4.1 Clear CMOS (J1)



Table 2.3: Clear CMOS (J1)

Setting	Function
(1-2)*	Normal (default)
(2-3)	Clear CMOS

2.4.2 Auto Power On Setting (J3)



Table 2.4: Auto Power On Setting (J3)

Setting	Function
NC	Power Button for Power On
(1-2)*	Auto Power On

* Default

2.4.3 LCD Power (J4)

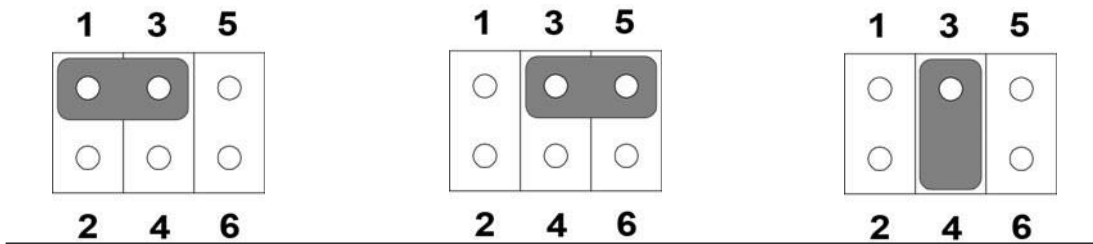

Table 2.5: LVDS1 Power (J4)

Setting	Function
(1-3)*	+3.3V (default)
(3-5)	+5V
(3-4)	+12V

2.4.4 LVDS VCON Setting (J5)

Table 2.6: LVDS2 Power (J5)

Setting	Function
(1-2)*	3.3V High for VCON on LVDS
(1-3)	Low for VCON on LVDS
(3-4)	+12V

Chapter 3

AMI BIOS Setup

AMIBIOS has been integrated into a plethora of motherboards for decades. With the AMIBIOS Setup program, you can modify BIOS settings and control the various system features. This chapter describes the basic navigation of the PCM-9366 BIOS setup screens.



AMI BIOS ROM has a built-in Setup program that allows users to modify the basic system configuration. This information is stored in battery-backed CMOS so it retains the Setup information when the power is turned off.

3.1 Entering Setup

Turn on the computer and check for the patch code. If there is a number assigned to the patch code, it means that the BIOS supports your CPU. If there is no number assigned to the patch code, please contact an Advantech application engineer to obtain an up-to-date patch code file. This will ensure that your CPU's system status is valid. After ensuring that you have a number assigned to the patch code, press and you will immediately be allowed to enter Setup.

3.1.1 Main Setup

When you first enter the BIOS Setup Utility, you will encounter the Main setup screen. You can always return to the Main setup screen by selecting the Main tab. There are two Main Setup options. They are described in this section. The Main BIOS Setup screen is shown below.



The Main BIOS setup screen has two main frames. The left frame displays all the options that can be configured. Grayed-out options cannot be configured; options in blue can. The right frame displays the key legend.

Above the key legend is an area reserved for a text message. When an option is selected in the left frame, it is highlighted in white. Often a text message will accompany it.

- **System time / System date**

Use this option to change the system time and date. Highlight System Time or System Date using the <Arrow> keys. Enter new values through the keyboard. Press the <Tab> key or the <Arrow> keys to move between fields. The date must be entered in MM/DD/YY format. The time must be entered in HH:MM:SS format.

3.1.2 Advanced BIOS Features Setup

Select the Advanced tab from the PCM-9366 setup screen to enter the Advanced BIOS Setup screen. You can select any of the items in the left frame of the screen, such as CPU Configuration, to go to the sub menu for that item. You can display an Advanced BIOS Setup option by highlighting it using the <Arrow> keys. All Advanced BIOS Setup options are described in this section. The Advanced BIOS Setup screens is shown below. The sub menus are described on the following pages.

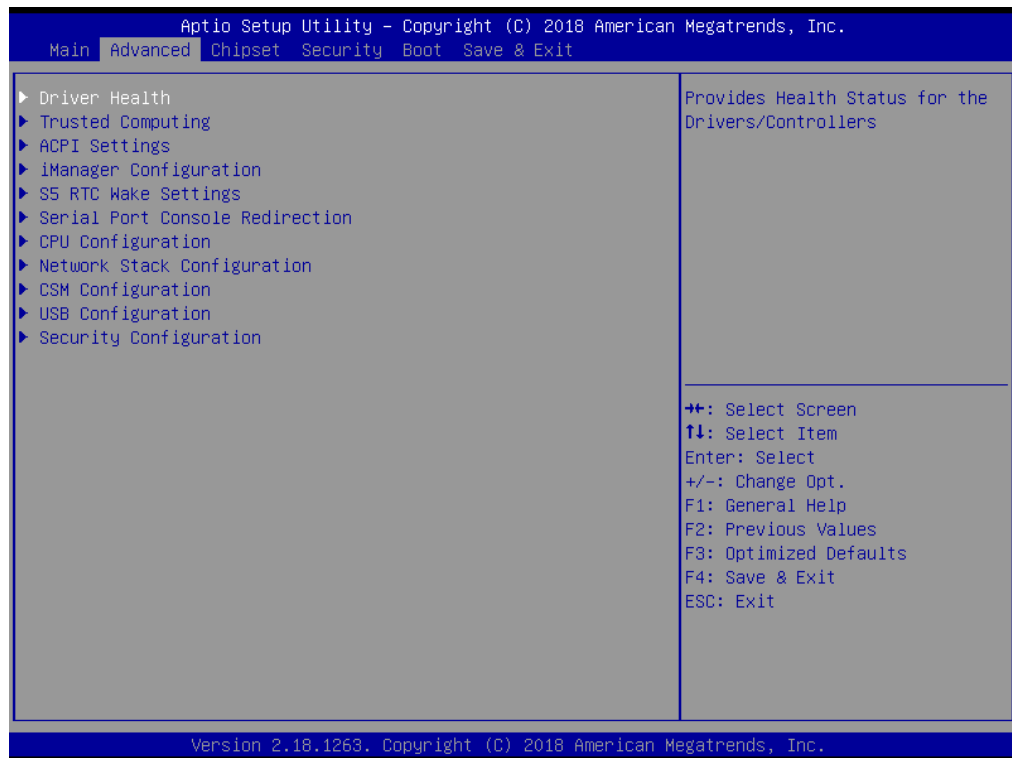

3.1.2.1 Driver Health



Provide Health Status for the Drivers/Controllers.

3.1.2.2 Trusted Computing



- **Security Device Support**
Enable or disable BIOS support for security device.
- **SHA-1 PCR Bank**
Enable or Disable SHA-1 PCR Bank.
- **SHA256 PCR Bank**
Enable or Disable SHA256 PCR Bank.
- **Pending operation**
Schedule an Operation for the Security Device.
- **Platform Hierarchy**
Enable or Disable Platform Hierarchy.
- **Storage Hierarchy**
Enable or Disable Storage Hierarchy.
- **Endorsement Hierarchy**
Enable or Disable Endorsement Hierarchy.
- **TPM 2.0 UEFI Spec Version**
Select the TCG2 Spec Version Support.
- **Physical Presence Spec Version**
Select to Tell O.S. to support PPI Spec Version 1.2 or 1.3.
- **Device Select**
TPM 1.2 will restrict support to TPM 1.2 devices, TPM 2.0 will restrict support to TPM 2.0 devices.

3.1.2.3 ACPI Settings

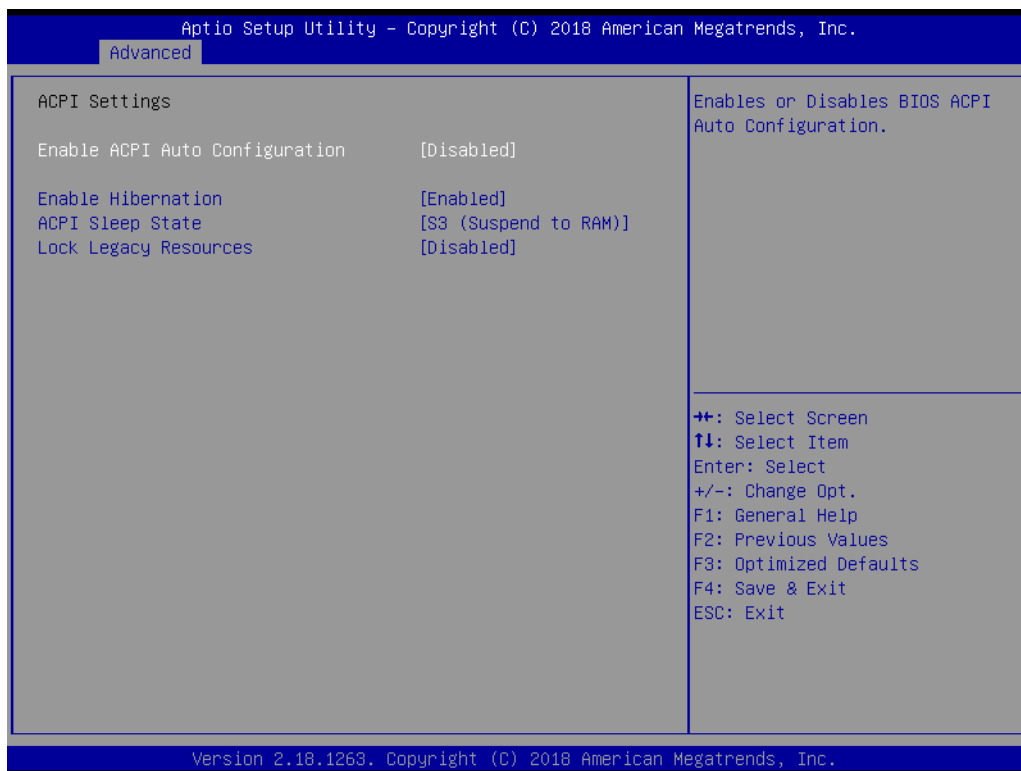

- **Enable ACPI Auto Configuration**
Enable or disable BIOS ACPI auto configuration.
- **Enable Hibernation**
Enables or Disables System ability to Hibernate (OS/S4 Sleep State). This option may be not effective with some OS.
- **ACPI Sleep State**
Select the highest ACPI sleep state the system will enter when the SUSPEND button is pressed.
- **Lock Legacy Resources**
Enables or Disables Lock of Legacy Resources

3.1.2.4 iManager Configuration

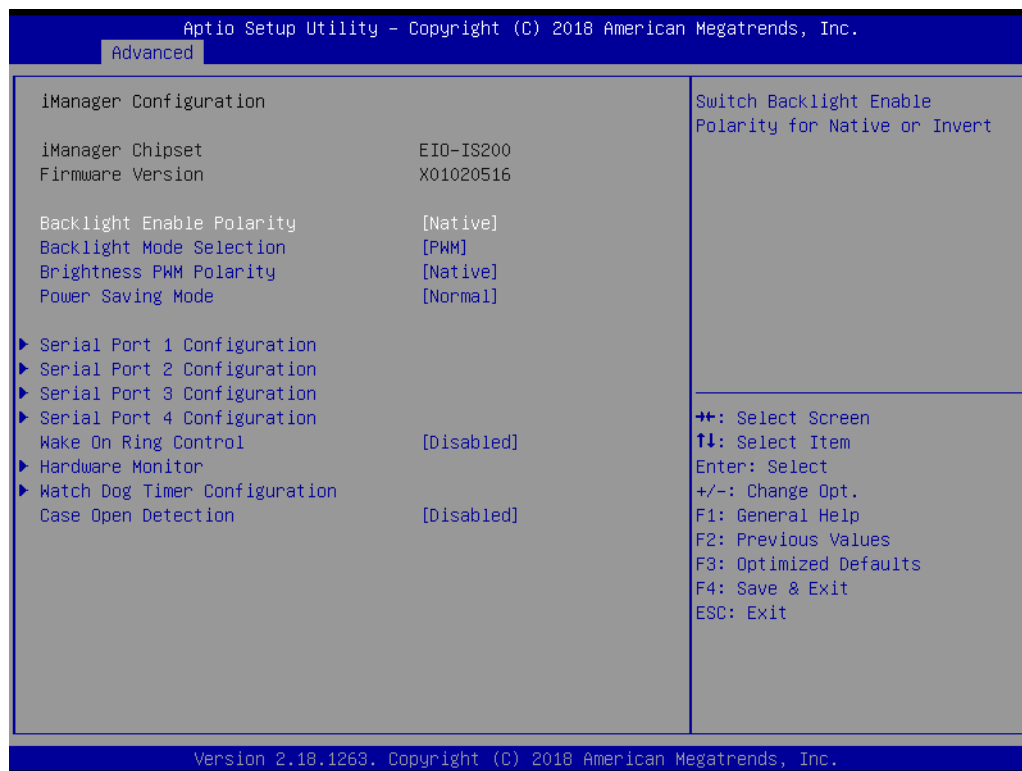

- **Backlight Enable Polarity**
Switch Backlight Enable Polarity for Native or Invert.
- **Backlight Mode Selection**
Switch Backlight Control to PWM or DC modet.
- **Brightness PWM Polarity**
Switch Backlight Control Brightness PWM Polarity for Native or Invert.
- **Power Saving Mode**
This item allows users to set board's power saving mode when off.
- **Serial Port 1 Configuration**
Set Parameters of Serial Port 1 (COMA).
- **Serial Port 2 Configuration**
Set Parameters of Serial Port 2 (COMB).
- **Serial Port 3 Configuration**
Set Parameters of Serial Port 3 (COMC).
- **Serial Port 4 Configuration**
Set Parameters of Serial Port 4 (COMD).
- **Wake On Ring Control**
Enable/Disable Wake On Ring Function.
- **Hardware Monitor**
Monitor hardware statue.
- **Watch Dog Timer Configuration**
Watch Dog Timer Configuration Page.
- **Case Open Detection**
Enabled or Disabled Case Open Detect Funton.

HW Monitor

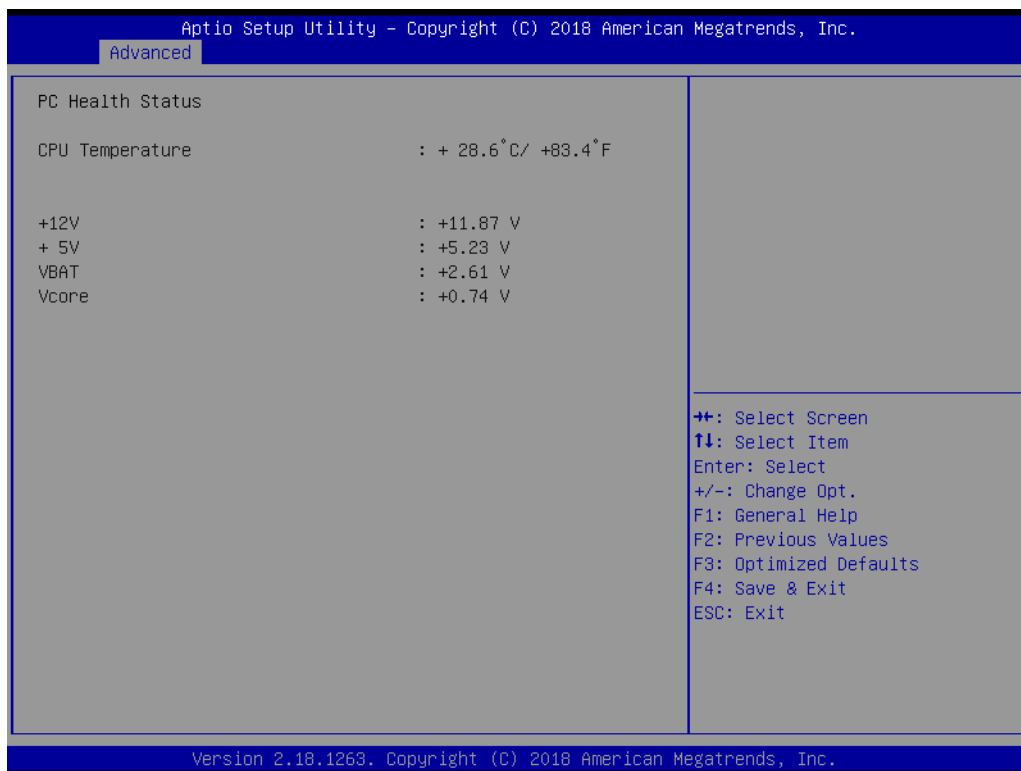

- **PC Health Status**
This page displays all information about system Temperature/Voltage.

Watch Dog Timer Configuration



- **Watch Dog Timer**

This page displays all information about Watch Dog Timer Configuration.

3.1.2.5 S5 RTC Wake Settings

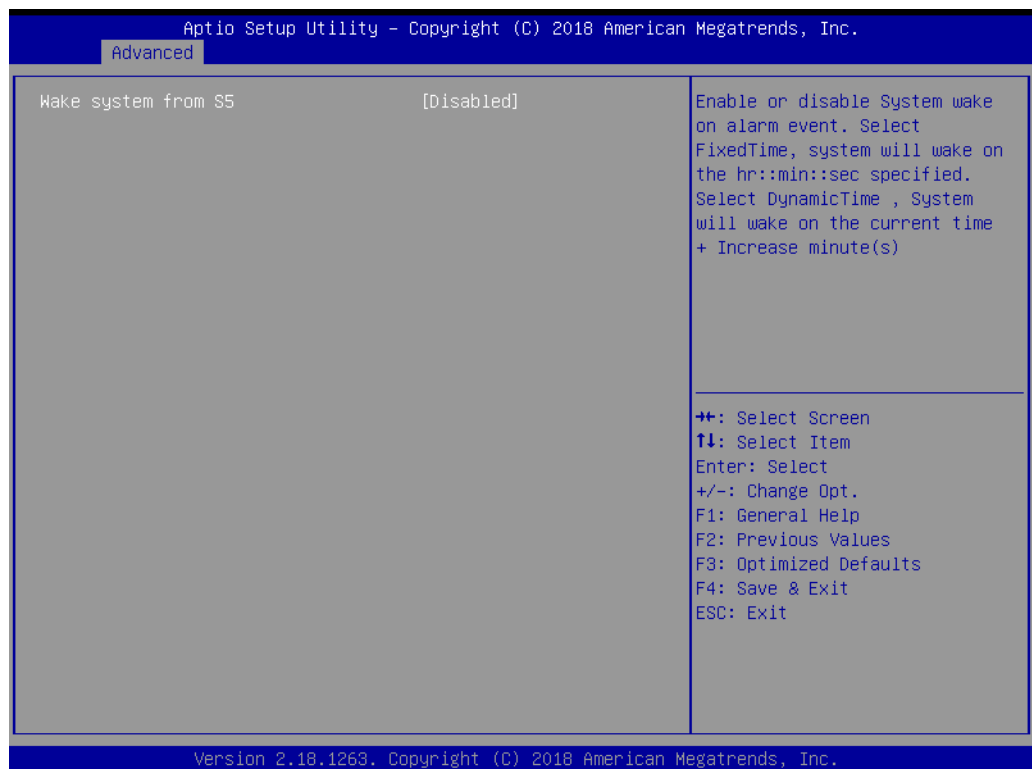

- **Wake system from S5**

Enable or disable System wake on alarm event. Select FixedTime, system will

wake on the hr::min::sec specified.

3.1.2.6 Serial Port Console Redirection

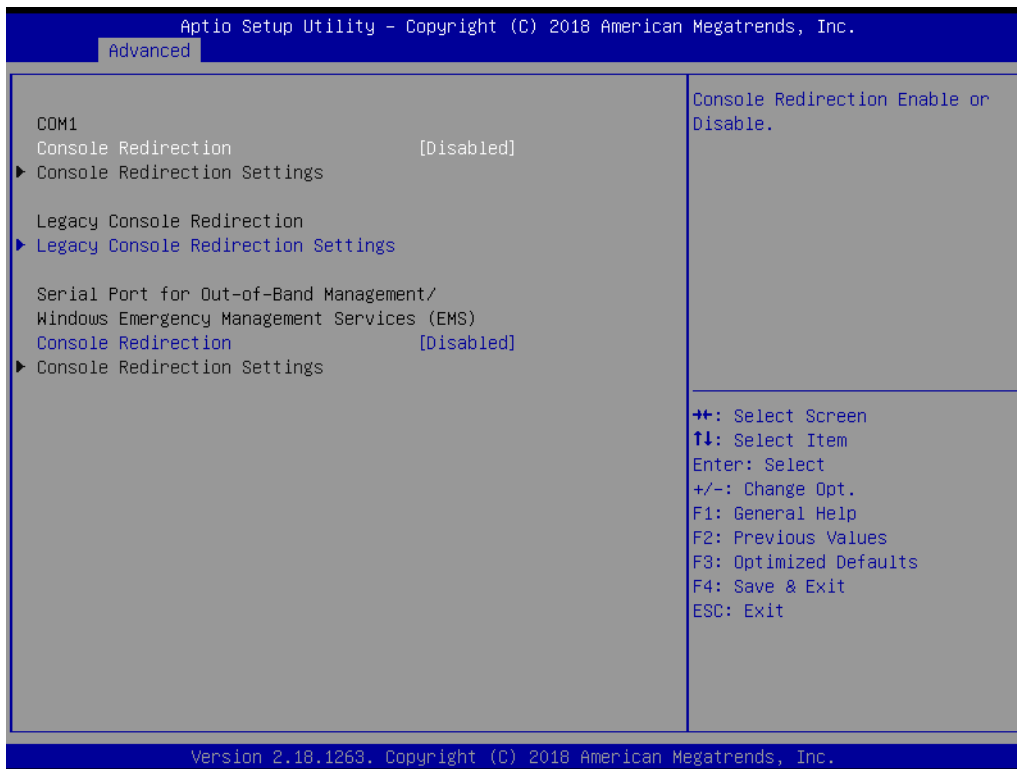

- **Console Redirection**
This item allows users to enable or disable console redirection for Microsoft Windows Emergency Management Services (EMS).
- **Console Redirection**
This item allows users to configuration console redirection detail settings.

3.1.2.7 CPU Configuration

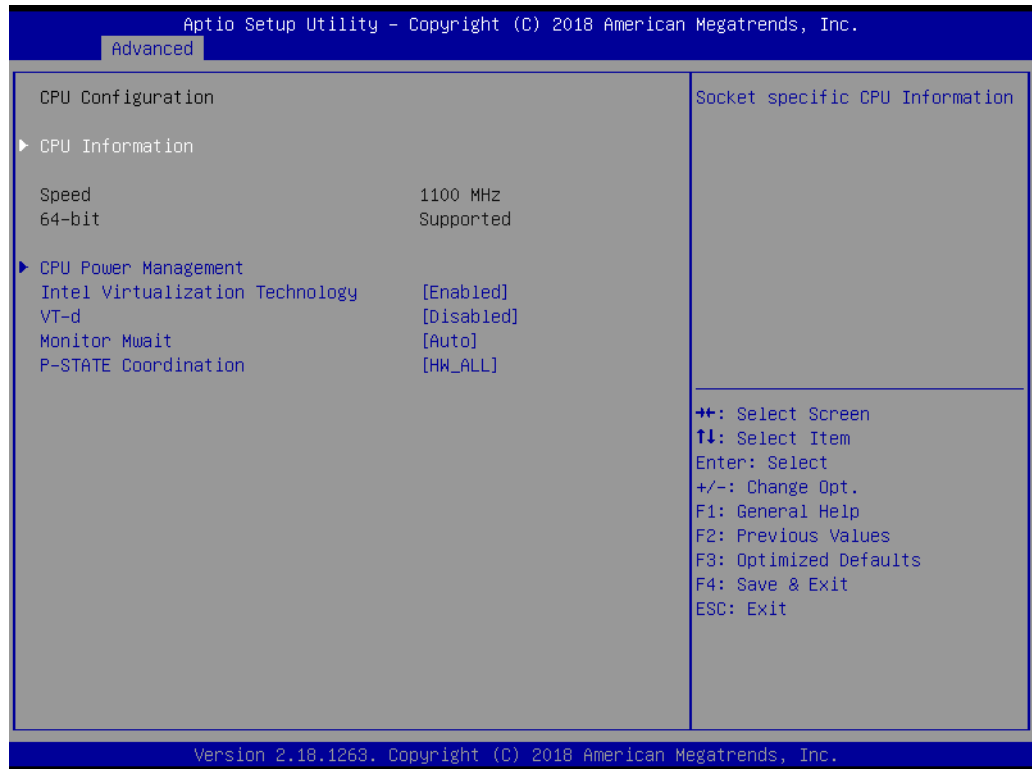

- **Intel Virtualization Technology**
When enabled, a VMM can utilize the additional hardware capabilities provided by Vanderpool Technology.
- **VT-d**
Enable/Disable CPU VT-d.
- **Monitor Mwait**
Enable/Disable Monitor Mwait.
- **P-STATE Coordination**
Change P-STATE Coordination type.

3.1.2.8 Network Stack Configuration

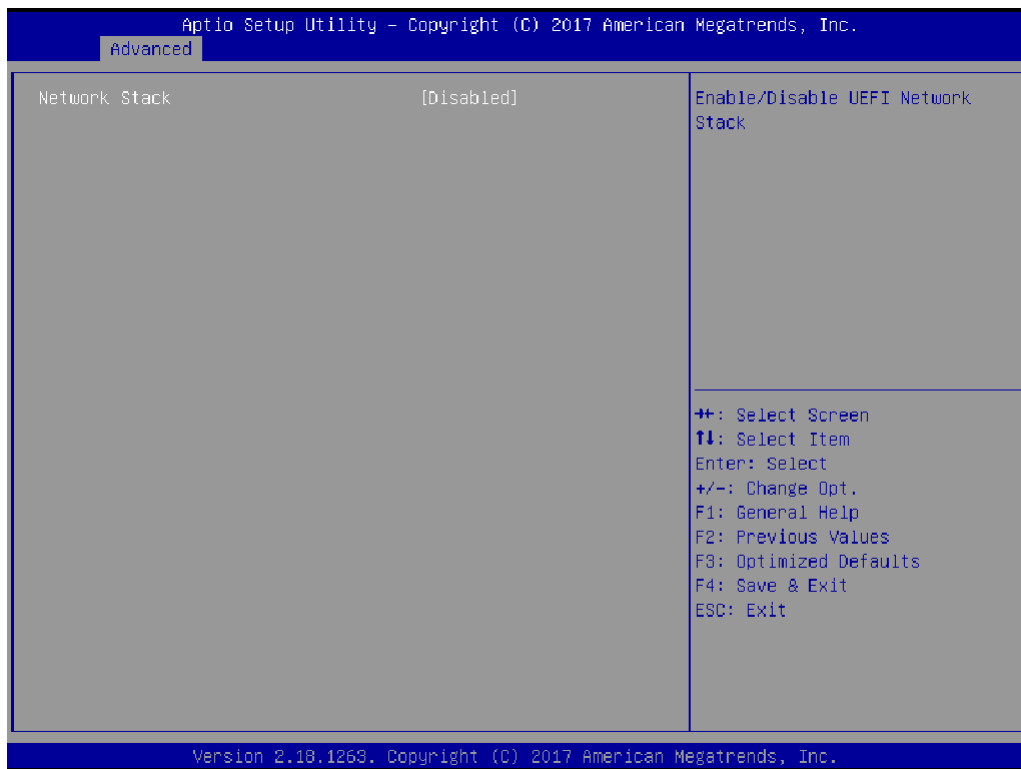

- **Network Stack**
Enable/Disable UEFI Network Stack.

3.1.2.9 CSM Configuration



CSM Support for debug purpose

- **CSM Support**
Enable/Disable CSM Support.
- **GateA20 Active**
UPON REQUEST - GA20 can be disabled using BIOS services. ALWAYS - do not allow disabling GA20; this option is useful when any RT code is executed above 1MB.
- **INT19 Trap Response**
BIOS reaction on INT19 trapping by Option ROM: IMMEDIATE - execute the trap right away; POSTPONED - execute the trap during legacy boot.
- **Boot option filter**
This option controls Legacy/UEFI ROMs priority.
- **Network**
Controls the execution of UEFI and Legacy PXE OpROM.
- **Storage**
Controls the execution of UEFI and Legacy Storage OpROM.
- **Video**
Controls the execution of UEFI and Legacy Video OpROM.
- **Other PCI devices**
Determines OpROM execution policy for devices other than Network, Storage, or Video.

3.1.2.10 USB Configuration

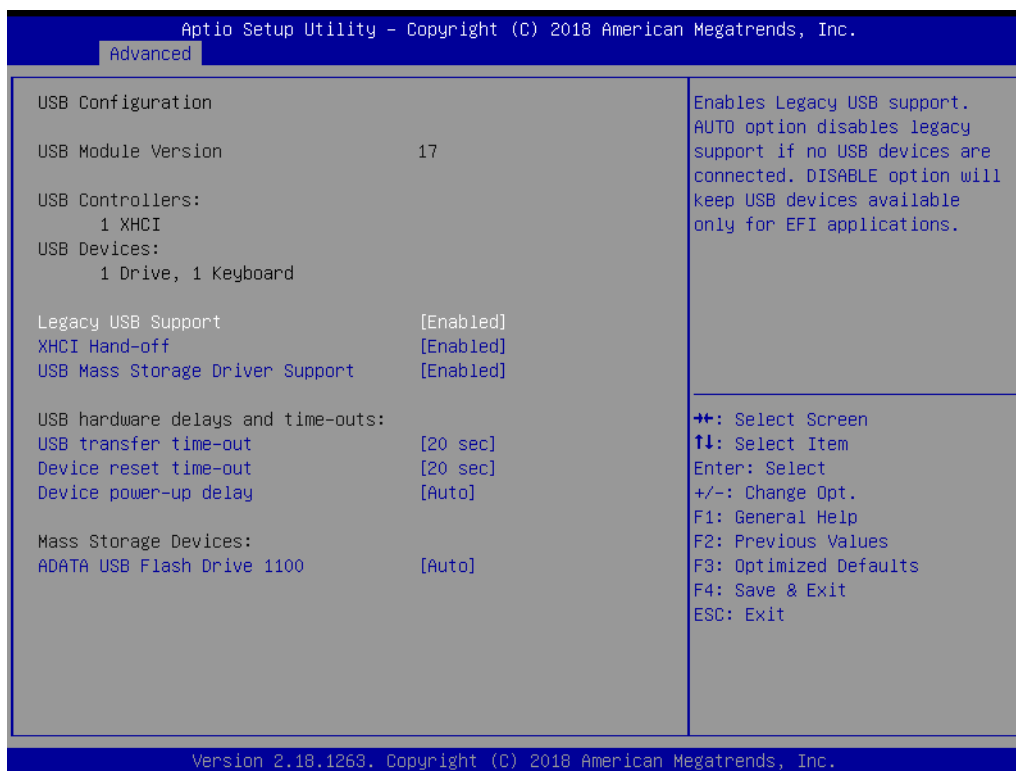

- **Legacy USB Support**
Enables Legacy USB support. AUTO option disables legacy support if no USB devices are connected. DISABLE option will keep USB devices available only for EFI applications.
- **XHCI Hand-off**
This is a workaround for OSES without XHCI hand-off support. The XHCI ownership change should be claimed by XHCI driver.
- **USB Mass Storage Driver Support**
Enable/Disable USB Mass Storage Driver Support.
- **USB transfer time-out**
Time-out value for control, Bulk, and interrupt transfers.
- **Device reset time-out**
USB mass storage device start unit command time-out.
- **Device power-up delay**
Maximum time the device will take before it properly reports itself to the Host Controller. 'Auto' uses default value: for a Root port it is 100 ms, for a Hub port the delay is taken from Hub descriptor.

3.1.2.11 Security Configuration

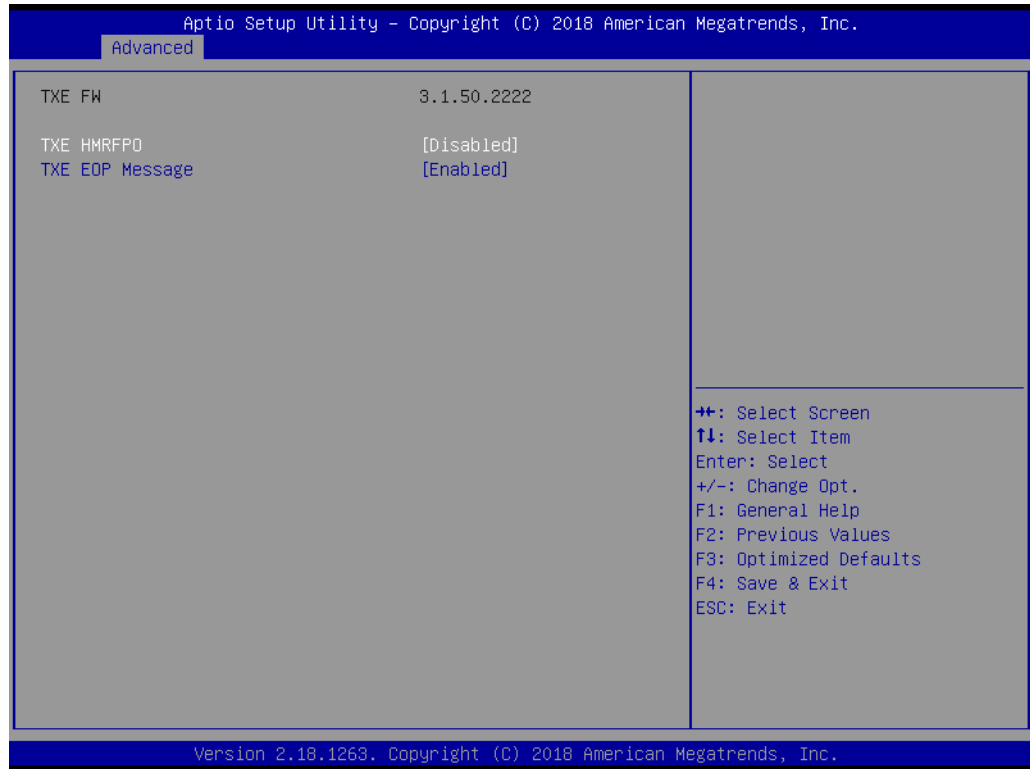

- **TXE HMRFPD Disable**
- **TXE EOP Message**
Send EOP Message Before Enter OS

3.1.3 Chipset Configuration

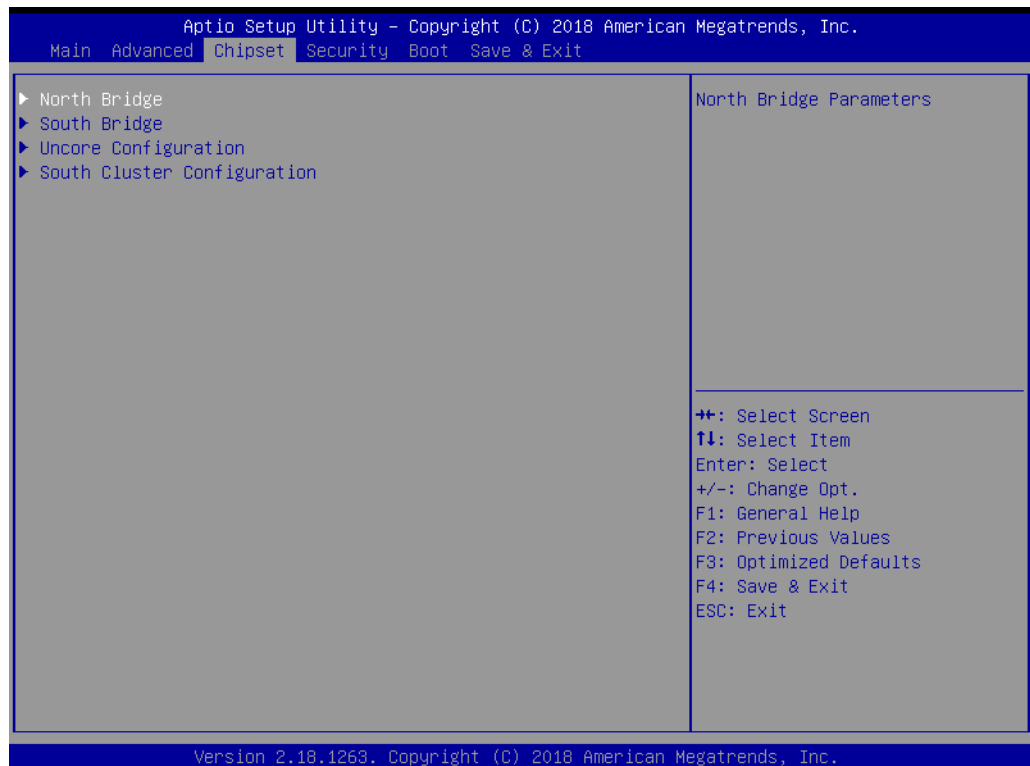

- **North Bridge**
Details for North Bridge items.
- **South Bridge**
Details for South Bridge items.
- **Uncore Configuration**
Details for Uncore Configuration.
- **South Cluster Configuration**
Details for South Cluster Configuration.

3.1.3.1 North Bridge

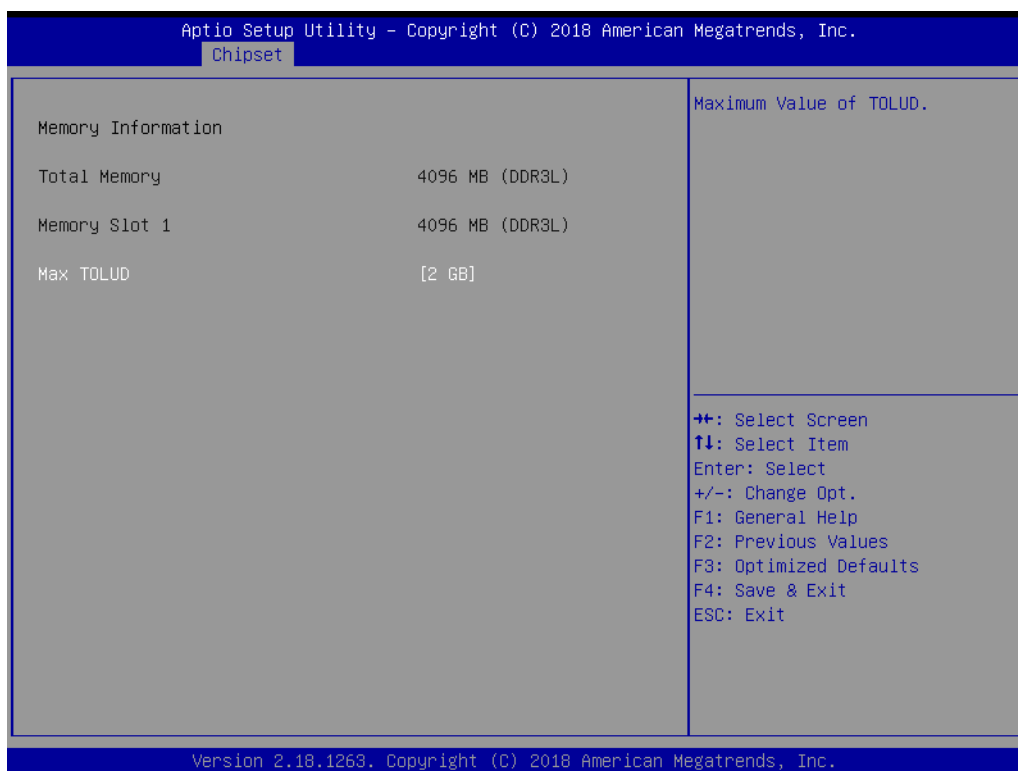

- **Max TOLUD**
Maximum Value of TOLUD.

3.1.3.2 South Bridge

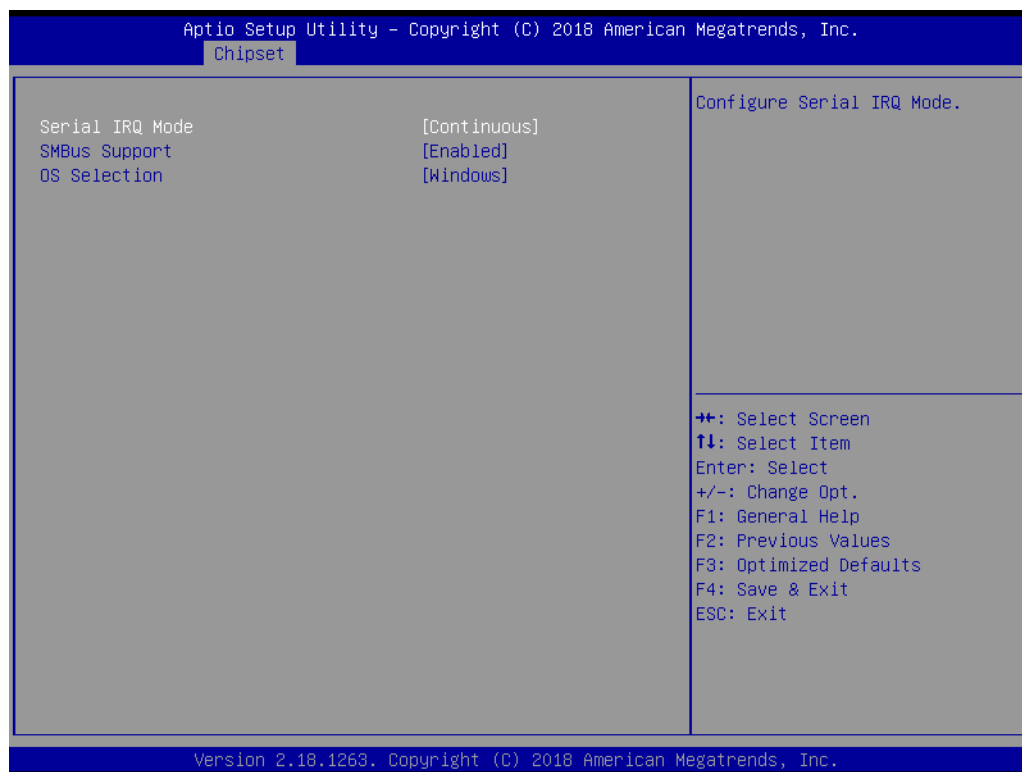

- **Serial IRQ Mode**
Configure Serial IRQ Mode.
- **SMBus Support**
Enable/Disable SMBus Support.
- **OS Selection**
Select the target OS.

3.1.3.3 Uncore Configuration

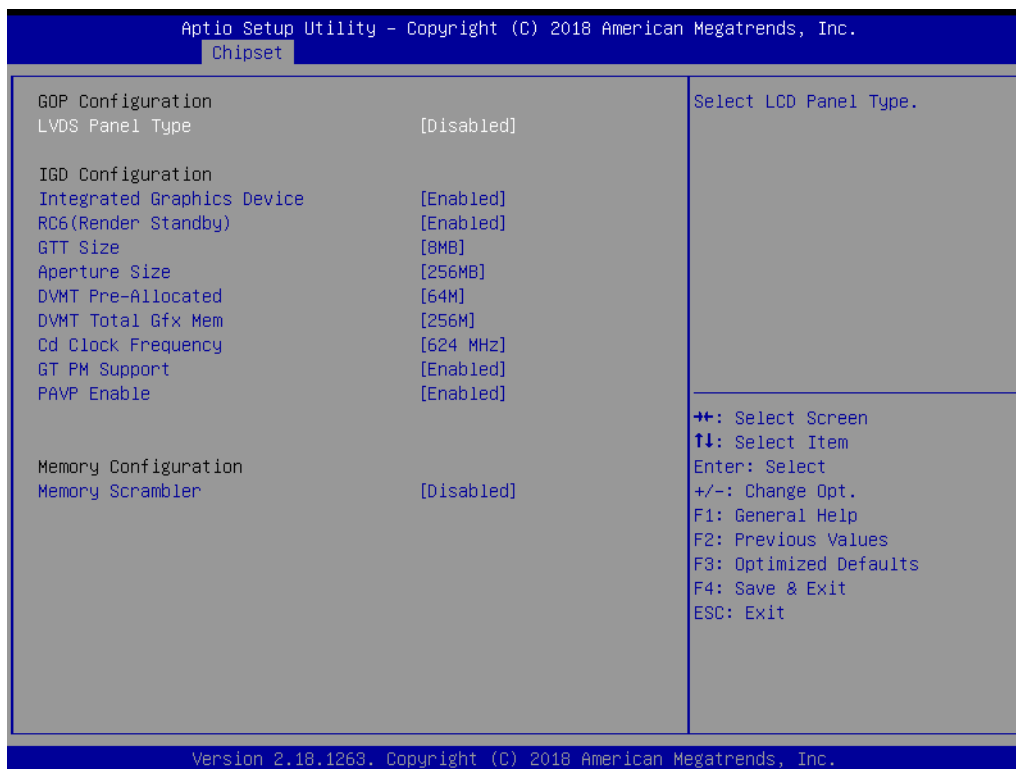

- **LVDS Panel Type**
Select LCD Panel Type.
- **Integrated Graphics Device**
Enable : Enable Integrated Graphics Device (IGD) when selected as the Primary Video Adaptor. Disable : Always disable IGD.
- **RC6 Render Standby**
Check to enable render standby support.
- **GTT Size**
Select the GTT Size
- **Aperture Size**
Select the Aperture Size.
- **DVMT Pre-Allocated**
Select DVMT 5.0 Pre-Allocated (Fixed) Graphics Memory size used by the Internal Graphics Device.
- **DVMT Total Gfx Mem**
Select DVMT 5.0 Total Graphic Memory size used by the Internal Graphics Device.
- **Cd Clock Frequency**
Select the highest Cd Clock frequency supported by the platform.
- **GT PM Support**
Enable/Disable GT PM Support.
- **PAVP Enable**
Enable/Disable PAVP.
- **Memory Scrambler**
Enable/Disable Memory Scrambler support.

3.1.3.4 South Cluster Configuration

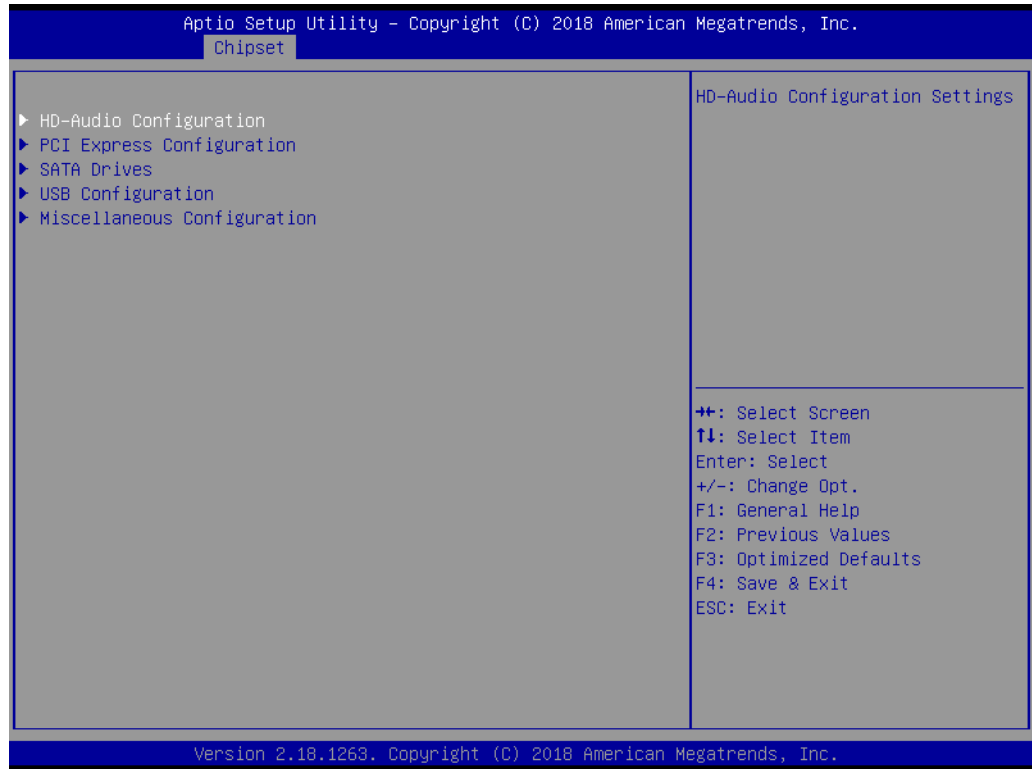

- **HD-Audio Configuration**
HD-Audio Configuration Settings.
- **PCI Express Configuration**
PCI Express Configuration Settings.
- **SATA Drives**
Press <Enter> to select the SATA Device Configuration Setup options.
- **USB Configuration**
USB Configuration Settings.
- **Miscellaneous Configuration**
Enable/Disable Misc. Features.

HD-Audio Configuration

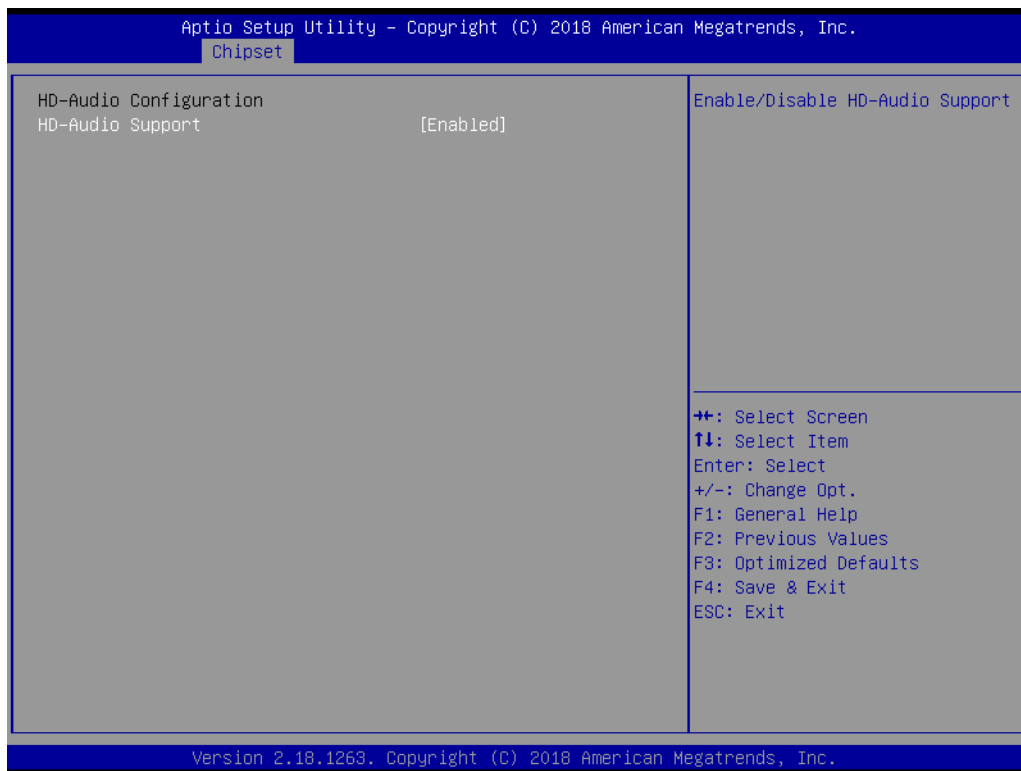

- **HD-Audio Support**
Enable/Disable HD-Audio Support.

PCI Express Configuration

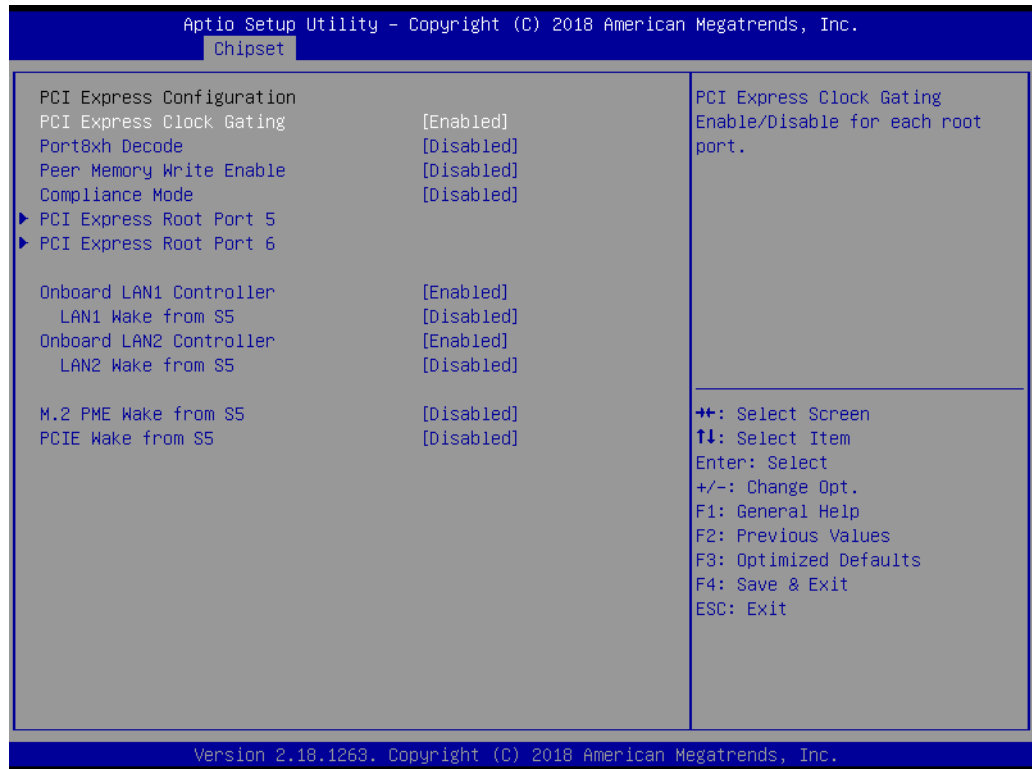

- **Compliance Mode**
Compliance Mode Enable/Disable.
- **PCI Express Root Port 5 / 6**
Control the PCI Express Root Port.
- **Onboard LAN1/2 Controller**
Select to Enable or Disable Onboard LAN1/2 Controller.
- **LAN Option ROM**
Enabled / Disabled Onboard LAN's PXE option ROM.
- **M.2 PME Wake from S5**
Enable or disable M.2 PME to wake the system from S5.
- **PCIE Wake from S5**
Enable or disable PCIE to wake the system from S5.

SATA Drives

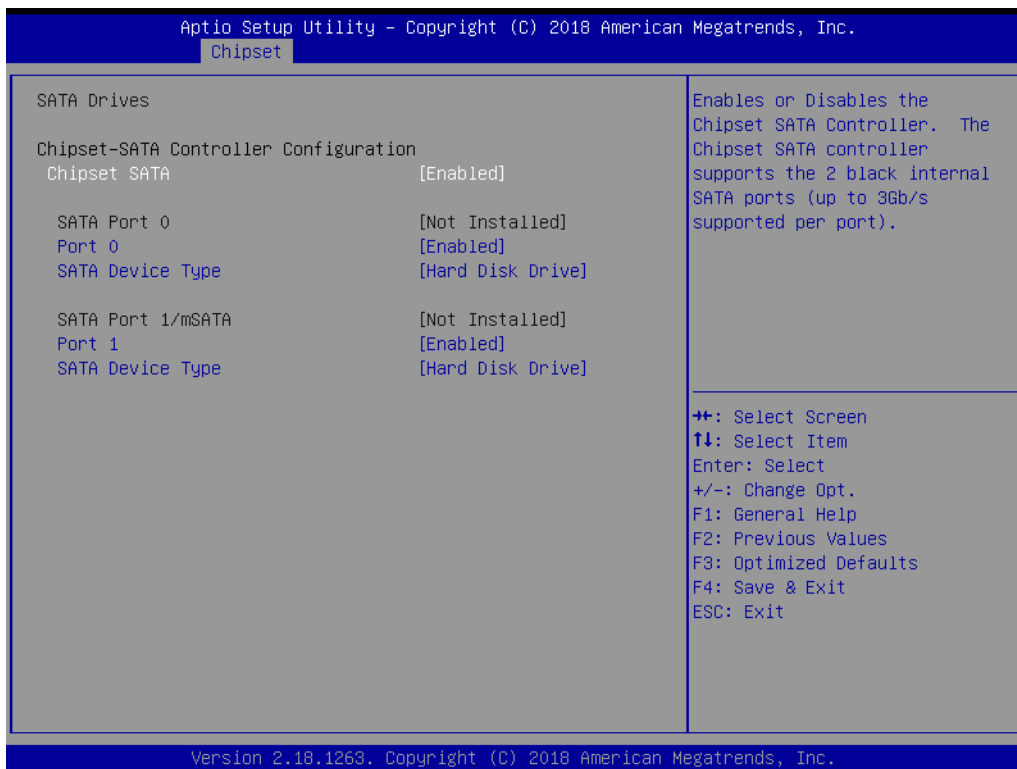

- **Chipset SATA**
Enable or Disable the Chipset SATA Controller.

USB Configuration

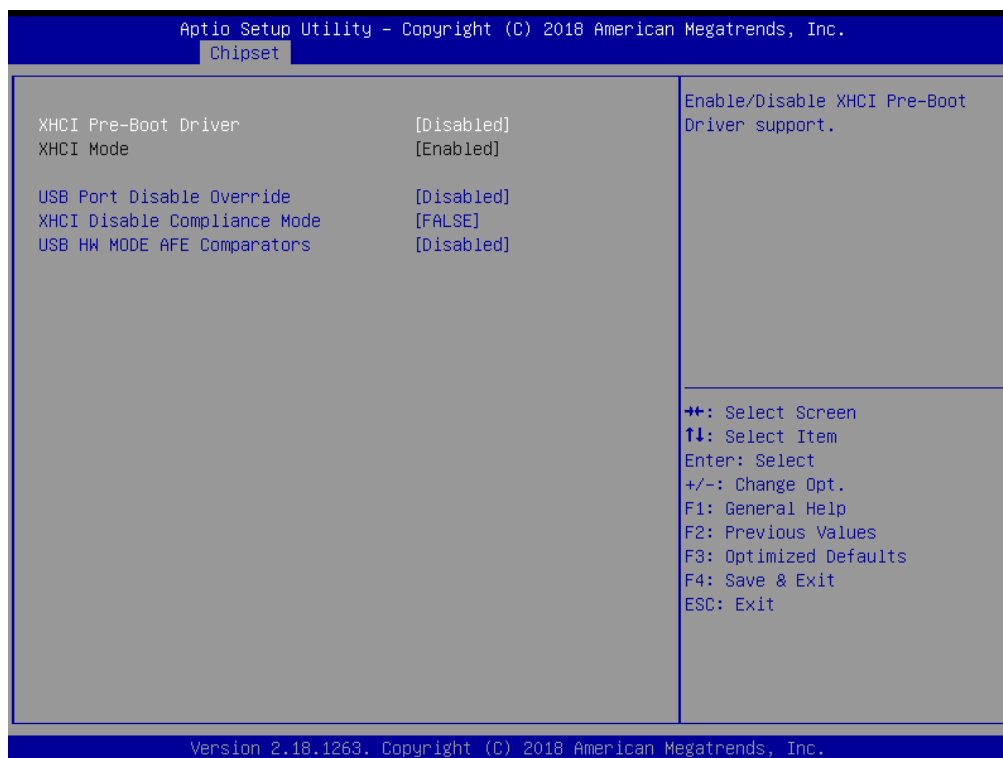

- **XHCI Pre-Boot Driver**
Enable/Disable XHCI Pre-Boot Driver Support.
- **USB Port Disable Override**
Selectively Enable/Disable corresponding USB port from reporting a Device Connection to the controller.
- **XHCI Disable Compliance Mode**
Options to disable XHCI Link Compliance Mode.
- **USB HW MODE AFE Comparators**
Enable/Disable USB HW MODE AFE Comparators.

Miscellaneous Configuration

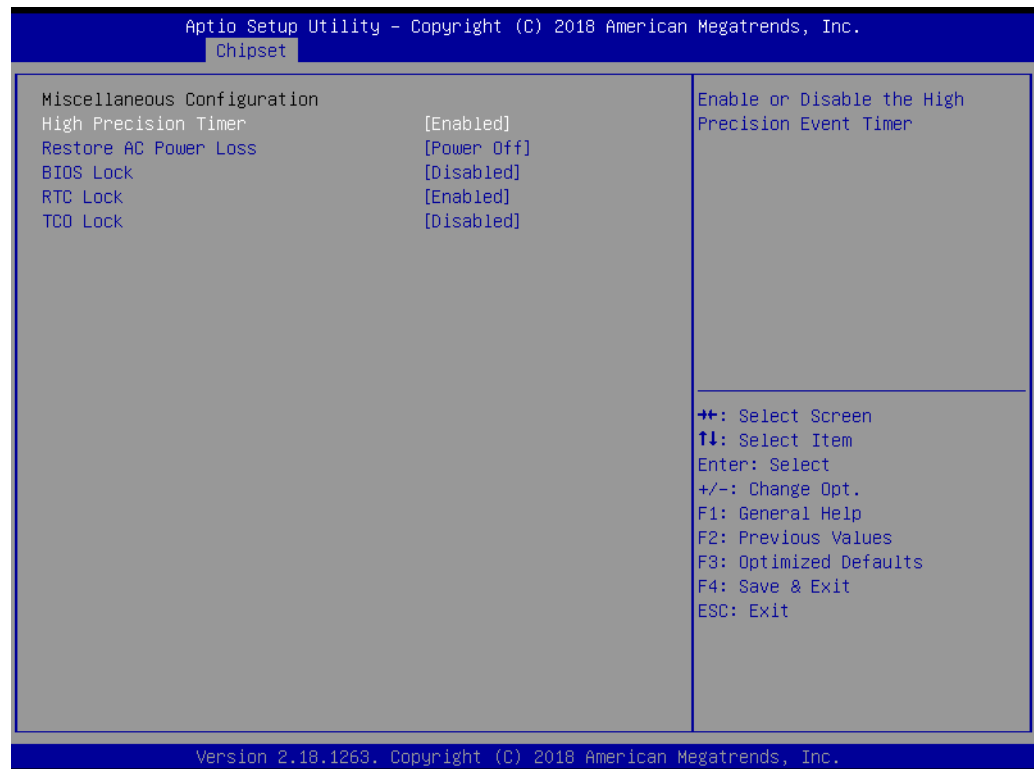

- **High Precision Timer**
Enable or Disable the High Precision Timer.
- **Restore AC Power Loss**
Specify what state to go to when power is re-applied after a power failure (G3 state).
- **BIOS Lock**
Enable/Disable the BIOS Lock Enable feature.
- **RTC Lock**
Enable or disable bytes 38h-3Fh in the upper and lower 128-byte bank of RTC RAM lockdown.
- **TCO SMI Lock**
Enable TCO and Lock Down TCO.

3.1.4 Security

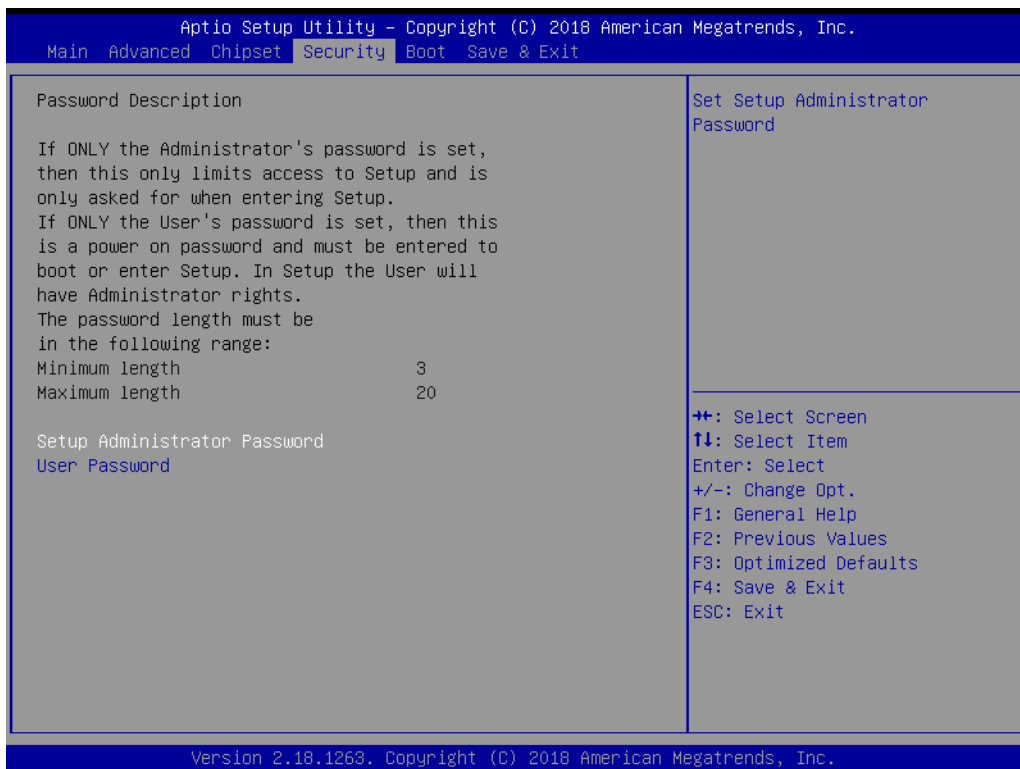

Select Security Setup from the PCM-9366 Setup main BIOS setup menu. All Security Setup options, such as password protection and virus protection are described in this section. To access the sub menu for the following items, select the item and press <Enter>:

- **Change Administrator / User Password**
Select this option and press <ENTER> to access the sub menu, and then type in the password.

3.1.5 Boot

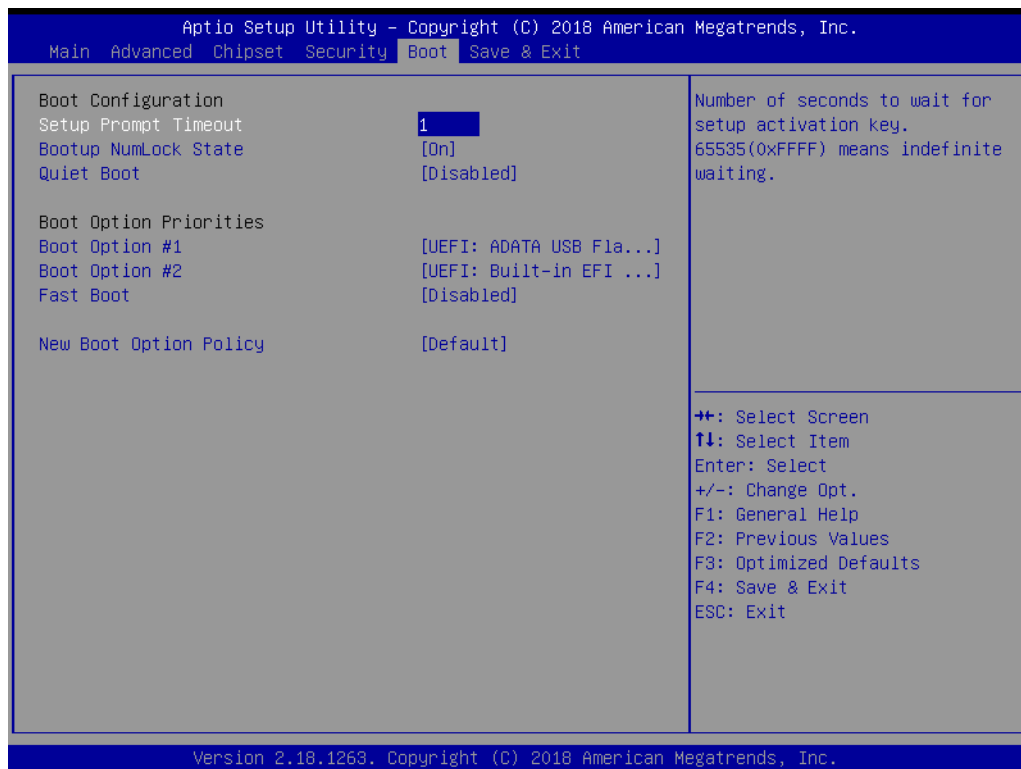

- **Setup Prompt Timeout**
Number of seconds that the firmware will wait before initiating the original default boot selection. A value of 0 indicates that the default boot selection is to be initiated immediately on boot. A value of 65535(0xFFFF) indicates that firmware will wait for user input before booting. This means the default boot selection is not automatically started by the firmware.
- **Bootup NumLock State**
Select the keyboard NumLock state.
- **Quiet Boot**
Enables or disables Quiet Boot option.
- **Boot Option #1**
Sets the system boot order.
- **Fast Boot**
Enables or disables boot with initialization of a minimal set of devices required to launch active boot option. Has no effect for BBS boot options.
- **New Boot Option Policy**
Controls the placement of newly detected UEFI boot options.

3.1.6 Save & Exit

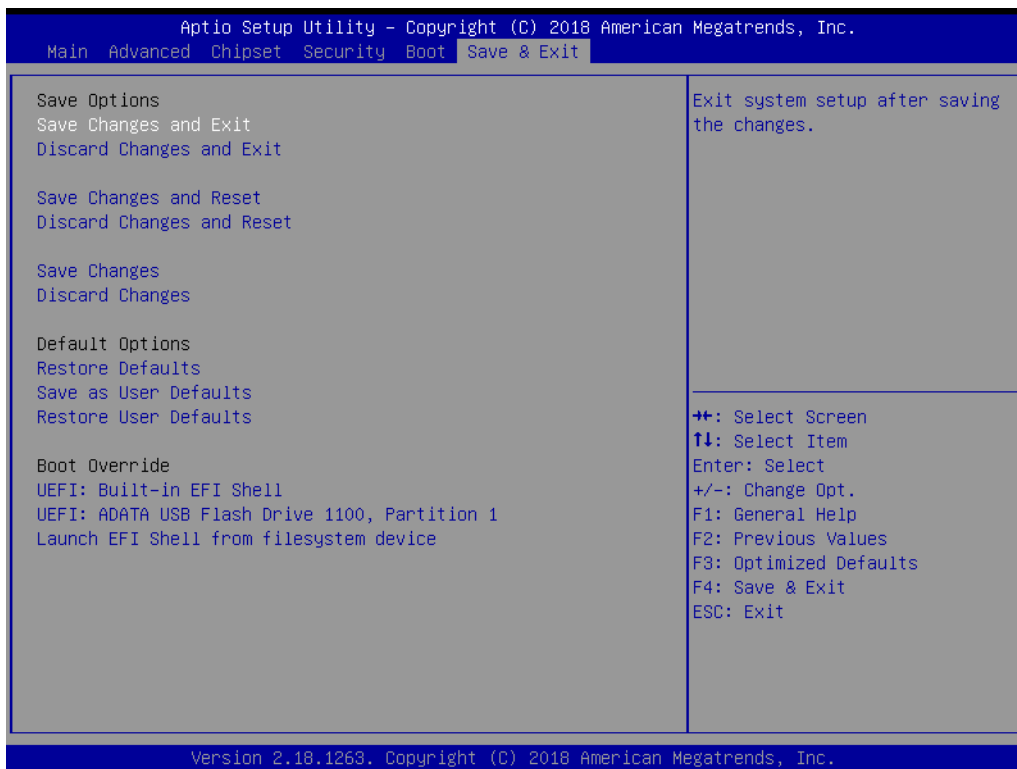

- **Save Changes and Exit**
This item allows you to exit system setup after saving the changes.
- **Discard Changes and Exit**
This item allows you to exit system setup without saving any changes.
- **Save Changes and Reset**
This item allows you to reset the system after saving the changes.
- **Discard Changes and Reset**
This item allows you to rest system setup without saving any changes.
- **Save Changes**
This item allows you to save changes done so far to any of the options.
- **Discard Changes**
This item allows you to discard changes done so far to any of the options.
- **Restore Defaults**
This item allows you to restore/load default values for all the options.
- **Save as User Defaults**
This item allows you to save the changes done so far as user defaults.
- **Restore User Defaults**
This item allows you to restore the user defaults to all the options.
- **Boot Override**
Boot device select can override your boot priority.

Appendix **A**

Pin Assignments

This appendix contains information of a detailed or specialized nature.

Sections include:

- Jumper and Connector Tables

A.1 Jumper List

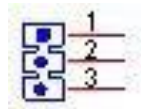

J1	Clear CMOS
Part Number	1653003101
Footprint	HD_3x1P_79_D
Description	PIN HEADER 3x1P 2.0mm 180D(M) DIP 2000-13 WS
Pin	Pin Name
1	RTCRST#
2	GND
3	RTCTSET#
(1-2)*	Normal (default)
(2-3)*	Clear CMOS

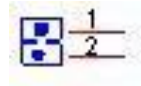

J2	CASE OPEN
Part Number	1653002101-02
Footprint	HD_2x1P_79_D
Description	
Pin	Pin Name
1	RDC_CASEOPEN
2	GND

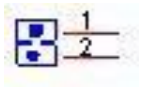

J3	Auto Power On Setting
Part Number	1653002101-02
Footprint	HD_2x1P_79_D
Description	
Setting	Function
NC	Power Button for Power On
(1-2)*	Auto Power On

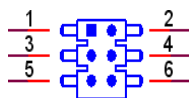

J4	LCD Power
Part Number	1653003260
Footprint	HD_3x2P_79
Description	PIN HEADER 3x2P 2.0mm 180D(M) SMD 21N22050
Setting	Function
(1-3)*	+3.3V
(3-5)	+5V
(3-4)	+12V

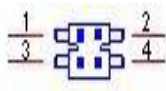

J5	LVDS VCON Setting
Part Number	1653000014
Footprint	HD_2x2P_79
Description	PIN HEADER 2x2P 2.00mm 180D(M) SMD 21N22050
Setting	Function
(1-2)*	3.3V High for VCON on LVDS
(2-3)	Low for VCON on LVDS

A.2 Connector Pin Definition

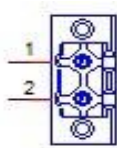

CN1	Power Input
Part Number	1652002724
Footprint	ME060-50002
Description	
Pin	Pin Name
1	GND
2	+VIN

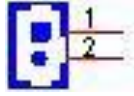

CN3	Battery
Part Number	1655005427-01
Footprint	WF_2P_49_53398-0271
Description	
Pin	Pin Name
1	GND
2	+3V

CN4	SODIMMDDR3_204
Part Number	1651002088
Footprint	SODIMMDDR3_204P_AS0A626-HA
Description	DDR3 SODIMM H=9.2mm 204P SMD AS0A626-HASN-7H
Pin	Pin Name

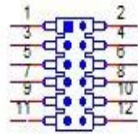

CN5	IS200 Debug Port
Part Number	1653007040-01
Footprint	HD_6X2P_50_21N21040-12M00B
Description	
Pin	Pin Name
1	GND
2	TMS
3	GND
4	TDI
5	GND
6	TDO
7	GND
8	TCK
9	GND
10	GND
11	GND
12	CLK

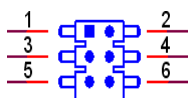

CN6	CAN1/CAN2
Part Number	1653003260
Footprint	HD_3x2P_79
Description	PIN HEADER 3x2P 2.0mm 180D(M) SMD 21N22050
Pin	Pin Name
1	GND
2	GND
3	D1+
4	D2+
5	D1-
6	D2-

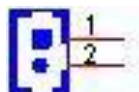

CN8	Power Switch
Part Number	1655302020
Footprint	WF_2P_79_BOX_R1_D
Description	WAFER BOX 2P 2.0mm 180D(M) DIP A2001WV2-2P
Pin	Pin Name
1	PSIN
2	GND

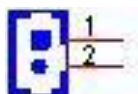

CN9	Reset
Part Number	1655302020
Footprint	WF_2P_79_BOX_R1_D
Description	WAFER BOX 2P 2.0mm 180D(M) DIP A2001WV2-2P
Pin	Pin Name
1	RESET#
2	GND

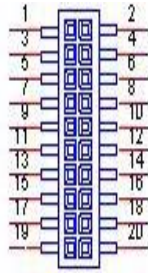

CN10	COM3/COM4/RS422/RS485
Part Number	1653004793
Footprint	HD_10x2P_79_23N685B-20M10
Description	BOX HEADER 10x2P 2.0mm 180D(M)SMD 23N685B-20M10B
Pin	Pin Name
1	422TX3-/485D3-/DCD3#
2	DSR3#
3	422TX3+/485D3+/RXD3
4	RTS3#
5	422RX3+/TXD3
6	CTS3#
7	422RX3-/DTR3#
8	RI3#
9	GND
10	GND
11	422TX4-/485D4-/DCD4#
12	DSR4#
13	422TX4+/485D4+/RXD4
14	RTS4#
15	422RX4+/TXD4
16	CTS4#
17	422RX4-/DTR4#
18	RI4#
19	GND
20	GND

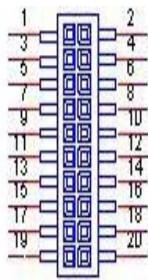

CN11	COM1/COM2
Part Number	1653004793
Footprint	HD_10x2P_79_23N685B-20M10
Description	BOX HEADER 10x2P 2.0mm 180D(M)SMD 23N685B-20M10B
Pin	Pin Name
1	DCD1#
2	DSR1#
3	RXD1
4	RTS1#
5	TXD1
6	CTS1#
7	DTR1#
8	RI1#
9	GND
10	GND
11	DCD2#
12	DSR2#
13	RXD2
14	RTS2#
15	TXD2
16	CTS2#
17	DTR2#
18	RI2#
19	GND
20	GND

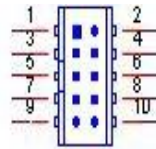

CN12	Audio
Part Number	1653004099
Footprint	HD_5x2P_79_23N685B-10M10
Description	BOX HEADER 5x2P 2.00mm 180D(M) SMD 23N685B-10M10
Pin	Pin Name
1	LOUTR
2	LINR
3	GND
4	GND
5	LOUTL
6	LINL
7	GND
8	GND
9	MIC1R
10	MIC1L

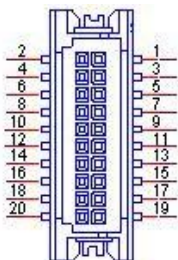

CN13		eDP	
Part Number	1653006914-01		
Footprint	df13-20dp-125v		
Description			
Pin	Pin Name		
1	GND		
2	GND		
3	D0-		
4	D3-		
5	D0+		
6	D3+		
7	GND		
8	NC		
9	D1-		
10	NC		
11	D1+		
12	AUX-		
13	GND		
14	AUX+		
15	D2-		
16	GND		
17	D2+		
18	Hot Plug Detect		
19	+5V or +3.3V		
20	+5V or +3.3V		

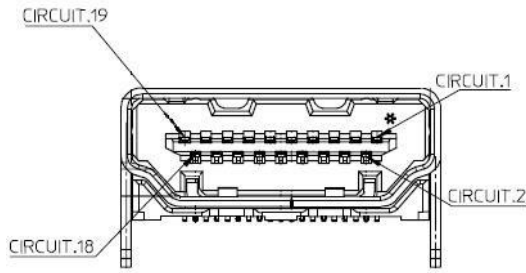

CN14	HDMI
Part Number	1654012807-01
Footprint	HDMI_19P_QJ5119K-HFB4-7F
Description	
Pin	Pin Name
1	TMDS Data2+
2	TMDS Data2 Shield
3	TMDS Data2-
4	TMDS Data1+
5	TMDS Data1 Shield
6	TMDS Data1-
7	TMDS Data0+
8	TMDS Data0 Shield
9	TMDS Data0-
10	TMDS Clock+
11	TMDS Clock Shield
12	TMDS Clock-
13	Reserved
14	Reserved
15	SCL
16	SDA
17	DDC Ground
18	+5V Power
19	Hot Plug Detect

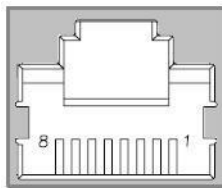

CN16	LAN
Part Number	1652003274
Footprint	RJ45_28P_RTB-19GB9J1A
Description	PHONE JACK RJ45 28P DIP RTB-19GB9J1A
Pin	Pin Name
1	TX+(10/100),BI_DA+(GHz)
2	TX-(10/100),BI_DA-(GHz)
3	RX+(10/100),BI_DB+(GHz)
4	BI_DC+(GHz)
5	BI_DC-(GHz)
6	RX-(10/100),BI_DB-(GHz)
7	BI_DD+(GHz)
8	BI_DD-(GHz)

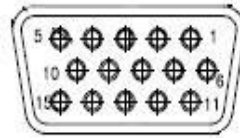

CN18	VGA
Part Number	1654011261-01
Footprint	DBVGA-VF5MS
Description	
Pin	Pin Name
1	RED
2	GREEN
3	BLUE
4	NC
5	GND
6	GND
7	GND
8	GND
9	+5V
10	GND
11	NC
12	DDAT
13	HSYNC
14	VSYNC
15	DCLK

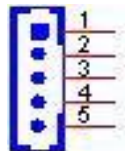

CN19	Inverter Power Output
Part Number	1655000453
Footprint	WHL5V-2M-24W1140
Description	WAFER BOX 2.0mm 5P 180D(M) DIP WO/Pb JIH VEI
Pin	Pin Name
1	+12V
2	GND
3	ENABKL
4	VBR
5	+5V

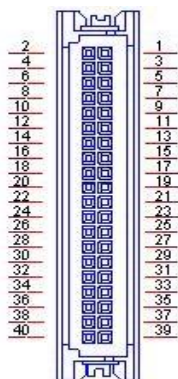

CN20	48-bit LVDS Panel
Part Number	1653006918-01
Footprint	SPH20X2
Description	
Pin	Pin Name
1	+5V or +3.3V
2	+5V or +3.3V
3	GND
4	GND
5	+5V or +3.3V
6	+5V or +3.3V
7	LVDS0_D0-
8	LVDS1_D0-
9	LVDS0_D0+
10	LVDS1_D0+
11	GND
12	GND
13	LVDS0_D1-
14	LVDS1_D1-
15	LVDS0_D1+
16	LVDS1_D1+
17	GND
18	GND
19	LVDS0_D2-
20	LVDS1_D2-
21	LVDS0_D2+
22	LVDS1_D2+
23	GND
24	GND
25	LVDS0_CLK-
26	LVDS1_CLK-

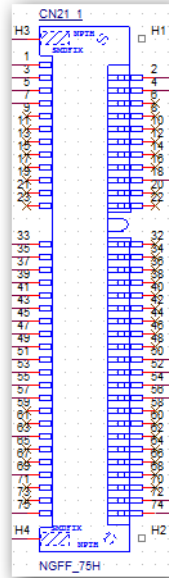

CN21	NGFF CONN
Part Number	1654012663-01
Footprint	NGFF_75P_APCI0163-P001A
Description	
Pin	Pin Name
1	GND
2	+V3.3SB_M.2
3	USB4_P+
4	+V3.3SB_M.2
5	USB4_P-
6	N/A
7	N/A
8	N/A
9	N/A
10	N/A
11	N/A
12	N/A
13	N/A
14	N/A
15	N/A
16	N/A
17	N/A
18	GND
19	N/A
20	N/A -
21	N/A
22	N/A
23	N/A
24	N/A
25	N/A

CN21	NGFF CONN
26	N/A
27	N/A
28	N/A
29	N/A
30	N/A
31	N/A
32	N/A
33	GND
34	N/A
35	PCIE_M2_Z_TX2+
36	N/A
37	PCIE_M2_Z_TX2-
38	N/A
39	GND
40	N/A
41	PCIE_M2_RX2+
42	N/A
43	PCIE_M2_RX2-
44	N/A
45	GND
46	N/A
47	CLK_M2_Z_PCIE+
48	N/A
49	CLK_M2_Z_PCIE-
50	PMU_SUSCLK
51	GND
52	M2_PLTRST#
53	PCIE_A_CLKREQ2#
54	BT_DISABLE#
55	M2_PCIE_WAKE2#
56	WIFI_DISABLE#
57	GND
58	N/A
59	N/A
60	N/A
61	N/A
62	N/A
63	GND
64	N/A
65	N/A
66	N/A
67	N/A
68	N/A
69	GND
70	N/A
71	N/A
72	+V3.3SB_M.2

CN21	NGFF CONN
73	N/A
74	+V3.3SB_M.2
75	GND

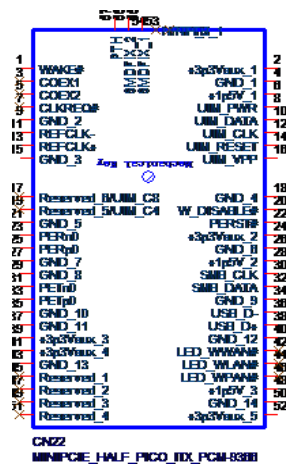

CN22	MINIPCIE_HALF_PICO_ITX_PCM-9366
Part Number	00A00001940
Footprint	MINIPCIE_HALF_PICO_ITX_PCM-9366
Description	
Pin	Pin Name
1	PCIE_MINI_A_WAKE3#
2	+V3.3_MINICARD1
3	NA
4	GND
5	NA
6	+V1.5
7	NA
8	+VUIM_PWR
9	GND
10	UIM_DATA
11	CLK_MINI1_Z_PCIE-
12	UIM_CLK
13	CLK_MINI1_Z_PCIE+
14	UIM_RESET
15	GND
16	+VUIM_VPP
17	NC
18	GND
19	NC
20	WIFI1_Z_DISABLE#
21	GND
22	PM_PLTRST#
23	MSATA_MPCIE_RX-
24	+V3.3_MINICARD1

CN22	MINIPCIE_HALF_PICO_ITX_PCM-9366
25	MSATA_MPCIE_RX+
26	GND
27	GND
28	+V1.5
29	GND
30	SOC_SMB_CLK
31	MSATA_MPCIE_TX-
32	SOC_SMB_DAT
33	MSATA_MPCIE_TX+
34	GND
35	GND
36	USB5_P-
37	GND
38	USB5_P+
39	+V3.3_MINICARD1
40	GND
41	+3p3Vaux_4
42	N/A
43	mSATAH_mPCIE#_a_SEL
44	N/A
45	N/A
46	N/A
47	N/A
48	+V1.5
49	N/A
50	GND
51	N/A
52	+V3.3_MINICARD1

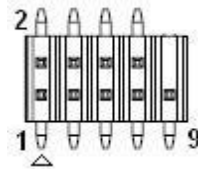

CN23	Internal USB
Part Number	1653005260
Footprint	HD_5x2P_79_N10
Description	PIN HEADER 2x5P 2.0mm 180D(M) SMD 21N22050
Pin	Pin Name
1	+5V
2	+5V
3	A_D-
4	B_D-
5	A_D+
6	B_D+
7	GND
8	GND
9	GND

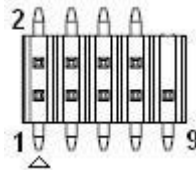

CN24	Internal USB
Part Number	1653005260
Footprint	HD_5x2P_79_N10
Description	PIN HEADER 2x5P 2.0mm 180D(M) SMD 21N22050
Pin	Pin Name
1	+5V
2	+5V
3	A_D-
4	B_D-
5	A_D+
6	B_D+
7	GND
8	GND
9	GND



CN25	External USB3.0
Part Number	1654011725-01
Footprint	USB_9x2P_WDU3R-18F3B4PBUW3
Description	
Pin	Pin Name
1	+5V
2	D-
3	D+
4	GND
5	SSRX-
6	SSRX+
7	GND
8	SSTX-
9	SSTX+
10	+5V
11	D-
12	D+
13	GND
14	B_SSRX-
15	B_SSRX+
16	GND
17	B_SSTX-
18	B_SSTX+

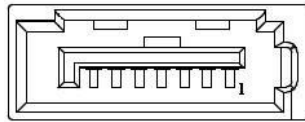

CN26	SATA
Part Number	1654011616-01
Footprint	SATA_7P_WATF-07DBN6SB1U
Description	Serial ATA 7P 1.27mm 180D(M) SMDWATF-07DBLSB1UW
Pin	Pin Name
1	GND
2	TX+
3	TX-
4	GND
5	RX-
6	RX+
7	GND

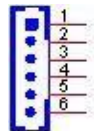

CN27	HDD & PWR LED
Part Number	1655306020-01
Footprint	WF_6P_79_BOX_D_721-81-06TW00
Description	
Pin	Pin Name
1	+5V
2	GND
3	Power LED+(5V)
4	GND
5	Power LED+(3V)
6	SATA LED

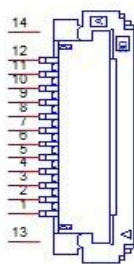

CN28	LPC Debug Port
Part Number	1654011013-01
Footprint	FPC_12P_20_04-6239
Description	
Pin	Pin Name
1	NC
2	NC
3	NC
4	GND
5	+3.3V
6	RESET#
7	CLK
8	AD0
9	AD1
10	AD2
11	AD3
12	FRAME#

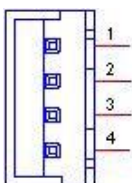

CN29	SATA Power
Part Number	1655001154
Footprint	WF_4P_98_BOX_R1_D
Description	WAFER BOX 4P 2.50mm 180D(M) DIP 24W1170-04S10-01
Pin	Pin Name
1	+5V
2	GND
3	GND
4	+12V

\

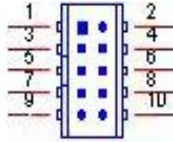

CN30	GPIO
Part Number	1653004099
Footprint	HD_5x2P_79_23N685B-10M10
Description	BOX HEADER 5x2P 2.00mm 180D(M) SMD 23N685B-10M10
Pin	Pin Name
1	+5V
2	GPIO12
3	GPIO8
4	GPIO13
5	GPIO9
6	GPIO14
7	GPIO10
8	GPIO15
9	GPIO11
10	GND

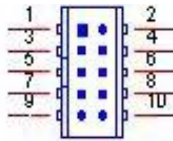

CN31	GPIO
Part Number	1653004099
Footprint	HD_5x2P_79_23N685B-10M10
Description	BOX HEADER 5x2P 2.00mm 180D(M) SMD 23N685B-10M10
Pin	Pin Name
1	+5V
2	GPIO4
3	GPIO0
4	GPIO5
5	GPIO1
6	GPIO6
7	GPIO2
8	GPIO7
9	GPIO3
10	GND

GPIO spec.			
GPIO Pin	Output/Input	Low/High	Open Drain/Push Pull
0	Input	Low	Open Drain
1	Input	Low	Open Drain
2	Input	Low	Open Drain
3	Input	Low	Open Drain
4	Input	Low	Open Drain
5	Input	Low	Open Drain
6	Input	Low	Open Drain
7	Input	Low	Open Drain
8	Input	Low	Open Drain
9	Input	Low	Open Drain
10	Input	Low	Open Drain
11	Input	Low	Open Drain
12	Input	Low	Open Drain
13	Input	Low	Open Drain
14	Input	Low	Open Drain
15	Input	Low	Open Drain

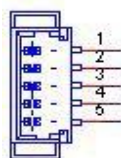

CN32	SMBus
Part Number	1655004032
Footprint	WF_5P_49_BOX_85205
Description	WAFER 5P 1.25mm 180D(M) SMD 85205-05701
Pin	Pin Name
1	GND
2	SMB_ALERT#
3	SMB_DAT
4	SMB_CLK
5	+5V

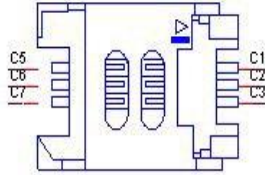

CN33	SIM
Part Number	1654010809-01
Footprint	SIM_6P_5210622-SINR03
Description	SIM card conn. 6p 2.54mm 90D(F) SMD 5210622-SINR
Pin	Pin Name
C1	UIM_PWR
C2	UIM_RESET
C3	UIM_CLK
C5	GND
C6	UIM_VPP
C7	UIM_DATA



SW1	DIP SW
Part Number	1600003260-01
Footprint	SW_2x2P_100_198x378
Description	DIP SW ESD102LT61Z SMD 2x2P 5.08X6.6mm
Pin	Pin Name
1	mSATAH_mPCIE#_SEL
2	mSATAH_mPCIE#_SEL
3	GND
4	mSATAH_mPCIE#_a_SEL

Appendix **B**

System Assignments

This appendix contains information of a detailed nature.

Sections include:

- System I/O Ports
- 1st MB Memory Map
- Interrupt Assignments

B.1 System I/O Ports

Table B.1: System I/O Ports

Addr. Range (Hex)	Device
20–2D	Interrupt Controller
2E – 2F	Motherboard resources
30 – 3D	Interrupt Controller
40 – 43	System timer
4E – 4F	Motherboard resources
50 – 53	System timer
61 – 67	Motherboard resources
70 - 77	System CMOS/real time clock
80 - 92	Motherboard resources
A0 – B1	Interrupt Controller
B2 – B3	Motherboard resources
B4 – BD	Interrupt Controller
272 – 273	Motherboard resources
290 – 29F	Embedded Controller resources
2E8 – 2EF	COM4
2F8 – 2FF	COM2
3B0 – 3DF	Intel® HD Graphics
3E8 – 3EF	COM3
3F8 – 3FF	COM1
400 – 47F	Motherboard resources
4D0 – 4D1	Interrupt Controller
500 – 57F	Motherboard resources

B.2 1st MB Memory Map

Table B.2: 1st MB Memory Map

Addr. Range (Hex)	Device
A0000h - BFFFFh	Intel® HD Graphics
A0000h - BFFFFh	PCI Bus
C0000h - DFFFFh	PCI Bus
E0000h - FFFFFh	PCI Bus
D0400000 – D05FFFFFF	Intel® Trusted Execution Engine Interface
E0000000 - FEFFFFFF	System resources

B.3 Interrupt Assignments

Table B.3: Interrupt assignments

Interrupt#	Interrupt source
NMI	Parity error detected
IRQ0	System timer
IRQ1	Using SERIRQ, Keyboard Emulation
IRQ2	Slave controller INTR output
IRQ3	Communications Port (COM2)
IRQ4	Communications Port (COM1)
IRQ5	Available
IRQ6	Available
IRQ7	Communications Port (COM3) / iManager WatchDog IRQ
IRQ8	Internal RTC or HPET
IRQ9	Microsoft ACPI-Compliant System
IRQ10	Available
IRQ11	Communications Port (COM4)
IRQ12	Available
IRQ13	Numeric data processor
IRQ14	SATA controller
IRQ15	SATA controller

ADVANTECH

Enabling an Intelligent Planet

www.advantech.com

Please verify specifications before quoting. This guide is intended for reference purposes only.

All product specifications are subject to change without notice.

No part of this publication may be reproduced in any form or by any means, electronic, photocopying, recording or otherwise, without prior written permission of the publisher.

All brand and product names are trademarks or registered trademarks of their respective companies.

© Advantech Co., Ltd. 2018

Appendix **D**

EC Watchdog Timer
Sample Code

D.1 EC Watchdog Timer sample code

EC_Command_Port = 0x29Ah

EC_Data_Port = 0x299h

Write EC HW ram = 0x89

Watch dog event flag = 0x57

Watchdog reset delay time = 0x5E

Reset event = 0x04

Start WDT function = 0x28

=====

.model small

.486p

.stack 256

.data

.code

org 100h

.STARTup

mov dx, EC_Command_Port

mov al,89h ;Write EC HW ram.

out dx,al

mov dx, EC_Data_Port

mov al, 5Fh ;Watchdog reset delay time low byte (5Eh is high byte) index.

out dx,al

mov dx, EC_Data_Port

mov al, 30h ;Set 3 seconds delay time.

out dx,al

mov dx, EC_Command_Port

mov al,89h ;Write EC HW ram.

out dx,al

mov dx, EC_Data_Port

mov al, 57h ;Watch dog event flag.

out dx,al

mov dx, EC_Data_Port

mov al, 04h ;Reset event.

out dx,al

mov dx, EC_Command_Port

mov al,28h ;Start WDT function.

out dx,al

.exit

END

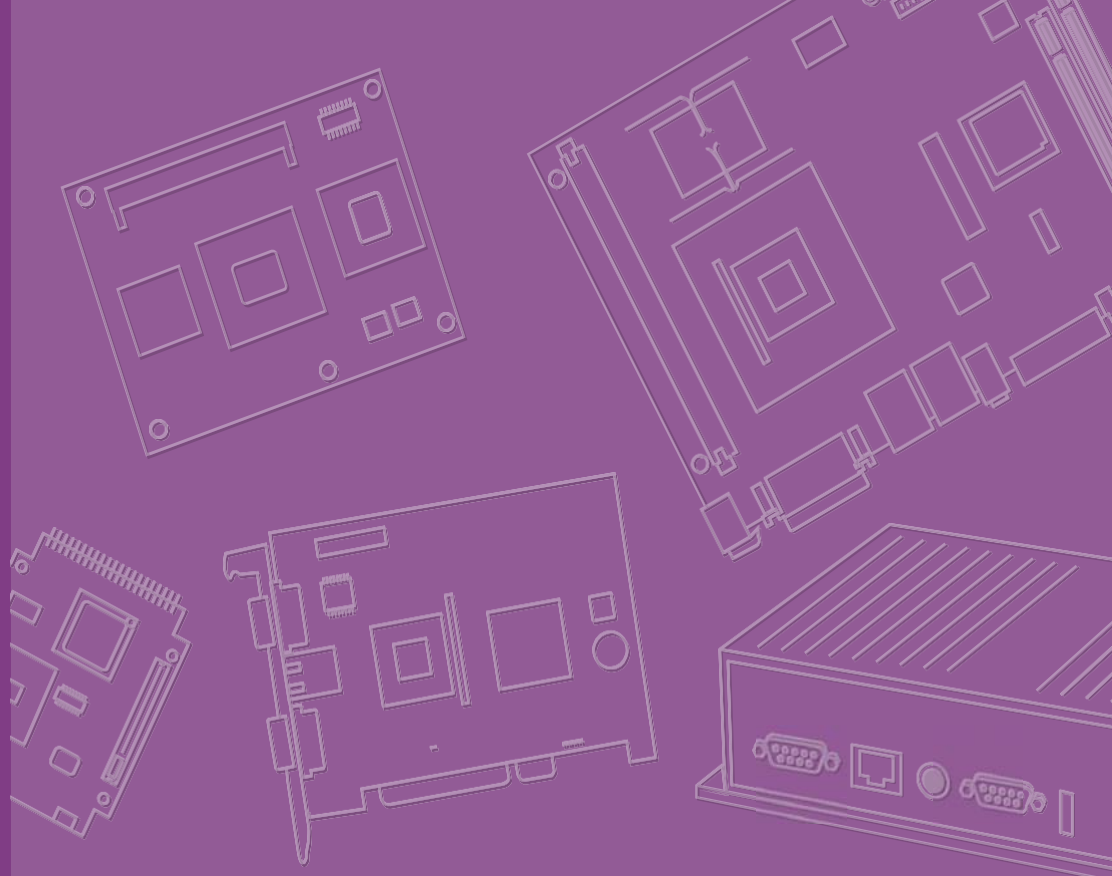

PCM-9366

Intel® Pentium N4200 Celeron N3350 & Atom™ E3950/E3940/E3930, DDR3L, HDMI, VGA, 48-bit LVDS/*eDP, 2GbE, M.2 Key E, Mini PCIe/mSATA, M.2 Key E, wide range power input, iManager

Copyright

The documentation and the software included with this product are copyrighted 2015 by Advantech Co., Ltd. All rights are reserved. Advantech Co., Ltd. reserves the right to make improvements in the products described in this manual at any time without notice. No part of this manual may be reproduced, copied, translated or transmitted in any form or by any means without the prior written permission of Advantech Co., Ltd. Information provided in this manual is intended to be accurate and reliable. However, Advantech Co., Ltd. assumes no responsibility for its use, nor for any infringements of the rights of third parties, which may result from its use.

Acknowledgements

Intel® is a trademark of Intel® Corporation.

AMI is a trademark of American Megatrends, Inc.

IBM, PC, PS/2 and VGA are trademarks of International Business Machines Corporation.

Microsoft Windows®, DirectX® is a registered trademark of Microsoft Corp.

All other product names or trademarks are properties of their respective owners.

For more information on this and other Advantech products, please visit our websites at:

<http://www.advantech.com>

<http://www.advantech.com/eplatform>

For technical support and service, please visit our support website at:

<http://support.advantech.com/>

This manual is for the PCM-9366.

Product Warranty (2 years)

Advantech warrants to you, the original purchaser, that each of its products will be free from defects in materials and workmanship for two years from the date of purchase.

This warranty does not apply to any products which have been repaired or altered by persons other than repair personnel authorized by Advantech, or which have been subject to misuse, abuse, accident or improper installation. Advantech assumes no liability under the terms of this warranty as a consequence of such events.

Because of Advantech's high quality-control standards and rigorous testing, most of our customers never need to use our repair service. If an Advantech product is defective, it will be repaired or replaced at no charge during the warranty period. For out-of-warranty repairs, you will be billed according to the cost of replacement materials, service time and freight. Please consult your dealer for more details.

If you think you have a defective product, follow these steps:

1. Collect all the information about the problem encountered. (For example, CPU speed, Advantech products used, other hardware and software used, etc.) Note anything abnormal and list any onscreen messages you get when the problem occurs.
2. Call your dealer and describe the problem. Please have your manual, product, and any helpful information readily available.
3. If your product is diagnosed as defective, obtain an RMA (return merchandise authorization) number from your dealer. This allows us to process your return more quickly.
4. Carefully pack the defective product, a fully-completed Repair and Replacement Order Card and a photocopy proof of purchase date (such as your sales receipt) in a shippable container. A product returned without proof of the purchase date is not eligible for warranty service.
5. Write the RMA number visibly on the outside of the package and ship it prepaid to your dealer.

Declaration of Conformity

CE

This product has passed the CE test for environmental specifications. Test conditions for passing included the equipment being operated within an industrial enclosure. In order to protect the product from being damaged by ESD (Electrostatic Discharge) and EMI leakage, we strongly recommend the use of CE-compliant industrial enclosure products.

FCC Class B

This equipment has been tested and found to comply with the limits for a Class B digital device, pursuant to part 15 of the FCC Rules. These limits are designed to provide reasonable protection against harmful interference when the equipment is operated in a commercial environment. This equipment generates, uses, and can radiate radio frequency energy and, if not installed and used in accordance with the instruction manual, may cause harmful interference to radio communications. Operation of this equipment in a residential area is likely to cause harmful interference in which case the user will be required to correct the interference at his own expense.

Caution! *There is a danger of a new battery exploding if it is incorrectly installed. Do not attempt to recharge, force open, or heat the battery. Replace the battery only with the same or equivalent type recommended by the manufacturer. Discard used batteries according to the manufacturer's instructions.*



Battery Information

Batteries, battery packs, and accumulators should not be disposed of as unsorted household waste.

Please use the public collection system to return, recycle, or treat them in compliance with the local regulations.



Technical Support and Assistance

1. Visit the Advantech website at <http://support.advantech.com> where you can find the latest information about the product.
2. Contact your distributor, sales representative, or Advantech's customer service center for technical support if you need additional assistance. Please have the following information ready before you call:
 - Product name and serial number
 - Description of your peripheral attachments
 - Description of your software (operating system, version, application software, etc.)
 - A complete description of the problem
 - The exact wording of any error messages

Packing List

Before you begin installing your card, please make sure that the following materials have been shipped:

- 1 x PCM-9366 SBC
- 1 x SATA Cable 32cm (p/n: 1700008941)
- 1 x SATA Power Cable 35cm (p/n: 1700018785)
- 1 x Audio Cable 20cm (p/n: 1700019584)
- 1 x COM Cable 22cm (p/n: 1701200220)
- 2 x USB cable 25cm (p/n:1700018730)
- 1 x COM2 cable 30cm (p/n:1700019414)
- 1 x Startup manual (p/n: 2006936600)
- 1 x Mini Jumper(10pcs package) (p/n: 9689000002)

If any of these items are missing or damaged, contact your distributor or sales representative immediately.

Optional Accessories

Part number	Description
-------------	-------------

Contents

Chapter 1	General Information	1
1.1	Introduction	2
1.2	Specifications	2
1.2.1	Functional Specifications	2
1.2.2	OS support	4
1.2.3	Mechanical Specifications	4
1.2.4	Electrical Specifications	4
1.2.5	Environmental	4
1.3	Block Diagram	5
1.4	Board layout: dimensions	5
	Figure 1.1 PCM-9366 Mechanical Drawing (Top Side)	5
	Figure 1.2 PCM-9366 Mechanical Drawing (Bottom Side)	6
	Figure 1.3 PCM-9366 Mechanical Drawing (Coastline)	6
Chapter 2	Installation	7
2.1	Jumpers & Switches	8
	Table 2.1: Jumpers & Switches	8
2.2	Connectors	8
	Table 2.2: Connectors	8
2.3	Locating Connectors	9
	Figure 2.1 PCM-9366 Connector Locations (Top Side)	9
	Figure 2.2 PCM-9366 Connector Locations (Bottom Side)	9
2.4	Setting Jumpers	10
2.4.1	Clear CMOS (J1)	10
	Table 2.3: Clear CMOS (J1)	10
2.4.2	Auto Power On Setting (J3)	10
	Table 2.4: Auto Power On Setting (J3)	10
2.4.3	LCD Power (J4)	11
	Table 2.5: LVDS1 Power (J4)	11
2.4.4	LVDS VCON Setting (J5)	11
	Table 2.6: LVDS2 Power (J5)	11
Chapter 3	AMI BIOS Setup	13
3.1	Entering Setup	15
3.1.1	Main Setup	15
3.1.2	Advanced BIOS Features Setup	16
3.1.3	Chipset Configuration	28
3.1.4	Security	37
3.1.5	Boot	38
3.1.6	Save & Exit	39
Appendix A	Pin Assignments	41
A.1	Jumper List	42
A.2	Connector Pin Definition	43
Appendix B	System Assignments	65
B.1	System I/O Ports	66

B.2	1st MB Memory Map	66
	Table B.2: 1st MB Memory Map	66
B.3	Interrupt Assignments	67
	Table B.3: Interrupt assignments	67

Appendix D **EC Watchdog Timer Sample Code .. 69**

D.1	EC Watchdog Timer sample code	70
-----	-------------------------------------	----

Chapter 1

General Information

This chapter gives background information on the PCM-9366.

Sections include:

- Introduction
- Specifications
- Block diagram
- Board layout and dimensions

1.1 Introduction

PCM-9366 is 3.5" form factor (146 x 102 mm) and powered by the latest generation of Intel® Pentium N4200 Celeron N3350 & Atom™ E3950/E3940/E3930 processors which have low power features but also good performance computing, especially for multimedia capabilities compared to earlier generations. Meanwhile, PCM-9366 offers flexible expansion possibilities: M.2 key E, full-size mSATA and 9-36V wide range power input.

PCM-9366 supports various display interfaces including HDMI, VGA, 48-bit LVDS/*eDP, and rich I/O: 2 GbE, rich I/O: 4COM, SATA, USB3.0, SMBus/I2C (optional), 2 8bit GPIO, 2 CANBUS.

1.2 Specifications

1.2.1 Functional Specifications

■ Processor:

- Intel® Pentium N4200 1.1 GHz (burst frequency 2.5GHz) Quad Core, Four Threads
- Celeron® N3350 1.1(burst frequency 2.4GHZ), Dual Core (burst frequency 2.42GHz), Quad Cores, Four Threads
- Atom™ E3950/40/30,1.6/1.6/1.3GHz, Quad/Quad/Dual Cores, Two Threads
- Cache Hierarchy
 - * 32 KB 8-way L1 instruction cache and 24 KB 6-way L1 data cache per core
 - * 1 MB, 16-way L2 cache, shared per two cores
- Supported C-states: C0, C1, C6, C7
- Advanced Technologies
 - * Intel® Virtualization Technology (VT-x)
 - * Intel® 64 Architecture
 - * Enhanced Intel SpeedStep Technology
 - * Intel® Trusted Execution Engine (TXE)
- Power Management
 - * ACPI 5.0
 - * System sleep states: S0, S3, S4, S5

■ System Memory Support

- Dual Channel ECC, DDR3L SODIMM up to 8GB
- 64 bit data bus
- 2x64 DDR3L 1867
- 4x32 LPDDR4 2400
- 38.4 GB/s (@2400 MT/s); 29.9 GB/s (@1867 MT/s)
- Aggressive power management to reduce power consumption

■ Graphic and Media Engine

- Intel® 9th generation (Gen 9) graphics and media encode/decode engine
- GFX:
- Graphic Features:
 - * 3D HW Acceleration: DirectX* 11.3/12,
 - * 4K Decode for HEVC4, H.264, VP8;

- * 4K Encode for H.264, VP8
- Multi-display interfaces: VGA, /HDMI (default)/(DP*), 48-bit LVDS/eDP (default LVDS). MIOe's DisplayPort interface is shared with DisplayPort on rear I/O.
 - * Supports Extend/ Clone Mode with multi-display device
 - * Dual display: any two combination between VGA, /HDMI/DP/MIOe's DisplayPort, LVDS/eDP
- Specification and Resolution
 - * VGA port: CH7517A-BF Maximum Resolution up to 1920x1200
 - * or DP*-DP 1.2a (4096x2160@60Hz)/1.4b (3840x2160@30Hz)
 - * eDP v1.4 4096x2160@ 60Hz / LVDS 48bit:
 - * Inverter power: 1A @ 5V/12V
- 3D HW Acceleration: OpenGL* 4.2, DirectX* 12, OpenCL* 2.0
- HW Video Decode: H.264, VC-1, WMV9, H.265/HEVC, VP8, VP9, JPEG/ MJPEG
- HW Video Encode: H.264, MVC, H.265/HEVC, VP8, VP9, JPEG/MJPEG
- **Gigabit Ethernet**
 - Controller: Intel® i210
 - * 10/100/1000 BASE-T
 - * IEEE 802.3az Energy Efficient Ethernet (EEE), which defines Low Power Idle (LPI) state
 - * IEEE 1588/802.1AS precision time synchronization
 - * 9.5 KB Jumbo frames supported (Full-duplex)
 - * Flow Control supported
 - * Magic packet wake-up enable with unique MAC address
- **Peripheral interface**
 - DMA operation
 - * SATA Power: 5V / 12V
 - 2 x USB 3.0 & 4 x USB 2.0
 - * Two USB3.0 on rear I/O, four internal USB2.0
 - * USB3.0 SuperSpeed (SS), implements xHCI software host controller interface
 - * Multiplexed with EHCI controller that are High-Speed/Full-Speed (HS/FS)
 - * USB source: USB3.0 and USB2.0's dual port on rear I/O's USB signal directly from CPU, internal USB + mini PCIe
 - * Support wake-up from sleeping state S3
 - * Power supply: 0.5A @ 5V for USB2.0, 1A @ 5V for USB3.0
 - 2 RS-232 for COM1/2, 2 RS-232/422/485 for COM3/4 (ESD protection: air gap ± 15 kV, contact ± 8 kV)
 - 16-bit Programmable General Purpose Input/ Output from iManager (5V tolerance)
 - 1 SMBus/I2C (optional) channel from iManager
 - Watchdog timer: Output System Reset, Programmable counter from 1 ~ 255 minutes/ seconds
 - Mini PCIe / mSATA
 - * 1 Full-size mSATA (with SATA and USB interface)
 - * Power supply: 1.1 A @ 3.3 V, 0.375 A @ 1.5 V
 - M.2 Key E

1 M.2 Key E (2230) slot (with PCIe and USB interface)

■ **High Definition Audio:**

- Intel® High Definition Audio Interface
- High Definition Audio Codec with Realtek proprietary loss-less content protection technology
- Supports 1 Line-input, 1 Line output, 1 Mic-input

■ **BIOS**

- AMI UEFI 64 Mbit, BIOS for 64 or 32bit is different, default version is for 64bit
- Default setting is UEFI boot

1.2.2 OS support

PCM-9366 supports Win10 (support UEFI mode), Linux Yocto Project BSP, VxWorks, Android 64 bit (Support by request).

For further information about OS support of PCM-9366, please visit Advantech website: <http://support.advantech.com.tw/> or contact the technical support center.

1.2.3 Mechanical Specifications

- **Dimensions:** 146 x 102 mm (5.7 x 4 inches)
- **Height:** top side 19.5mm, PCB 1.6mm, bottom side 7.8mm, total 28.9mm
- **Weight:** 0.5 kg (reference weight of total package)

1.2.4 Electrical Specifications

- **Power Requirement:** 9-36V wide range DC \pm 10% power input
- **Power Consumption:**
 - Max load: E3950: 1.16A @ 12V (13.92W)
 - Idle mode: E3950: 0.37A @ 12V (4.44W)
- **Power Consumption Conditions:**
 - Test software: 3DMark 2006
 - Max. load: Measure the maximum current value which system under maximum load (CPU: Top speed, RAM & Graphic: Full loading)
 - Idle mode: Measure the current value when system in windows mode and without running any program
- **RTC Battery:**
 - Typical Voltage: 3.0 V
 - Normal discharge capacity: 210 mAh

1.2.5 Environmental

- **Operating Temperature:** 0 ~ 60°C (32 ~ 140°F)
- **Operating Humidity:** 40°C @ 95% RH Non-Condensing
- **Storage Temperature:** Storage temperature: -40~85°C
- **Storage Humidity:** Relative humidity: 95% @ 60°C

1.3 Block Diagram

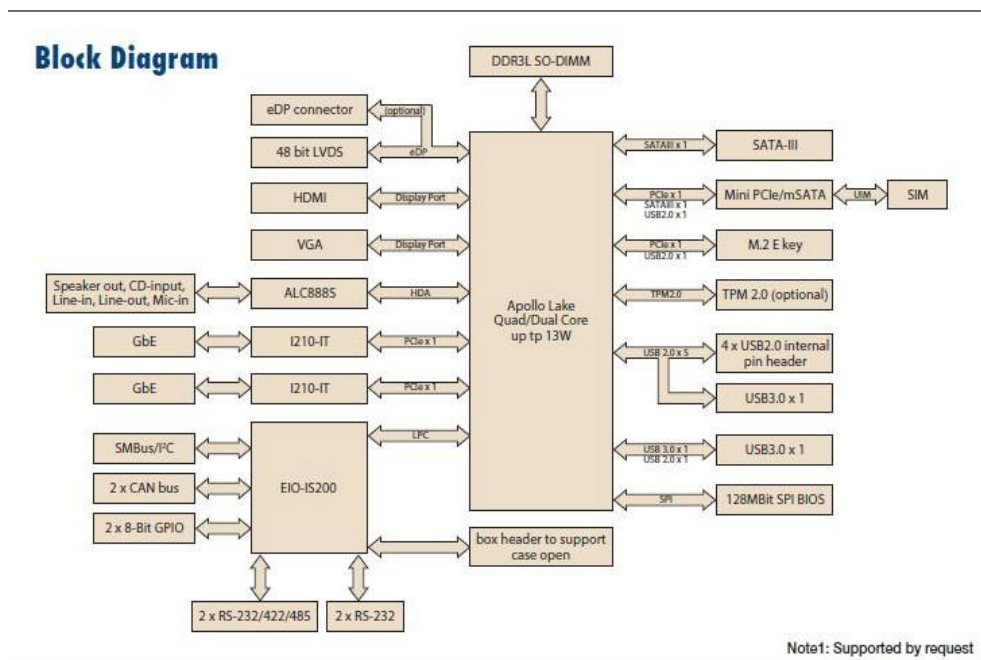

1.4 Board layout: dimensions

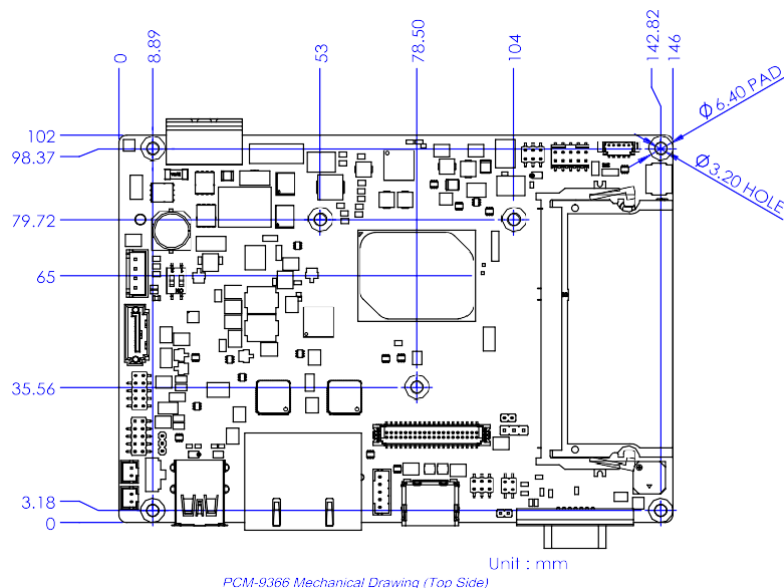
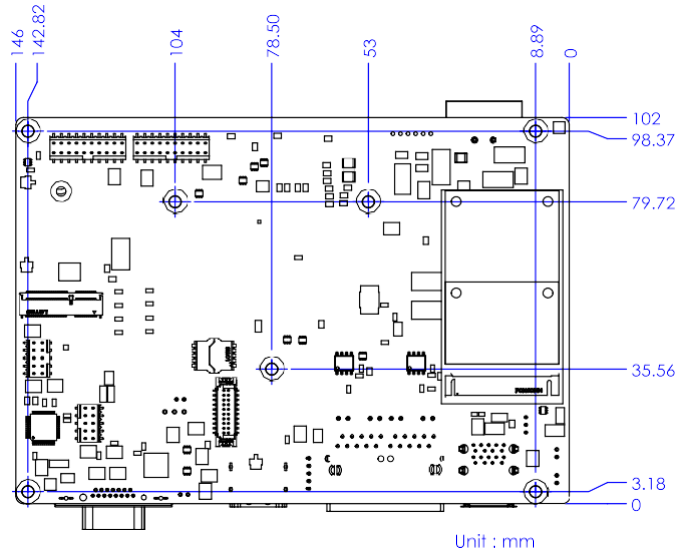
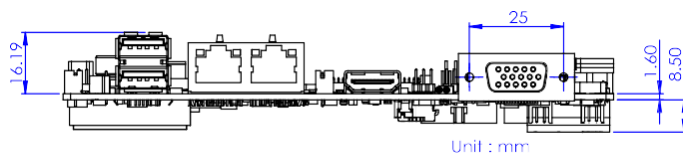

Figure 1.1 PCM-9366 Mechanical Drawing (Top Side)



PCM-9366 Mechanical Drawing (Bottom Side)

Figure 1.2 PCM-9366 Mechanical Drawing (Bottom Side)



PCM-9366 Mechanical Drawing (Side View)

Figure 1.3 PCM-9366 Mechanical Drawing (Coastline)

Chapter 2

Installation

This chapter explains the setup procedures of the PCM-9366 hardware, including instructions on setting jumpers and connecting peripherals, switches and indicators. Be sure to read all safety precautions before you begin the installation procedure.

2.1 Jumpers & Switches

The PCM-9366 has a number of jumpers that allow you to configure your system to suit your application. The table below lists the functions of the various jumpers.

Table 2.1: Jumpers & Switches

J1	Clear CMOS
J3	Auto Power On Setting
J4	LCD Power
J5	LVDS VCON Setting

2.2 Connectors

Onboard connectors link the PCM-9366 to external devices such as hard disk drives, a keyboard, or floppy drives. The table below lists the function of each of the connectors.

Table 2.2: Connectors

Label	Function
J2	CASE OPEN
CN1	Power Input
CN3	Battery
CN4	SODIMMDDR3_204
CN5	IS200 Debug Port
CN6	CAN1/CAN2
CN7	for SW debug
CN8	Power Switch
CN9	Reset
CN10	RS232/422/485 *2 (COM3/COM4)
CN11	RS232 * 2 (COM1/COM2)
CN12	Audio
CN13	eDP
CN14	HDMI
CN16	LAN
CN18	VGA
CN19	Inverter Power Output
CN20	48-bit LVDS Panel
CN21	M.2 Key E
CN22	Full size mSATA
CN23	Internal USB
CN24	Internal USB
CN25	External USB3.0
CN26	SATA
CN27	HDD & PWR LED
CN28	LPC Debug Port
CN29	SATA Power
CN30	GPIO
CN31	GPIO
CN32	SMBus/I2C (optional)
CN33	SIM

2.3 Locating Connectors

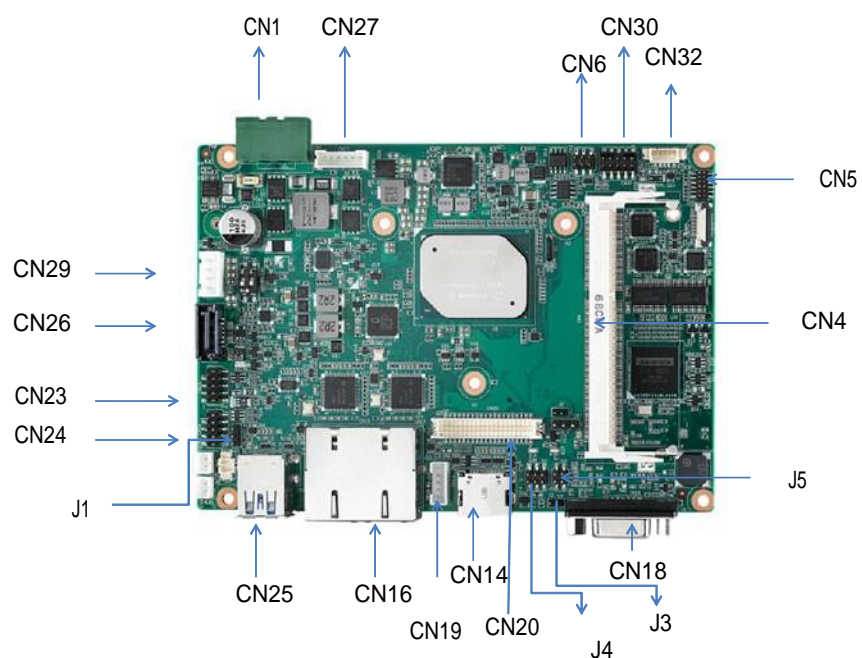

Figure 2.1 PCM-9366 Connector Locations (Top Side)

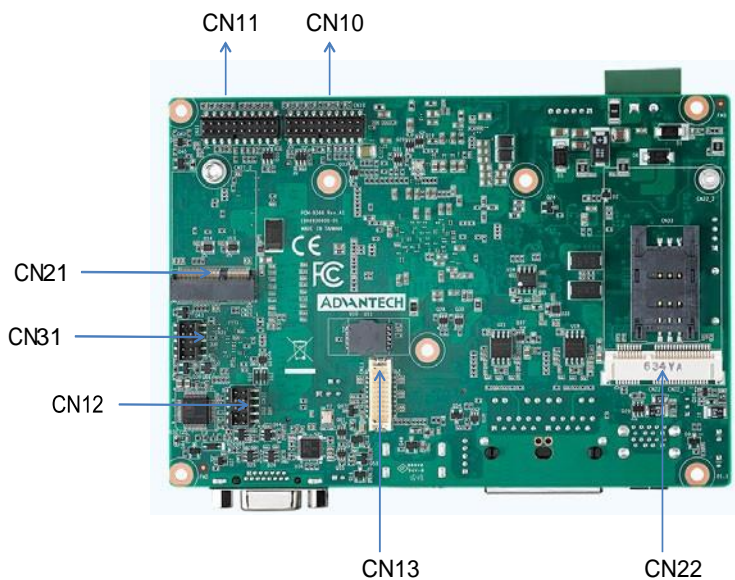
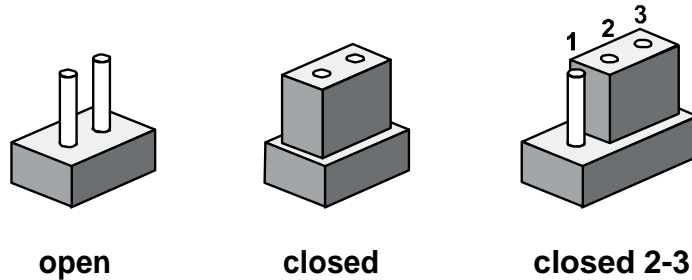

Figure 2.2 PCM-9366 Connector Locations (Bottom Side)

2.4 Setting Jumpers

You may configure your card to match the needs of your application by setting jumpers. A jumper is a metal bridge used to close an electric circuit. It consists of two metal pins and a small metal clip (often protected by a plastic cover) that slides over the pins to connect them. To “close” a jumper, you connect the pins with the clip. To “open” a jumper, you remove the clip. Sometimes a jumper will have three pins, labeled 1, 2 and 3. In this case you would connect either pins 1 and 2, or 2 and 3.

The jumper settings are schematically depicted in this manual as follows:



A pair of needle-nose pliers may be helpful when working with jumpers. If you have any doubts about the best hardware configuration for your application, contact your local distributor or sales representative before you make any changes. Generally, you simply need a standard cable to make most connections.

2.4.1 Clear CMOS (J1)



Table 2.3: Clear CMOS (J1)

Setting	Function
(1-2)*	Normal (default)
(2-3)	Clear CMOS

2.4.2 Auto Power On Setting (J3)



Table 2.4: Auto Power On Setting (J3)

Setting	Function
NC	Power Button for Power On
(1-2)*	Auto Power On

* Default

2.4.3 LCD Power (J4)

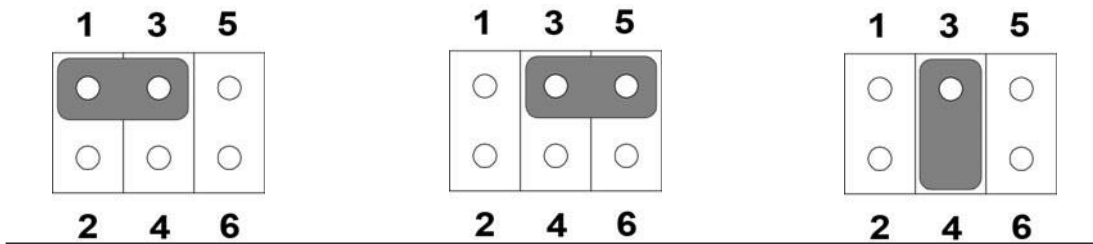

Table 2.5: LVDS1 Power (J4)

Setting	Function
(1-3)*	+3.3V (default)
(3-5)	+5V
(3-4)	+12V

2.4.4 LVDS VCON Setting (J5)

Table 2.6: LVDS2 Power (J5)

Setting	Function
(1-2)*	3.3V High for VCON on LVDS
(1-3)	Low for VCON on LVDS
(3-4)	+12V

Chapter 3

AMI BIOS Setup

AMIBIOS has been integrated into a plethora of motherboards for decades. With the AMIBIOS Setup program, you can modify BIOS settings and control the various system features. This chapter describes the basic navigation of the PCM-9366 BIOS setup screens.



AMI BIOS ROM has a built-in Setup program that allows users to modify the basic system configuration. This information is stored in battery-backed CMOS so it retains the Setup information when the power is turned off.

3.1 Entering Setup

Turn on the computer and check for the patch code. If there is a number assigned to the patch code, it means that the BIOS supports your CPU. If there is no number assigned to the patch code, please contact an Advantech application engineer to obtain an up-to-date patch code file. This will ensure that your CPU's system status is valid. After ensuring that you have a number assigned to the patch code, press and you will immediately be allowed to enter Setup.

3.1.1 Main Setup

When you first enter the BIOS Setup Utility, you will encounter the Main setup screen. You can always return to the Main setup screen by selecting the Main tab. There are two Main Setup options. They are described in this section. The Main BIOS Setup screen is shown below.



The Main BIOS setup screen has two main frames. The left frame displays all the options that can be configured. Grayed-out options cannot be configured; options in blue can. The right frame displays the key legend.

Above the key legend is an area reserved for a text message. When an option is selected in the left frame, it is highlighted in white. Often a text message will accompany it.

- **System time / System date**

Use this option to change the system time and date. Highlight System Time or System Date using the <Arrow> keys. Enter new values through the keyboard. Press the <Tab> key or the <Arrow> keys to move between fields. The date must be entered in MM/DD/YY format. The time must be entered in HH:MM:SS format.

3.1.2 Advanced BIOS Features Setup

Select the Advanced tab from the PCM-9366 setup screen to enter the Advanced BIOS Setup screen. You can select any of the items in the left frame of the screen, such as CPU Configuration, to go to the sub menu for that item. You can display an Advanced BIOS Setup option by highlighting it using the <Arrow> keys. All Advanced BIOS Setup options are described in this section. The Advanced BIOS Setup screens is shown below. The sub menus are described on the following pages.

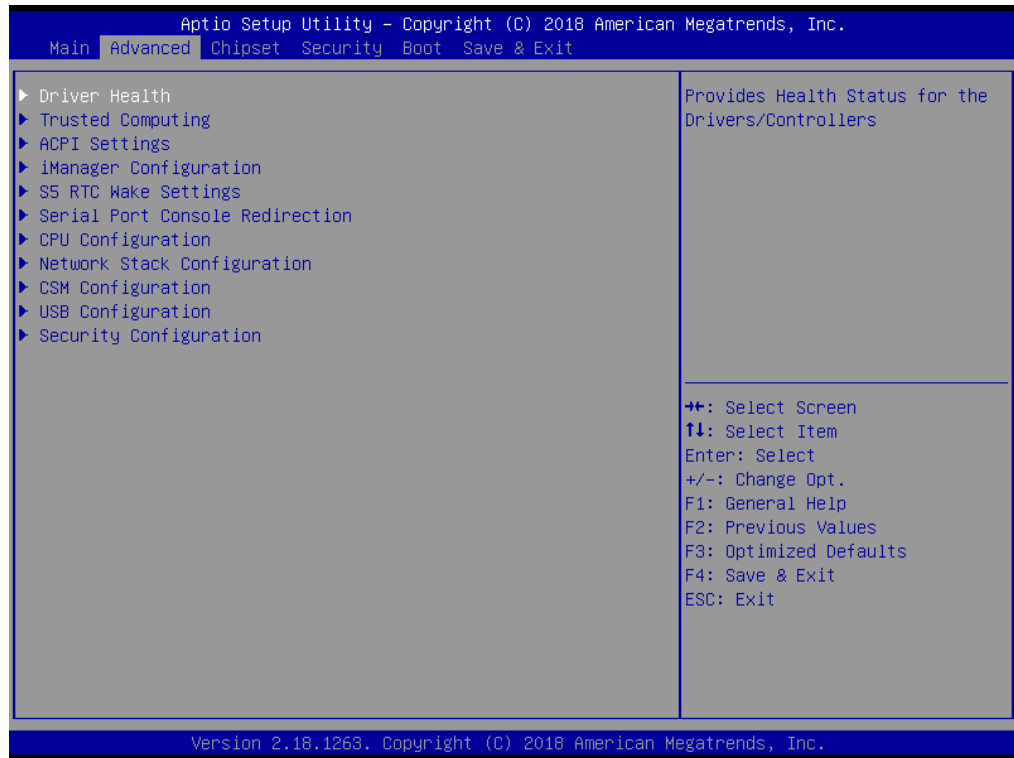

3.1.2.1 Driver Health



Provide Health Status for the Drivers/Controllers.

3.1.2.2 Trusted Computing

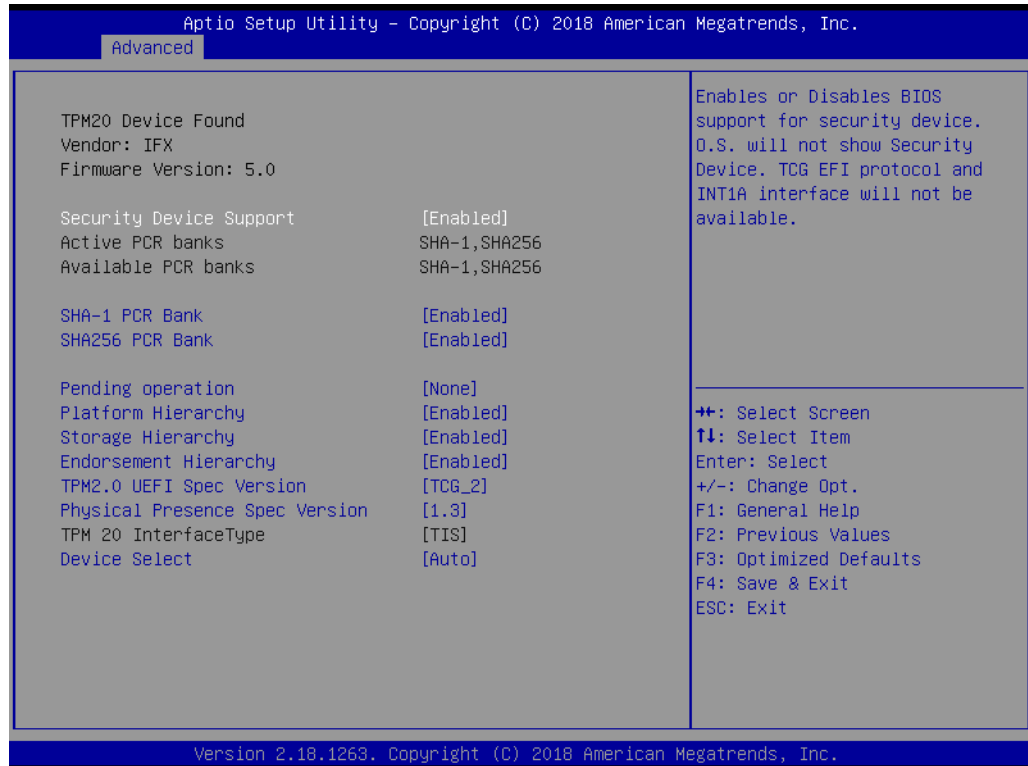

- **Security Device Support**
Enable or disable BIOS support for security device.
- **SHA-1 PCR Bank**
Enable or Disable SHA-1 PCR Bank.
- **SHA256 PCR Bank**
Enable or Disable SHA256 PCR Bank.
- **Pending operation**
Schedule an Operation for the Security Device.
- **Platform Hierarchy**
Enable or Disable Platform Hierarchy.
- **Storage Hierarchy**
Enable or Disable Storage Hierarchy.
- **Endorsement Hierarchy**
Enable or Disable Endorsement Hierarchy.
- **TPM 2.0 UEFI Spec Version**
Select the TCG2 Spec Version Support.
- **Physical Presence Spec Version**
Select to Tell O.S. to support PPI Spec Version 1.2 or 1.3.
- **Device Select**
TPM 1.2 will restrict support to TPM 1.2 devices, TPM 2.0 will restrict support to TPM 2.0 devices.

3.1.2.3 ACPI Settings

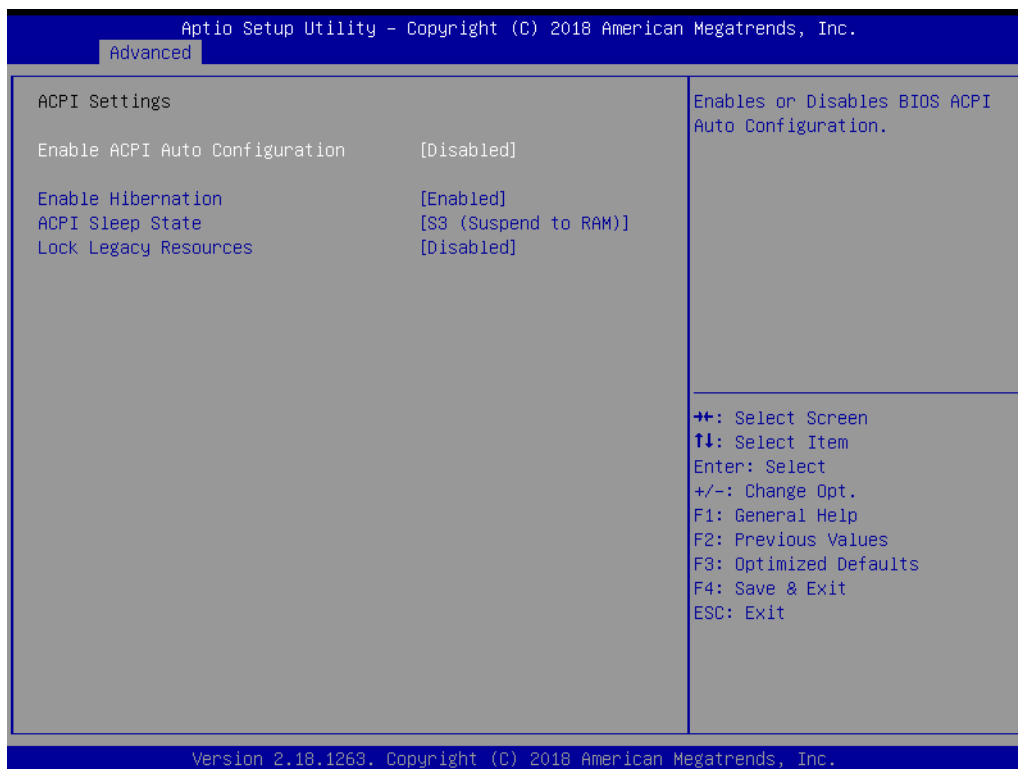

- **Enable ACPI Auto Configuration**
Enable or disable BIOS ACPI auto configuration.
- **Enable Hibernation**
Enables or Disables System ability to Hibernate (OS/S4 Sleep State). This option may be not effective with some OS.
- **ACPI Sleep State**
Select the highest ACPI sleep state the system will enter when the SUSPEND button is pressed.
- **Lock Legacy Resources**
Enables or Disables Lock of Legacy Resources

3.1.2.4 iManager Configuration

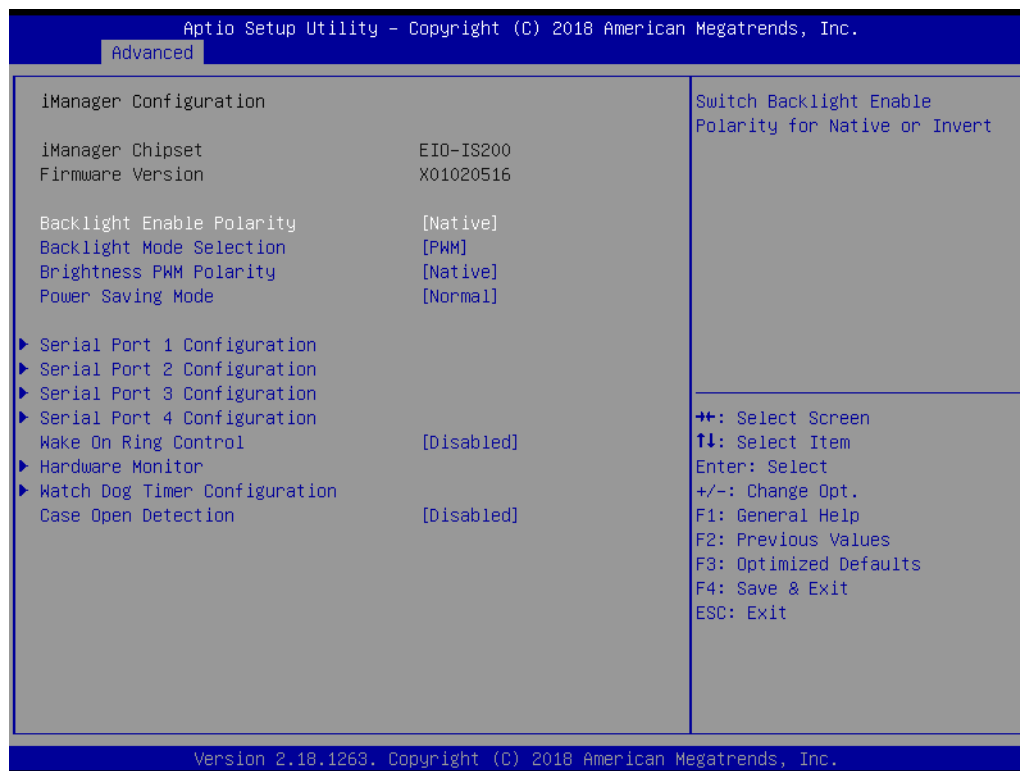

- **Backlight Enable Polarity**
Switch Backlight Enable Polarity for Native or Invert.
- **Backlight Mode Selection**
Switch Backlight Control to PWM or DC modet.
- **Brightness PWM Polarity**
Switch Backlight Control Brightness PWM Polarity for Native or Invert.
- **Power Saving Mode**
This item allows users to set board's power saving mode when off.
- **Serial Port 1 Configuration**
Set Parameters of Serial Port 1 (COMA).
- **Serial Port 2 Configuration**
Set Parameters of Serial Port 2 (COMB).
- **Serial Port 3 Configuration**
Set Parameters of Serial Port 3 (COMC).
- **Serial Port 4 Configuration**
Set Parameters of Serial Port 4 (COMD).
- **Wake On Ring Control**
Enable/Disable Wake On Ring Function.
- **Hardware Monitor**
Monitor hardware statue.
- **Watch Dog Timer Configuration**
Watch Dog Timer Configuration Page.
- **Case Open Detection**
Enabled or Disabled Case Open Detect Funton.

HW Monitor

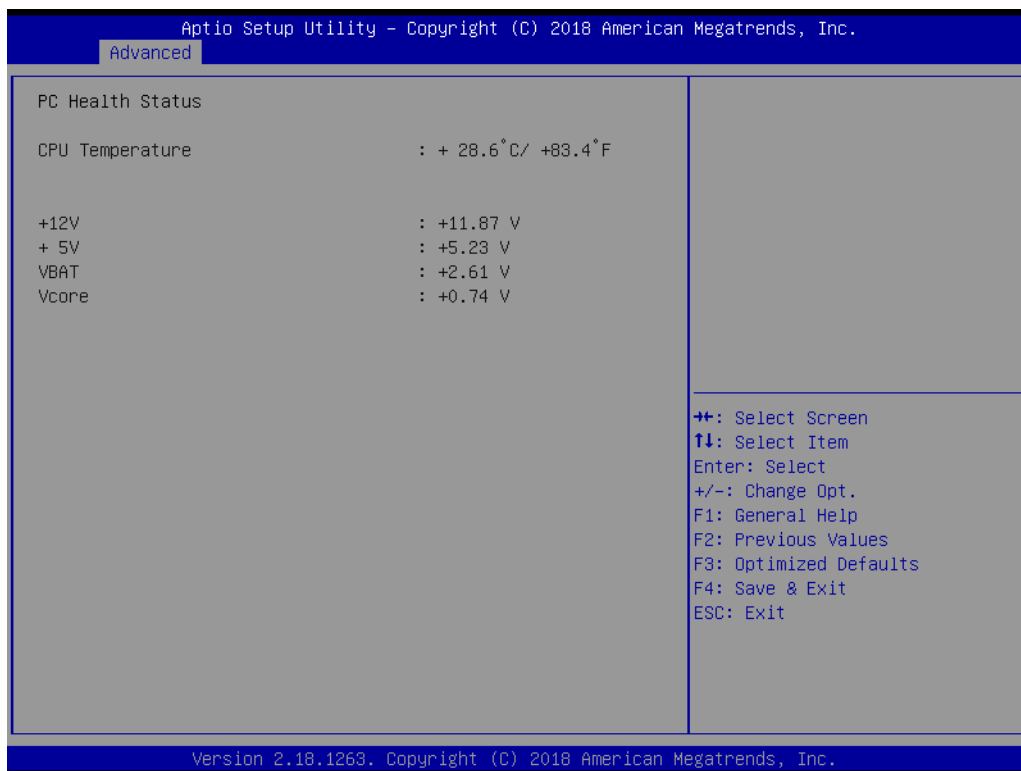

- **PC Health Status**
This page displays all information about system Temperature/Voltage.

Watch Dog Timer Configuration



- **Watch Dog Timer**

This page displays all information about Watch Dog Timer Configuration.

3.1.2.5 S5 RTC Wake Settings

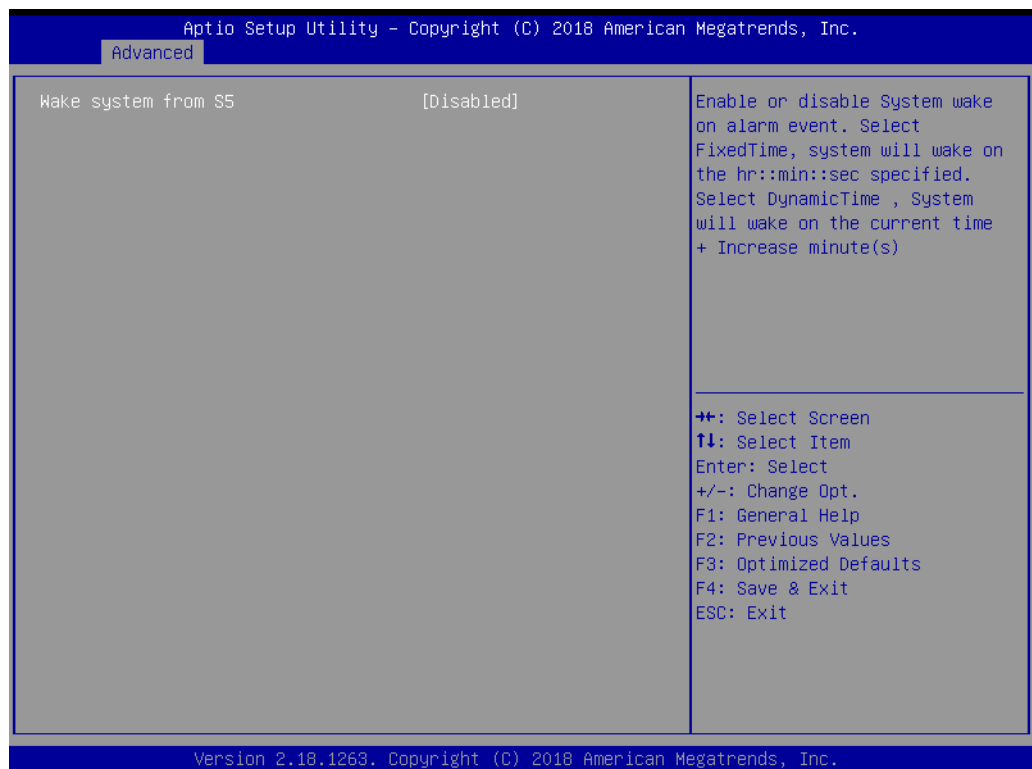

- **Wake system from S5**

Enable or disable System wake on alarm event. Select FixedTime, system will

wake on the hr::min::sec specified.

3.1.2.6 Serial Port Console Redirection

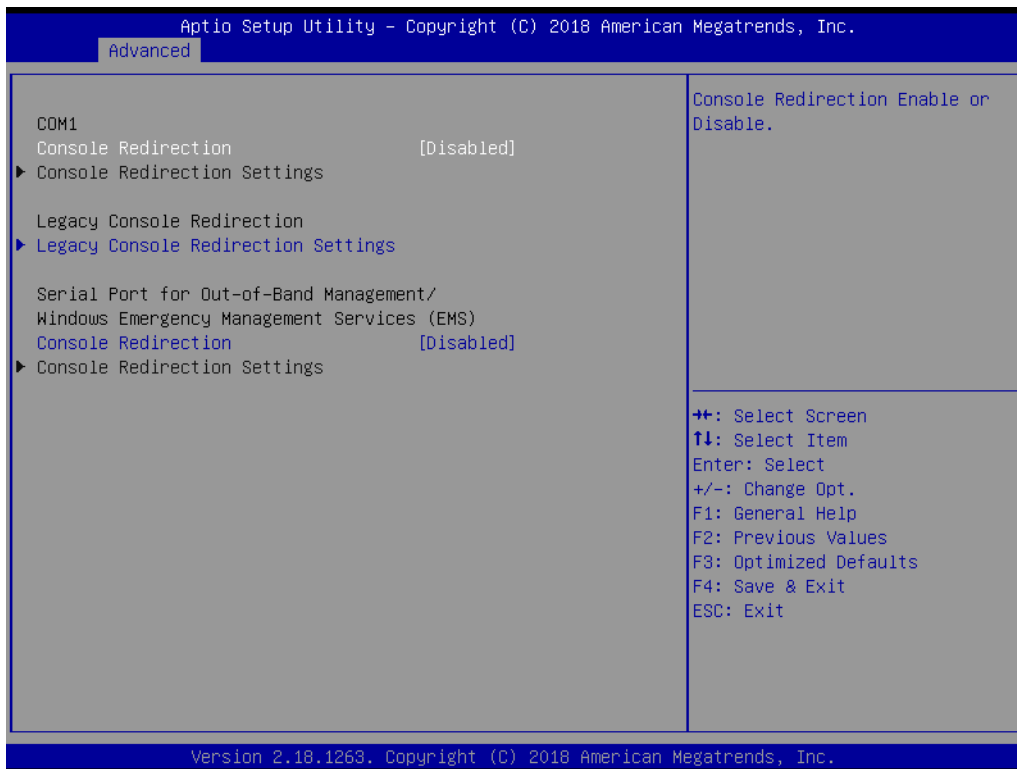

- **Console Redirection**
This item allows users to enable or disable console redirection for Microsoft Windows Emergency Management Services (EMS).
- **Console Redirection**
This item allows users to configuration console redirection detail settings.

3.1.2.7 CPU Configuration

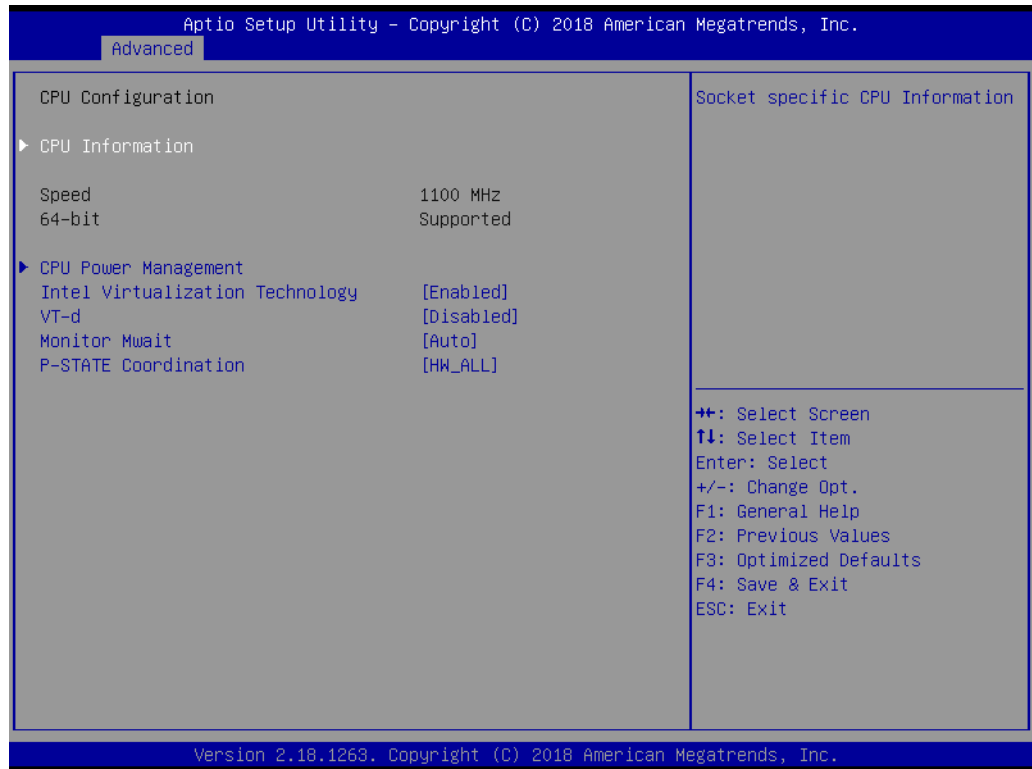

- **Intel Virtualization Technology**
When enabled, a VMM can utilize the additional hardware capabilities provided by Vanderpool Technology.
- **VT-d**
Enable/Disable CPU VT-d.
- **Monitor Mwait**
Enable/Disable Monitor Mwait.
- **P-STATE Coordination**
Change P-STATE Coordination type.

3.1.2.8 Network Stack Configuration

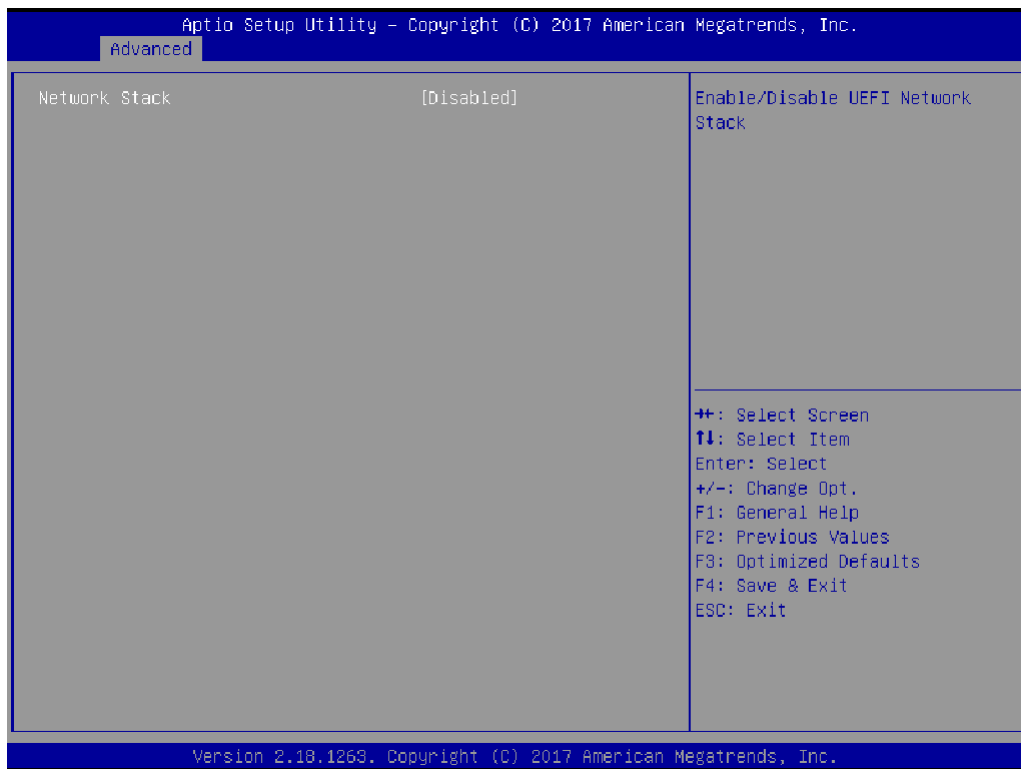

- **Network Stack**
Enable/Disable UEFI Network Stack.

3.1.2.9 CSM Configuration



CSM Support for debug purpose

- **CSM Support**
Enable/Disable CSM Support.
- **GateA20 Active**
UPON REQUEST - GA20 can be disabled using BIOS services. ALWAYS - do not allow disabling GA20; this option is useful when any RT code is executed above 1MB.
- **INT19 Trap Response**
BIOS reaction on INT19 trapping by Option ROM: IMMEDIATE - execute the trap right away; POSTPONED - execute the trap during legacy boot.
- **Boot option filter**
This option controls Legacy/UEFI ROMs priority.
- **Network**
Controls the execution of UEFI and Legacy PXE OpROM.
- **Storage**
Controls the execution of UEFI and Legacy Storage OpROM.
- **Video**
Controls the execution of UEFI and Legacy Video OpROM.
- **Other PCI devices**
Determines OpROM execution policy for devices other than Network, Storage, or Video.

3.1.2.10 USB Configuration

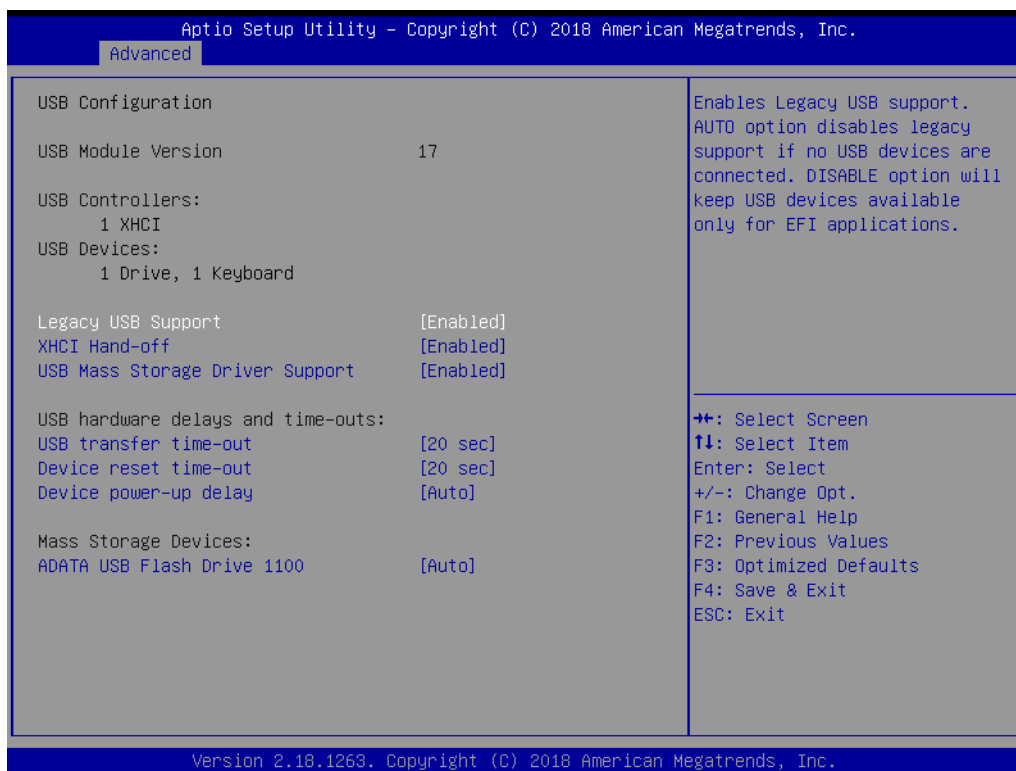

- **Legacy USB Support**
Enables Legacy USB support. AUTO option disables legacy support if no USB devices are connected. DISABLE option will keep USB devices available only for EFI applications.
- **XHCI Hand-off**
This is a workaround for OSES without XHCI hand-off support. The XHCI ownership change should be claimed by XHCI driver.
- **USB Mass Storage Driver Support**
Enable/Disable USB Mass Storage Driver Support.
- **USB transfer time-out**
Time-out value for control, Bulk, and interrupt transfers.
- **Device reset time-out**
USB mass storage device start unit command time-out.
- **Device power-up delay**
Maximum time the device will take before it properly reports itself to the Host Controller. 'Auto' uses default value: for a Root port it is 100 ms, for a Hub port the delay is taken from Hub descriptor.

3.1.2.11 Security Configuration

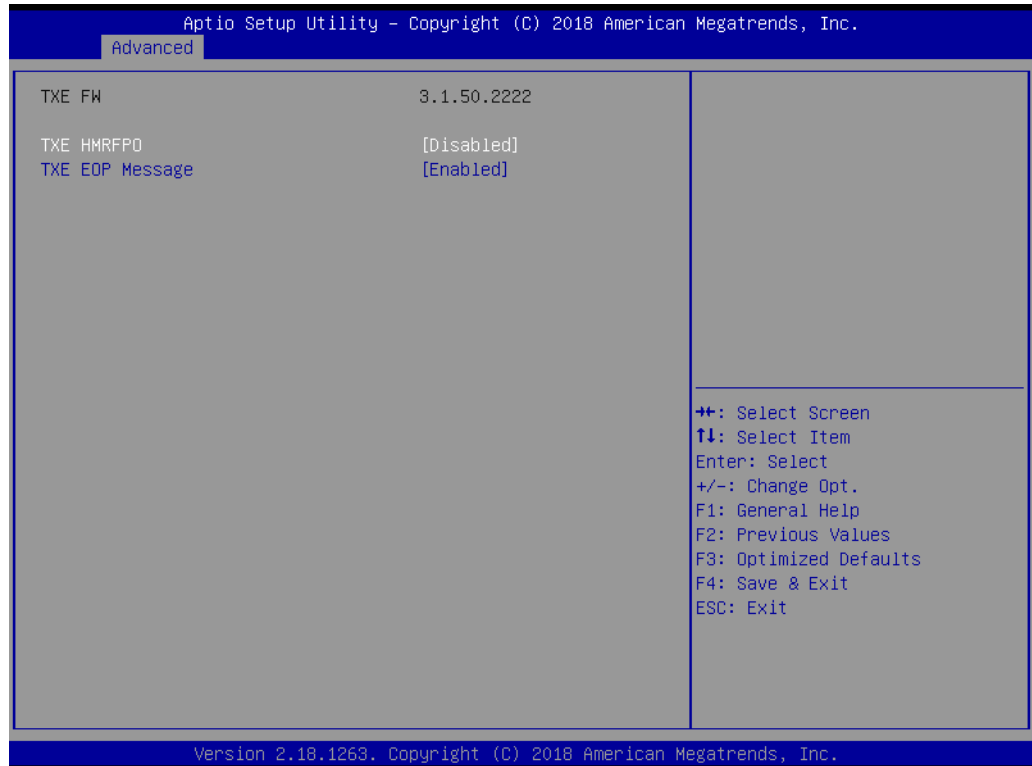

- **TXE HMRFPD Disable**
- **TXE EOP Message**
Send EOP Message Before Enter OS

3.1.3 Chipset Configuration

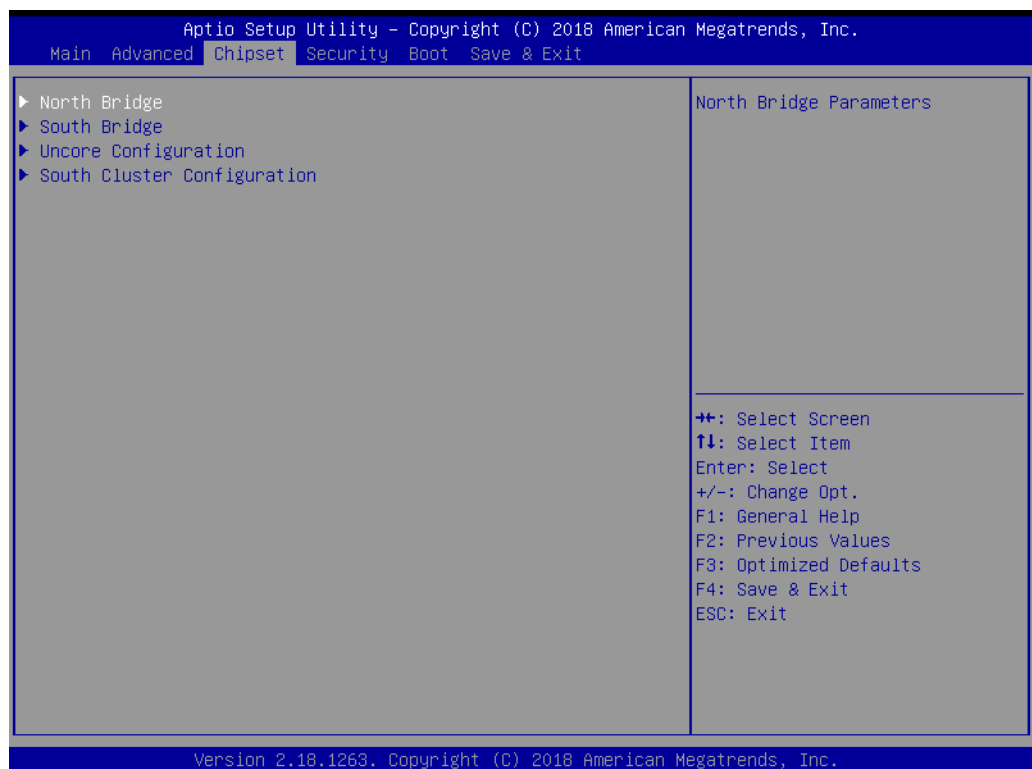

- **North Bridge**
Details for North Bridge items.
- **South Bridge**
Details for South Bridge items.
- **Uncore Configuration**
Details for Uncore Configuration.
- **South Cluster Configuration**
Details for South Cluster Configuration.

3.1.3.1 North Bridge

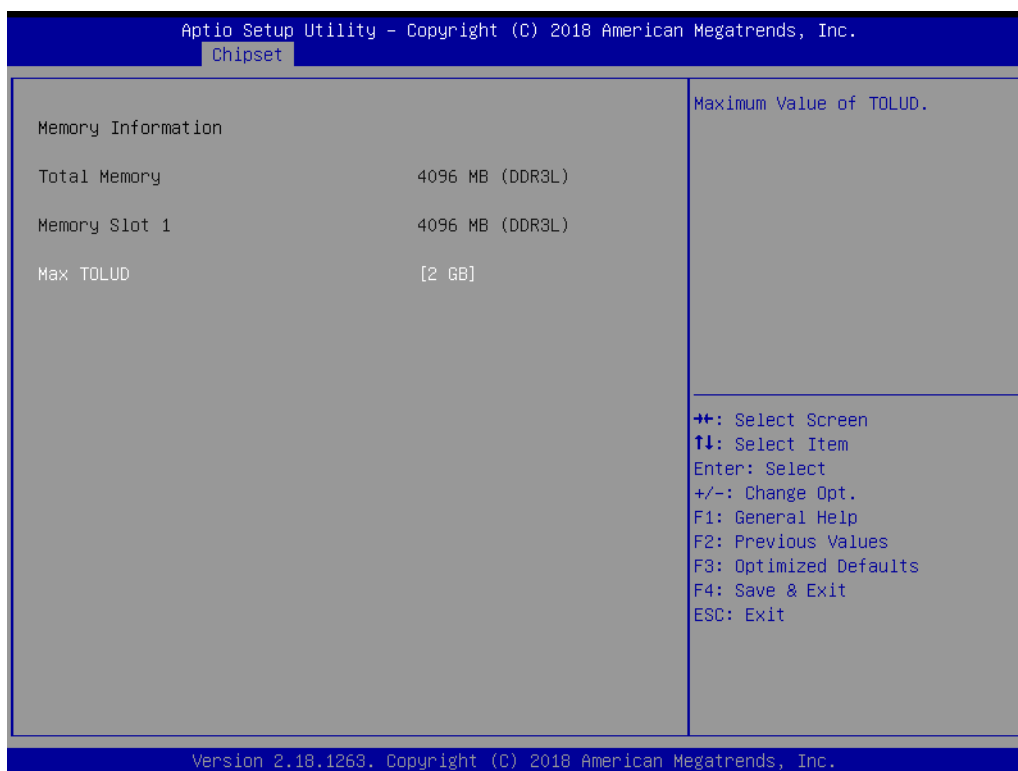

- **Max TOLUD**
Maximum Value of TOLUD.

3.1.3.2 South Bridge

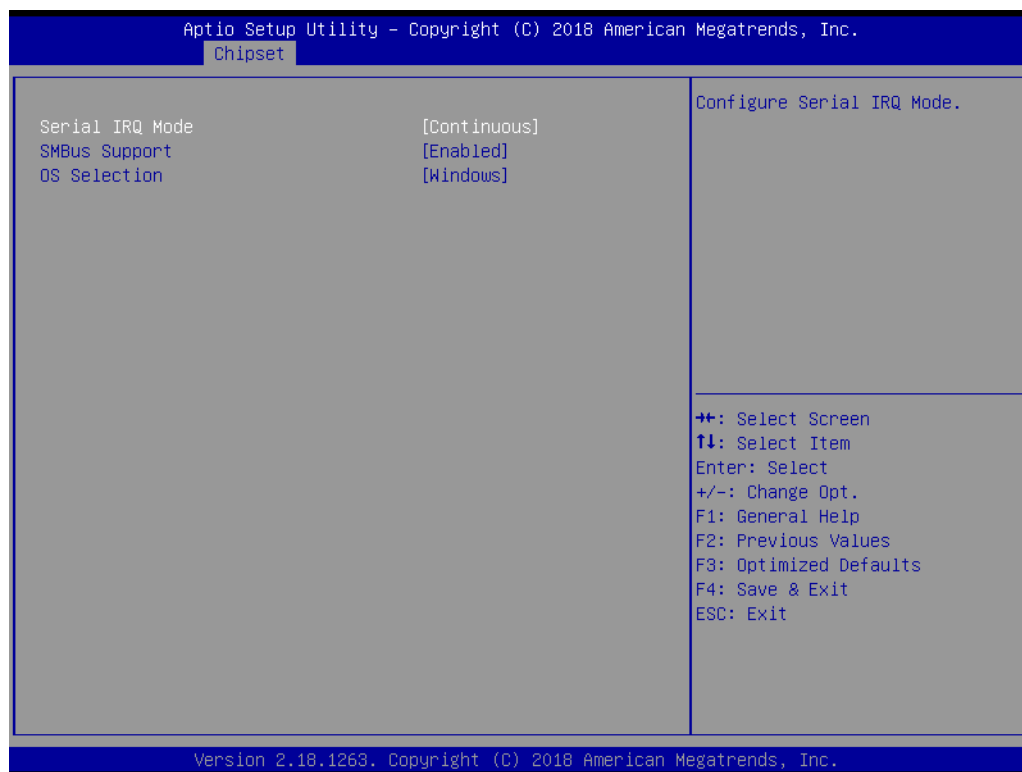

- **Serial IRQ Mode**
Configure Serial IRQ Mode.
- **SMBus Support**
Enable/Disable SMBus Support.
- **OS Selection**
Select the target OS.

3.1.3.3 Uncore Configuration

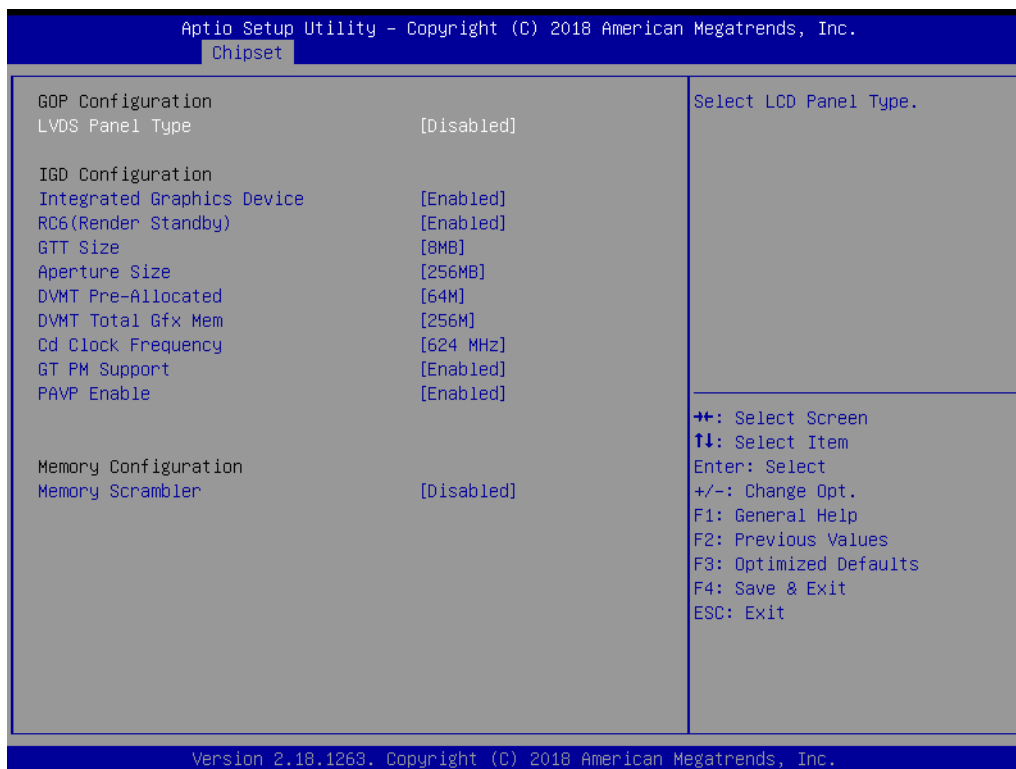

- **LVDS Panel Type**
Select LCD Panel Type.
- **Integrated Graphics Device**
Enable : Enable Integrated Graphics Device (IGD) when selected as the Primary Video Adaptor. Disable : Always disable IGD.
- **RC6 Render Standby**
Check to enable render standby support.
- **GTT Size**
Select the GTT Size
- **Aperture Size**
Select the Aperture Size.
- **DVMT Pre-Allocated**
Select DVMT 5.0 Pre-Allocated (Fixed) Graphics Memory size used by the Internal Graphics Device.
- **DVMT Total Gfx Mem**
Select DVMT 5.0 Total Graphic Memory size used by the Internal Graphics Device.
- **Cd Clock Frequency**
Select the highest Cd Clock frequency supported by the platform.
- **GT PM Support**
Enable/Disable GT PM Support.
- **PAVP Enable**
Enable/Disable PAVP.
- **Memory Scrambler**
Enable/Disable Memory Scrambler support.

3.1.3.4 South Cluster Configuration

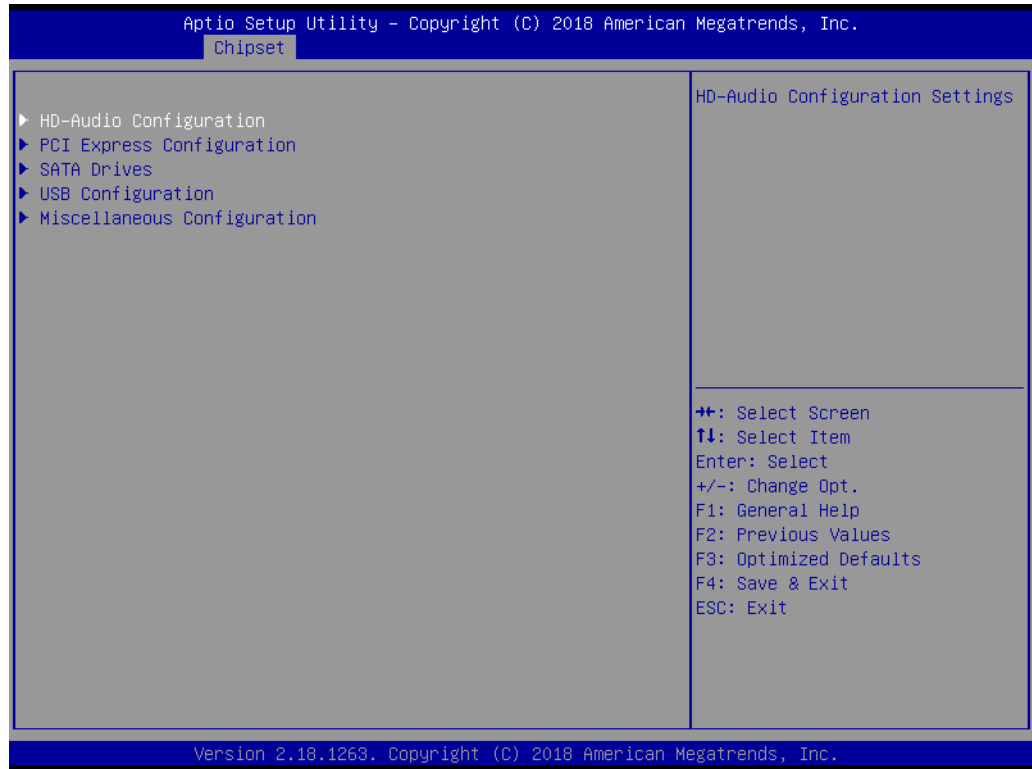

- **HD-Audio Configuration**
HD-Audio Configuration Settings.
- **PCI Express Configuration**
PCI Express Configuration Settings.
- **SATA Drives**
Press <Enter> to select the SATA Device Configuration Setup options.
- **USB Configuration**
USB Configuration Settings.
- **Miscellaneous Configuration**
Enable/Disable Misc. Features.

HD-Audio Configuration

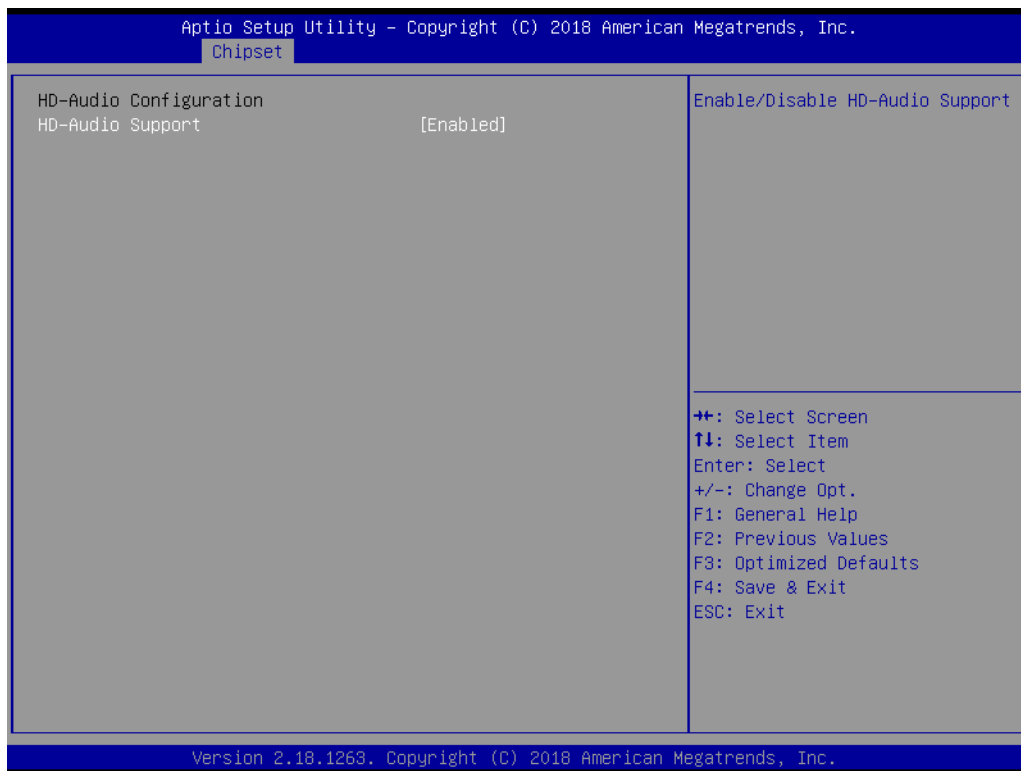

- **HD-Audio Support**
Enable/Disable HD-Audio Support.

PCI Express Configuration

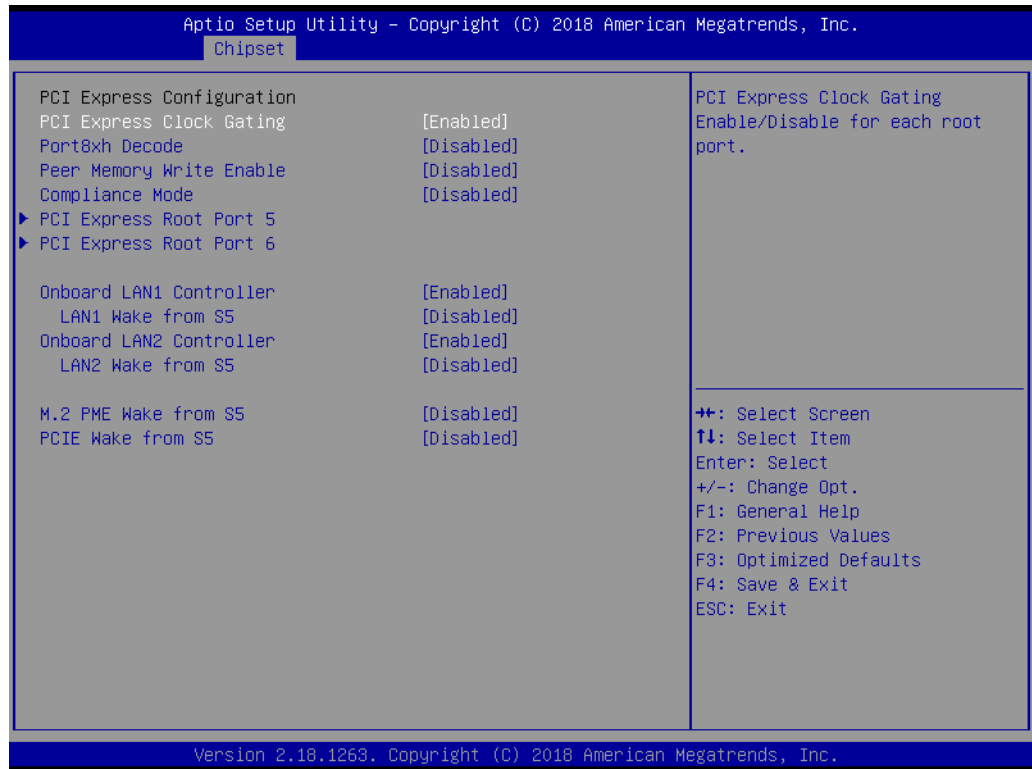

- **Compliance Mode**
Compliance Mode Enable/Disable.
- **PCI Express Root Port 5 / 6**
Control the PCI Express Root Port.
- **Onboard LAN1/2 Controller**
Select to Enable or Disable Onboard LAN1/2 Controller.
- **LAN Option ROM**
Enabled / Disabled Onboard LAN's PXE option ROM.
- **M.2 PME Wake from S5**
Enable or disable M.2 PME to wake the system from S5.
- **PCIE Wake from S5**
Enable or disable PCIE to wake the system from S5.

SATA Drives

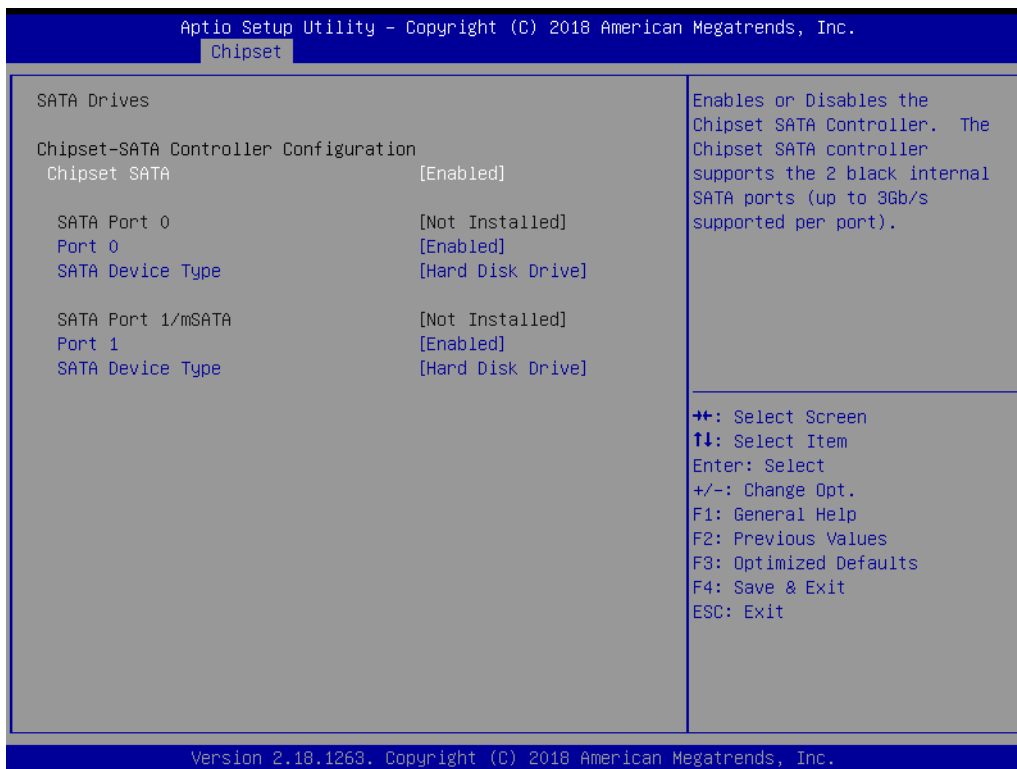

- **Chipset SATA**
Enable or Disable the Chipset SATA Controller.

USB Configuration

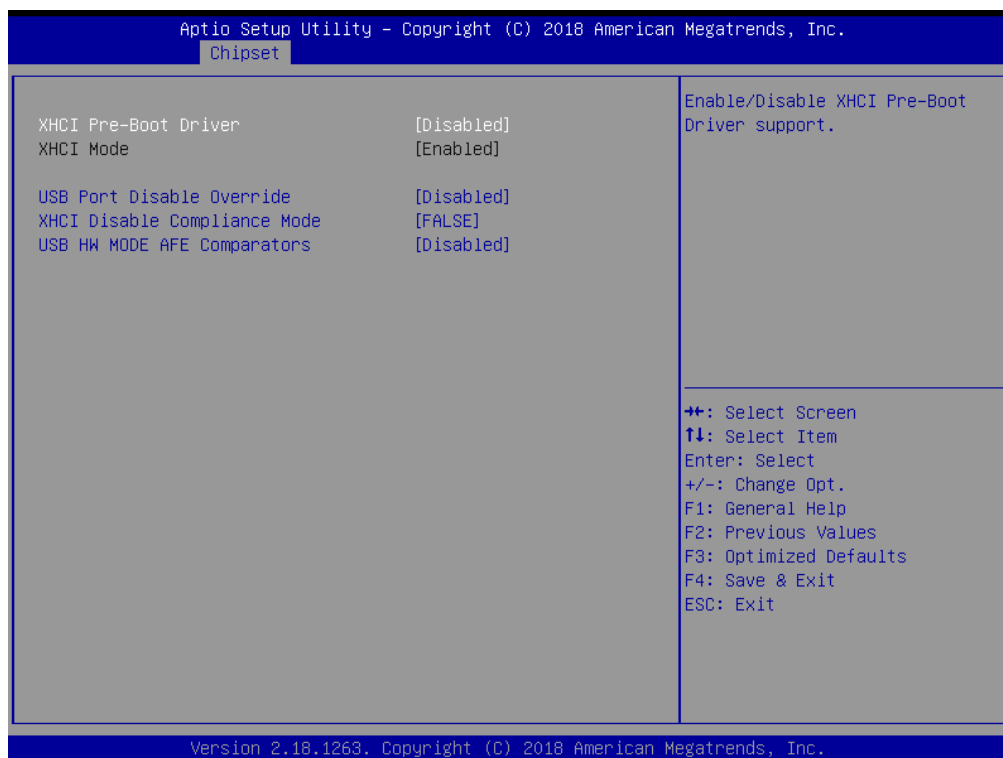

- **XHCI Pre-Boot Driver**
Enable/Disable XHCI Pre-Boot Driver Support.
- **USB Port Disable Override**
Selectively Enable/Disable corresponding USB port from reporting a Device Connection to the controller.
- **XHCI Disable Compliance Mode**
Options to disable XHCI Link Compliance Mode.
- **USB HW MODE AFE Comparators**
Enable/Disable USB HW MODE AFE Comparators.

Miscellaneous Configuration

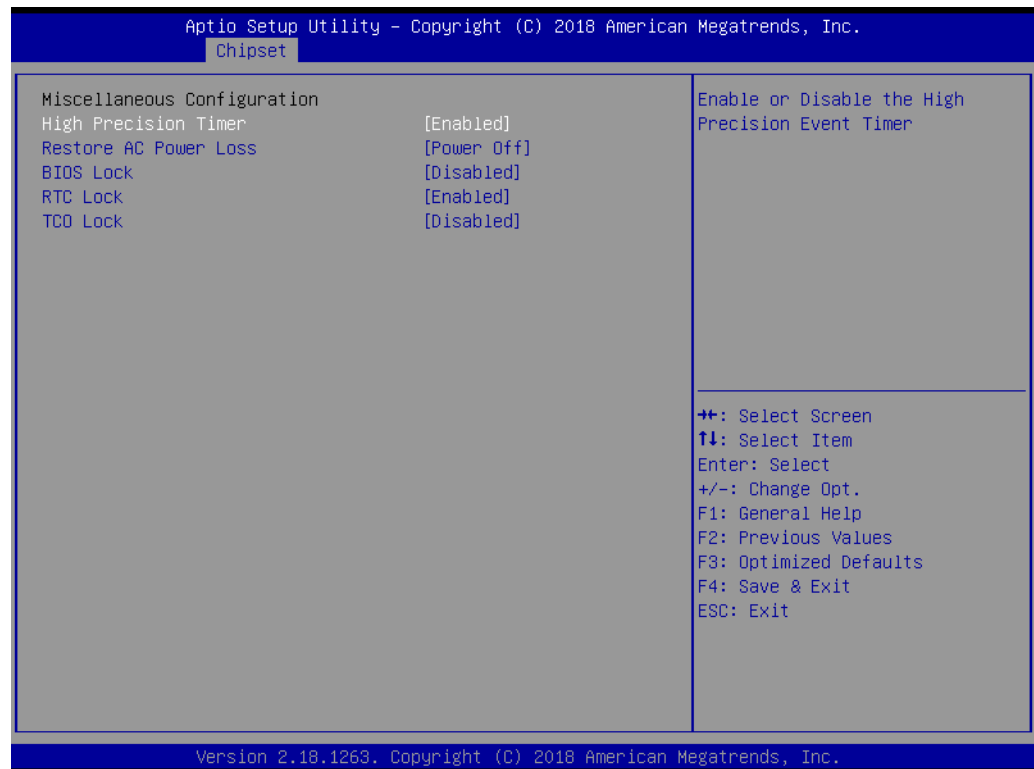

- **High Precision Timer**
Enable or Disable the High Precision Timer.
- **Restore AC Power Loss**
Specify what state to go to when power is re-applied after a power failure (G3 state).
- **BIOS Lock**
Enable/Disable the BIOS Lock Enable feature.
- **RTC Lock**
Enable or disable bytes 38h-3Fh in the upper and lower 128-byte bank of RTC RAM lockdown.
- **TCO SMI Lock**
Enable TCO and Lock Down TCO.

3.1.4 Security

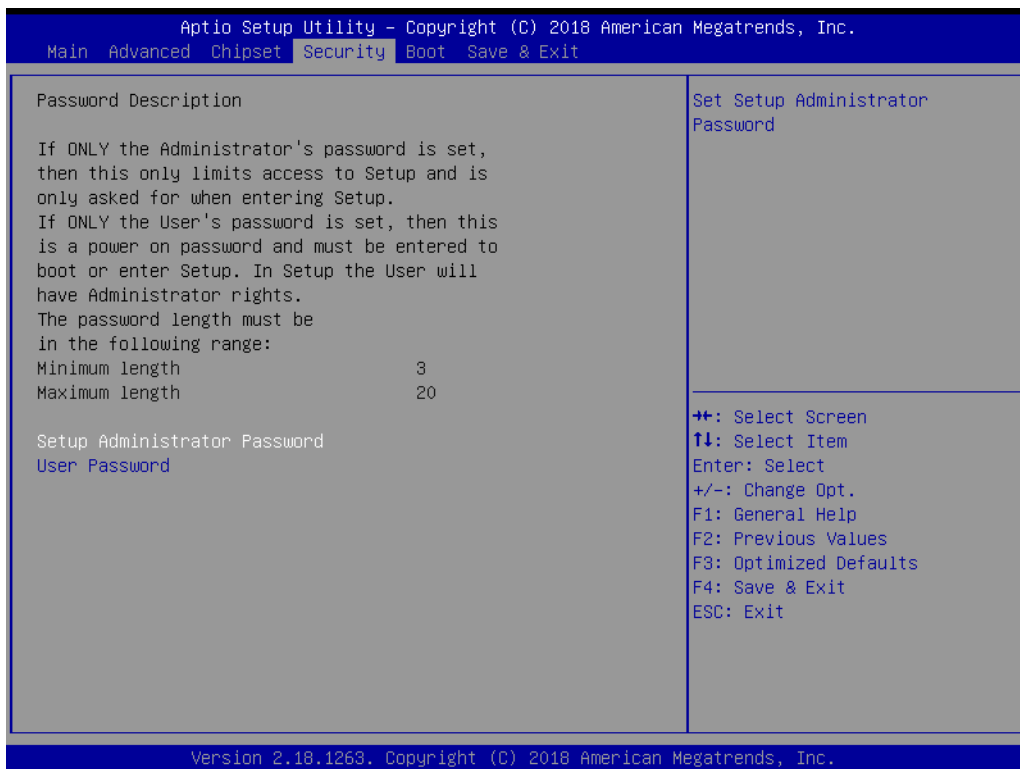

Select Security Setup from the PCM-9366 Setup main BIOS setup menu. All Security Setup options, such as password protection and virus protection are described in this section. To access the sub menu for the following items, select the item and press <Enter>:

- **Change Administrator / User Password**
Select this option and press <ENTER> to access the sub menu, and then type in the password.

3.1.5 Boot

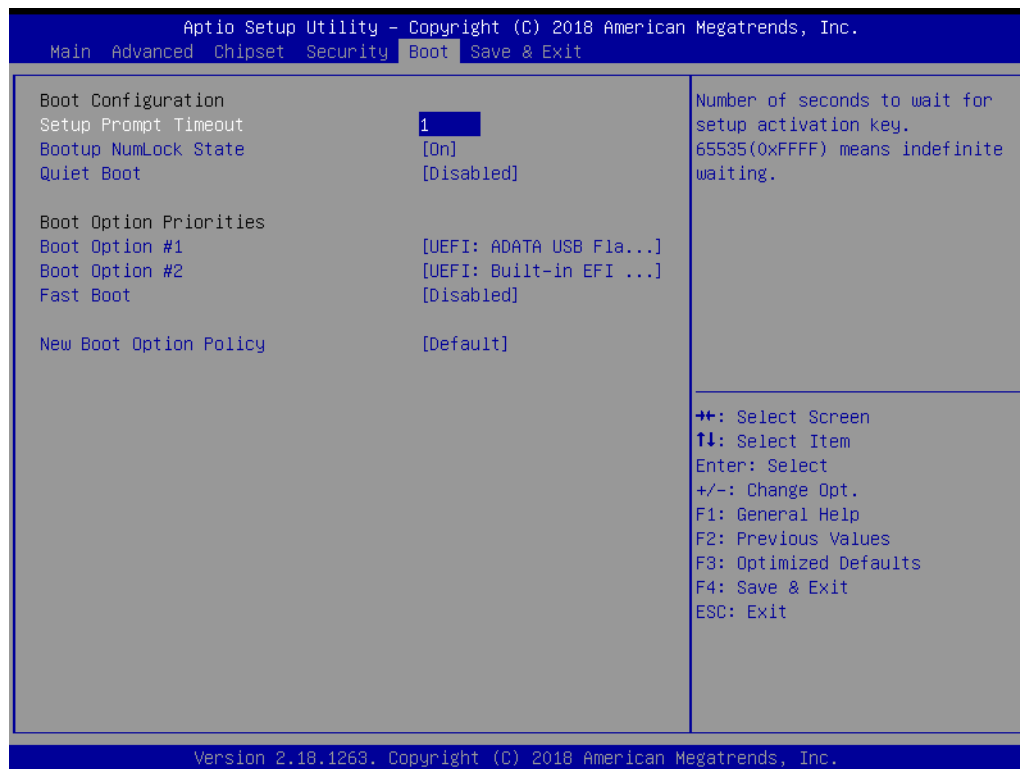

- **Setup Prompt Timeout**
Number of seconds that the firmware will wait before initiating the original default boot selection. A value of 0 indicates that the default boot selection is to be initiated immediately on boot. A value of 65535(0xFFFF) indicates that firmware will wait for user input before booting. This means the default boot selection is not automatically started by the firmware.
- **Bootup NumLock State**
Select the keyboard NumLock state.
- **Quiet Boot**
Enables or disables Quiet Boot option.
- **Boot Option #1**
Sets the system boot order.
- **Fast Boot**
Enables or disables boot with initialization of a minimal set of devices required to launch active boot option. Has no effect for BBS boot options.
- **New Boot Option Policy**
Controls the placement of newly detected UEFI boot options.

3.1.6 Save & Exit

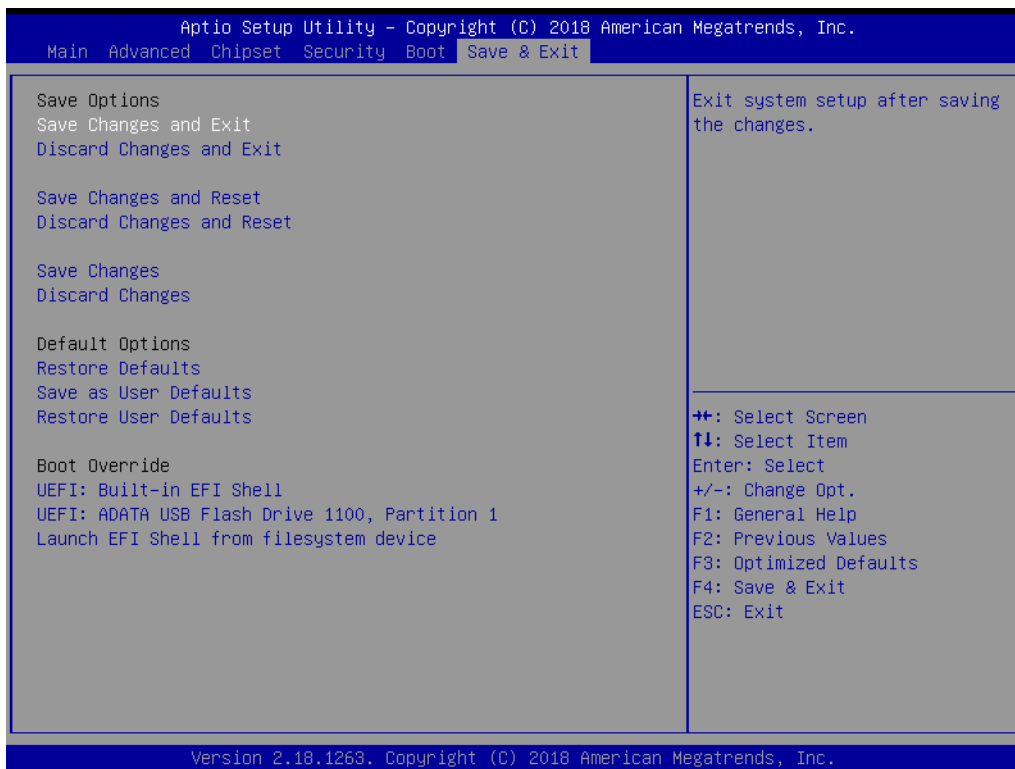

- **Save Changes and Exit**
This item allows you to exit system setup after saving the changes.
- **Discard Changes and Exit**
This item allows you to exit system setup without saving any changes.
- **Save Changes and Reset**
This item allows you to reset the system after saving the changes.
- **Discard Changes and Reset**
This item allows you to rest system setup without saving any changes.
- **Save Changes**
This item allows you to save changes done so far to any of the options.
- **Discard Changes**
This item allows you to discard changes done so far to any of the options.
- **Restore Defaults**
This item allows you to restore/load default values for all the options.
- **Save as User Defaults**
This item allows you to save the changes done so far as user defaults.
- **Restore User Defaults**
This item allows you to restore the user defaults to all the options.
- **Boot Override**
Boot device select can override your boot priority.

Appendix **A**

Pin Assignments

This appendix contains information of a detailed or specialized nature.

Sections include:

- Jumper and Connector Tables

A.1 Jumper List

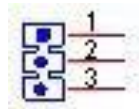

J1	Clear CMOS
Part Number	1653003101
Footprint	HD_3x1P_79_D
Description	PIN HEADER 3x1P 2.0mm 180D(M) DIP 2000-13 WS
Pin	Pin Name
1	RTCRST#
2	GND
3	RTCTSET#
(1-2)*	Normal (default)
(2-3)*	Clear CMOS

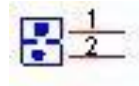

J2	CASE OPEN
Part Number	1653002101-02
Footprint	HD_2x1P_79_D
Description	
Pin	Pin Name
1	RDC_CASEOPEN
2	GND

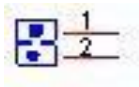

J3	Auto Power On Setting
Part Number	1653002101-02
Footprint	HD_2x1P_79_D
Description	
Setting	Function
NC	Power Button for Power On
(1-2)*	Auto Power On

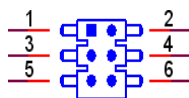

J4	LCD Power
Part Number	1653003260
Footprint	HD_3x2P_79
Description	PIN HEADER 3x2P 2.0mm 180D(M) SMD 21N22050
Setting	Function
(1-3)*	+3.3V
(3-5)	+5V
(3-4)	+12V

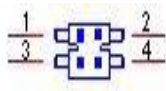

J5	LVDS VCON Setting
Part Number	1653000014
Footprint	HD_2x2P_79
Description	PIN HEADER 2x2P 2.00mm 180D(M) SMD 21N22050
Setting	Function
(1-2)*	3.3V High for VCON on LVDS
(2-3)	Low for VCON on LVDS

A.2 Connector Pin Definition

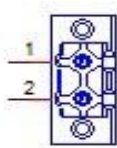

CN1	Power Input
Part Number	1652002724
Footprint	ME060-50002
Description	
Pin	Pin Name
1	GND
2	+VIN

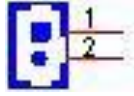

CN3	Battery
Part Number	1655005427-01
Footprint	WF_2P_49_53398-0271
Description	
Pin	Pin Name
1	GND
2	+3V

CN4	SODIMMDDR3_204
Part Number	1651002088
Footprint	SODIMMDDR3_204P_AS0A626-HA
Description	DDR3 SODIMM H=9.2mm 204P SMD AS0A626-HASN-7H
Pin	Pin Name

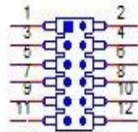

CN5	IS200 Debug Port
Part Number	1653007040-01
Footprint	HD_6X2P_50_21N21040-12M00B
Description	
Pin	Pin Name
1	GND
2	TMS
3	GND
4	TDI
5	GND
6	TDO
7	GND
8	TCK
9	GND
10	GND
11	GND
12	CLK

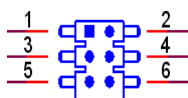

CN6	CAN1/CAN2
Part Number	1653003260
Footprint	HD_3x2P_79
Description	PIN HEADER 3x2P 2.0mm 180D(M) SMD 21N22050
Pin	Pin Name
1	GND
2	GND
3	D1+
4	D2+
5	D1-
6	D2-

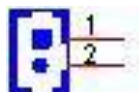

CN8	Power Switch
Part Number	1655302020
Footprint	WF_2P_79_BOX_R1_D
Description	WAFER BOX 2P 2.0mm 180D(M) DIP A2001WV2-2P
Pin	Pin Name
1	PSIN
2	GND

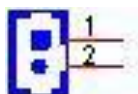

CN9	Reset
Part Number	1655302020
Footprint	WF_2P_79_BOX_R1_D
Description	WAFER BOX 2P 2.0mm 180D(M) DIP A2001WV2-2P
Pin	Pin Name
1	RESET#
2	GND

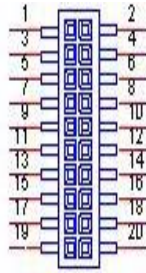

CN10	COM3/COM4/RS422/RS485
Part Number	1653004793
Footprint	HD_10x2P_79_23N685B-20M10
Description	BOX HEADER 10x2P 2.0mm 180D(M)SMD 23N685B-20M10B
Pin	Pin Name
1	422TX3-/485D3-/DCD3#
2	DSR3#
3	422TX3+/485D3+/RXD3
4	RTS3#
5	422RX3+/TXD3
6	CTS3#
7	422RX3-/DTR3#
8	RI3#
9	GND
10	GND
11	422TX4-/485D4-/DCD4#
12	DSR4#
13	422TX4+/485D4+/RXD4
14	RTS4#
15	422RX4+/TXD4
16	CTS4#
17	422RX4-/DTR4#
18	RI4#
19	GND
20	GND

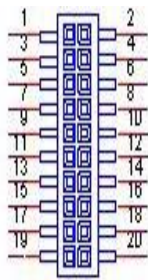

CN11	COM1/COM2
Part Number	1653004793
Footprint	HD_10x2P_79_23N685B-20M10
Description	BOX HEADER 10x2P 2.0mm 180D(M)SMD 23N685B-20M10B
Pin	Pin Name
1	DCD1#
2	DSR1#
3	RXD1
4	RTS1#
5	TXD1
6	CTS1#
7	DTR1#
8	RI1#
9	GND
10	GND
11	DCD2#
12	DSR2#
13	RXD2
14	RTS2#
15	TXD2
16	CTS2#
17	DTR2#
18	RI2#
19	GND
20	GND

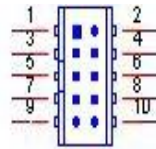

CN12	Audio
Part Number	1653004099
Footprint	HD_5x2P_79_23N685B-10M10
Description	BOX HEADER 5x2P 2.00mm 180D(M) SMD 23N685B-10M10
Pin	Pin Name
1	LOUTR
2	LINR
3	GND
4	GND
5	LOUTL
6	LINL
7	GND
8	GND
9	MIC1R
10	MIC1L

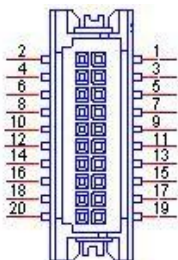

CN13		eDP	
Part Number	1653006914-01		
Footprint	df13-20dp-125v		
Description			
Pin	Pin Name		
1	GND		
2	GND		
3	D0-		
4	D3-		
5	D0+		
6	D3+		
7	GND		
8	NC		
9	D1-		
10	NC		
11	D1+		
12	AUX-		
13	GND		
14	AUX+		
15	D2-		
16	GND		
17	D2+		
18	Hot Plug Detect		
19	+5V or +3.3V		
20	+5V or +3.3V		

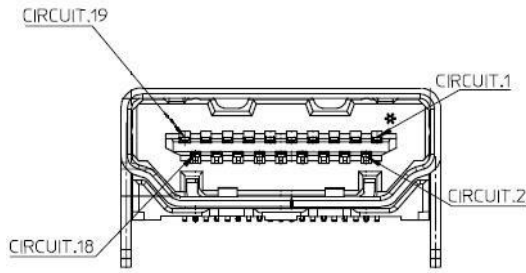

CN14	HDMI
Part Number	1654012807-01
Footprint	HDMI_19P_QJ5119K-HFB4-7F
Description	
Pin	Pin Name
1	TMDS Data2+
2	TMDS Data2 Shield
3	TMDS Data2-
4	TMDS Data1+
5	TMDS Data1 Shield
6	TMDS Data1-
7	TMDS Data0+
8	TMDS Data0 Shield
9	TMDS Data0-
10	TMDS Clock+
11	TMDS Clock Shield
12	TMDS Clock-
13	Reserved
14	Reserved
15	SCL
16	SDA
17	DDC Ground
18	+5V Power
19	Hot Plug Detect

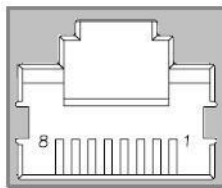

CN16	LAN
Part Number	1652003274
Footprint	RJ45_28P_RTB-19GB9J1A
Description	PHONE JACK RJ45 28P DIP RTB-19GB9J1A
Pin	Pin Name
1	TX+(10/100),BI_DA+(GHz)
2	TX-(10/100),BI_DA-(GHz)
3	RX+(10/100),BI_DB+(GHz)
4	BI_DC+(GHz)
5	BI_DC-(GHz)
6	RX-(10/100),BI_DB-(GHz)
7	BI_DD+(GHz)
8	BI_DD-(GHz)

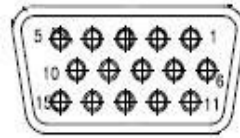

CN18	VGA
Part Number	1654011261-01
Footprint	DBVGA-VF5MS
Description	
Pin	Pin Name
1	RED
2	GREEN
3	BLUE
4	NC
5	GND
6	GND
7	GND
8	GND
9	+5V
10	GND
11	NC
12	DDAT
13	HSYNC
14	VSYNC
15	DCLK

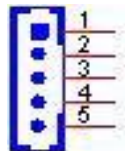

CN19	Inverter Power Output
Part Number	1655000453
Footprint	WHL5V-2M-24W1140
Description	WAFER BOX 2.0mm 5P 180D(M) DIP WO/Pb JIH VEI
Pin	Pin Name
1	+12V
2	GND
3	ENABKL
4	VBR
5	+5V

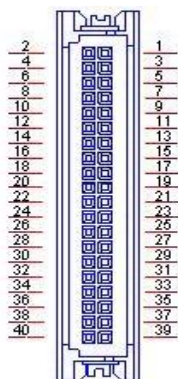

CN20	48-bit LVDS Panel
Part Number	1653006918-01
Footprint	SPH20X2
Description	
Pin	Pin Name
1	+5V or +3.3V
2	+5V or +3.3V
3	GND
4	GND
5	+5V or +3.3V
6	+5V or +3.3V
7	LVDS0_D0-
8	LVDS1_D0-
9	LVDS0_D0+
10	LVDS1_D0+
11	GND
12	GND
13	LVDS0_D1-
14	LVDS1_D1-
15	LVDS0_D1+
16	LVDS1_D1+
17	GND
18	GND
19	LVDS0_D2-
20	LVDS1_D2-
21	LVDS0_D2+
22	LVDS1_D2+
23	GND
24	GND
25	LVDS0_CLK-
26	LVDS1_CLK-

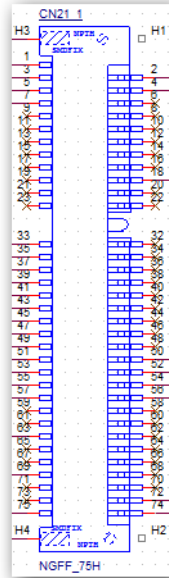

CN21	NGFF CONN
Part Number	1654012663-01
Footprint	NGFF_75P_APCI0163-P001A
Description	
Pin	Pin Name
1	GND
2	+V3.3SB_M.2
3	USB4_P+
4	+V3.3SB_M.2
5	USB4_P-
6	N/A
7	N/A
8	N/A
9	N/A
10	N/A
11	N/A
12	N/A
13	N/A
14	N/A
15	N/A
16	N/A
17	N/A
18	GND
19	N/A
20	N/A -
21	N/A
22	N/A
23	N/A
24	N/A
25	N/A

CN21	NGFF CONN
26	N/A
27	N/A
28	N/A
29	N/A
30	N/A
31	N/A
32	N/A
33	GND
34	N/A
35	PCIE_M2_Z_TX2+
36	N/A
37	PCIE_M2_Z_TX2-
38	N/A
39	GND
40	N/A
41	PCIE_M2_RX2+
42	N/A
43	PCIE_M2_RX2-
44	N/A
45	GND
46	N/A
47	CLK_M2_Z_PCIE+
48	N/A
49	CLK_M2_Z_PCIE-
50	PMU_SUSCLK
51	GND
52	M2_PLTRST#
53	PCIE_A_CLKREQ2#
54	BT_DISABLE#
55	M2_PCIE_WAKE2#
56	WIFI_DISABLE#
57	GND
58	N/A
59	N/A
60	N/A
61	N/A
62	N/A
63	GND
64	N/A
65	N/A
66	N/A
67	N/A
68	N/A
69	GND
70	N/A
71	N/A
72	+V3.3SB_M.2

CN21	NGFF CONN
73	N/A
74	+V3.3SB_M.2
75	GND

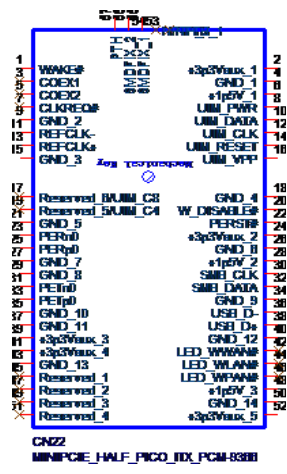

CN22	MINIPCIE_HALF_PICO_ITX_PCM-9366
Part Number	00A00001940
Footprint	MINIPCIE_HALF_PICO_ITX_PCM-9366
Description	
Pin	Pin Name
1	PCIE_MINI_A_WAKE3#
2	+V3.3_MINICARD1
3	NA
4	GND
5	NA
6	+V1.5
7	NA
8	+VUIM_PWR
9	GND
10	UIM_DATA
11	CLK_MINI1_Z_PCIE-
12	UIM_CLK
13	CLK_MINI1_Z_PCIE+
14	UIM_RESET
15	GND
16	+VUIM_VPP
17	NC
18	GND
19	NC
20	WIFI1_Z_DISABLE#
21	GND
22	PM_PLTRST#
23	MSATA_MPCIE_RX-
24	+V3.3_MINICARD1

CN22	MINIPCIE_HALF_PICO_ITX_PCM-9366
25	MSATA_MPCIE_RX+
26	GND
27	GND
28	+V1.5
29	GND
30	SOC_SMB_CLK
31	MSATA_MPCIE_TX-
32	SOC_SMB_DAT
33	MSATA_MPCIE_TX+
34	GND
35	GND
36	USB5_P-
37	GND
38	USB5_P+
39	+V3.3_MINICARD1
40	GND
41	+3p3Vaux_4
42	N/A
43	mSATAH_mPCIE#_a_SEL
44	N/A
45	N/A
46	N/A
47	N/A
48	+V1.5
49	N/A
50	GND
51	N/A
52	+V3.3_MINICARD1

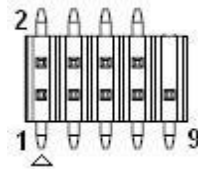

CN23	Internal USB
Part Number	1653005260
Footprint	HD_5x2P_79_N10
Description	PIN HEADER 2x5P 2.0mm 180D(M) SMD 21N22050
Pin	Pin Name
1	+5V
2	+5V
3	A_D-
4	B_D-
5	A_D+
6	B_D+
7	GND
8	GND
9	GND

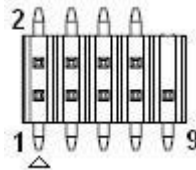

CN24	Internal USB
Part Number	1653005260
Footprint	HD_5x2P_79_N10
Description	PIN HEADER 2x5P 2.0mm 180D(M) SMD 21N22050
Pin	Pin Name
1	+5V
2	+5V
3	A_D-
4	B_D-
5	A_D+
6	B_D+
7	GND
8	GND
9	GND



CN25	External USB3.0
Part Number	1654011725-01
Footprint	USB_9x2P_WDU3R-18F3B4PBUW3
Description	
Pin	Pin Name
1	+5V
2	D-
3	D+
4	GND
5	SSRX-
6	SSRX+
7	GND
8	SSTX-
9	SSTX+
10	+5V
11	D-
12	D+
13	GND
14	B_SSRX-
15	B_SSRX+
16	GND
17	B_SSTX-
18	B_SSTX+

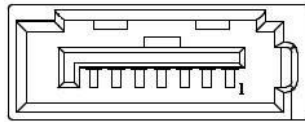

CN26	SATA
Part Number	1654011616-01
Footprint	SATA_7P_WATF-07DBN6SB1U
Description	Serial ATA 7P 1.27mm 180D(M) SMDWATF-07DBLSB1UW
Pin	Pin Name
1	GND
2	TX+
3	TX-
4	GND
5	RX-
6	RX+
7	GND

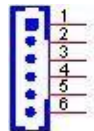

CN27	HDD & PWR LED
Part Number	1655306020-01
Footprint	WF_6P_79_BOX_D_721-81-06TW00
Description	
Pin	Pin Name
1	+5V
2	GND
3	Power LED+(5V)
4	GND
5	Power LED+(3V)
6	SATA LED

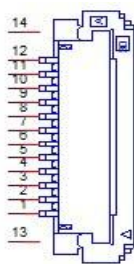

CN28	LPC Debug Port
Part Number	1654011013-01
Footprint	FPC_12P_20_04-6239
Description	
Pin	Pin Name
1	NC
2	NC
3	NC
4	GND
5	+3.3V
6	RESET#
7	CLK
8	AD0
9	AD1
10	AD2
11	AD3
12	FRAME#

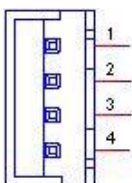

CN29	SATA Power
Part Number	1655001154
Footprint	WF_4P_98_BOX_R1_D
Description	WAFER BOX 4P 2.50mm 180D(M) DIP 24W1170-04S10-01
Pin	Pin Name
1	+5V
2	GND
3	GND
4	+12V

\

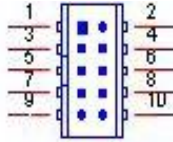

CN30	GPIO
Part Number	1653004099
Footprint	HD_5x2P_79_23N685B-10M10
Description	BOX HEADER 5x2P 2.00mm 180D(M) SMD 23N685B-10M10
Pin	Pin Name
1	+5V
2	GPIO12
3	GPIO8
4	GPIO13
5	GPIO9
6	GPIO14
7	GPIO10
8	GPIO15
9	GPIO11
10	GND

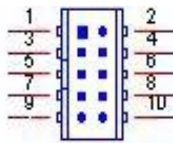

CN31	GPIO
Part Number	1653004099
Footprint	HD_5x2P_79_23N685B-10M10
Description	BOX HEADER 5x2P 2.00mm 180D(M) SMD 23N685B-10M10
Pin	Pin Name
1	+5V
2	GPIO4
3	GPIO0
4	GPIO5
5	GPIO1
6	GPIO6
7	GPIO2
8	GPIO7
9	GPIO3
10	GND

GPIO spec.			
GPIO Pin	Output/Input	Low/High	Open Drain/Push Pull
0	Input	Low	Open Drain
1	Input	Low	Open Drain
2	Input	Low	Open Drain
3	Input	Low	Open Drain
4	Input	Low	Open Drain
5	Input	Low	Open Drain
6	Input	Low	Open Drain
7	Input	Low	Open Drain
8	Input	Low	Open Drain
9	Input	Low	Open Drain
10	Input	Low	Open Drain
11	Input	Low	Open Drain
12	Input	Low	Open Drain
13	Input	Low	Open Drain
14	Input	Low	Open Drain
15	Input	Low	Open Drain

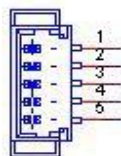

CN32	SMBus
Part Number	1655004032
Footprint	WF_5P_49_BOX_85205
Description	WAFER 5P 1.25mm 180D(M) SMD 85205-05701
Pin	Pin Name
1	GND
2	SMB_ALERT#
3	SMB_DAT
4	SMB_CLK
5	+5V

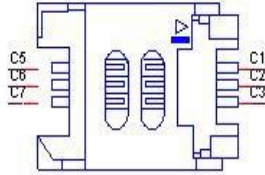

CN33	SIM
Part Number	1654010809-01
Footprint	SIM_6P_5210622-SINR03
Description	SIM card conn. 6p 2.54mm 90D(F) SMD 5210622-SINR
Pin	Pin Name
C1	UIM_PWR
C2	UIM_RESET
C3	UIM_CLK
C5	GND
C6	UIM_VPP
C7	UIM_DATA



SW1	DIP SW
Part Number	1600003260-01
Footprint	SW_2x2P_100_198x378
Description	DIP SW ESD102LT61Z SMD 2x2P 5.08X6.6mm
Pin	Pin Name
1	mSATAH_mPCIE#_SEL
2	mSATAH_mPCIE#_SEL
3	GND
4	mSATAH_mPCIE#_a_SEL

Appendix **B**

System Assignments

This appendix contains information of a detailed nature.

Sections include:

- System I/O Ports
- 1st MB Memory Map
- Interrupt Assignments

B.1 System I/O Ports

Table B.1: System I/O Ports

Addr. Range (Hex)	Device
20–2D	Interrupt Controller
2E – 2F	Motherboard resources
30 – 3D	Interrupt Controller
40 – 43	System timer
4E – 4F	Motherboard resources
50 – 53	System timer
61 – 67	Motherboard resources
70 - 77	System CMOS/real time clock
80 - 92	Motherboard resources
A0 – B1	Interrupt Controller
B2 – B3	Motherboard resources
B4 – BD	Interrupt Controller
272 – 273	Motherboard resources
290 – 29F	Embedded Controller resources
2E8 – 2EF	COM4
2F8 – 2FF	COM2
3B0 – 3DF	Intel® HD Graphics
3E8 – 3EF	COM3
3F8 – 3FF	COM1
400 – 47F	Motherboard resources
4D0 – 4D1	Interrupt Controller
500 – 57F	Motherboard resources

B.2 1st MB Memory Map

Table B.2: 1st MB Memory Map

Addr. Range (Hex)	Device
A0000h - BFFFFh	Intel® HD Graphics
A0000h - BFFFFh	PCI Bus
C0000h - DFFFFh	PCI Bus
E0000h - FFFFFh	PCI Bus
D0400000 – D05FFFFFFF	Intel® Trusted Execution Engine Interface
E0000000 - FEFFFFFFF	System resources

B.3 Interrupt Assignments

Table B.3: Interrupt assignments

Interrupt#	Interrupt source
NMI	Parity error detected
IRQ0	System timer
IRQ1	Using SERIRQ, Keyboard Emulation
IRQ2	Slave controller INTR output
IRQ3	Communications Port (COM2)
IRQ4	Communications Port (COM1)
IRQ5	Available
IRQ6	Available
IRQ7	Communications Port (COM3) / iManager WatchDog IRQ
IRQ8	Internal RTC or HPET
IRQ9	Microsoft ACPI-Compliant System
IRQ10	Available
IRQ11	Communications Port (COM4)
IRQ12	Available
IRQ13	Numeric data processor
IRQ14	SATA controller
IRQ15	SATA controller

ADVANTECH

Enabling an Intelligent Planet

www.advantech.com

Please verify specifications before quoting. This guide is intended for reference purposes only.

All product specifications are subject to change without notice.

No part of this publication may be reproduced in any form or by any means, electronic, photocopying, recording or otherwise, without prior written permission of the publisher.

All brand and product names are trademarks or registered trademarks of their respective companies.

© Advantech Co., Ltd. 2018

Appendix **D**

EC Watchdog Timer
Sample Code

D.1 EC Watchdog Timer sample code

EC_Command_Port = 0x29Ah

EC_Data_Port = 0x299h

Write EC HW ram = 0x89

Watch dog event flag = 0x57

Watchdog reset delay time = 0x5E

Reset event = 0x04

Start WDT function = 0x28

=====

.model small

.486p

.stack 256

.data

.code

org 100h

.STARTup

mov dx, EC_Command_Port

mov al,89h ;Write EC HW ram.

out dx,al

mov dx, EC_Data_Port

mov al, 5Fh ;Watchdog reset delay time low byte (5Eh is high byte) index.

out dx,al

mov dx, EC_Data_Port

mov al, 30h ;Set 3 seconds delay time.

out dx,al

mov dx, EC_Command_Port

mov al,89h ;Write EC HW ram.

out dx,al

mov dx, EC_Data_Port

mov al, 57h ;Watch dog event flag.

out dx,al

mov dx, EC_Data_Port

mov al, 04h ;Reset event.

out dx,al

mov dx, EC_Command_Port

mov al,28h ;Start WDT function.

out dx,al

.exit

END

Our company network supports you worldwide with offices in Germany, Austria, Switzerland, the UK and the USA. For more information please contact:

Headquarters

Germany



FORTEC Elektronik AG

Augsburger Str. 2b
82110 Germering

Phone: +49 89 894450-0
E-Mail: info@fortecag.de
Internet: www.fortecag.de

Fortec Group Members

Austria



Distec GmbH Office Vienna

Nuschinggasse 12
1230 Wien

Phone: +43 1 8673492-0
E-Mail: info@distec.de
Internet: www.distec.de

Germany



Distec GmbH

Augsburger Str. 2b
82110 Germering

Phone: +49 89 894363-0
E-Mail: info@distec.de
Internet: www.distec.de

Switzerland



ALTRAC AG

Bahnhofstraße 3
5436 Würenlos

Phone: +41 44 7446111
E-Mail: info@altrac.ch
Internet: www.altrac.ch

United Kingdom



Display Technology Ltd.

Osprey House, 1 Osprey Court
Hichingbrooke Business Park
Huntingdon, Cambridgeshire, PE29 6FN

Phone: +44 1480 411600
E-Mail: info@displaytechnology.co.uk
Internet: www.displaytechnology.co.uk

USA



Apollo Display Technologies, Corp.

87 Raynor Avenue,
Unit 1 Ronkonkoma,
NY 11779

Phone: +1 631 5804360
E-Mail: info@apolloDisplays.com
Internet: www.apolloDisplays.com