



OUR GLOBAL
COMPETENCE
CENTRES

 APOLLO DISPLAY
TECHNOLOGIES



 DISTEC



 DISPLAY
TECHNOLOGY



Manual

congatec

conga-JC370

3,5" Single-Board Computer with 8th Generation Intel® Core™ i or Intel® Celeron® Low Power U-Series

Processors



The information contained in this document has been carefully researched and is, to the best of our knowledge, accurate. However, we assume no liability for any product failures or damages, immediate or consequential, resulting from the use of the information provided herein. Our products are not intended for use in systems in which failures of product could result in personal injury. All trademarks mentioned herein are property of their respective owners. All specifications are subject to change without notice.

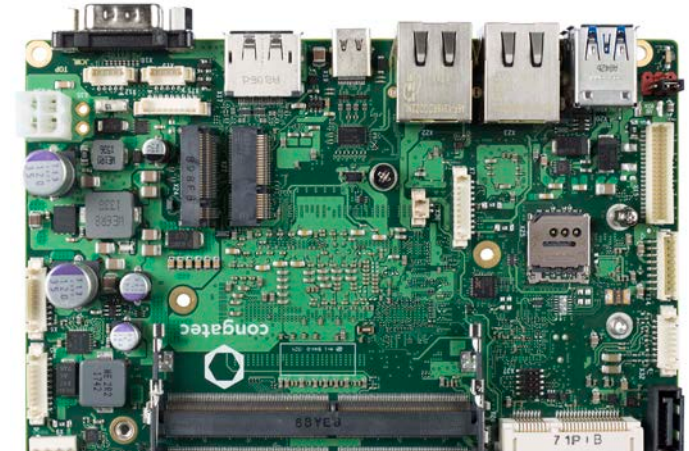

conga-JC370 Juke SBC

8th Generation Intel Core i7, i5, i3 and Celeron Single Chip Ultra Low TDP U-Series SoC

User's Guide

Revision 1.0

Revision History

Revision	Date (yyyy-mm-dd)	Author	Changes
0.1	2019-11-19	AEM	<ul style="list-style-type: none">• Preliminary release
0.2	2020-02-06	AEM	<ul style="list-style-type: none">• Updated the ethernet description and Intel AMT version in section 2.1 "Feature List"• Added note about TSN support to section 5.6 "Ethernet"• Corrected the signal name of pins 69 and 71 in section 5.2.4 "M.2 Key M Socket"• Updated table 8 "Power Consumption Values"• Added BIOS MLF information to 7 "BIOS Setup Description"• Deleted section 8 "Industry Specifications"• Official release

Preface

This user's guide provides information about the components, features and connectors available on the conga-JC370 Juke single board computer.

Disclaimer

The information contained within this user's guide, including but not limited to any product specification, is subject to change without notice.

congatec AG provides no warranty with regard to this user's guide or any other information contained herein and hereby expressly disclaims any implied warranties of merchantability or fitness for any particular purpose with regard to any of the foregoing. congatec AG assumes no liability for any damages incurred directly or indirectly from any technical or typographical errors or omissions contained herein or for discrepancies between the product and the user's guide. In no event shall congatec AG be liable for any incidental, consequential, special, or exemplary damages, whether based on tort, contract or otherwise, arising out of or in connection with this user's guide or any other information contained herein or the use thereof.

Intended Audience

This user's guide is intended for technically qualified personnel. It is not intended for general audiences.

Lead-Free Designs (RoHS)

All congatec AG products are created from lead-free components and are completely RoHS compliant.

Electrostatic Sensitive Device



All congatec AG products are electrostatic sensitive devices. They are enclosed in static shielding bags, and shipped enclosed in secondary packaging (protective packaging). The secondary packaging does not provide electrostatic protection.

Do not remove the device from the static shielding bag or handle it, except at an electrostatic-free workstation. Also, do not ship or store electronic devices near strong electrostatic, electromagnetic, magnetic, or radioactive fields unless the device is contained within its original packaging. Be aware that failure to comply with these guidelines will void the congatec AG Limited Warranty.

Symbols

The following symbols are used in this user's guide:



Warning

Warnings indicate conditions that, if not observed, can cause personal injury.



Caution

Cautions warn the user about how to prevent damage to hardware or loss of data.



Note

Notes call attention to important information that should be observed.



Connector Type

Describes the connector used on the Single Board Computer.

Copyright Notice

Copyright © 2019, congatec AG. All rights reserved. All text, pictures and graphics are protected by copyrights. No copying is permitted without written permission from congatec AG.

congatec AG has made every attempt to ensure that the information in this document is accurate yet the information contained within is supplied "as-is".

Trademarks

Product names, logos, brands, and other trademarks featured or referred to within this user's guide, or the congatec website, are the property of their respective trademark holders. These trademark holders are not affiliated with congatec AG, our products, or our website.

Warranty

congatec AG makes no representation, warranty or guaranty, express or implied regarding the products except its standard form of limited warranty ("Limited Warranty") per the terms and conditions of the congatec entity, which the product is delivered from. These terms and conditions can be downloaded from www.congatec.com. congatec AG may in its sole discretion modify its Limited Warranty at any time and from time to time.

The products may include software. Use of the software is subject to the terms and conditions set out in the respective owner's license agreements, which are available at www.congatec.com and/or upon request.

Beginning on the date of shipment to its direct customer and continuing for the published warranty period, congatec AG represents that the products are new and warrants that each product failing to function properly under normal use, due to a defect in materials or workmanship or due to non conformance to the agreed upon specifications, will be repaired or exchanged, at congatec's option and expense.

Customer will obtain a Return Material Authorization ("RMA") number from congatec AG prior to returning the non conforming product freight prepaid. congatec AG will pay for transporting the repaired or exchanged product to the customer.

Repaired, replaced or exchanged product will be warranted for the repair warranty period in effect as of the date the repaired, exchanged or replaced product is shipped by congatec, or the remainder of the original warranty, whichever is longer. This Limited Warranty extends to congatec's direct customer only and is not assignable or transferable.

Except as set forth in writing in the Limited Warranty, congatec makes no performance representations, warranties, or guarantees, either express or implied, oral or written, with respect to the products, including without limitation any implied warranty (a) of merchantability, (b) of fitness for a particular purpose, or (c) arising from course of performance, course of dealing, or usage of trade.

congatec AG shall in no event be liable to the end user for collateral or consequential damages of any kind. congatec shall not otherwise be liable for loss, damage or expense directly or indirectly arising from the use of the product or from any other cause. The sole and exclusive remedy against congatec, whether a claim sound in contract, warranty, tort or any other legal theory, shall be repair or replacement of the product only.

Certification



congatec AG is certified to DIN EN ISO 9001 standard.



Technical Support

congatec AG technicians and engineers are committed to providing the best possible technical support for our customers so that our products can be easily used and implemented. We request that you first visit our website at www.congatec.com for the latest documentation, utilities and drivers, which have been made available to assist you. If you still require assistance after visiting our website then contact our technical support department by email at support@congatec.com

Terminology

Term	Description
PCIe	Peripheral Component Interface Express
cBC	congatec Board Controller
SDIO	Secure Digital Input Output
USB	Universal Serial Bus
SATA	Serial AT Attachment
HDA	High Definition Audio
S/PDIF	Sony/Philips Digital Interconnect Format
HDMI	High Definition Multimedia Interface
DVI	Digital Visual Interface
PTT	Platform Trust Technology
LPC	Low Pin-Count
iDP	Internal DisplayPort
I ² C Bus	Inter-Integrated Circuit Bus
SM Bus	System Management Bus
SPI	Serial Peripheral Interface
GbE	Gigabit Ethernet
LVDS	Low-Voltage Differential Signaling
SBC	Single Board Computer
PN	Part Number
N.C	Not connected
N.A	Not available
T.B.D	To be determined

Contents

1	Introduction	10	5.3	Display Interfaces.....	33
1.1	The 3.5" SBC Concept	10	5.3.1	Display Port.....	33
1.2	conga-JC370.....	10	5.3.2	USB Type-C Alternate Mode.....	33
1.2.1	Options Information.....	11	5.3.3	LVDS/eDP Header.....	34
1.2.2	Optional Accessories	11	5.3.3.1	Panel Voltage Selection Jumper.....	35
2	Specification	13	5.3.3.2	Backlight Control Voltage Selection Jumper.....	36
2.1	Feature List	13	5.3.3.3	Backlight Power Header	36
2.2	Supported Operating Systems	14	5.4	USB Connectors.....	37
2.3	Mechanical Dimensions	14	5.4.1	USB 3.1 Gen. 2 Port.....	37
2.4	Supply Voltage Power.....	15	5.4.2	USB 2.0 Header	37
2.5	Power Consumption	15	5.4.3	USB Type-C Port	38
2.6	Supply Voltage Battery Power	16	5.5	SATA Connectors	38
2.7	Environmental Specifications.....	17	5.5.1	Standard SATA Port	38
3	Block Diagram.....	18	5.5.2	mSATA Socket.....	39
4	Cooling Solution	19	5.5.3	M.2 Key M Socket.....	39
4.1	CSA Dimensions	20	5.5.4	SATA Power Header.....	39
4.2	CSP Dimensions.....	21	5.6	Ethernet	40
4.3	HSP Dimensions.....	22	5.7	HDA Header	40
5	Connector Description.....	23	5.8	COM Port Headers	42
5.1	Power Supply Connectors.....	23	5.8.1	COM Port 1 and 2 Connectors	42
5.1.1	Mini-Fit 4-Pin Connector.....	23	5.8.2	COM Port 3 and 4 Headers	43
5.1.2	USB Type-C Port	24	5.9	GPIO Header	44
5.1.3	Power Status LEDs	24	5.10	System Management Header	44
5.1.4	Power-On Control Jumper.....	24	5.11	I ² C Bus/SM Bus Header	45
5.1.5	CMOS Battery Header.....	25	5.12	Front Panel Header.....	46
5.2	Extension Sockets	26	5.12.1	CPU Fan Header	47
5.2.1	Mini Card Socket.....	26	6	Additional Features.....	48
5.2.2	M.2 Key B Socket.....	27	6.1	Micro-SIM Card.....	48
5.2.3	M.2 Key E Socket.....	29	6.2	Case-open Intrusion Connector.....	49
5.2.4	M.2 Key M Socket.....	30	6.3	External BIOS Flash	49
5.2.5	PCI Express Routing.....	32	6.4	congatec Board Controller (cBC)	50
			6.4.1	Fan Control	50
			6.4.2	Power Loss Control	50
			6.4.3	Board Information.....	50

6.5	OEM BIOS Customization.....	50	6.9	Security Features.....	53
6.5.1	OEM Default Settings.....	50	6.10	External System Wake Event	53
6.5.2	OEM Boot Logo.....	51	7	BIOS Setup Description	54
6.5.3	OEM POST Logo	51	7.1	Navigating the BIOS Setup Menu	54
6.5.4	OEM BIOS Code/Data.....	51	7.2	BIOS Versions.....	54
6.5.5	OEM DXE Driver	51	7.3	Updating the BIOS.....	55
6.6	congatec Battery Management Interface	52	7.4	Supported Flash Devices	55
6.7	API Support (CGOS)	52			
6.8	Thermal and Voltage Monitoring.....	52			

List of Tables

Table 1	conga-JC370 Variants	11	Table 37	X3 Pinout Description	49
Table 2	Cooling	11	Table 38	X37 Pinout Description	49
Table 3	Cables	12			
Table 4	Adapters	12			
Table 5	Power Supply	12			
Table 6	Feature Summary	13			
Table 7	Measurement Description.....	15			
Table 8	Power Consumption Values	16			
Table 9	CMOS Battery Power Consumption	16			
Table 10	Cooling Solution Variants.....	19			
Table 11	Connector X34 Pinout Description	23			
Table 12	D57 LED States	24			
Table 13	Auto Power-On Control	24			
Table 14	X36 Pin Header	25			
Table 15	X26 Pinout Description	26			
Table 16	X24 Pinout Description	27			
Table 17	X27 Pinout Description	29			
Table 18	X28 Pinout Description	30			
Table 19	Connector X15 Pinout Description	34			
Table 20	JP1 Pinout Description.....	35			
Table 21	JP3 Pinout Description.....	36			
Table 22	Connector X14 Pinout Description	36			
Table 23	Connector X21 Pinout Description	37			
Table 24	X30 Pinout Description	39			
Table 25	GbE LED Description	40			
Table 26	X31 Pinout Description	40			
Table 27	X32 Pinout Description	41			
Table 28	X11 Pinout Description	42			
Table 29	X10 Pinout Description	42			
Table 30	X12/X13 Pinout Description	43			
Table 31	X5 Pinout Description	44			
Table 32	X6 Pinout Description	44			
Table 33	X7 Pinout Description	45			
Table 34	X4 Pinout Description	46			
Table 35	X9 Pinout Description	47			
Table 36	X25 Pinout Description	48			

1 Introduction

1.1 The 3.5" SBC Concept

The 3.5" SBC provides enthusiasts and manufacturers with a standardized ultra compact platform for development. With a footprint of 146 mm x 102 mm, this scalable platform promotes the design of highly integrated, energy efficient systems. Due to its small size, the 3.5" SBC form factor enables PC appliance designers not only to design attractive low cost devices but also allows them to explore a huge variety of product development options—from compact space-saving designs to fully functional Information Station and Value PC systems. This helps to reduce product design cycle and encourages rapid innovation in system design, to meet the ever-changing needs of the market.

Additionally, the boards can also be passively cooled, presenting opportunities for fanless designs. The 3.5" SBC boards are equipped with various interfaces such as PCI Express, SATA, USB 2.0/3.0, Ethernet, Displays and Audio.

1.2 conga-JC370

The conga-JC370 is a Single Board Computer with 3.5" form factor. The conga-JC370 features the 8th Generation Intel Core UE-Series processors. With 15 W base TDP, the SBC offers Ultra Low Power boards with high computing performance and outstanding graphics. Additionally, the SBC supports dual channel DDR4 up to 2400 MT/s for a maximum system memory capacity of 64 GB, multiple I/O interfaces, up to three independent displays and various congatec embedded features.

With smaller board size and lower height keep-out zones, the conga-JC370 SBC provides manufacturers and system designers with the opportunity to design compact systems for space restricted areas.

The various features and capabilities offered by the conga-JC370 makes it ideal for the design of compact, energy efficient, performance-oriented embedded systems.

1.2.1 Options Information

The conga-JC370 is currently available in four variants. The table below show the different configurations available.

Table 1 conga-JC370 Variants

Part-No.	054001	054002	054003	054005
Processor	Intel® Core™ i7-8665UE 1.7 GHz Quad Core™	Intel® Core™ i5-8365UE 1.6 GHz Quad Core™	Intel® Core™ i3-8145UE 2.2 GHz Dual Core™	Intel® Celeron® 4305UE 2.0 GHz Dual Core
Intel® Smart Cache	8 MB	6 MB	4 MB	2 MB
Max. Turbo Frequency	4.4 GHz	4.1 GHz	3.9 GHz	N.A
Processor Graphics	Intel® UHD Graphics 620 (GT2)	Intel® UHD Graphics 620 (GT2)	Intel® UHD Graphics 620 (GT2)	Intel® UHD Graphics 610 (GT1)
GFX Base/Max. Dynamic Freq.	0.3 / 1.15 GHz	0.3 / 1.05 GHz	0.3 / 1.0 GHz	0.3 / 1.0 GHz
DDR4 Memory	2400 MT/s dual channel Non-ECC (up to 64 GB)	2400 MT/s dual channel Non-ECC (up to 64 GB)	2400 MT/s dual channel Non-ECC (up to 64 GB)	2133 MT/s dual channel Non-ECC (up to 64 GB)
USB Type-C	USB/DP	USB/DP	USB/DP	USB/DP
LVDS	Yes	Yes	Yes	Yes
DisplayPort	DP++	DP++	DP++	DP++
Processor TDP (cTDP)	15 W (12.5/25 W)	15 W (12.5/25 W)	15 W (12.5/25 W)	15 W (12.5 W)

1.2.2 Optional Accessories

Table 2 Cooling

Accessories	Part No.	Description
conga-JC370/CSA-B	054050	12 V active cooling solution with bore-hole standoffs
conga-JC370/CSA-T	054051	12 V active cooling solution with threaded standoffs
conga-JC370/CSP-B	054052	Passive cooling solution with bore-hole standoffs
conga-JC370/CSP-T	054053	Passive cooling solution with threaded standoffs
conga-JC370/HSP-B	054054	Heatspreader with bore-hole standoffs
conga-JC370/HSP-T	054055	Heatspreader with threaded standoffs

Table 3 Cables

Cables	Part No.	Description
cab-MITX-eDP 1-1	14000129	40-pin ACES eDP cable (to be combined with PNs: 052231, 052232 and 052234)
cab-Pico-ITX-Buttons-LED	14000147	15 cm internal buttons and LEDs cable
cab-Pico-ITX-GPIO	14000151	15 cm GPIO cable with open end
cab-Pico-ITX-RS232	14000152	15 cm 5-wire RS232 cable adapter (DSUB9 male)
cab-Pico-ITX-SATA-Power	14000205	15 cm SATA power cable for 2.5" HDD only (+5V only)
cab-Pico-ITX-USB20-Twin	14000210	20 cm USB cable adapter with 2x5 pin, 2 mm pitch female header and two USB Type-A receptacle
cab-DSUB9M-PB9	14000252	15 cm male DSUB9 to 9-pin picoblade cable adapter
cab-Backlight ZHR-8	14000253	50 cm backlight cable with ZHR-8 connector and open end
cab-LVDS SHDR-40V	14000254	50 cm, 40-pin LVDS cable with JST SHDR-40 connector and open end
cab-Backlight ZHR-8	14000255	50 cm backlight cable with ZHR-8 connector and open end
cab-LVDS SHDR-40V FI-X30HL	14000256	50 cm, 40-pin LVDS cable with JST SHDR-40 and JAE FI-X30HL connectors
SATA III cable	48000029	30 cm SATA III cable with straight-straight connectors

Table 4 Adapters

Adapters	Part No.	Description
conga-Thin MITX/eDP to DP adapter	052231	eDP to standard DP adapter for variants with iDP
conga-Thin MITX/eDP to HDMI adapter	052232	eDP to standard HDMI adapter for variants with iDP
conga-eDP to LVDS Adapter	052234	eDP to LVDS adapter for variants with iDP

Table 5 Power Supply

PSU	Part No.	Description
Power supply (90 W, 19 V @ 4.74 A)	10000146	FSP090-DIEBN2, Plug 7.4 x 5.1 x 12.5 mm
Power cable adapter	14000266	7.4 x 5 mm female connector to MiniFIT 2 x 2 connector

2 Specification

2.1 Feature List

Table 6 Feature Summary

Form Factor	Based on 3.5" form factor (146 x 102 mm)	
Processor	8 th Generation Intel® Core™ i7,i5, i3 and Celeron Single Chip Ultra Low TDP Processors	
Memory	Two memory sockets (located on the top side of the conga-JC370). Supports <ul style="list-style-type: none"> - SO-DIMM non-ECC DDR4 modules - Data rates up to 2400 MT/s - Maximum 64 GB capacity (32 GB each) 	
congatec Board Controller	Multi-stage watchdog, non-volatile user data storage, manufacturing and board information, board statistics, hardware monitoring, fan control, I2C bus, Power loss control	
Chipset	Intel® 300 Series PCH-LP integrated in the Multi-Chip Package	
Audio	Realtek ALC888S-VD High Definition Audio	
Ethernet	2x Gigabit Ethernet via: <ul style="list-style-type: none"> - Intel® I219-LM for i7 and i5 variants (supports vPro/AMT) or I219-V for i3 and Celeron variants - Intel® I225-LM (with support for TSN) or Intel I255-V (without TSN) 	
Graphic Interfaces	1x DP++ 1x LVDS/eDP 1x USB Type-C (DP)	
Back Panel I/O Connectors	1x DisplayPort++ 1x USB Type C (alternate mode)	2x USB 3.1 Gen 2 2x Gigabit Ethernet 1x COM port (COM1)
Onboard I/O Connectors	Extension Sockets: <ul style="list-style-type: none"> - 1x M.2 key B, type 3042/2242 (PCIe x2/USB/SIM) - 1x M.2 key E, type 2230 (PCIe x1/USB/CNVi) - 1x M.2 key M, type 2280 (PCIe x4/SATA/Intel® Optane™) - 1x Mini Card full-size or half-size (PCIe x1/SATA/USB) SATA Connectors: <ul style="list-style-type: none"> - 1x Standard SATA 3.0/eSATA/SATADOM - 1x SATA power header (5 V) Audio <ul style="list-style-type: none"> - 1x Front panel header (HP-Out, MIC) - 1x Internal audio header (Line-Out, DMIC) 	1x LVDS connector (top-side) 1x Backlight power connector 1x Micro-SIM card slot 1x COM port (COM2) 1x Mini-FIT power connector 1x Dual USB 2.0 header 1x Intrusion detection header (case open) 2x COM ports (COM3 and COM4) 1x CPU fan header (12 V only) 1x Front panel header (power button, reset,sleep, LEDs) 1x GPIO header (GPIO 0–7) 1x SMB/I2C connector
Optional Onboard Interfaces	1x CAN header 1x HDMI (DP is not supported with this option) 1x GPIO header (GPIO 8-15 with System Management overlay) 1x iDP header (this option does not support DP on USB Type-C) 1x eDP (with LVDS overlay)	

Other Features	Thermal and voltage monitoring CMOS Battery congatec standard BIOS (also possible to boot from an external BIOS flash)
BIOS	AMI Aptio® V UEFI 2.6 firmware 32 MB serial SPI flash with congatec Embedded BIOS features
Power Management	ACPI 4.0 compliant with battery support. Also supports Suspend to RAM (S3) and Intel AMT 11. Configurable TDP Ultra low standby power consumption, deep sleep.
Security	Firmware TPM 2.0 (Intel PTT) Discrete TPM 2.0 (Infineon SLB9670)

2.2 Supported Operating Systems

The conga-JC370 supports the following operating systems.

- Microsoft® Windows® 10
- Microsoft® Windows® 10 IoT Enterprise
- Linux 3.x/4.x
- Yocto
- Real Time Systems Hypervisor



Note
The Intel® Whisky Lake SoC supports only 64-bit operating systems.

2.3 Mechanical Dimensions

- 146 mm x 102 mm
- 20 mm height (15 mm top-side, 5 mm bottom-side)

2.4 Supply Voltage Power

- 12–24V DC \pm 5 %

2.5 Power Consumption

The power consumption values were measured using the following test setup:

- Input voltage +12V
- conga-JC370 SBC
- conga-JC370 CSA
- Microsoft Windows 10 (64 bit)



Note

The CPU was stressed to its maximum workload with the Intel® Thermal Analysis Tool.

Table 7 Measurement Description

The power consumption values were recorded during the following system states:

System State	Description	Comment
S0: Minimum value	Lowest frequency mode (LFM) with minimum core voltage during desktop idle	
S0: Maximum value	Highest frequency mode (HFM/Turbo Boost).	The CPU was stressed to its maximum frequency
S0: Peak current	Highest current spike during the measurement of "S0: Maximum value". This state shows the peak value during runtime	Consider this value when designing the system's power supply, to ensure sufficient power is supplied during worst case scenarios
S3	SBC is powered by 12 V	
S5	SBC is powered by 12 V	



Note

1. *The fan and SATA drives were powered externally.*
2. *All other peripherals except the LCD monitor were disconnected before measurement.*

Table 8 Power Consumption Values

The table below provides additional information about the conga-JC370 power consumption. The values are recorded at various operating mode.

Part No.	Memory Size	H.W Rev.	BIOS Rev.	OS (64 bit)	CPU			Current (Amp.)				
					Variant	Cores	Freq. /Max. Turbo	S0: Min	S0: Max	S0: Peak	S3	S5
054001	2 x 4 GB	A.2	R124	Windows 10	Intel® Core™ i7-8665UE	4	1.7 / 4.4 GHz	0.33	1.62	2.03	0.07	0.05
054002	2 x 4 GB	A.2	R124	Windows 10	Intel® Core™ i5-8365UE	4	1.6 / 4.1 GHz	0.45	1.63	1.97	0.11	0.09
054003	2 x 4 GB	A.2	R124	Windows 10	Intel® Core™ i3-8145UE	2	2.2 / 3.9 Ghz	0.34	3.15	3.98	0.07	0.05
054005	2 x 4 GB	A.2	R124	Windows 10	Intel® Celeron® 4305UE	2	2.0 / N.A GHz	0.32	0.92	1.08	0.07	0.05

 **Note**

With a fast input voltage rise time, the inrush current may exceed the measured peak current.

2.6 Supply Voltage Battery Power

Table 9 CMOS Battery Power Consumption

RTC @	Voltage	Current
-10°C	3V DC	6.22 µA
20°C	3V DC	2.77 µA
70°C	3V DC	2.04 µA

 **Note**

1. Do not use the CMOS battery power consumption values listed above to calculate CMOS battery lifetime.
2. Measure the CMOS battery power consumption in your customer specific application in worst case conditions (for example, during high temperature and high battery voltage).
3. Consider also the self-discharge of the battery when calculating the lifetime of the CMOS battery. For more information, refer to application note AN9_RTC_Battery_Lifetime.pdf on congatec AG website at www.congatec.com/support/application-notes.
4. We recommend to always have a CMOS battery present when operating the conga-JC370

2.7 Environmental Specifications

Temperature Operation: 0° to 60°C Storage: -20° to +70°C

Humidity Operation: 10% to 90% Storage: 5% to 95%



The above operating temperatures must be strictly adhered to at all times. Humidity specifications are for non-condensing conditions.

3 Block Diagram

conga-JC370

3.5" Juke Single Board Computer

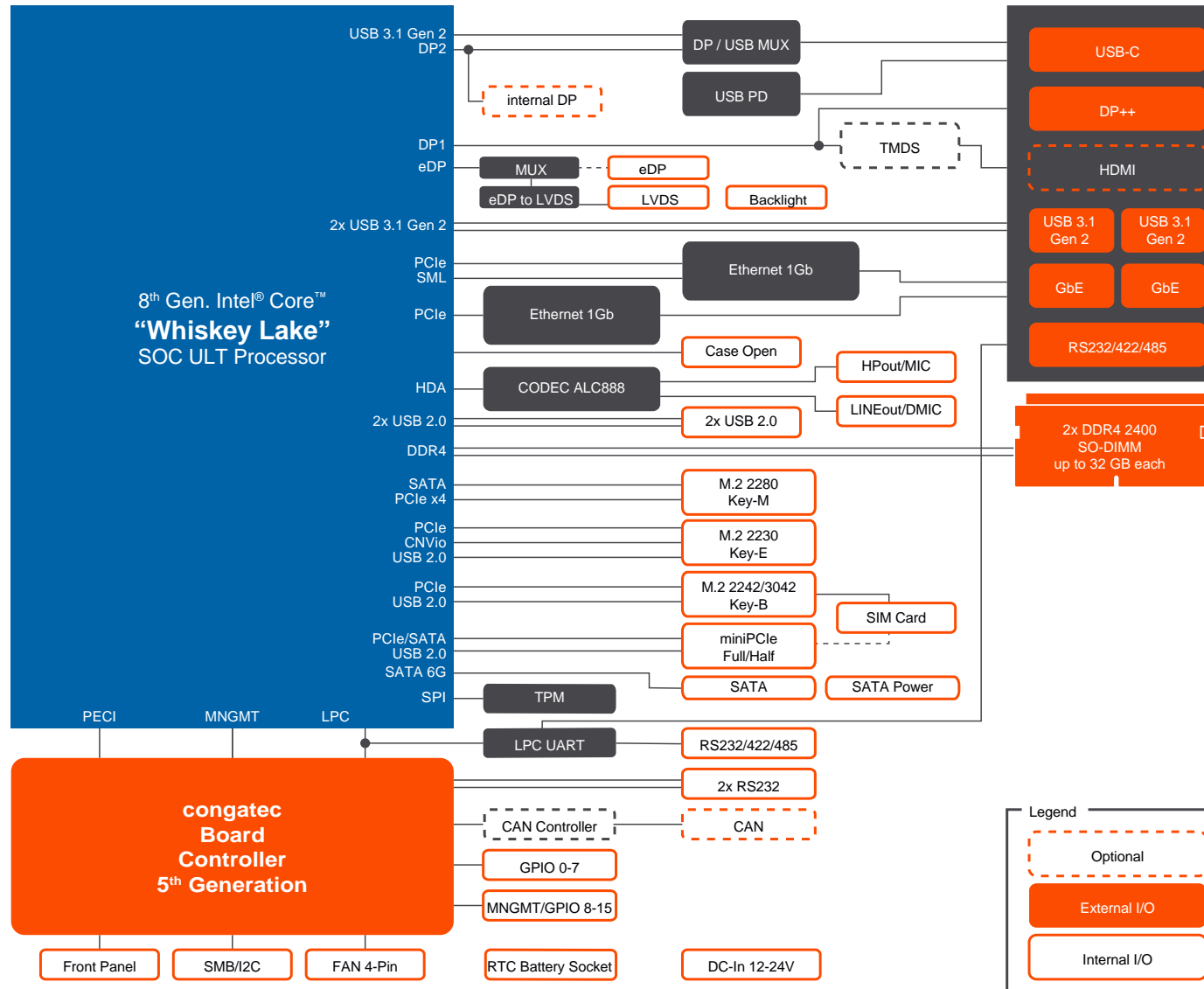

4 Cooling Solution

The conga-JC370 supports the cooling solutions listed in the table below. The dimensions of the cooling solutions are shown in the sub-sections. All measurements are in millimeters.

Table 10 Cooling Solution Variants

	Cooling Solution	Part No.	Description
1	CSA	054050	Active cooling solution with integrated heat pipes and 2.7 mm bore-hole standoffs
		054051	Active cooling solution with integrated heat pipes and M2.5 mm threaded standoffs
2	CSP	054052	Passive cooling solution with integrated heat pipes and 2.7 mm bore-hole standoffs
		054053	Passive cooling solution with integrated heat pipes and M2.5 mm threaded standoffs
3	HSP	054054	Heatspreader with integrated heat pipes and 2.7 mm bore-hole standoffs
		054055	Heatspreader with integrated heat pipes and M2.5 mm threaded standoffs



Note

1. We recommend a maximum torque of 0.4 Nm for SBC mounting screws and 0.5 Nm for CPU mounting screws.
2. The gap pad material used on congatec heatspreaders may contain silicon oil that can seep out over time depending on the environmental conditions it is subjected to. For more information about this subject, contact your local congatec sales representative and request the gap pad material manufacturer's specification.



Caution

1. The congatec heatspreaders/cooling solutions are tested only within the commercial temperature range of 0° to 60°C. Therefore, if your application that features a congatec heatspreader/cooling solution operates outside this temperature range, ensure the correct operating temperature of the SBC is maintained at all times. This may require additional cooling components for your final application's thermal solution.
2. For adequate heat dissipation, use the mounting holes on the cooling solution to attach it to the SBC. Apply thread-locking fluid on the screws if the cooling solution is used in a high shock and/or vibration environment. To prevent the standoff from stripping or cross-threading, use non-threaded carrier board standoffs to mount threaded cooling solutions.
3. For applications that require vertically-mounted cooling solution, use only coolers that secure the thermal stacks with fixing post. Without the fixing post feature, the thermal stacks may move.
4. Do not exceed the recommended maximum torque. Doing so may damage the SBC.

4.1 CSA Dimensions

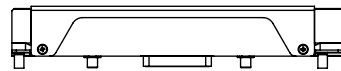
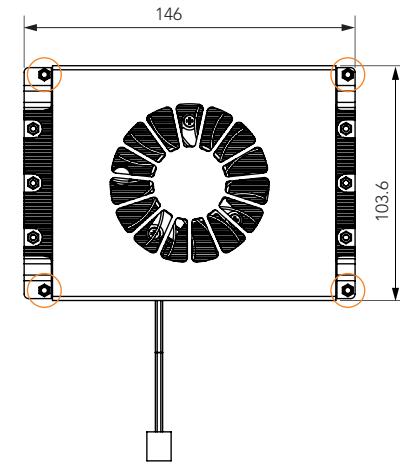
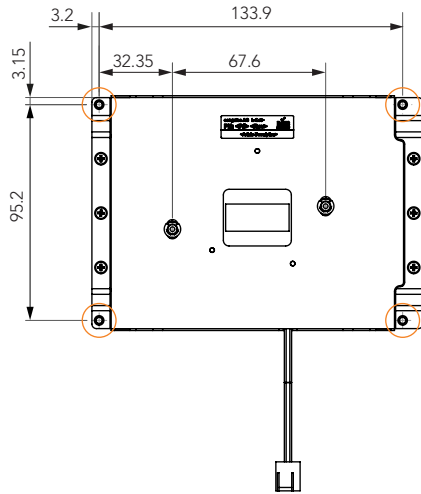

 M2.5 x 8 mm threaded standoff for threaded version or $\varnothing 2.7 \times 8$ mm non-threaded standoff for borehole version

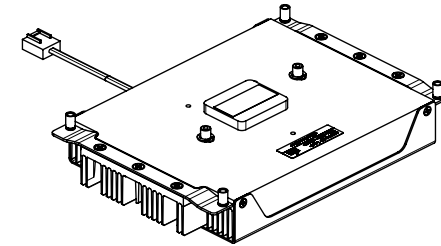
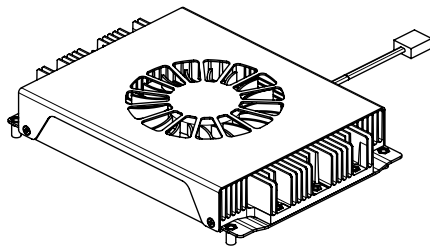
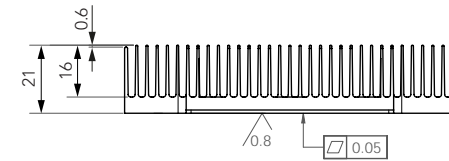

4.2 CSP Dimensions

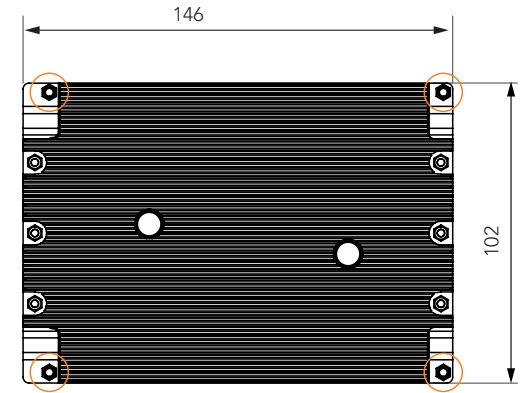
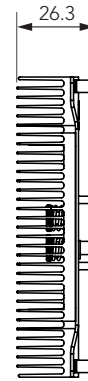
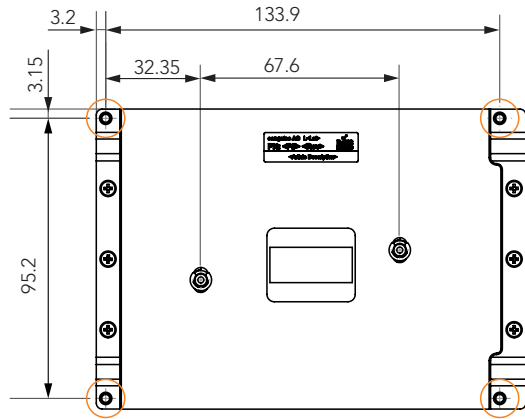

-  M2.5 x 8 mm threaded standoff for threaded version or $\varnothing 2.7 \times 8$ mm non-threaded standoff for borehole version

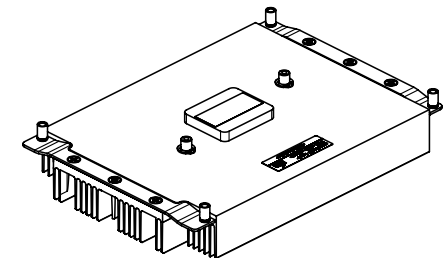
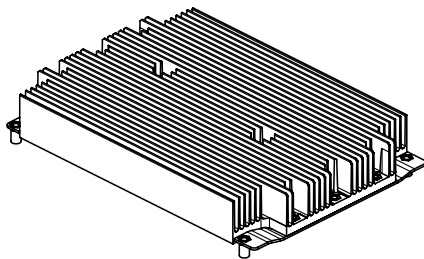
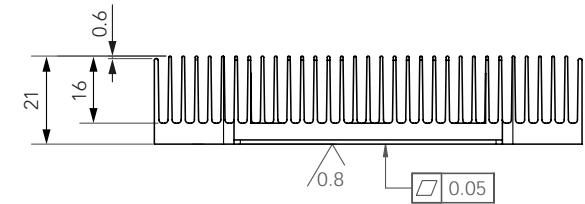

4.3 HSP Dimensions

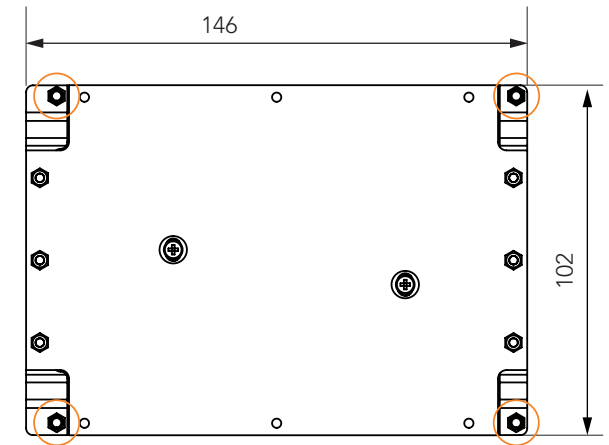
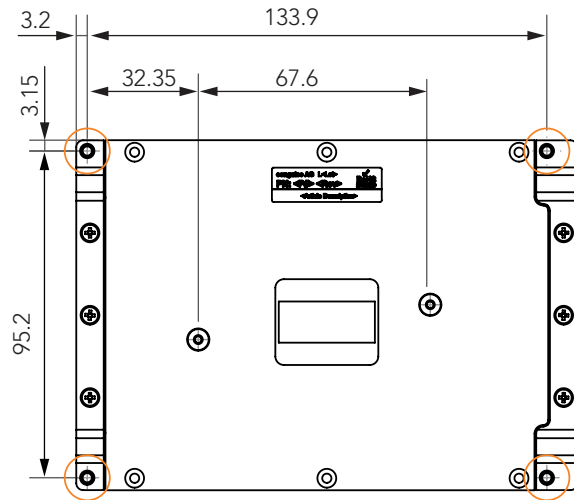

 M2.5 x 8 mm
 threaded standoff
 for threaded version
 or
 ø2.7 x 8 mm
 non-threaded standoff
 for borehole version

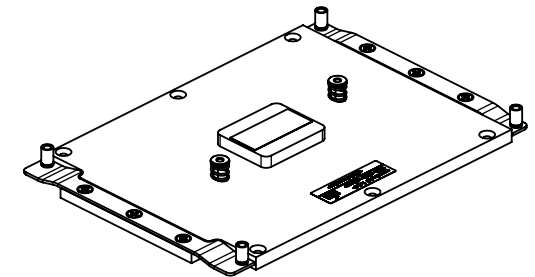
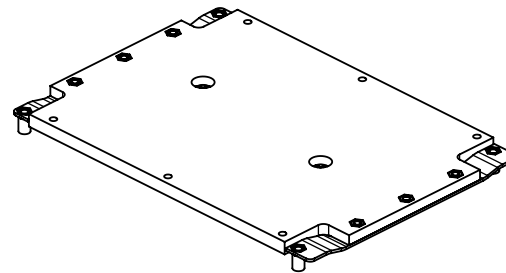
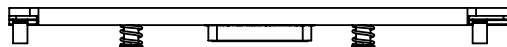

5 Connector Description

5.1 Power Supply Connectors

The conga-JC370 provides a 4-pin Mini-Fit connector. The power input is protected by a 15A non-resettable fuse. Alternatively, the conga-JC370 can be powered by USB Type-C.



Note
The conga-JC370 turns on immediately power is supplied. To change this default setting, enter the BIOS setup menu under "Boot Settings Configuration" and set the "Power Loss Control" to "Remain OFF".

5.1.1 Mini-Fit 4-Pin Connector

The conga-JC370 provides an internal 4-pin Mini-Fit connector with voltage protection.

Table 11 Connector X34 Pinout Description

Pin	Signal	Description
1	GND	Ground
2	GND	Ground
3	+12V-24V	Power supply +12-24V
4	+12V-24V	Power supply +12-24V

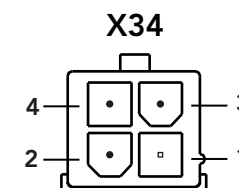

Note
The conga-JC370 offers a right-angle, 4-pin Mini-Fit connector via assembly option.

Connector Type

X34 : 2 x 2-pin, 4.2 mm pitch Mini-Fit connector (Molex 87427-0442)

Possible Mating Connector: Molex 39012040

5.1.2 USB Type-C Port

The USB Type-C port on the conga-JC370 supports power sink of 12–20 V at 3–5 A.



Note

1. The conga-JC370 will not turn on if the USB Type-C adapter provides less than 12V or 3 A.
2. Do not use a power adapter with less than 60 W rating

X19



5.1.3 Power Status LEDs

The LED D57 shows the power state of the conga-JC370 as described in the table below. Optionally, you can connect an LED to pins 9 and 10 of connector X4 for power state indication (see section 5.12 “Front Panel Header”).

Table 12 D57 LED States

LED Status	ACPI State	Description
Steady red	S5	Soft-off
Steady green	S0	System on and running
Steady yellow	S3	Suspend to RAM (sleep)

5.1.4 Power-On Control Jumper

The conga-JC370 provides jumper JP2 for controlling the power-on control feature.

Table 13 Auto Power-On Control

Jumper	Configuration
1-2	Enables auto power-on control regardless of the BIOS settings
Open	Power-on feature is controlled via the BIOS setup menu. The power-on control is enabled in the BIOS setup menu by default

5.1.5 CMOS Battery Header

The conga-JC370 provides a CR2032 CMOS battery which is connected to pin header X36. The battery supplies power to maintain the CMOS settings and real time clock.

Table 14 X36 Pin Header

Pin	Description
1	RTC power (+3V)
2	Ground reference



Warning

Danger of explosion if battery is incorrectly replaced. Replace only with same or equivalent type recommended by the manufacturer. Dispose of used batteries according to the manufacturer's instructions.



Connector Type

X36 : 2-pin, 1.25 mm pitch Molex PicoBlade header (Molex 0533980271)

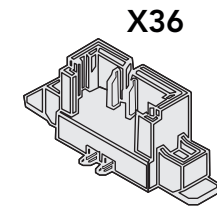

5.2 Extension Sockets

The conga-JC370 provides the following extension sockets:

- Mini Card—full or half size (PCIe x1/SATA/USB)
- M.2 key B, type 2242/3042 (PCIe x2/USB/SIM)
- M.2 key E, type 2230 (PCIe x1/USB/CNVi)
- M.2 key M, type 2280 (PCIe x4/SATA/Intel® Optane™)

5.2.1 Mini Card Socket

The conga-JC370 provides a Mini Card socket (X26). The socket supports full or half size PCIe, SATA or USB 2.0 cards.

Table 15 X26 Pinout Description

Pin	Signal	Pin	Signal
1	WAKE#	2	+3.3V
3	N.C	4	GND
5	N.C	6	+1.5V
7	CLKREQ#	8	N.C
9	GND	10	N.C
11	REFCLK-	12	N.C
13	REFCLK+	14	N.C
15	GND	16	N.C
17	N.C	18	GND
19	N.C	20	W_DISABLE#
21	GND	22	PERST#
23	PERn0	24	+3.3V
25	PERp0	26	GND
27	GND	28	+1.5V
29	GND	30	SMB_CLK
31	PETn0	32	SMB_DATA
33	PETp0	34	GND
35	GND	36	USB_D-
37	GND	38	USB_D+

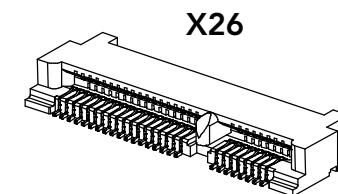

Pin	Signal	Pin	Signal
39	+3.3V	40	GND
41	+3.3V	42	N.C
43	PCIe/SATA detection	44	N.C
45	N.C	46	N.C
47	N.C	48	+1.5V
49	N.C	50	GND
51	N.C	52	+3.3V

Connector Type

X26: Standard Mini Card socket (full size or half size)

5.2.2 M.2 Key B Socket

The conga-JC370 provides an M.2 key B, type 2242/3042 socket (X24) for connecting a PCIe or USB (WWAN) card.

Table 16 X24 Pinout Description

Pin	Signal	Pin	Signal
1	N.C	2	+3.3V
3	GND	4	+3.3V
5	GND	6	FULL_CARD_PWROFF#
7	USB_D+	8	W_DISABLE_1#
9	USB_D-	10	N.C
11	GND	12	Key
13	Key	14	
15		16	
17		18	
19		20	N.C
21	N.C	22	N.C
23	WoWWAN#	24	N.C
25	N.C	26	W_DISABLE_2#
27	GND	28	N.C
29	PER1-	30	UIM_RESET

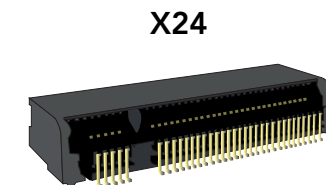

Pin	Signal	Pin	Signal
31	PER1+	32	UIM_CLK
33	GND	34	UIM_DATA
35	PET1-	36	UIM_PWR
37	PET1+	38	N.C
39	GND	40	N.C
41	PER0-	42	N.C
43	PER0+	44	N.C
45	GND	46	N.C
47	PET0-	48	N.C
49	PET0+	50	PERST#
51	GND	52	CLKREQ#
53	REFCLK-	54	PEWAKE#
55	REFCLK+	56	N.C
57	GND	58	N.C
59	N.C	60	COEX3
61	N.C	62	COEX2
63	N.C	64	COEX1
65	N.C	66	N.C
67	RESET#	68	N.C
69	N.C	70	+3.3V
71	GND	72	+3.3V
73	GND	74	+3.3V
75	N.C		

 **Note**

The micro-SIM card slot is connected to the UIM interface by default.

 **Connector Type**

X24: Standard PCIe M.2 key B socket

5.2.3 M.2 Key E Socket

The conga-JC370 provides an M.2 key E, type 2230 socket (X27) for connecting a PCIe, USB or Intel® CNVi WLAN card.

Table 17 X27 Pinout Description

Pin	Signal	Pin	Signal
1	GND	2	+3.3V
3	USB_D+	4	+3.3V
5	USB_D-	6	LED#1
7	GND	8	PCM_CLK/I2S_SCK
9	CNV_WR_D1-	10	PCM_SYNC/I2S_WS
11	CNV_WR_D1+	12	PCM_IN/I2S_SD_IN
13	GND	14	PCM_OUT/I2S_SD_OUT
15	CNV_WR_D0-	16	LED#2
17	CNV_WR_D0+	18	GND
19	GND	20	BT_WAKE#
21	CNV_WR_CLK-	22	CNV_BRI_RSP
23	CNV_WR_CLK+	24	
25	Key	26	Key
27		28	
29		30	
31		32	
33	GND	34	CNV_RGI_RSP
35	PET0+	36	CNV_BRI_DT
37	PET0-	38	CL_RST#
39	GND	40	CL_DATA
41	PER0+	42	CL_CLK
43	PER0-	44	COEX3
45	GND	46	COEX2
47	REFCLK0+	48	COEX1
49	REFCLK0-	50	SUSCLK
51	GND	52	PERST#0
53	CLKREQ0#	54	RSVD/W_DISABLE#2
55	PEWAKE0#	56	W_DISABLE#1

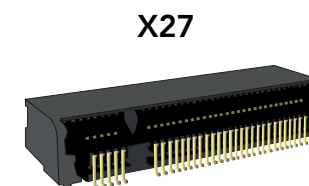

Pin	Signal	Pin	Signal
57	GND	58	N.C
59	CNV_WT_D1-	60	N.C
61	CNV_WT_D1+	62	N.C
63	GND	64	CNV_REFCLK
65	CNV_WT_D0-	66	PERST#1
67	CNV_WT_D0+	68	N.C
69	GND	70	N.C
71	CNV_WT_CLK-	72	+3.3V
73	CNV_WT_CLK+	74	+3.3V
75	GND		

Connector Type

X27: Standard PCIe M.2 key E socket

5.2.4 M.2 Key M Socket

The conga-JC370 provides an M.2 key M, type 2280 socket (X28) for connecting a PCIe x4 SSD (NVMe), SATA SSD or Intel® Optane™.

Table 18 X28 Pinout Description

Pin	Signal	Pin	Signal
1	GND	2	+3.3V
3	GND	4	+3.3V
5	PER3-	6	N.C
7	PER3+	8	N.C
9	GND	10	N.C
11	PET3-	12	+3.3V
13	PET3+	14	+3.3V
15	GND	16	+3.3V
17	PER2-	18	+3.3V
19	PER2+	20	N.C
21	GND	22	N.C
23	PET2-	24	N.C

X28

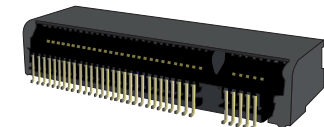

Pin	Signal	Pin	Signal
25	PET2+	26	N.C
27	GND	28	N.C
29	PER1-	30	N.C
31	PER1+	32	N.C
33	GND	34	N.C
35	PET1-	36	N.C
37	PET1+	38	SATA_DEVSLP
39	GND	40	N.C
41	PER0-/SATA_B+	42	N.C
43	PER0+/SATA_B-	44	N.C
45	GND	46	N.C
47	PET0-/SATA_A-	48	N.C
49	PET0+/SATA_A+	50	PERST#
51	GND	52	CLKREQ#
53	REFCLK-	54	N.C
55	REFCLK+	56	N.C
57	GND	58	N.C
59	Key	60	Key
61		62	
63		64	
65		66	
67	N.C	68	N.C
69	PEDET	70	+3.3V
71	GND	72	+3.3V
73	GND	74	+3.3V
75	GND		

Connector Type

X28: Standard PCIe M.2 key M socket

5.2.5 PCI Express Routing

The diagram below shows how the PCIe lanes are routed to the expansion sockets.

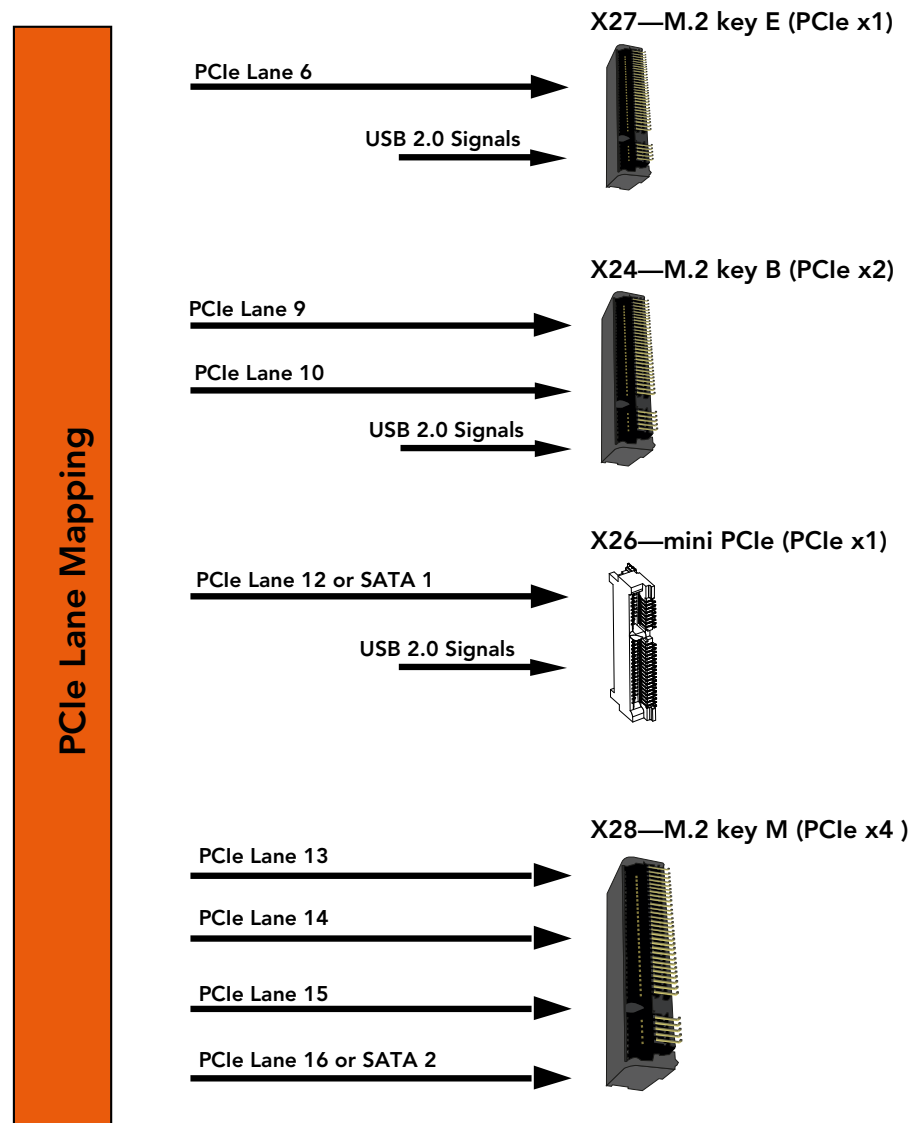

5.3 Display Interfaces

The conga-JC370 supports three independent displays—a DP++, a USB Type-C and an LVDS or eDP panel. The graphic engine supports DirectX 12, OpenGL 4.5, OpenCL 2.1, Intel QuickSync and Clear Video Technology HD, hybrid graphics.

Optionally, the conga-JC370 can support HDMI instead of DP++, and iDP instead of USB Type-C.

5.3.1 Display Port

The conga-JC370 provides a DP++ port (X17). The port supports:

- VESA DisplayPort Standard 1.2
- data rate of 5.4 GT/s with four data lanes
- resolutions up to 4096 x 2304 at 60 Hz
- audio formats such as AC-3 Dolby Digital, Dolby Digital Plus, DTS-HD, LPCM, Dolby TrueHD, DTS-HD Master audio
- HDMI and DVI with appropriate adapter

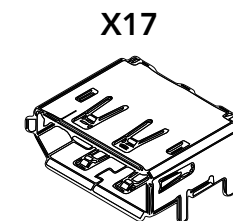

Note

The conga-JC370 supports resolutions up to 4k only if you populate both memory sockets with modules of same size and speed.



Connector Type

X17: Standard DisplayPort connector

5.3.2 USB Type-C Alternate Mode

The conga-JC370 provides a USB Type-C port (X19) for connecting USB or DisplayPort (alternate mode). The port supports:

- USB 3.1 Gen. 2
- VESA DisplayPort Standard 1.2
- resolutions up to 4096 x 2304 at 60 Hz
- power delivery of up to 5V @ 3A

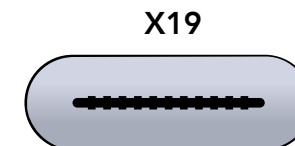

Connector Type

X19: Standard USB Type-C port

5.3.3 LVDS/eDP Header

The conga-JC370 provides an LVDS interface on connector X15. The interface is located on the top side of the SBC and supports the following:

- 18 or 24 bit, single or dual channel
- selectable panel voltage
- VESA or JEIDA data mapping
- ANSI/TIA/EIA-644-1-2001 standard
- automatic panel detection (EDID)
- resolution up to 1920 x 1200 in dual LVDS mode

Table 19 Connector X15 Pinout Description

Pin	Signal	Pin	Signal
1	VCC (fuse with 1 A hold current)	2	VCC (fuse with 1.5 A hold current at 25°C)
3	VCC (fuse with 1 A hold current)	4	VCC (fuse with 1.5 A hold current at 25°C)
5	VCC_EDID (+3.3 V)	6	GND
7	EDID_CLK	8	EDID_DATA
9	VDDEN	10	eDP_HPD (not connected if LVDS is supported)
11	GND	12	GND
13	LVDS_ODD_TX0N / eDP_TX0N	14	LVDS_ODD_TX1N / eDP_TX1N
15	LVDS_ODD_TX0P / eDP_TX0P	16	LVDS_ODD_TX1P / eDP_TX1P
17	GND	18	GND
19	LVDS_ODD_TX2N / eDP_TX2N	20	LVDS_ODD_CLKN / eDP_AUXN
21	LVDS_ODD_TX2P / eDP_TX2P	22	LVDS_ODD_CLKP / eDP_AUXP
23	GND	24	GND
25	LVDS_ODD_TX3N / eDP_TX3N	26	LVDS_EVEN_TX0N
27	LVDS_ODD_TX3P / eDP_TX3P	28	LVDS_EVEN_TX0P
29	GND	30	GND
31	LVDS_EVEN_TX1N	32	LVDS_EVEN_TX2N
33	LVDS_EVEN_TX1P	34	LVDS_EVEN_TX2P
35	GND	36	GND
37	LVDS_EVEN_CLKN	38	LVDS_EVEN_TX3N
39	LVDS_EVEN_CLKP	40	LVDS_EVEN_TX3P

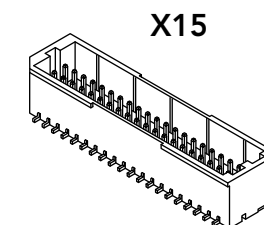



Note

1. EDID signals and VDDEN output are 3.3 V.
2. The maximum output current for LCD and backlight power rails is 1.5 A.
3. Use ODD pins for single channel LVDS panel.
4. eDP support via assembly option

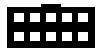

Connector Type

X15: 40-pin, 1 mm pitch header (JST BM40B-SRDS-G-TF)
Possible Mating Connector: JST SHDR-40V-S-B

5.3.3.1 Panel Voltage Selection Jumper

The conga-JC370 supports 3.3V, 5V and 12V LCD panels. Use jumper JP1 to set the panel voltage.

Table 20 JP1 Pinout Description

Jumper	Panel Voltage
2-4	5V
3-4	12V
4-6	3.3V (default)



Connector Type

JP1: 2.54 mm, 2 x 3-pin header (without pins 1 and 5)

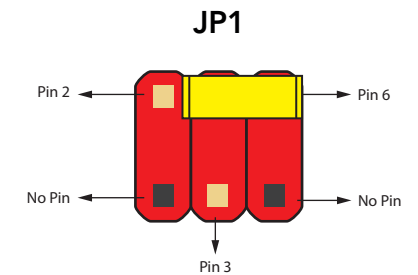

5.3.3.2 Backlight Control Voltage Selection Jumper

The conga-JC370 supports LCD backlight control signals with 3.3 V or 5 V. Use jumper JP3 to select the voltage level.

Table 21 JP3 Pinout Description

Jumper	Backlight Control Voltage
1-2	5V (default)
Open	3.3V

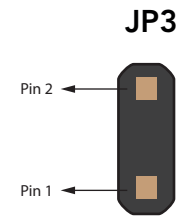

Connector Type

JP3: 2.54 mm, 1 x 2-pin header

5.3.3.3 Backlight Power Header

The conga-JC370 provides header X14. The maximum hold current is 1.5 A.

Table 22 Connector X14 Pinout Description

Pin	Signal Name	Description
1	+12V	12 V backlight inverter power (1.5 A fuse)
2	+12V	12 V backlight inverter power (1.5 A fuse)
3	GND	Backlight ground
4	GND	Backlight ground
5	eDP_LVDS_BKLT_EN	Backlight enable
6	eDP_LVDS_BKLT_CTRL	Backlight control
7	+5V	5 V backlight inverter power (1.5 A fuse)
8	+5V	5 V backlight inverter power (1.5 A fuse)

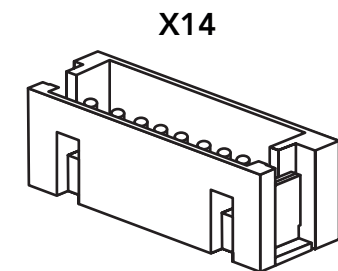

Note

The backlight enable and control signals are 3.3 V or 5 V output signals. Select the voltage level with jumper JP3.

Connector Type

X14: 2 mm, 8-pin Crimp style connector (JST B8B-ZR-SM4-TF)

Possible Mating Connector: JST ZHR-8

5.4 USB Connectors

The conga-JC370 provides two USB 3.1 Gen. 2 Type-A ports, two USB 2.0 ports and one USB Type-C port.

5.4.1 USB 3.1 Gen. 2 Port

The conga-JC370 provides two USB 3.1 Gen. 2 ports on connector X20. Each port supports a maximum current of 1 A.

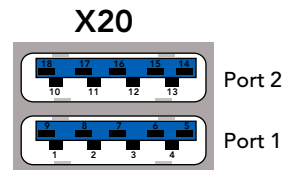

Connector Type

X20: Dual-stacked USB 3.0 type A connector

5.4.2 USB 2.0 Header

The conga-JC370 provides two USB 2.0 ports via header X21. Each port supports a maximum current of 0.5 A.

Table 23 Connector X21 Pinout Description

USB Port 7			USB Port 8		
Pin	Signal	Description	Pin	Signal	Description
1	+5V	+5V supply	2	+5V	+5V supply
3	USB7-	USB Port 7, Data-	4	USB8-	USB Port 8, Data-
5	USB7+	USB Port 7, Data+	6	USB8+	USB Port 8, Data+
7	GND	Ground	8	GND	Ground
9	SHLD	Cable shield	10	SHLD	Cable shield

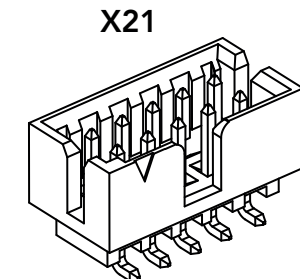

Connector Type

X21: 2 mm pitch, 2 x 5-pin shrouded header (Molex 0878321014)

Possible Mating Connector: Molex 511101051

5.4.3 USB Type-C Port

The conga-JC370 provides one USB Type-C port on connector X19. The port supports USB 3.1 Gen. 2, DisplayPort 1.2 and power delivery up to 5V @ 3A.

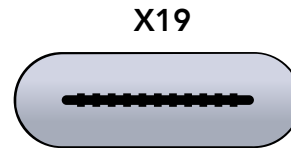

Connector Type

X19: USB Type-C connector

5.5 SATA Connectors

The conga-JC370 provides a standard SATA 3.0 port, an mSATA/mPCIe socket, an M.2 key M socket and a SATA power header.

5.5.1 Standard SATA Port

The conga-JC370 provides a standard SATA 3.0 port on X29. The port supports:

- SATA, eSATA or SATADOM with appropriate cable
- pin 7 power source for SATADOMs (disabled in the BIOS setup menu by default)
- pin 8 power source for SATADOMs

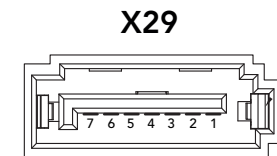

To show SATA port activity, connect an LED to pin 11 and 12 of the front panel connector X4.

Note

1. Enable pin 7 power source in the BIOS setup menu under "Chipset ->Platform Controller Hub -> SATA and RST Configuration -> SATADOM Power Pin 7" and select "SATADOM".
2. To use pin 8 power source, disable pin 7 power source in the BIOS setup menu under "Chipset ->Platform Controller Hub -> SATA and RST Configuration -> SATADOM Power Pin 7" and select "SATA SSD/HDD".

Connector Type

X29: Standard SATA connector

5.5.2 mSATA Socket

The conga-JC370 provides an mSATA socket (X26) for connecting a SATA or PCIe device. Refer to section 5.2.1 “Mini Card Socket” for X26 pinout description.

5.5.3 M.2 Key M Socket

The conga-JC370 provides an M.2 key M, type 2280 socket (X28) for connecting a SATA SSD. Refer to section 5.2.4 “M.2 Key M Socket” for X28 pinout description.

5.5.4 SATA Power Header

The conga-JC370 provides a 2-pin SATA power header (X30) for 2.5” HDD or SSD. The header supplies 5 V with a maximum current of 1.5 A.

Table 24 X30 Pinout Description.

Pin	Signal
1	5V (maximum 1.5A)
2	GND

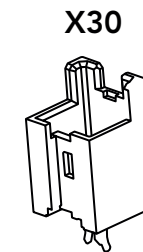

Connector Type

X30: 2.5 mm pitch, 2-pin header (Molex 533750210)

Possible Mating Connector: Molex 511030200

5.6 Ethernet

The conga-JC370 provides two Gigabit Ethernet ports (X22 and X23). X22 interface is equipped with Intel i219-LM controller on i7 and i5 variants and with Intel i219-V controller on i3 and Celeron variants.

X23 interface is equipped with Intel i255-LM controller by default but can be equipped with Intel i225-V by assembly option.

Table 25 GbE LED Description

LED Left Side	Description	LED Right Side	Description
Off	10 Mbps link speed	Off	No link
Green	100 Mbps link speed	Steady On	Link established, no activity detected
Orange	1000 Mbps link speed	Blinking	Link established, activity detected

X22/X23

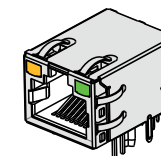

Note

1. Only variants with Intel i219-LM support Intel vPro/AMT technology.
2. Only variants with Intel i255-LM support TSN.
3. TSN is supported on only Linux OS



Connector Type

X22,X23: 8-pin RJ45 connector with gigabit magnetic and LEDs

5.7 HDA Header

The conga-JC370 features a high definition audio codec (Realtek ALC888S). The codec supports:

- digital MIC and Line-OUT signals on header X31
- headphone-OUT and MIC-IN signals on header X32

Table 26 X31 Pinout Description

Pin	Signal	Description
1	FRONT_R	Analog front - right channel
2	FRONT_L	Analog front - left channel
3	A_GND	Analog ground (return path for analog front)
4	SENSE_A	Jack detection for analog front output

X31

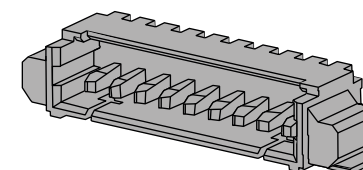

Pin	Signal	Description
5	+5V	5 V power supply (protected by 500 mA resettable fuse)
6	+3.3V	3.3 V power supply for DMIC (protected by 500 mA resettable fuse)
7	DMIC_DATA	Serial data from digital MIC (3.3 V level signal)
8	GND	Ground reference for DMIC
9	DMIC_CLK	Digital MIC serial clock (3.3 V level signal)

Table 27 X32 Pinout Description

Pin	Signal	Description
1	LINE2_R	Analog line / headphone output - right channel
2	LINE2_L	Analog line / headphone output - left channel
3	A_GND	Analog ground
4	SENSE_B_HPOUT	Headphone jack detection
5	SENSE_B_MIC	MIC jack detection
6	A_GND	Analog ground
7	MIC2_L	Analog microphone input - left channel
8	MIC2_R	Analog microphone input - right channel

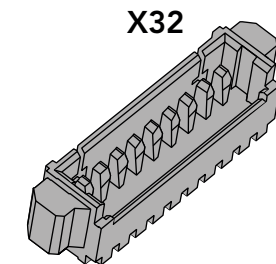

Connector Type

X31: 9-pin, 1.25 mm pitch picoblade header (Molex 0532610971)

X32: 8-pin, 1.25 mm pitch picoblade header (Molex 0533980871)

Possible Mating Connector: Molex 0510210900 for X31 and Molex 0510210800 for X32

5.8 COM Port Headers

The conga-JC370 provides four COM ports:

- COM port 1 and 2 via an LPC to UART bridge
- COM port 3 and 4 via the congatec Board Controller

5.8.1 COM Port 1 and 2 Connectors

The conga-JC370 provides COM port 1 on D-SUB9 connector X10 and COM port 2 on pin header X11. The ports support RS232, RS422 and RS485 I/O voltage levels. Select the COM port protocol in the BIOS setup menu.

Table 28 X11 Pinout Description

Pin	RS232	RS422	RS485	Description
1	DCD			Data Carrier Detect
2	DSR			Data Set Ready
3	RXD	RX-	DATA-	Receive Data/Receive Data +
4	RTS	TX+	DATA+	Request to Send/Transmit Data +
5	TXD	TX-	DATA-	Transmit Data/Transmit Data -
6	CTS	RX+	DATA+	Clear to Send/Receive Data -
7	DTR			Data Terminal Ready
8	RI			Ring Indicator
9	GND			Ground

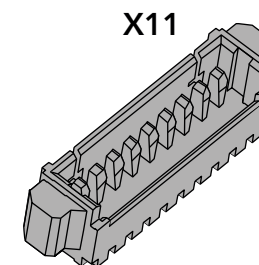
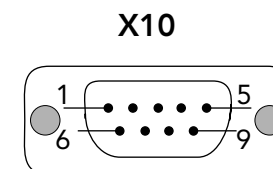

Table 29 X10 Pinout Description

Pin	RS232	RS422	RS485	Description
1	DCD			Data Carrier Detect
2	RXD	RX-	DATA-	Receive Data
3	TXD	TX-	DATA-	Transmit Data
4	DTR			Data Terminal Ready
5	GND			Ground
6	DSR			Data Set Ready
7	RTS	TX+	DATA+	Request to Send/Transmit Data
8	CTS	RX+	DATA+	Clear to Send/Receive Data
9	RI			Ring Indicator





Note

1. The mating RS422/RS485 connector must have a termination resistor.
2. The mating RS485 connector must connect the DATA+ pins together and the DATA- pins together.



Connector Type

X10: Standard 9-pin DSUB male connector

X11: 9-pin, 1.25 mm pitch picoblade header (Molex 0533980971)

Possible Mating Connector: Molex 0510210900

5.8.2 COM Port 3 and 4 Headers

The conga-JC370 provides COM port 3 on X12 and COM port 4 on X13. The ports support RS 232 voltage level.

Table 30 X12/X13 Pinout Description

Pin	Signal	Description
1	GND	Ground
2	TXD	Transmit data
3	RTS	Request to Send
4	CTS	Clear to Send
5	RXD	Receive data



Connector Type

X12/X13: 5-pin, 1.25 mm pitch picoblade header (Molex 0533980571)

Possible Mating Connector: Molex 0510210500

X12/X13

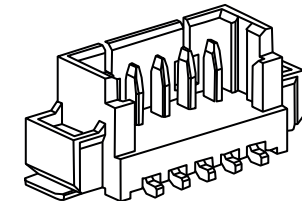

5.9 GPIO Header

The conga-JC370 provides eight GPIOs on connector X5, via the congatec Board Controller. The 3.3V is provided through a 500mA resettable fuse.

Table 31 X5 Pinout Description

Pin	Signal	Description
1	GPIO_0	General Purpose Input Output 0
2	GPIO_1	General Purpose Input Output 1
3	GPIO_2	General Purpose Input Output 2
4	GPIO_3	General Purpose Input Output 3
5	GND	Ground
6	GPIO_4	General Purpose Input Output 4
7	GPIO_5	General Purpose Input Output 5
8	GPIO_6	General Purpose Input Output 6
9	GPIO_7	General Purpose Input Output 7
10	+ 3.3 V	3.3 V supply (standby)

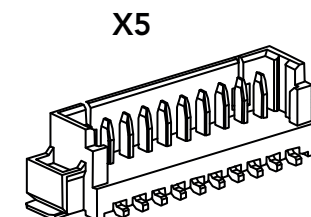

Connector Type

X5: 10-pin, 1.25 mm pitch picoblade header (Molex 0533981071)

Possible Mating Connector: Molex 0510211000

5.10 System Management Header

The conga-JC370 provides header X6 for system management. The header can alternatively support eight GPIOs (GPIO_8 to GPIO_15) via assembly option.

Table 32 X6 Pinout Description

Pin	Signal	Description
1	PWROK/GPIO_8	Power good/General Purpose Input Output 8
2	PM_BATLOW#/GPIO_9	Battery low signal/General Purpose Input Output 9
3	GBE2_SDP0/GPIO_10	Gigabit Ethernet Software-Definable Pin/General Purpose Input Output 10
4	WDG_TRIG#/GPIO_11	Watchdog trigger/General Purpose Input Output 11
5	GND	Ground
6	PM_SLP_S3#/GPIO_12	Suspend to RAM state (active low output)/General Purpose Input Output 12
7	PM_SLP_S4#/GPIO_13	Suspend to Disk state (active low output)/General Purpose Input Output 13

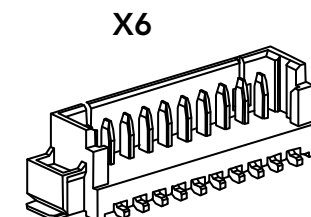

8	PM_SLP_S5#/GPIO_14	Soft-off state/General Purpose Input Output 14
9	WDG_EVENT/GPIO_15	Watchdog event/General Purpose Input Output 15
10	+ 3.3 V	3.3 V supply (standby)

5.11 I²C Bus/SM Bus Header

The conga-JC370 provides header X7 for I²C/SM bus signals. The 3.3 V is provided through a 500mA resettable fuse.

Table 33 X7 Pinout Description

Pin	Signal	Description
1	PM_THRM#	Thermal event from external sensor (should be driven by open drain/collector output)
2	I2C_DAT	I2C data
3	GND	Ground reference
4	I2C_CLK	I2C clock output
5	+3.3 V	+3.3 V (standby) power output with 500 mA fuse
6	SMB0_ALERT#	SMBus Alert signal from external device (should be driven by open drain/collector output)
7	SMB0_DAT	SMBus data
8	GND	Ground reference
9	SMB0_CLK	SMBus clock output
10	+ 3.3 V	+3.3 V power output with 500 mA (active in deep sleep)

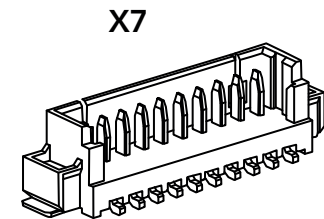

Note

1. All signals have 3.3 V level
2. Pin 5 is recommended for I2C devices while pin 10 is recommended for SMBus devices

Connector Type

X7: 10-pin, 1.25 mm pitch picoblade header (Molex 0533981071)

Possible Mating Connector: Molex 0510211000

5.12 Front Panel Header

The conga-JC370 provides X4 for front panel features such as lid, sleep, reset and power buttons, as well as status LEDs.

Table 34 X4 Pinout Description

Pin	Signal Name	Description
1	LID_BTN#	Active-low signal. Triggers sleep state, hibernation or shutdown (depends on OS configuration)
2	GND	Ground
3	SLP_BTN#	Active-low signal. Triggers sleep state or hibernation (depends on OS configuration)
4	GND	Ground
5	RST_BTN#	Active-low signal. Triggers hard reset (system is not kept in reset when connected to ground)
6	GND	Ground
7	PWR_BTN#	Active-low signal. Triggers power-up sequence. Pulse duration of ≥ 4 seconds triggers forced shutdown. The cBC can also trigger signal depending on the BIOS settings (see section 6.4.2 "Power Loss Control")
8	GND	Ground
9	PWR_LED (anode)	For connecting bidirectional LEDs. The LEDs light when the system is powered on. Main color (runtime state (S0)): pin 9 for anode and pin 10 for cathode Alternate color (sleep state (S5)): pin 9 for cathode and pin 10 for anode
10	GND (cathode)	
11	SATA_LED (anode)	LED indicates activity on the SATA, mSATA (X26) or M.2 Type M socket (X28) with SATA SSD (onboard series resistor makes it possible to connect the LEDs directly to the pins)
12	SATA_ACT# (cathode)	

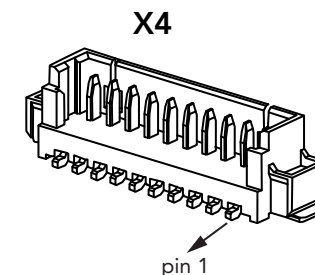

Connector Type

X4: 12-pin, 1.25 mm pitch (Molex 53398-1271)

Possible Mating Connector: Molex 0510211200

5.12.1 CPU Fan Header

The conga-JC370 provides pin header X9 for connecting a 3-pin or 4-pin 12V CPU fan. The recommended maximum power rating for the fan is 4W.

Table 35 X9 Pinout Description

Pin	Signal
1	GND
2	+12 VDC
3	FAN_TACHOIN
4	FAN_CTRL

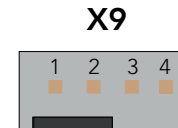

Note

1. The connector and pinout complies with 4-Wire Pulse PWM Controlled Fans Specification, Revision 1.3
2. FAN_TACHOIN fan output shall provide two pulses per revolution.
3. The fan must pull up the FAN_CTRL signal to high logic level

Connector Type

X9: 2.54 mm, 4-pin grid female fan connector

6 Additional Features

6.1 Micro-SIM Card

The conga-JC370 offers a micro-SIM slot on connector X25 for inserting SIM card.

Table 36 X25 Pinout Description

Pin	Signal	Description
C1	PWR	Power
C2	RST	Reset
C3	CLK	Clock
C4	N.A	Not available
C5	GND	Ground
C6	N.C	Not connected
C7	I/O	Data
C8	N.A	Not available

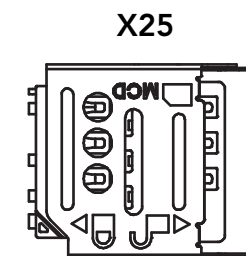

Connector Type

X25: Micro-SIM card socket (Molex 78800 series)

Note

1. The micro-SIM card slot is connected to the UIM interface of M.2 socket (X24) by default.
2. The slot can optionally be connected to the UIM interface of the mPCIe socket (X26).

6.2 Case-open Intrusion Connector

The conga-JC370 provides connector X3 for case-open intrusion detection.

Table 37 X3 Pinout Description

Pin	Function
1	INTRUDER#
2	GND

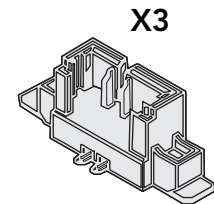

Connector Type

X3: 1.25 mm, 2-pin Molex Picoblade

6.3 External BIOS Flash

With pin header X37, the conga-JC370 can boot from an external 3.3 V SPI flash. For external BIOS flash, you need an SPI flash with a PCB adapter that connects to X37. For more information, contact congatec support.

Table 38 X37 Pinout Description

Pin	Signal	Description	Pin	Signal	Description
1	SPI_CS0B#	SPI flash CS# pin	2	VDD	Power supply (3.3V)
3	SPI_IO1	SPI flash MISO pin	4	SPI_IO3	SP flash HOLD# pin
5	SPI_IO2	SPI flash WP# pin	6	SPI_CLK	SPI flash clock input
7	GND	Ground	8	SPI_IO0	SPI flash MOSI pin
9	BIOS_EXT#	Enable booting from external SPI flash (active low)	10	SER1_TX	Serial port debug output

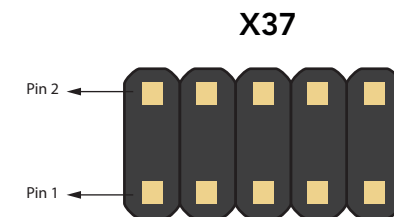

Connector Type

X37: 1.27 mm, 2 x 5-pin header

6.4 congatec Board Controller (cBC)

The conga-JC370 is equipped with a Microchip MEC1705 microcontroller. This onboard microcontroller plays an important role for most of the congatec BIOS features. It fully isolates some of the embedded features such as system monitoring, I²C bus from the x86 core architecture. The isolation helps improve performance and reliability even when the x86 processor is in a low power mode.

6.4.1 Fan Control

The cBC uses the PWM (FAN_PWMOUT) signal to adjust the rotational speed of the fan without changing the fan's input voltage. Additionally, the FAN_TACHOIN signal provides the ability to monitor the system's fan RPMs (revolutions per minute). For accurate RPM reading, the FAN_TACHOIN signal must receive two pulses per revolution. Therefore, a two pulse per revolution fan or similar hardware solution is recommended.

6.4.2 Power Loss Control

The cBC has full control of the power-up of the SBC; therefore, it can be used to specify the behavior of the system after an AC power loss condition. Supported modes are "Always On", "Remain Off" and "Last State".

6.4.3 Board Information

The cBC provides a rich data-set of manufacturing and board information such as serial number, EAN number, hardware and firmware revisions. It also keeps track of dynamically changing data like runtime meter and boot counter.

6.5 OEM BIOS Customization

The conga-JC370 is equipped with congatec Embedded BIOS, which is based on American Megatrends Inc. Aptio UEFI firmware. The congatec Embedded BIOS allows system designers to modify the BIOS. For more information about customizing the congatec Embedded BIOS, refer to the congatec System Utility user's guide CGUTLm1x.pdf on the congatec website at www.congatec.com or contact technical support.

The customization features supported are described below:

6.5.1 OEM Default Settings

This feature allows system designers to create and store their own BIOS default configuration. Customized BIOS development by congatec for OEM default settings is no longer necessary because customers can easily perform this configuration by themselves using the congatec system

utility CGUTIL. See congatec application note AN8_Create_OEM_Default_Map.pdf on the congatec website for details on how to add OEM default settings to the congatec Embedded BIOS.

6.5.2 OEM Boot Logo

This feature allows system designers to replace the standard text output displayed during POST with their own BIOS boot logo. Customized BIOS development by congatec for OEM Boot Logo is no longer necessary because customers can easily perform this configuration by themselves using the congatec system utility CGUTIL. See congatec application note AN11_Create_And_Add_Bootlogo.pdf on the congatec website for details on how to add OEM boot logo to the congatec Embedded BIOS.

6.5.3 OEM POST Logo

This feature allows system designers to replace the congatec POST logo displayed in the upper left corner of the screen during BIOS POST with their own BIOS POST logo. Use the congatec system utility CGUTIL 1.5.4 or later to replace or add the OEM POST logo.

6.5.4 OEM BIOS Code/Data

With the congatec embedded BIOS, system designers can add their code to the BIOS POST process. The congatec Embedded BIOS first calls the OEM code before handing over control to the OS loader. Except for custom specific code, this feature can also be used to support verb tables for HDA codecs, PCI/PCIe OpROMs, bootloaders, rare graphic modes and Super I/O controller initialization.



The OEM BIOS code of the new UEFI based firmware is called only when the CSM (Compatibility Support Module) is enabled in the BIOS setup menu. Contact congatec technical support for more information on how to add OEM code.

6.5.5 OEM DXE Driver

This feature allows designers to add their own UEFI DXE driver to the congatec embedded BIOS. Contact congatec technical support for more information on how to add an OEM DXE driver.

6.6 congatec Battery Management Interface

To facilitate the development of battery powered mobile systems based on embedded modules, congatec AG defined an interface for the exchange of data between a CPU module (using an ACPI operating system) and a Smart Battery system. A system developed according to the congatec Battery Management Interface Specification can provide the battery management functions supported by an ACPI-capable operating system (for example, charge state of the battery, information about the battery, alarms or events for certain battery states) without the need for additional modifications to the system BIOS.

In addition to the ACPI-Compliant Control Method Battery mentioned above, the latest versions of the conga-JC370 BIOS and board controller firmware also support LTC1760 battery manager from Linear Technology and a battery only solution (no charger). All three battery solutions are supported on the I2C bus and the SMBus. This gives the system designer more flexibility when choosing the appropriate battery sub-system.

For more information about this subject visit the congatec website and view the following documents:

- congatec Battery Management Interface Specification
- Battery System Design Guide
- conga-SBM³ User's Guide

6.7 API Support (CGOS)

In order to benefit from the above mentioned non-industry standard feature set, congatec provides an API that allows application software developers to easily integrate all these features into their code. The CGOS API (congatec Operating System Application Programming Interface) is the congatec proprietary API that is available for all commonly used Operating Systems such as Win32, Win64, Win CE, Linux.

The architecture of the CGOS API driver provides the ability to write application software that runs unmodified on all congatec CPU modules. All the hardware related code is contained within the congatec embedded BIOS on the module. See section 1.1 of the CGOS API software developers guide, available on the congatec website.

6.8 Thermal and Voltage Monitoring

The cBC monitors the ambient temperature, input voltage and input current of the conga-JC370. The sensors in the CPU monitor the CPU temperature.

6.9 Security Features

The conga-JC370 features a firmware TPM (Intel PTT TPM 2.0) as well as a discrete Infineon SLB9670 TPM 2.0.



To use the discrete TPM module, disable the firmware TPM (fTPM) in the Advanced ->Platform Trust Technology -> fTPM BIOS setup submenu.

6.10 External System Wake Event

The conga-JC370 supports LAN, USB, power,lid, sleep buttons and PCIe driven wake-up events.

7 BIOS Setup Description

The BIOS setup description of the conga-JC370 can be viewed without having access to the module. However, access to the restricted area of the congatec website is required in order to download the necessary tool (CgMlfViewer) and Menu Layout File (MLF).

The MLF contains the BIOS setup description of a particular BIOS revision. The MLF can be viewed with the CgMlfViewer tool. This tool offers a search function to quickly check for supported BIOS features. It also shows where each feature can be found in the BIOS setup menu.

For more information, read the application note "AN42 - BIOS Setup Description" available at www.congatec.com.



If you do not have access to the restricted area of the congatec website, contact your local congatec sales representative.

7.1 Navigating the BIOS Setup Menu

The BIOS setup menu shows the features and options supported in the congatec BIOS. To access and navigate the BIOS setup menu, press the or <F2> key during POST. The right frame displays the key legend. Above the key legend is an area reserved for text messages. These text messages explain the options and the possible impacts when changing the selected option in the left frame.

7.2 BIOS Versions

The BIOS displays the BIOS project name and the revision code during POST, and on the main setup screen. The initial production BIOS for conga-JC370 is identified as JVWLR1xx or JUWLR1xx, where:

- R is the identifier for a BIOS ROM file,
- 1 is the so called feature number and
- xx is the major and minor revision number.

The binary size for JVWL and JUWL is 32 MB.

7.3 Updating the BIOS

BIOS updates are recommended to correct platform issues or enhance the feature set of the module. The conga-JC370 features a congatec/AMI AptioEFI firmware on an onboard flash ROM chip. You can update the firmware with the congatec System Utility. The utility has five versions—UEFI shell, DOS based command line¹, Win32 command line, Win32 GUI, and Linux version.

For more information about “Updating the BIOS” refer to the user’s guide for the congatec System Utility “CGUTLm1x.pdf” on the congatec website at www.congatec.com.



Note

¹. *Deprecated*



Caution

The DOS command line tool is not officially supported by congatec and therefore not recommended for critical tasks such as firmware updates. We recommend to use only the UEFI shell for critical updates.

7.4 Supported Flash Devices



The conga-JC370 supports:

- Winbond W25Q256JVEIQ (32 MB)
- GigaDevice GD25B256DYIG (32 MB)

The flash devices above can be used to support external BIOS. For more information about external BIOS support, refer to the Application Note “AN7_External_BIOS_Update.pdf” on the congatec website at <http://www.congatec.com>.

Our company network supports you worldwide with offices in Germany, Austria, Switzerland, the UK and the USA. For more information please contact:

Headquarters



<p>Germany</p> 		<p>FORTEC Elektronik AG Augsburger Str. 2b 82110 Germering</p>	<p>Phone: +49 89 894450-0 E-Mail: info@fortecag.de Internet: www.fortecag.de</p>
--	---	---	---

Fortec Group Members

<p>Austria</p> 	 <p>A FORTEC GROUP MEMBER</p>	<p>Distec GmbH, Office Vienna Nuschinggasse 12 1230 Wien</p>	<p>Phone: +43 1 8673492-0 E-Mail: info@distec.de Internet: www.distec.de</p>
--	--	---	---

<p>Germany</p> 	 <p>A FORTEC GROUP MEMBER</p>	<p>Distec GmbH Augsburger Str. 2b 82110 Germering</p>	<p>Phone: +49 89 894363-0 E-Mail: info@distec.de Internet: www.distec.de</p>
--	--	--	---

<p>Switzerland</p> 	 <p>A FORTEC GROUP MEMBER</p>	<p>ALTRAC AG Bahnhofstraße 3 5436 Würenlos</p>	<p>Phone: +41 44 7446111 E-Mail: info@altrac.ch Internet: www.altrac.ch</p>
---	---	---	--

<p>United Kingdom</p> 	 <p>A FORTEC GROUP MEMBER</p>	<p>Display Technology Ltd. Osprey House, 1 Osprey Court Hichingbrooke Business Park Huntingdon, Cambridgeshire, PE29 6FN</p>	<p>Phone: +44 1480 411600 E-Mail: info@displaytechnology.co.uk Internet: www.displaytechnology.co.uk</p>
---	--	---	---

<p>USA</p> 	 <p>A FORTEC GROUP MEMBER</p>	<p>Apollo Display Technologies, Corp. 87 Raynor Avenue, Unit 1 Ronkonkoma, NY 11779</p>	<p>Phone: +1 631 5804360 E-Mail: info@apolloDisplays.com Internet: www.apolloDisplays.com</p>
--	--	--	--