



OUR GLOBAL
COMPETENCE
CENTRES

 APOLLO DISPLAY
TECHNOLOGIES



 DISTEC



 DISPLAY
TECHNOLOGY



Manual

iBase

AGS103T

Ultra-Compact IoT Gateway Edge Computing System with Intel® Atom® x6413E/x6211E Processors



The information contained in this document has been carefully researched and is, to the best of our knowledge, accurate. However, we assume no liability for any product failures or damages, immediate or consequential, resulting from the use of the information provided herein. Our products are not intended for use in systems in which failures of product could result in personal injury. All trademarks mentioned herein are property of their respective owners. All specifications are subject to change without notice.

AGS103T

Advanced Gateway & Ultra-Compact Fanless System

User's Manual

Version 1.0
(September 2021)



Copyright

© 2021 IBASE Technology, Inc. All rights reserved.

No part of this publication may be reproduced, copied, stored in a retrieval system, translated into any language or transmitted in any form or by any means, electronic, mechanical, photocopying, or otherwise, without the prior written consent of IBASE Technology, Inc. (hereinafter referred to as "IBASE").

Disclaimer

IBASE reserves the right to make changes and improvements to the products described in this document without prior notice. Every effort has been made to ensure the information in the document is correct; however, IBASE does not guarantee this document is error-free.

IBASE assumes no liability for incidental or consequential damages arising from misapplication or inability to use the product or the information contained herein, nor for any infringements of rights of third parties, which may result from its use.

Trademarks

All the trademarks, registrations and brands mentioned herein are used for identification purposes only and may be trademarks and/or registered trademarks of their respective owners.

Compliance



This product has passed CE tests for environmental specifications and limits. This product is in accordance with the directives of the Union European (EU). If users modify and/or install other devices in this equipment, the CE conformity declaration may no longer apply.



This product has been tested and found to comply with the limits for a Class B device, pursuant to Part 15 of the FCC Rules. These limits are designed to provide reasonable protection against harmful interference in a residential installation. This equipment generates, uses and can radiate radio frequency energy and, if not installed and used in accordance with manufacturer's instructions, may cause harmful interference to radio communications.

WEEE



This product must not be disposed of as normal household waste, in accordance with the EU directive of for waste electrical and electronic equipment (WEEE - 2012/19/EU). Instead, it should be disposed of by returning it to a municipal recycling collection point. Check local regulations for disposal of electronic products.

Green IBASE



This product is compliant with the current RoHS restrictions and prohibits use of the following substances in concentrations exceeding 0.1% by weight (1000 ppm) except for cadmium, limited to 0.01% by weight (100 ppm).

- Lead (Pb)
- Mercury (Hg)
- Cadmium (Cd)
- Hexavalent chromium (Cr6+)
- Polybrominated biphenyls (PBB)
- Polybrominated diphenyl ether (PBDE)

Important Safety Information

Carefully read the precautions before using the device.

Environmental conditions:

- Lay the device horizontally on a stable and solid surface in case the device may fall, causing serious damage.
- Make sure you leave plenty of space around the device for ventilation.
- Use this product in environments with ambient temperatures $-20^{\circ}\text{C} \sim 70^{\circ}\text{C}$.
- Do not leave this device in an environment where the storage temperature may go below -40°C or above 85°C . This could damage the device. The device must be used in a controlled environment.

Care for your iBASE products:

- Before cleaning the device, turn it off and unplug all cables such as power in case a small amount of electrical current may still flow.
- Use neutral cleaning agents or diluted alcohol to clean the device chassis with a cloth. Then wipe the chassis with a dry cloth.
- Vacuum the dust with a computer vacuum cleaner to prevent the air vent or slots from being clogged.



WARNING

Attention during use:

- Do not use this product near water.
- Do not spill water or any other liquids on your device.
- Do not place heavy objects on the top of the device.
- Operate this device from the type of power indicated on the marking label. If you are not sure of the type of power available, consult your distributor or local power company.
- Ensure that you apply correctly the power supply voltage.
- Do not walk on the power cord or allow anything to rest on it.
- If you use an extension cord, make sure that the total ampere rating of the product plugged into the extension cord does not exceed its limits.

Avoid Disassembly

You are not suggested to disassemble, repair or make any modification to the device. Disassembly, modification, or any attempt at repair could generate hazards and cause damage to the device, even bodily injury or property damage, and will void any warranty.



CAUTION

Replace only with the same or equivalent type recommended by the manufacturer. Dispose of used batteries according to the manufacturer's instructions.

Warranty Policy

- **IBASE standard products:**

24-month (2-year) warranty from the date of shipment. If the date of shipment cannot be ascertained, the product serial numbers can be used to determine the approximate shipping date.
- **3rd-party parts:**

12-month (1-year) warranty from delivery for the 3rd-party parts that are not manufactured by IBASE, such as CPU, memory, storage device, power adapter, panel and touchscreen.
- * PRODUCTS, HOWEVER, THAT FAILS DUE TO MISUSE, ACCIDENT, IMPROPER INSTALLATION OR UNAUTHORIZED REPAIR SHALL BE TREATED AS OUT OF WARRANTY AND CUSTOMERS SHALL BE BILLED FOR REPAIR AND SHIPPING CHARGES.

Technical Support & Services

1. Visit the IBASE website at www.ibase.com.tw to find the latest information about the product.
2. If you need any further assistance from your distributor or sales representative, prepare the following information of your product and elaborate upon the problem.
 - Product model name
 - Product serial number
 - Detailed description of the problem
 - The error messages in text or in screenshots if there is any
 - The arrangement of the peripherals
 - Software in use (such as OS and application software, including the version numbers)
3. If repair service is required, you can download the RMA form at <http://www.ibase.com.tw/english/Supports/RMAService/>. Fill out the form and contact your distributor or sales representative.

Table of Contents

Chapter 1	General Information	1
1.1	Introduction	2
1.2	Features	2
1.3	Packing List	3
1.4	Optional Accessories	3
1.5	Specifications	4
1.6	Product View – AGS103T	6
1.7	Dimensions –AGS103T	9
1.8	Dimensions –AGS103TS	9
Chapter 2	Hardware Configuration	10
2.1	Installations	11
2.1.1	Memory Installation / Replacement	11
2.1.2	Mini-PCIe & M.2 Cards Installation / Replacement	12
2.1.3	WiFi / 3G / 4G Antenna Installation	12
2.1.4	Mounting Installation	13
2.1.5	HDD Module Installation	14
2.1.6	SIM Card Installation	15
2.1.7	Pinout for COM Ports, DC-In Power & Line-Out Jack	16
2.2	Setting the Jumpers	19
2.3	Motherboard Jumper & Connector Locations	20
2.4	SL100 Motherboard Jumpers and Connectors	22
2.4.1	SW1: Power Button Switch	22
2.4.2	RTC RST# (SW2-1) & SRTC RST# (SW2-2)	22
2.4.3	DVI-I Connector (CN1)	23
2.4.4	HDMI Connector (CN2)	23
2.4.5	Gigabit LAN RJ45 Connector (CN3)	23
2.4.6	Gigabit LAN RJ45 Connectors (CN4)	24
2.4.7	Dual USB 3.1 Connector (CN5)	24
2.4.8	Dual USB 2.0 Connector (CN6)	24
2.4.9	Line-Out / Line-In Connector (CN7)	25
2.4.10	COM1 Connector (CN8)	25
2.4.11	SATA Connector (CN9)	25
2.4.12	COM2 Connector (CN10)	26
2.4.13	AT/ATX Mode (JP1)	26
2.4.14	Reset Button Connector (J1)	27
2.4.15	J2: DC-In Power Connector (3-pin terminal block)	27

2.4.16	J3: RTC Battery Connector.....	28
2.4.17	J4: SPI Firmware Header	28
2.4.18	J5: DDR4 Socket.....	28
2.4.19	J6: SATA Power Connector	29
2.4.20	J7: Mini PCIe Socket (Supports USB & SIM1)	29
2.4.21	J8: Mini PCIe Socket (Supports USB, PCIe & SIM2)	30
2.4.22	J9(SIM1), J12(SIM2): SIM Socket.....	30
2.4.23	J10: Power IC JTAG	30
2.4.24	J11 : Board-to-Board Connector	31
2.4.25	J13 : M.2 B-Key Socket (Supports SATA / PCIe /USB)	33
2.4.26	J14 : Port 80 Header	33
2.4.27	LED1: Power_Fail (Red).....	33
2.4.28	LED2: Heartbeat (Blue)	33
2.4.29	LED3: WWAN1 (Green).....	33
2.4.30	LED4: WWAN2 (Green).....	33
Chapter 3 Driver Installation		34
3.1	Introduction	35
3.2	Intel® Chipset Software Installation Utility.....	35
3.3	Graphics Driver Installation	37
3.4	HD Audio Driver Installation	39
3.5	Intel® ME Drivers Installation	40
3.6	LAN Driver Installation	42
Chapter 4 BIOS Setup.....		44
4.1	Introduction	45
4.2	BIOS Setup.....	45
4.3	Main Settings	46
4.4	Advanced Settings	47
4.5	Chipset Settings.....	59
4.6	Security Settings	61
4.7	Boot Settings.....	65
4.8	Save & Exit Settings.....	66
Appendix		67
A.	I/O Port Address Map.....	68
B.	Interrupt Request Lines (IRQ)	70
C.	Watchdog Timer Configuration.....	71

Chapter 1

General Information

The information provided in this chapter includes:

- Features
- Packing List
- Optional Accessories
- Specifications
- Product View
- Dimensions

1.1 Introduction

The AGS103T embedded computer is an ultra-compact fanless system AGS103T integrating the Intel Atom® x6000E Series processors (code-named Elkhart Lake) that deliver up to 4 cores with 40% increase in CPU performance and improved graphics when compared with previous versions. Based on the economical 10nm technology, the low-power platform is suitable for embedded applications in factory automation, IoT gateway, and automatic control systems.



AGS103T

1.2 Features

- Ultra-Compact, rugged and fanless system with Intel® Atom™ x6413E/x6211E series processor
- Over/Under/Reverse voltage protection
- 9V~36V DC wide-range power input
- Display output through HDMI and DVI-I
- DIN-rail mount & Wall mount compatibility
- GPIO 4-in & 4-out with isolation function
- 3 x Gigabit Ethernet
- 3 x full-size Mini PCI-E sockets, 1x 3042/2242 M.2 B-Key, TPM 2.0

1.3 Packing List

Your product package should include the items listed below. If any of the items below is missing, contact the distributor or the dealer from whom you purchased the product.

- AGS103T / AGS103TS x 1
- Wall Mount Kit x 1
- Round Head Screw (for Wall Mount Kit) x 4
- Thermal Pad
- 19 x 19 x 2 mm x 1
- 28 x 18 x 2 mm x 1
- DIN Rail Bracket x 1

1.4 Optional Accessories

IBASE provide optional accessories as follows. Please contact us or your dealer if you need any.

- DC-In Power Adapter
- Power Cord
- WiFi Antenna Kit
- 4G/LTE or GPS Antenna Kit

1.5 Specifications

Product Name	AGS103T	AGS103TS
System		
Motherboard	SL100	
Carrier Board	IP802	
Operating System	<ul style="list-style-type: none"> • Windows10 (64-bit) • Linux Ubuntu 	
CPU	Intel® Atom™ QC x6413E Intel® Atom™ DC x6211E	
CPU Speed	Up to 3.0 GHz	
Memory	1 x DDR4-3200 SO-DIMM, expandable to 16 GB (Non-ECC)	
Storage	<ul style="list-style-type: none"> • 1 slot for M.2 B3042 SSD 	<ul style="list-style-type: none"> • 1 slot for M.2 B3042 SSD • 1 slot for 2.5" SSD
Super I/O	Fintek F81964D-I	
Audio Codec	Realtek ALC888S	
Network	3 x Intel® I210IT GbE LAN	
Power Supply	DC-In 9V ~ 36V (3-pin terminal block)	
BIOS	AMI BIOS	
Watchdog	Watchdog Timer 256 segments, 0, 1, 2...255 sec/min	
TPM	2.0	
Chassis	Aluminum & steel, silver	
Mounting	<ul style="list-style-type: none"> • Desktop mount / Wall mount (wall mount kit included) • DIN rail mount 	
Dimensions (W x H x D)	190 x 52 x 110 mm	190 x 68 x 110 mm
Weight	1.1 kg	1.25 kg
Certificate	CE / LVD / FCC Class B (pre-scan)	

I/O Ports	
Left External I/O	<ul style="list-style-type: none"> • 2 x RS232/422/485 port: COM1 & COM2, select from BIOS • 1 x Antenna hole for WLAN module • 1 x Speaker-out / Mic-in connector
Right External I/O	<ul style="list-style-type: none"> • 1 x Antenna hole for WLAN module • 2 x Nano SIM card slot * The socket signal is from the Mini-PCIe 4G/LTE card.
Rear External I/O	<ul style="list-style-type: none"> • 1 x DVI-I • 1 x HDMI • 2 x USB 3.1 • 2 x USB 2.0 • 3 x RJ45 GbE LAN port • 4 x LED indicators (WLAN, WWAN, Heartbeat, Power/troubleshooting) • 1 x power button • 1 x 3-pin DC-in terminal block type for 9V-36V • 2 x Antenna hole for WLAN module • 2 x RS-232/422/485 port: COM3 & COM4 • 1 x Isolated 4-In & 4-Out GPIO connector
Expansion slots	<ul style="list-style-type: none"> • 1 x full-size Mini-PCIe socket with USB 2.0 • 2 x full-size Mini-PCIe socket with USB 2.0 & PCIe • 1 x M.2 B3042 socket with USB 2.0 & SATA for WWAN & SSD • 1 x 2.5" SSD slot (for AGS103TS only)
Environment	
Temperature	<ul style="list-style-type: none"> • Operating: -20°C ~ 70°C (-4°F ~ 158°F) • Storage: -40°C ~ 85°C (-40°F ~ 185°F)
Relative Humidity	5 ~ 90% at 45°C (non-condensing)
Vibration	With IEC 60068-2-64 <ul style="list-style-type: none"> • Operating: 2 Grms / 5 ~ 500 Hz (Random operation) • Non-operating: 3 Grms / 5 ~ 500Hz (Random operation)
Shock	With MIL-STD-810G <ul style="list-style-type: none"> • Operating: 30 g / 11 ms duration • Non-operating: 40 g / 11 ms duration

All specifications are subject to change without prior notice.

1.6 Product View – AGS103T

Front View

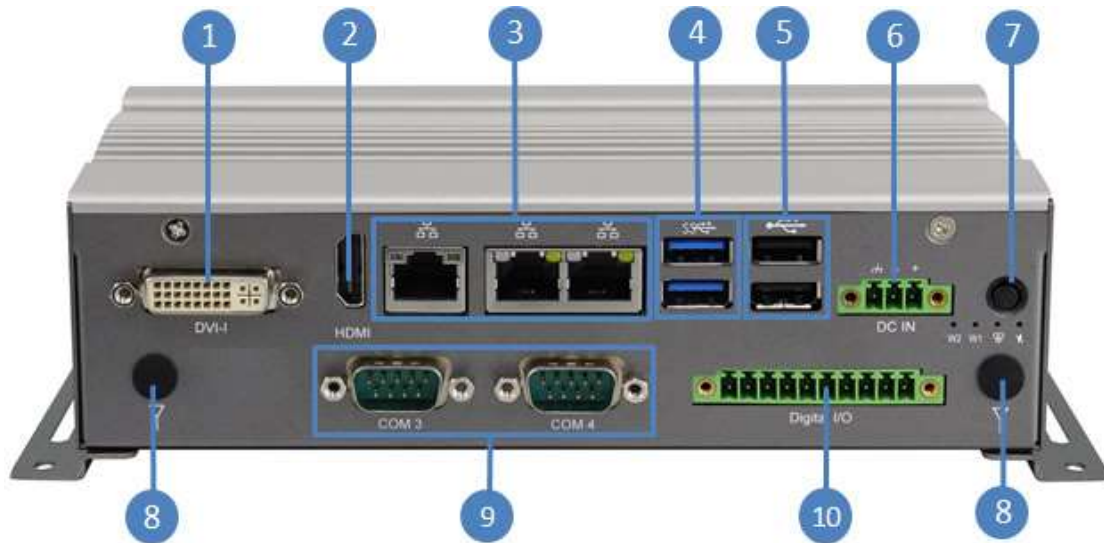

No.	Name	No.	Name
1	CN1: DVI-I Port	6	DC In
2	CN2: HDMI Port	7	DC In Power Input
3	Gigabit LAN Ports	8	Antenna Holes
4	CN5: USB 3.1 Ports	9	COM3/COM4 Ports
5	CN6: USB 2.0 Ports	10	Digital I/O

Oblique View



Remarks: Two Nano SIM card slots are located on the right side.

Side View



Remarks: Aside from the antenna hole, the picture above shows the following:

CN7 : 2 in 1 Audio Jack (Line-out/Line-in)

CN8 : COM1 Connector

CN10 : COM2 Connector

Bottom View



Remarks: For AGS103TS, the bottom has a compartment for a 2.5" SSD slot.

AGS103TS with Wall Mount Brackets



AGS103TS with DIN Rail Mount (Optional)



1.7 Dimensions –AGS103T

Unit: mm

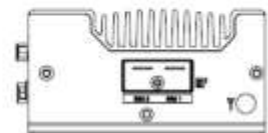
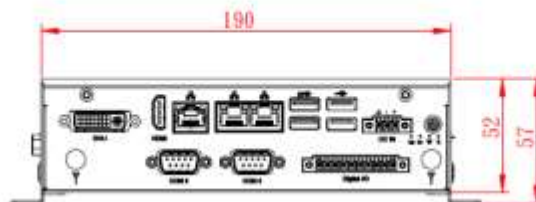
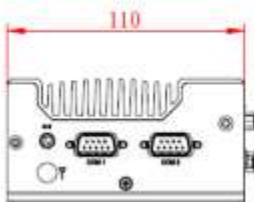
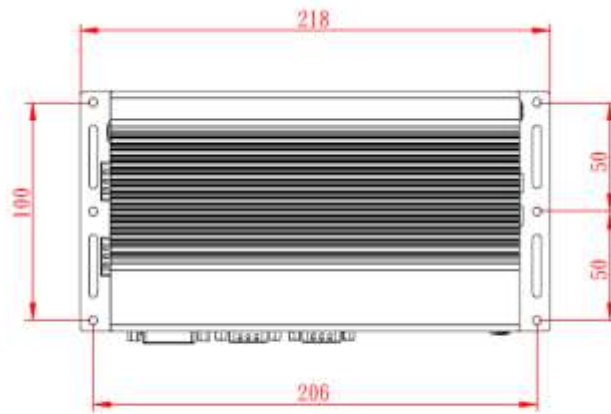

1.8 Dimensions –AGS103TS

Unit: mm

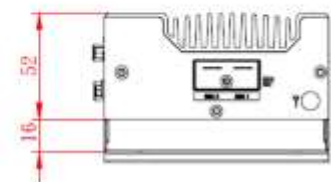
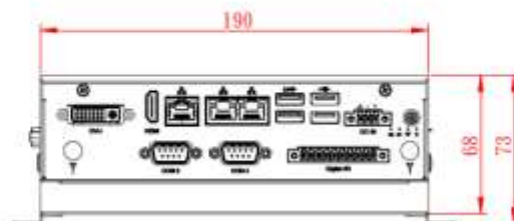
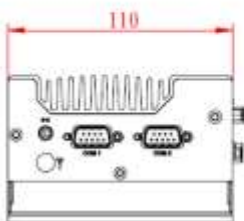
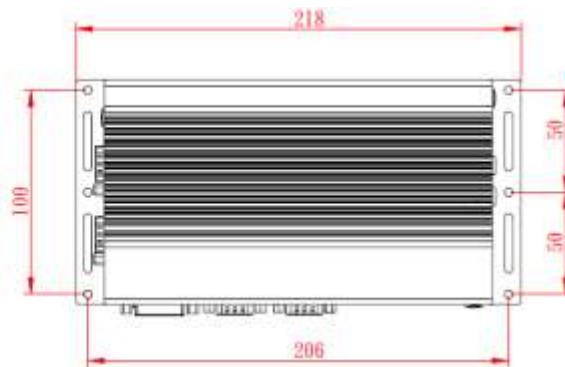

Chapter 2

Hardware Configuration

The information provided in this chapter includes:

- Installations
- Information and locations of connectors

2.1 Installations

Turn your product upside down and take away the device bottom cover by removing 6 screws as indicated below for the installation or replacement of the memory module, mSATA SSD or WLAN card. After installations, secure the device bottom cover back.

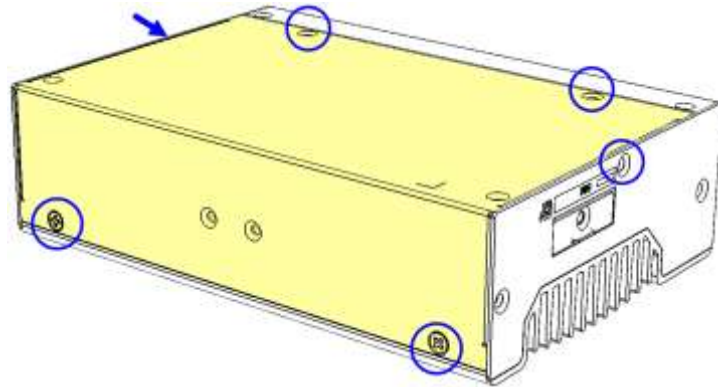

2.1.1 Memory Installation / Replacement

If you need to install or replace a memory module, follow the instructions below for installation after you disassemble the device cover.

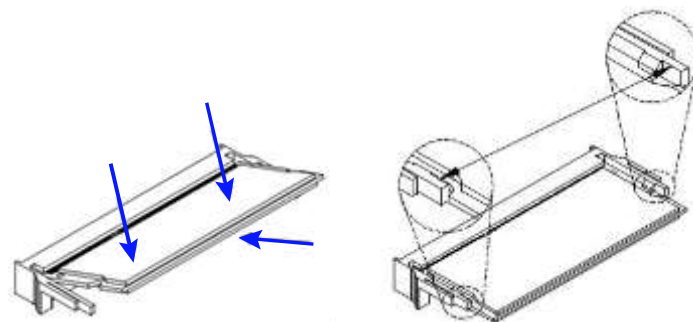

1. Align the key of the memory module with that on the memory slot and insert the module slantwise.
2. Gently push the module in an upright position until the clips of the slot close to hold the module in place when the module touches the bottom of the slot.

To remove the module, press the clips outwards with both hands, and the module will pop-up.

2.1.2 Mini-PCle & M.2 Cards Installation / Replacement

After removing the bottom cover, follow the instructions below.

1. Locate the mini-PCle or M.2 slot, align the key of the card to the interface, and insert the card slantwise.

Mini-PCle card:

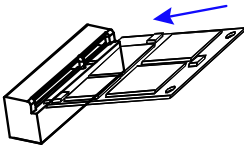

M.2 card:

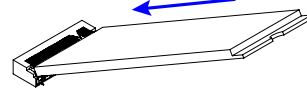

2. Push the card down and fix it with the supplied 2 flat head screws for the mini-PCle card and with one screw for M.2 card.

Mini-PCle card:

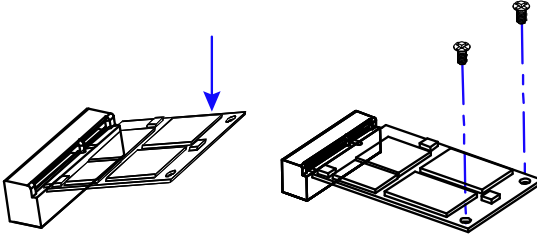

M.2 card:

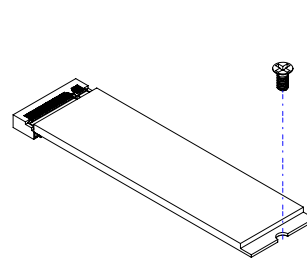

2.1.3 WiFi / 3G / 4G Antenna Installation

Thread the WiFi / 3G / 4G antenna extension cable through an antenna hole of the front I/O cover and fasten the antenna as shown below. Then apply adhesive to the edge of the hex nut behind the front I/O cover to prevent the extension cable from falling if the cable becomes loose.

1. Thread and fasten the hex nut and the washer. Then install the antenna.

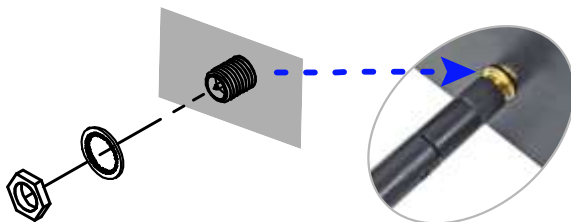

2. Apply adhesive around here.

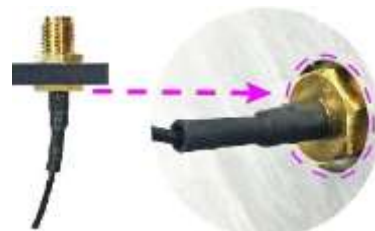

Info: The diameter of the nut is around 6.35 mm (0.25"-36UNC).

2.1.4 Mounting Installation

Requirements

Before mounting the system, ensure that you have enough room for power and signal cable routing, and have good ventilation for the power adaptor. The method of mounting must be able to support the weight of the device plus the weight of the suspending cables to be attached to the system. Use the following methods for mounting your system:

2.1.4.1. Wall-Mounting Installation

1. Turn your product upside down to attach the mounting brackets to your product and secure with the supplied 4 screws.

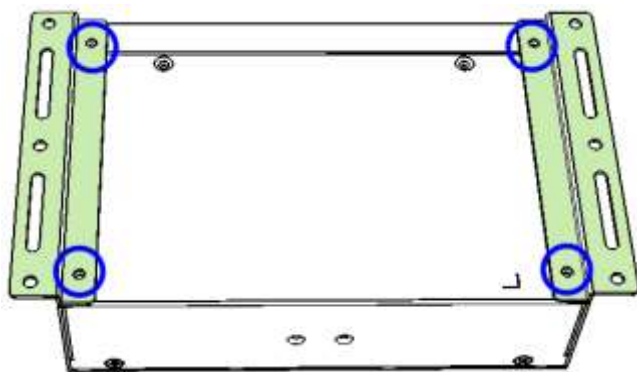

2. Prepare at least 4 screws (M3) to install the device on wall.

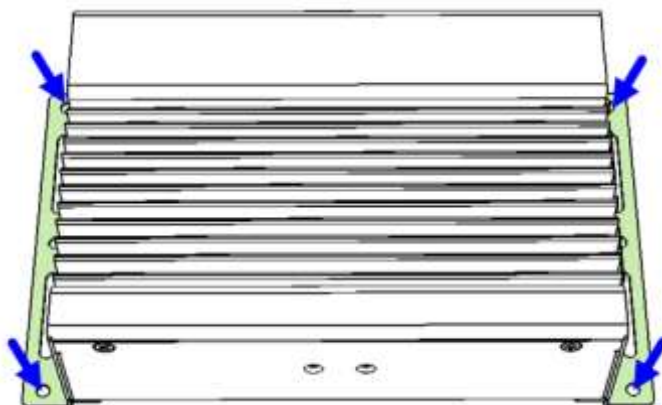

2.1.4.2. DIN Rail Mounting Installation (Optional)

1. Attach the DIN rail mounting bracket to your product, and secure with the supplied 2 screws.

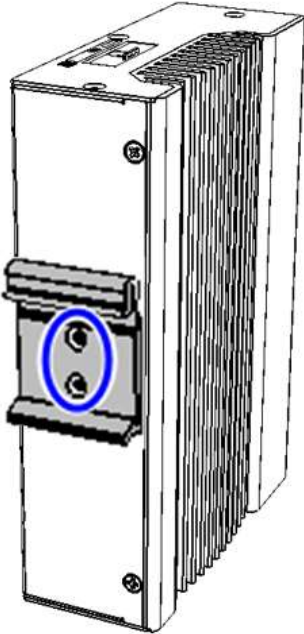

2. Hook the DIN rail mounting bracket over the top of the DIN rail, and then press the lower section of the bracket towards the DIN rail to clip the bracket onto it.

2.1.5 HDD Module Installation

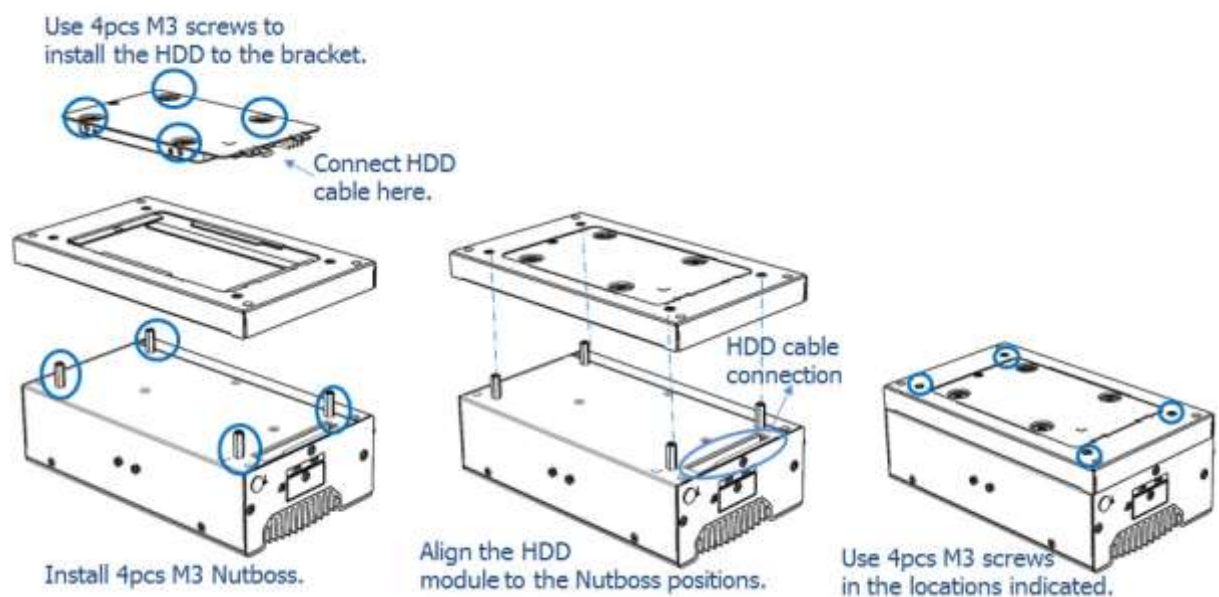

2.1.6 SIM Card Installation

1. The SIM card socket design is push-in/push-out type. To install or remove a SIM card, remove the SIM card cover, as shown in the picture below, by releasing the M3 screw. After insertion/removal of the SIM card, replace the SIM card cover and lock it back into place.

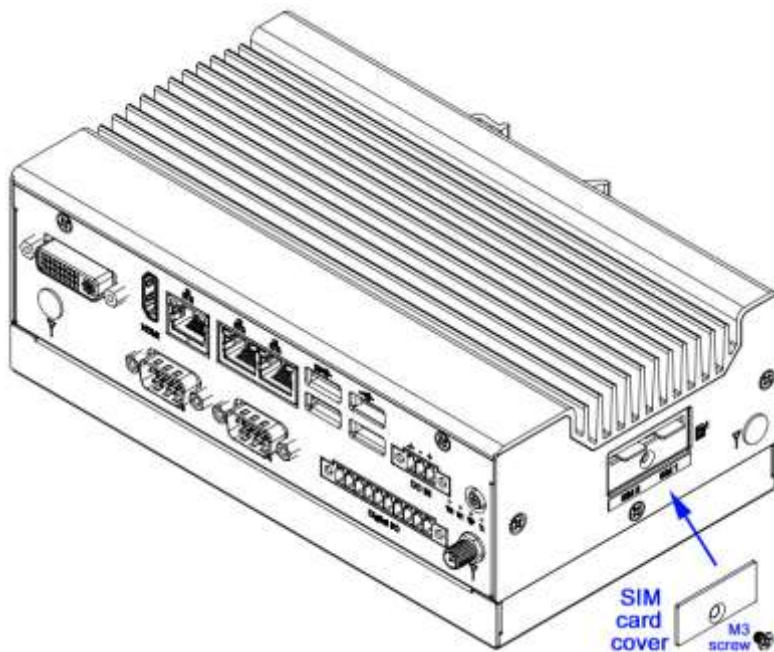

2.1.7 Pinout for COM Ports, DC-In Power & Line-Out Jack

COM1 & COM2 RS232/422/485 Ports

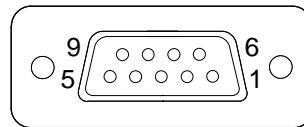

COM1 and COM2 ports are jumper-less and configurable in BIOS.

Pin	Assignment		
	RS-232	RS-422	RS-485
1	DCD, Data carrier detect	TX-	DATA-
2	RXD, Receive data	TX+	DATA+
3	TXD, Transmit data	RX+	NC
4	DTR, Data terminal ready	RX-	NC
5	Ground	Ground	Ground
6	DSR, Data set ready	NC	NC
7	RTS, Request to send	NC	NC
8	CTS, Clear to send	NC	NC
9	RI, Ring indicator	NC	NC

RS-232 COM3 & COM4 Ports

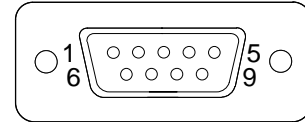
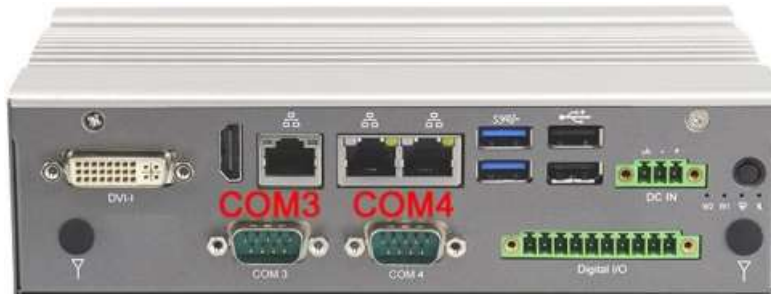

Pin	Assignment		
	RS-232	RS-422	RS-485
1	DCD, Data carrier detect	TX-	DATA-
2	RXD, Receive data	TX+	DATA+
3	TXD, Transmit data	RX+	NC
4	DTR, Data terminal ready	RX-	NC
5	Ground	Ground	Ground
6	DSR, Data set ready	NC	NC
7	RTS, Request to send	NC	NC
8	CTS, Clear to send	NC	NC
9	RI, Ring indicator	NC	NC

J2 DC-In Power Connector (3-pin terminal block)

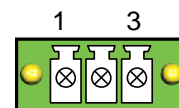

Pin	Assignment
1	Power Ground
2	Case Ground
3	9V ~ 36V

Isolated 4-In & 4-Out GPIO Connector (10-pin terminal block)

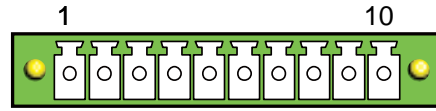

Pin	Assignment	Pin	Assignment
1	Isolation +5V	6	OUT0
2	IN0	7	OUT1
3	IN1	8	OUT2
4	IN3	9	OUT3
5	IN4	10	Isolation Ground

Line-Out / Line-In Jack



This connector supports Line-in and Line-out. Line-out supports a 2W speaker. Please see diagram below.

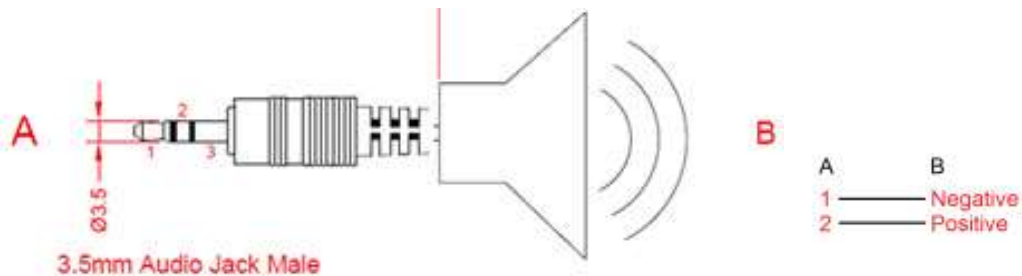

2.2 Setting the Jumpers

Set up and configure your device by using jumpers for various settings and features according to your needs and applications. Contact your supplier if you have doubts about the best configuration for your use.

2.2.1 How to Set Jumpers

Jumpers are short-length conductors consisting of several metal pins with a non-conductive base mounted on the circuit board. Jumper caps are used to have the functions and features enabled or disabled. If a jumper has 3 pins, you can connect either PIN1 to PIN2 or PIN2 to PIN3 by shorting.

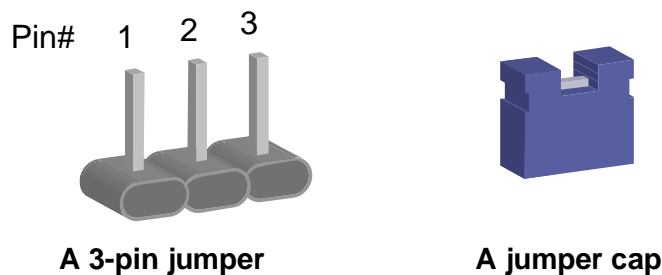

Refer to the illustration below to set jumpers.

Pin closed	Oblique view	Illustration in the manual
Open		
1-2		
2-3		

When two pins of a jumper are encased in a jumper cap, this jumper is **closed**, i.e. turned **On**.

When a jumper cap is removed from two jumper pins, this jumper is **open**, i.e. turned **Off**.

2.3 Motherboard Jumper & Connector Locations

SL100 Motherboard

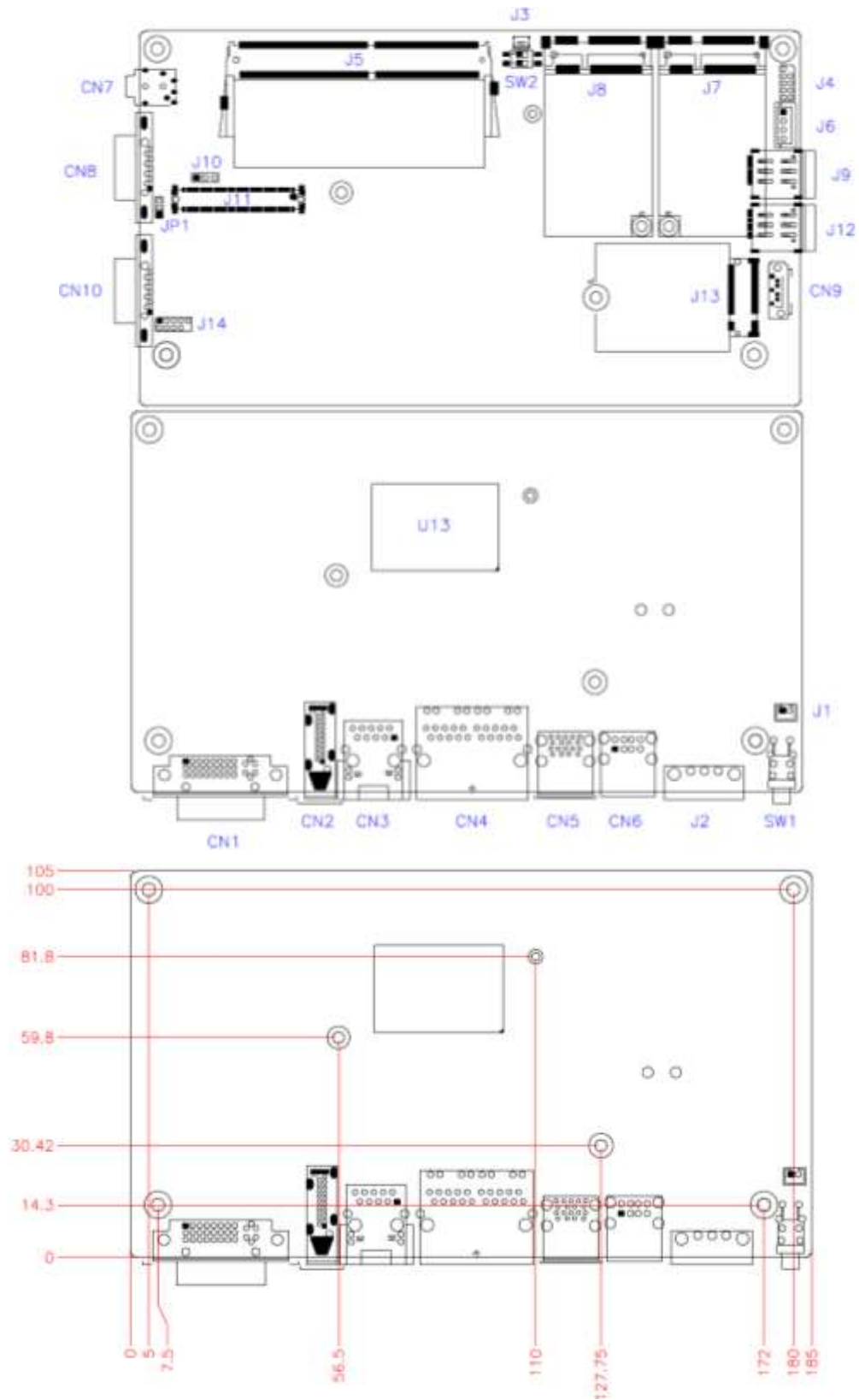

IP802 Carrier Board

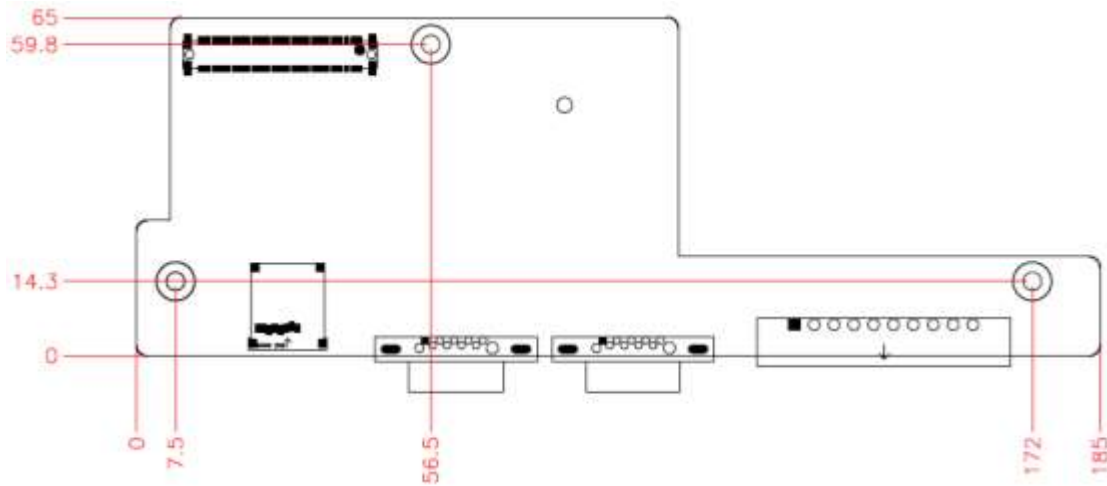
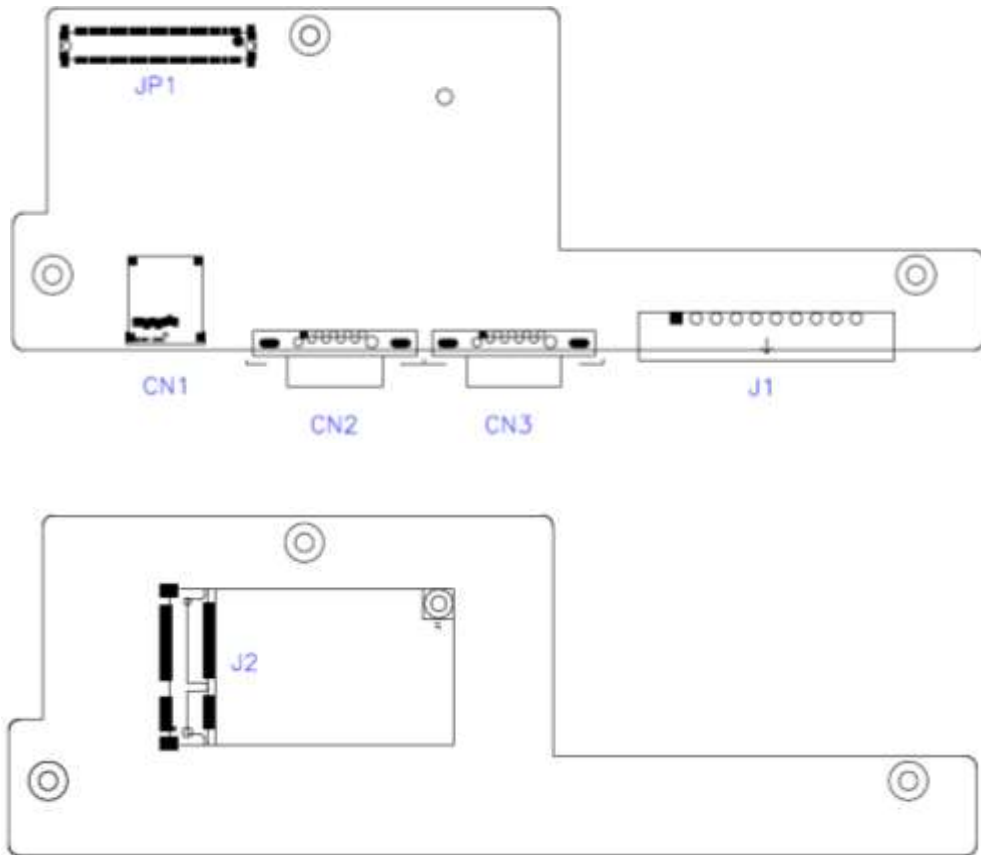

2.4 SL100 Motherboard Jumpers and Connectors

2.4.1 SW1: Power Button Switch

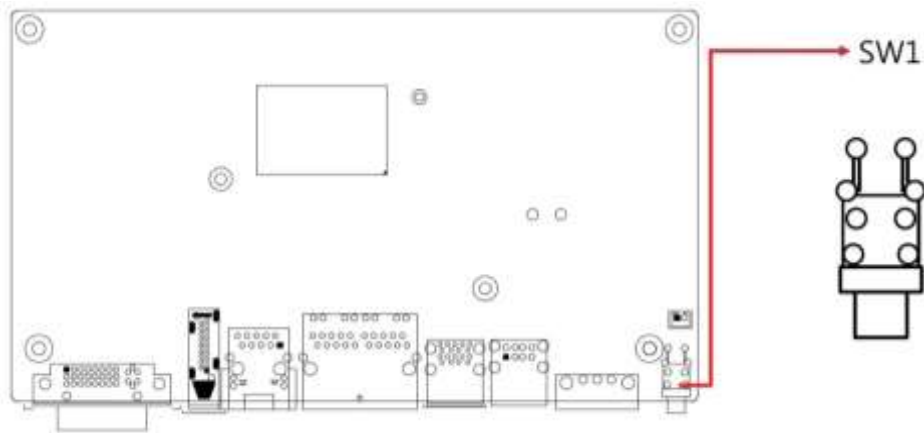

2.4.2 RTC RST# (SW2-1) & SRTC RST# (SW2-2)

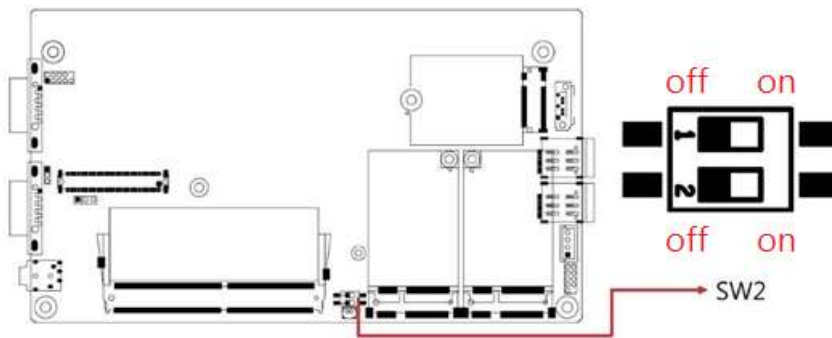

RTC RST# (SW2-1)

Function	Setting
Normal	OFF
Clear CMOS	ON

SRTC RST# (SW2-2)

Function	Setting
Normal	OFF
Clear ME RTC Register	ON

2.4.3 DVI-I Connector (CN1)

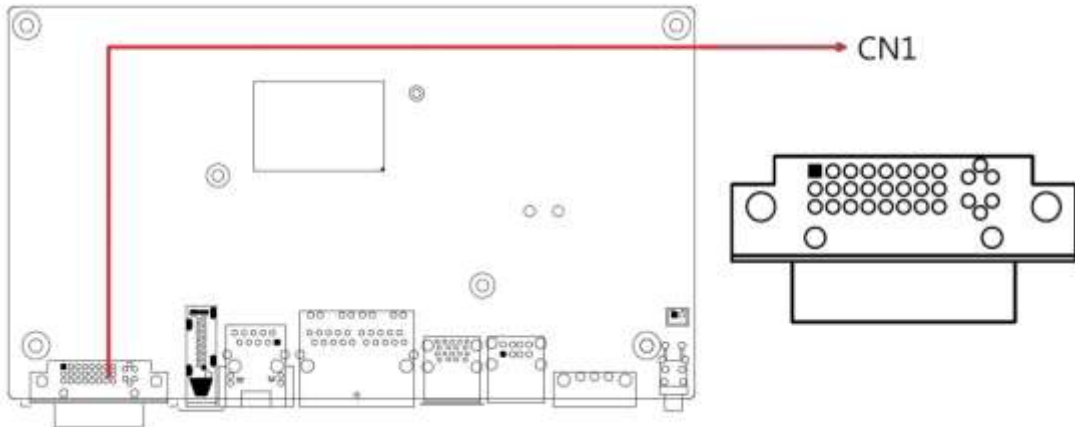

2.4.4 HDMI Connector (CN2)

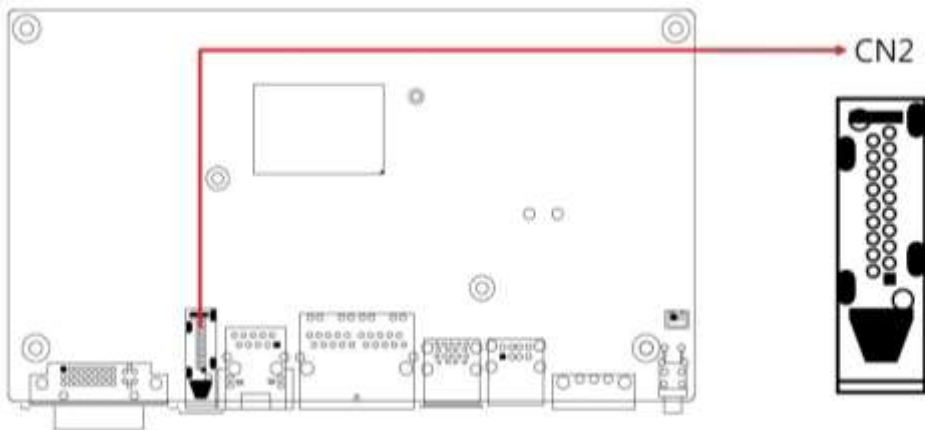

2.4.5 Gigabit LAN RJ45 Connector (CN3)

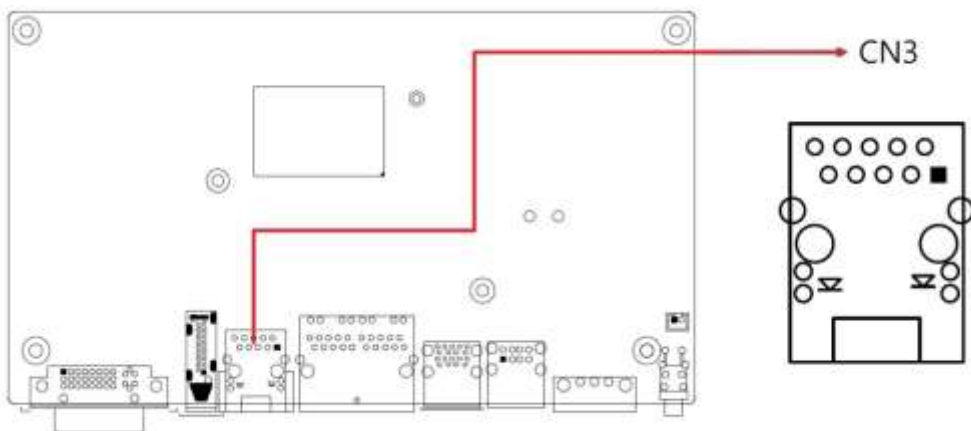

2.4.6 Gigabit LAN RJ45 Connectors (CN4)

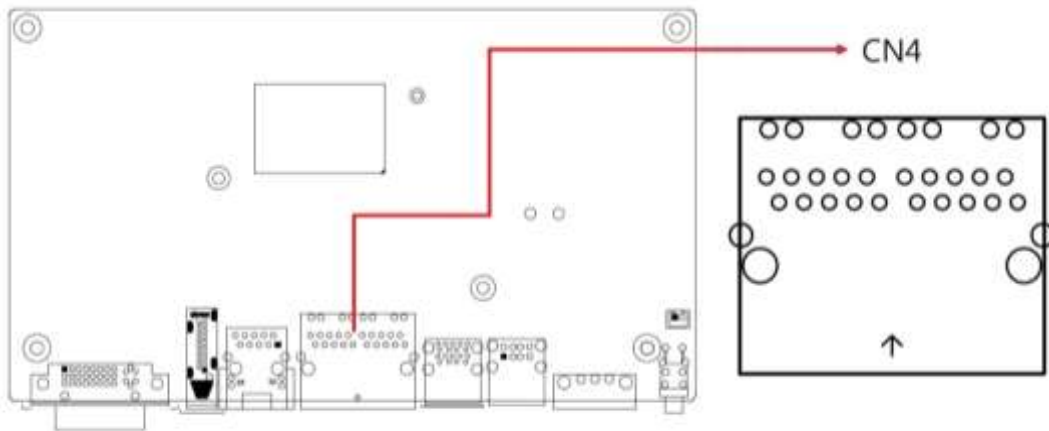

2.4.7 Dual USB 3.1 Connector (CN5)

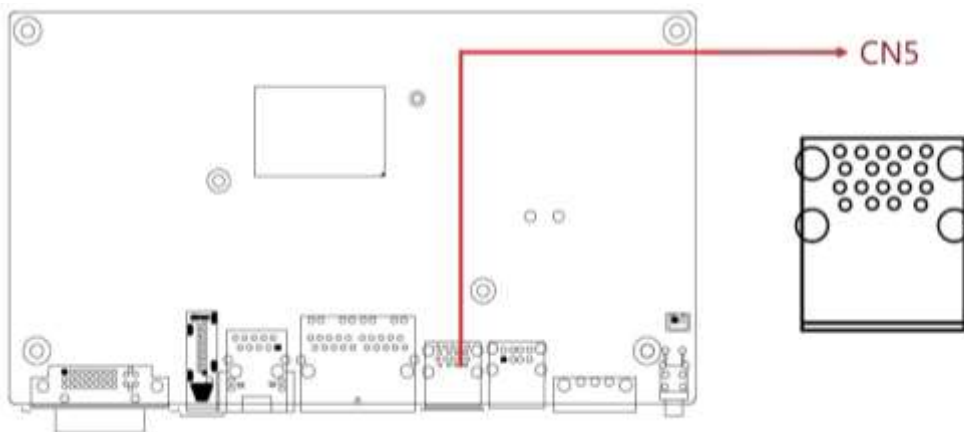

2.4.8 Dual USB 2.0 Connector (CN6)

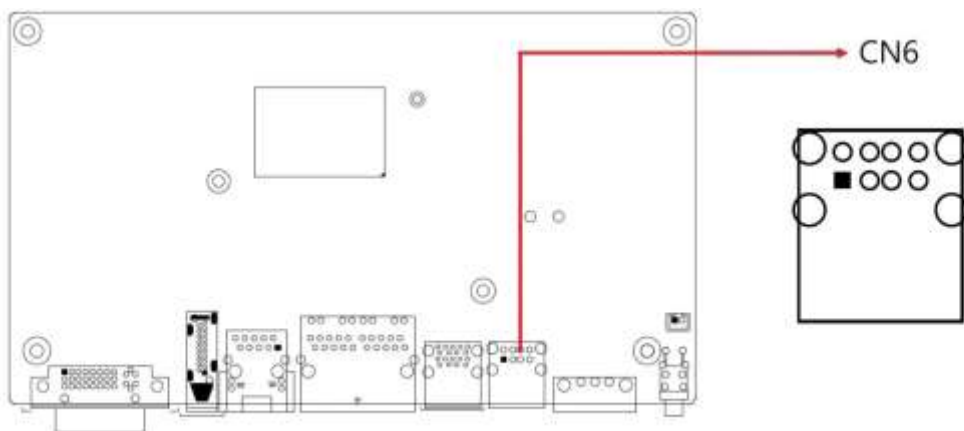

2.4.9 Line-Out / Line-In Connector (CN7)

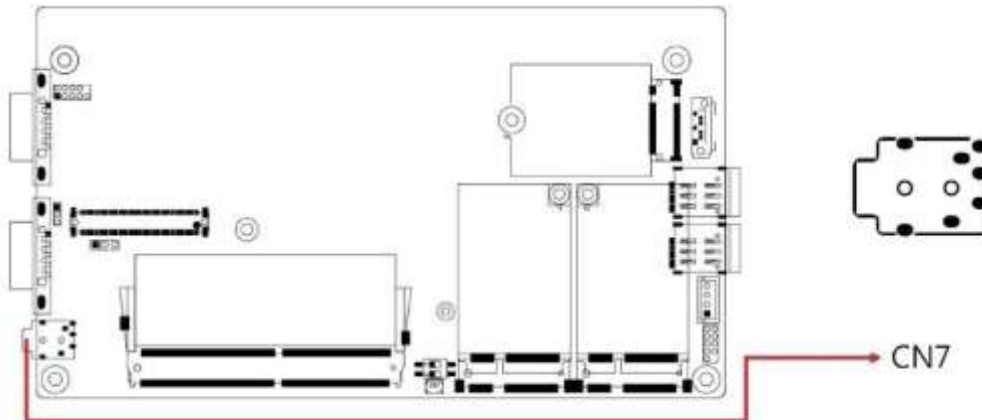

2.4.10 COM1 Connector (CN8)

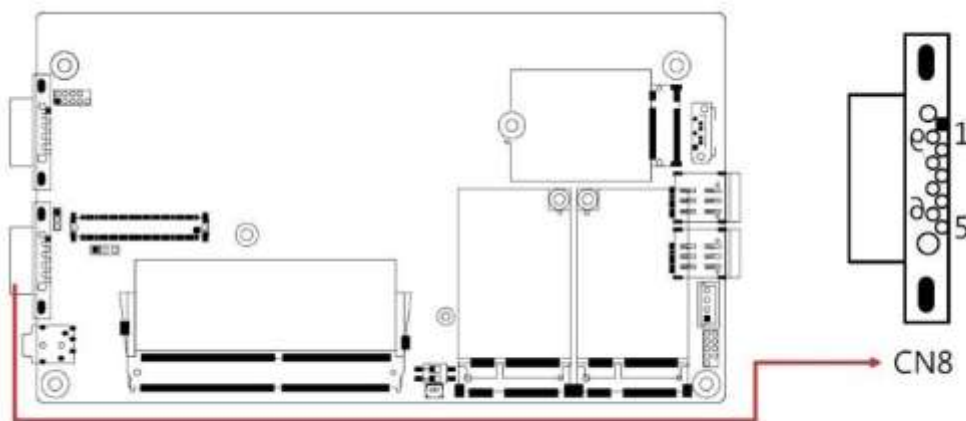

2.4.11 SATA Connector (CN9)

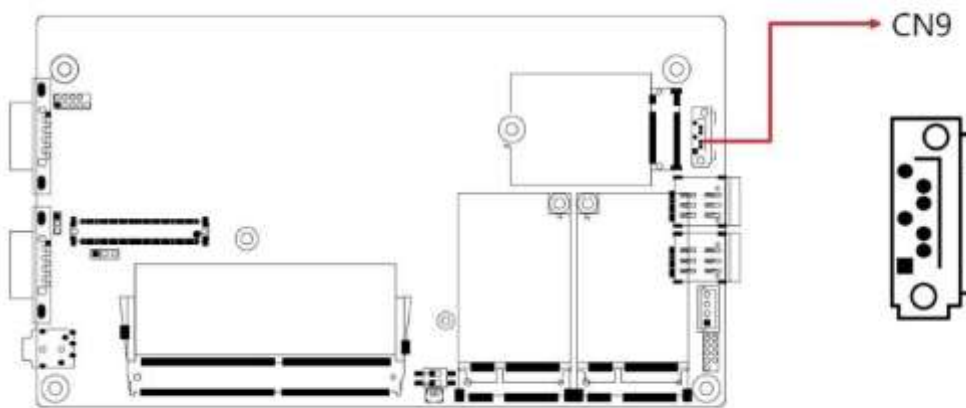

2.4.12 COM2 Connector (CN10)

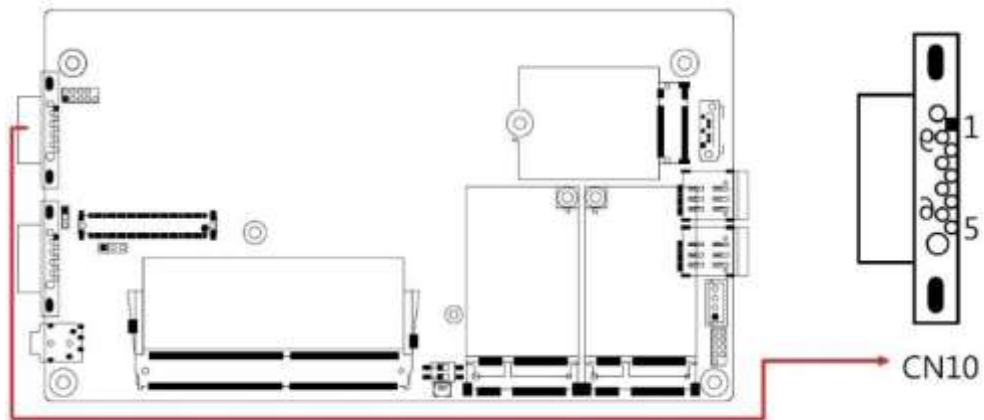

2.4.13 AT/ATX Mode (JP1)

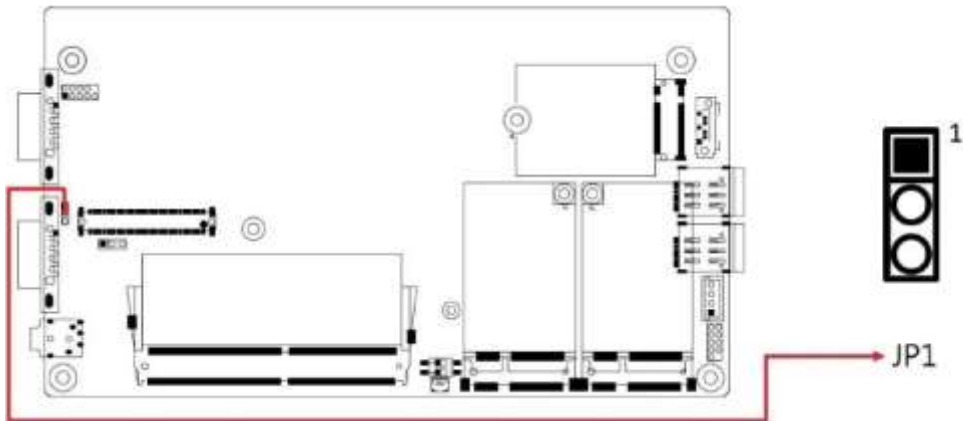

Function	Pin closed	Illustration
ATX (default)	1-2	1
AT	2-3	1

2.4.14 Reset Button Connector (J1)

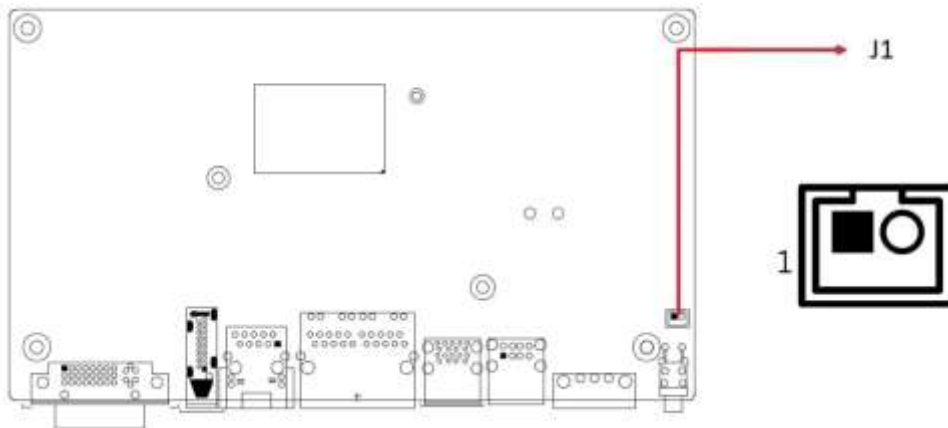

Pin	Assignment
1	Ground
2	Reset BTN

2.4.15 J2: DC-In Power Connector (3-pin terminal block)

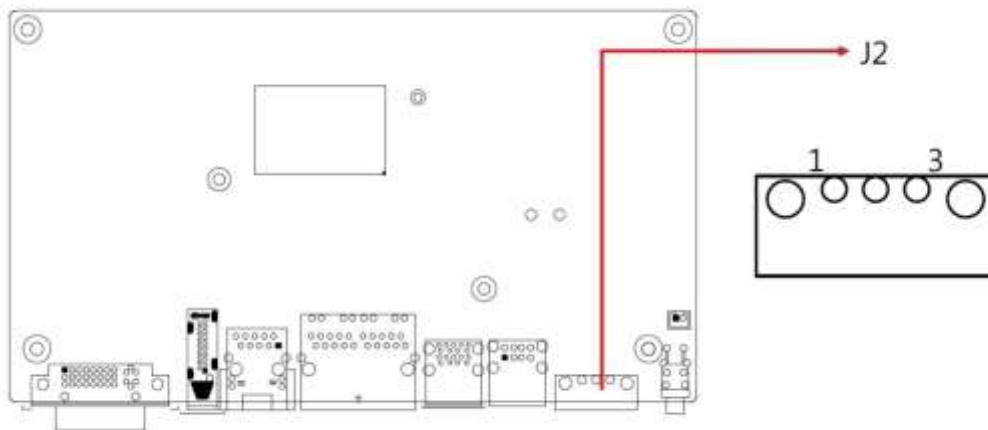

2.4.16 J3: RTC Battery Connector

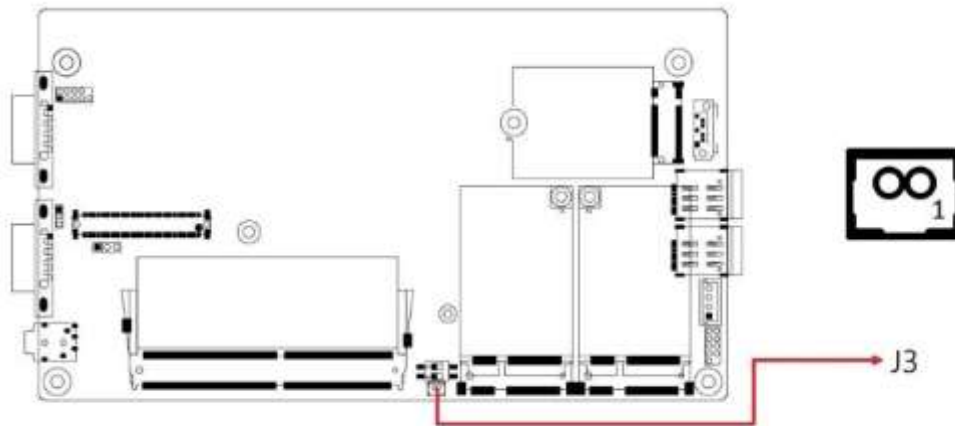

2.4.17 J4: SPI Firmware Header

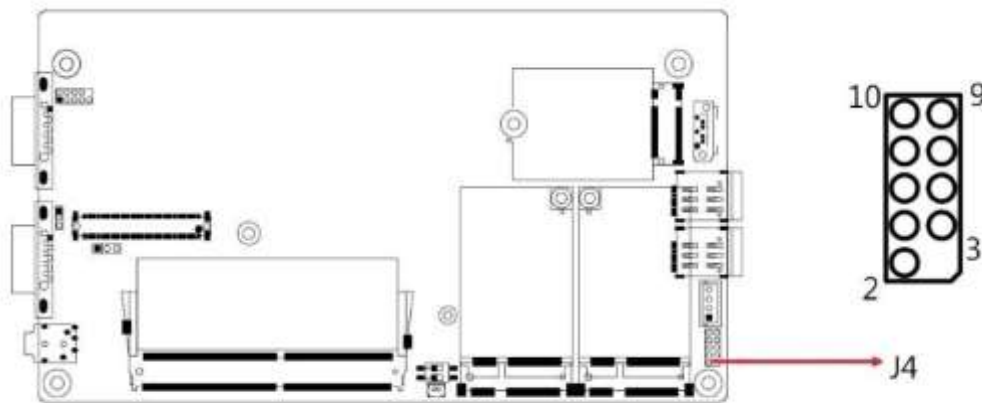

2.4.18 J5: DDR4 Socket

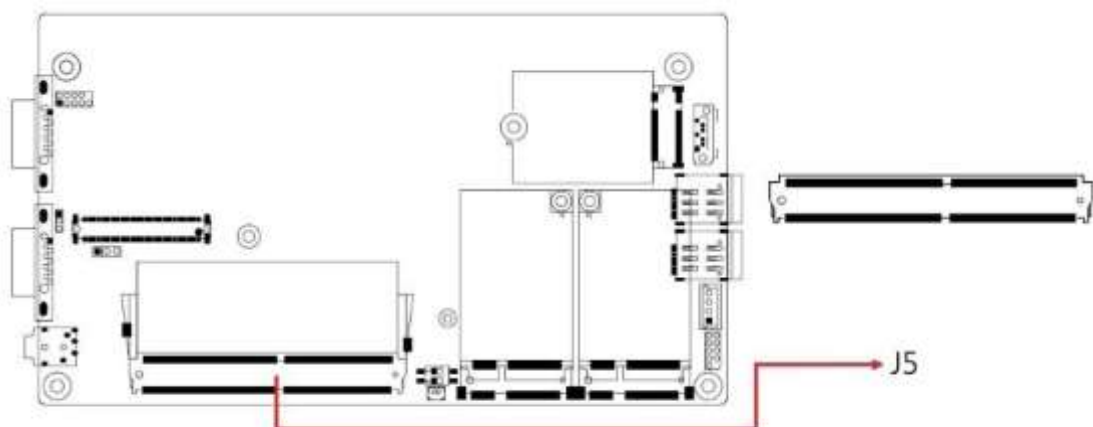

2.4.19 J6: SATA Power Connector

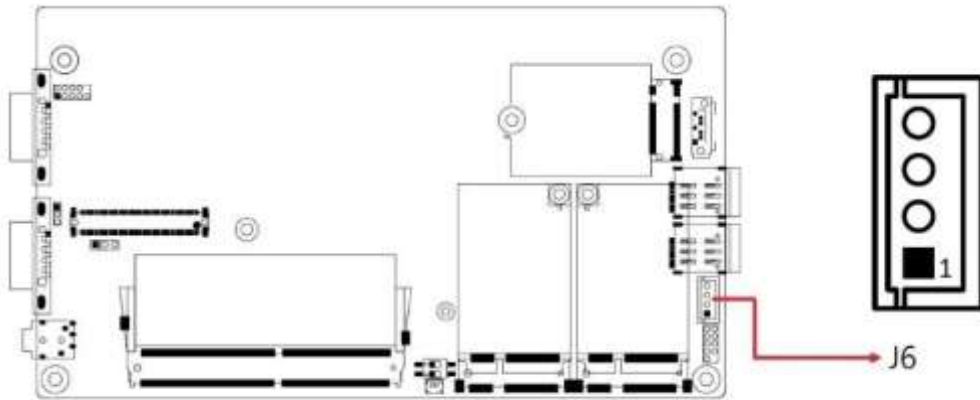

Pin	Assignment
1	5V
2	GND
3	GND
4	X

2.4.20 J7: Mini PCIe Socket (Supports USB & SIM1)

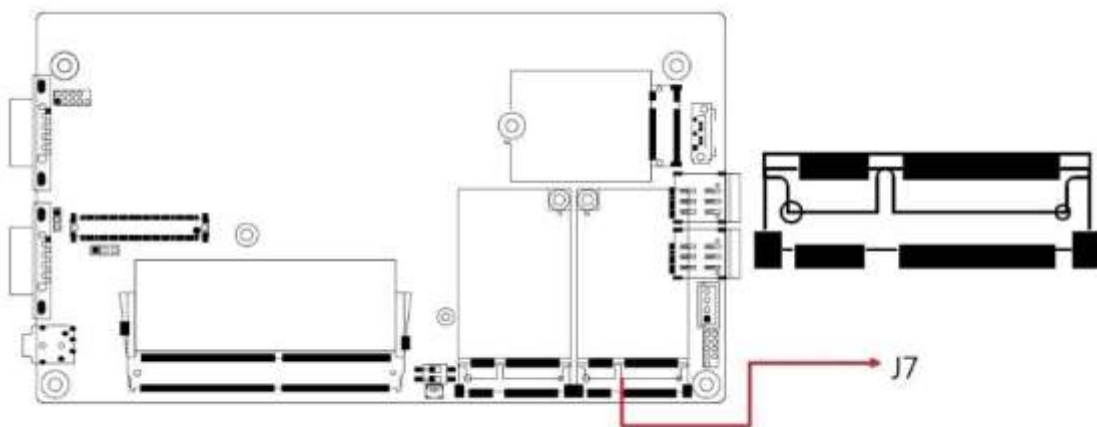

2.4.21 J8: Mini PCIe Socket (Supports USB, PCIe & SIM2)

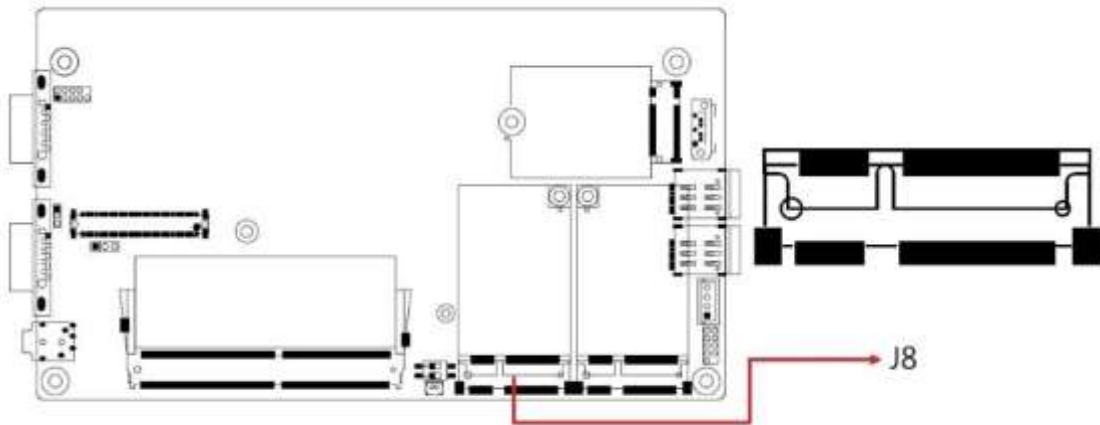

2.4.22 J9(SIM1), J12(SIM2): SIM Socket

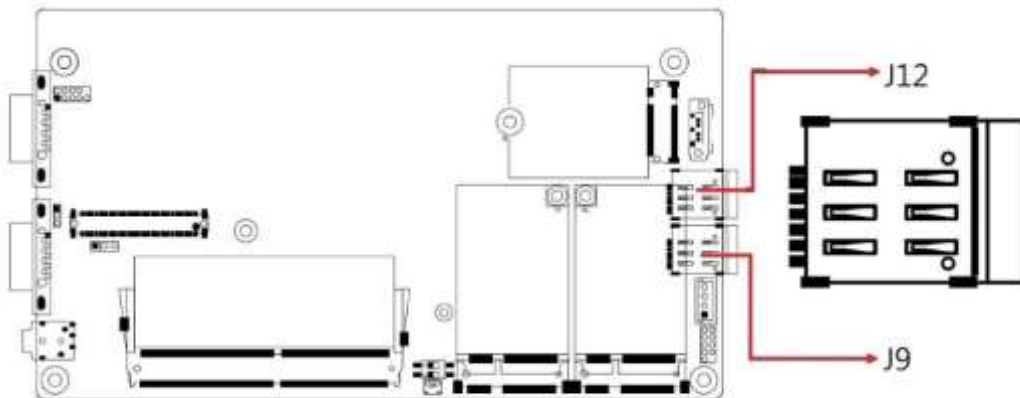

2.4.23 J10: Power IC JTAG

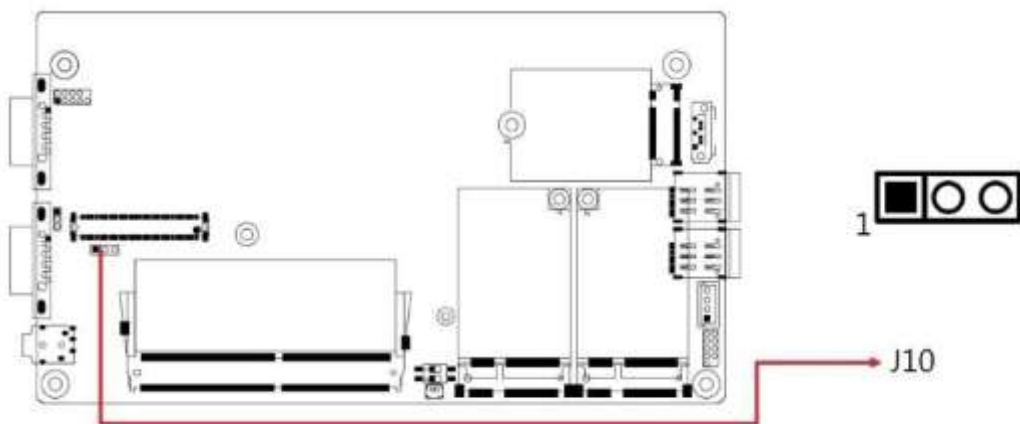

2.4.24 J11 : Board-to-Board Connector

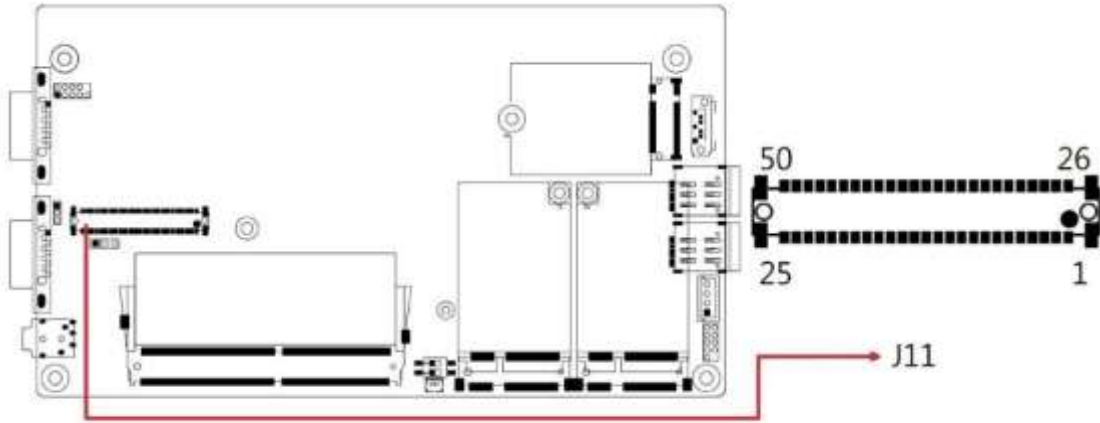

J11 : Board-to-Board Connector

Pin	Assignment	Pin	Assignment
1	Ground	26	VCC5
2	GPIO_IN0	27	VCC5
3	GPIO_IN1	28	GPIO_OUT0
4	GPIO_IN2	29	GPIO_OUT1
5	GPIO_IN3	30	GPIO_OUT2
6	(COM3) DSR, Data set ready	31	GPIO_OUT3
7	(COM3) RTS, Request to send	32	(COM3) DCD, Data carrier detect
8	(COM3) CTS, Clear to send	33	(COM3) RXD, Receive data
9	(COM3) RI, Ring indicator	34	(COM3) TXD, Transmit data
10	(COM4) DSR, Data set ready	35	(COM3) DTR, Data terminal ready
11	(COM4) RTS, Request to send	36	(COM4) DCD, Data carrier detect
12	(COM4) CTS, Clear to send	37	(COM4) RXD, Receive data
13	(COM4) RI, Ring indicator	38	(COM4) TXD, Transmit data
14	Ground	39	(COM4) DTR, Data terminal ready
15	USB_D+	40	Ground
16	USB_D-	41	PLT_RST#
17	Ground	42	Ground
18	USB_D+	43	PCIE_CLK_DP
19	USB_D-	44	PCIE_CLK_DN
20	Ground	45	Ground
21	VCC3_3	46	PCIE_RXP
22	VCC3_3	47	PCIE_RXN
23	Ground	48	Ground
24	3VDUAL	49	PCIE_TXP
25	3VDUAL	50	PCIE_TXN

2.4.25 J13 : M.2 B-Key Socket (Supports SATA / PCIe /USB)

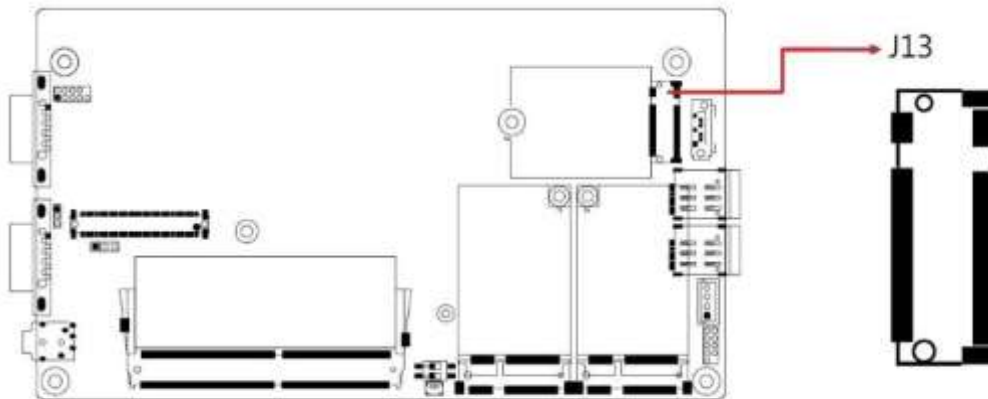

2.4.26 J14 : Port 80 Header

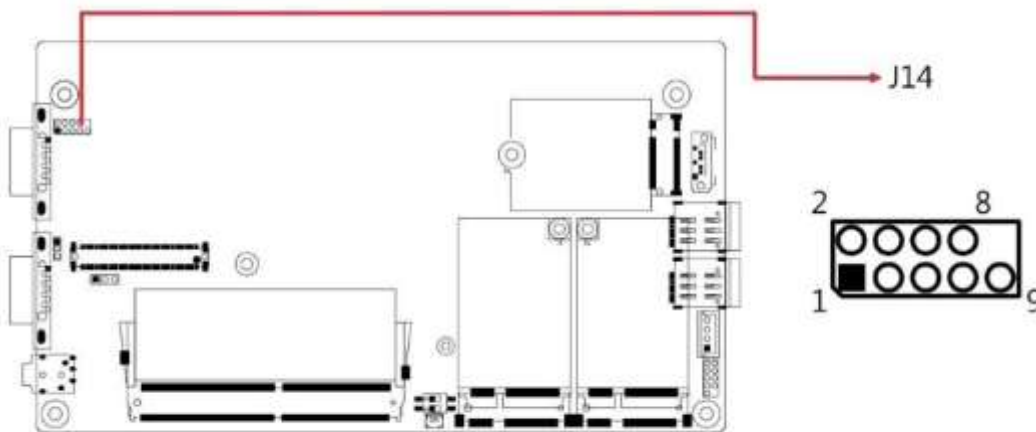

2.4.27 LED1: Power_Fail (Red)

2.4.28 LED2: Heartbeat (Blue)

2.4.29 LED3: WWAN1 (Green)

2.4.30 LED4: WWAN2 (Green)

Chapter 3

Driver Installation

The information provided in this chapter includes:

- Intel® Chipset Software Installation Utility
- Graphics Driver Installation
- HD Audio Driver Installation
- Intel® Management Engine Drivers Installation
- LAN Driver Installation

3.1 Introduction

This section describes the installation procedures for software drivers. The software drivers are in a disk enclosed with the product package. If you find anything missing, please contact the distributor where you made the purchase.

Note: After installing your Windows operating system, you must install the Intel® Chipset Software Installation Utility first before proceeding with the drivers installation.

3.2 Intel® Chipset Software Installation Utility

The Intel® Chipset drivers should be installed first before the software drivers to install INF files for Plug & Play function for the chipset components. Follow the instructions below to complete the installation.

1. Insert the disk enclosed in the package with the board. Click **Intel** on the left pane and then **Intel(R) Elkhartlake Chipset Drivers** on the right pane.

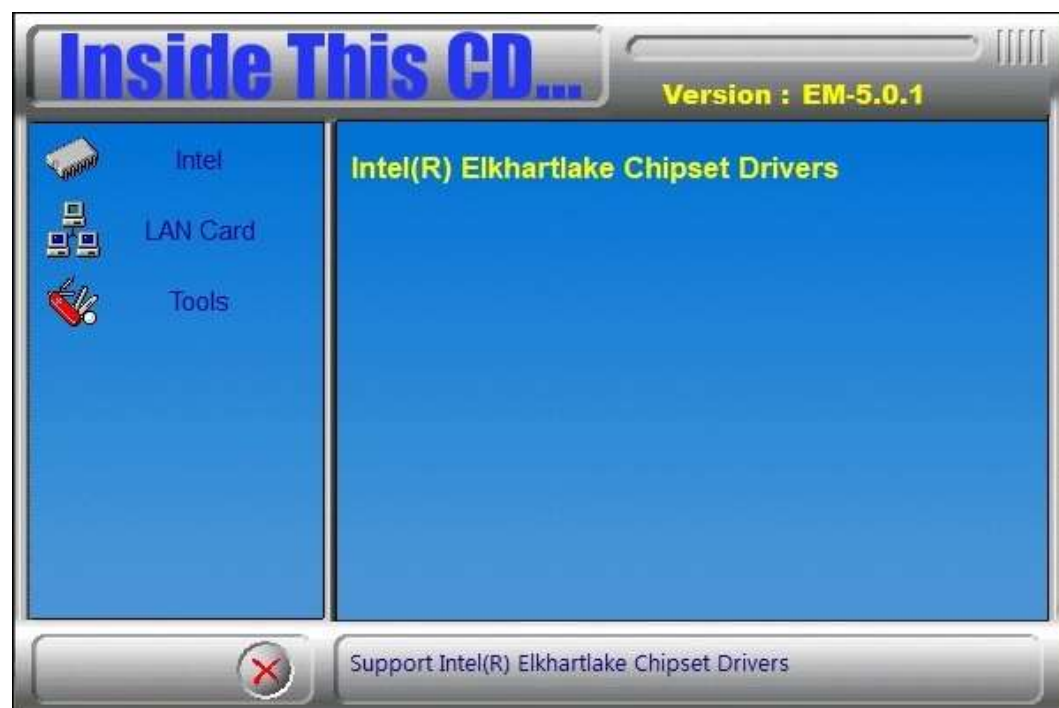

2. Click **Intel(R) Chipset Software Installation Utility**.



3. When the *Welcome* screen to the Intel® Chipset Device Software appears, click **Next** to continue.
4. Accept the software license agreement and proceed with the installation process.
5. On the *Readme File Information* screen, click **Install** for installation.
6. After the installation, press **Finish** to complete the setup process.

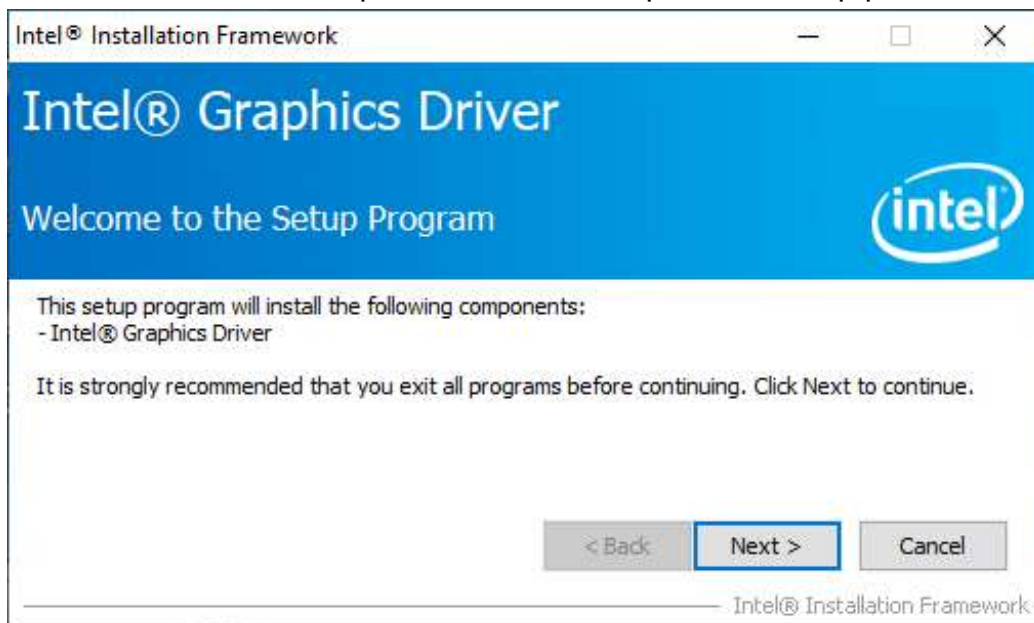

3.3 Graphics Driver Installation

1. Insert the disk enclosed in the package with the board. Click **Intel** on the left pane and then **Intel(R) Elkhartlake Chipset Drivers** on the right pane.
2. Click **Intel(R) Elkhartlake Graphics Driver**.



3. When the *Welcome* screen appears, click **Next** to continue.

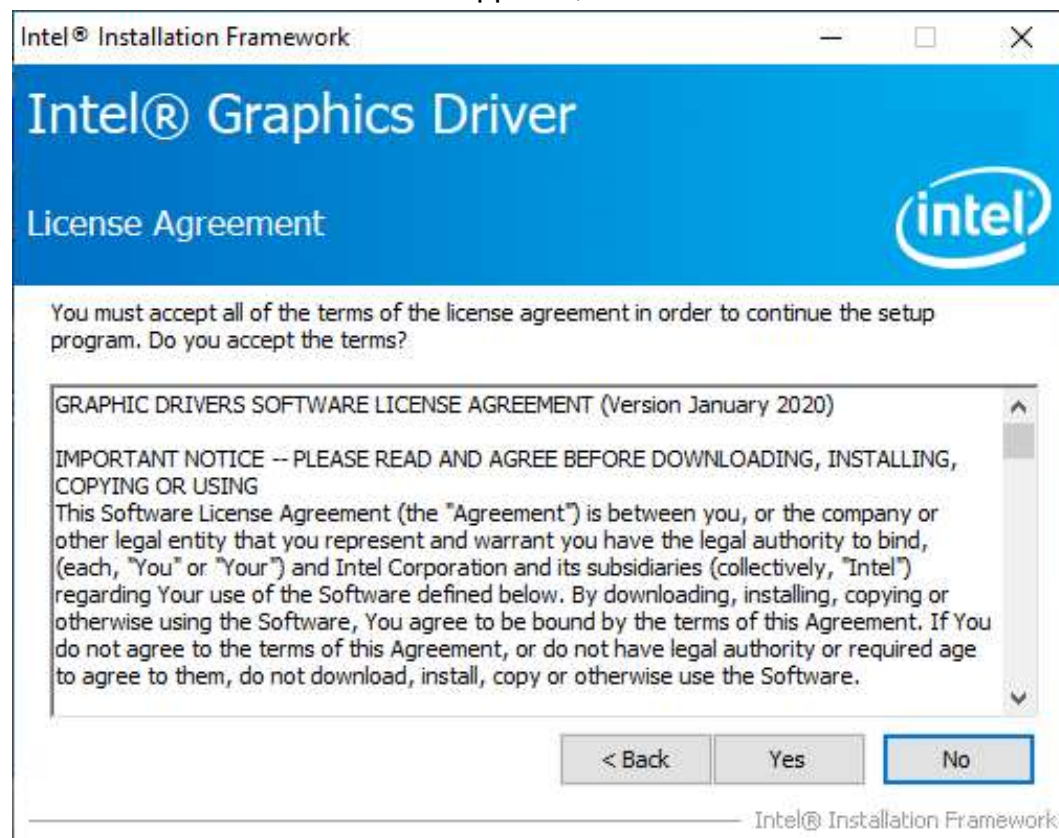

- Click **Yes** to accept the license agreement and click **Next** in The Readme File Information screen. Click **Next** in the Setup Progress screen.

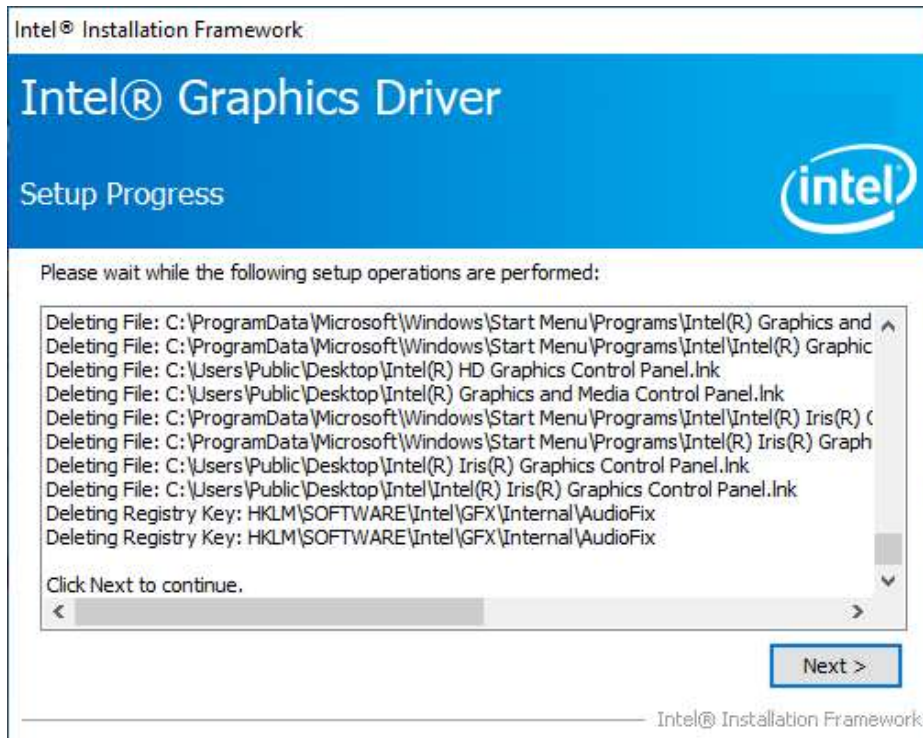

- Restart the computer when prompted. Click **Finish**, then remove any installation media from the drives.

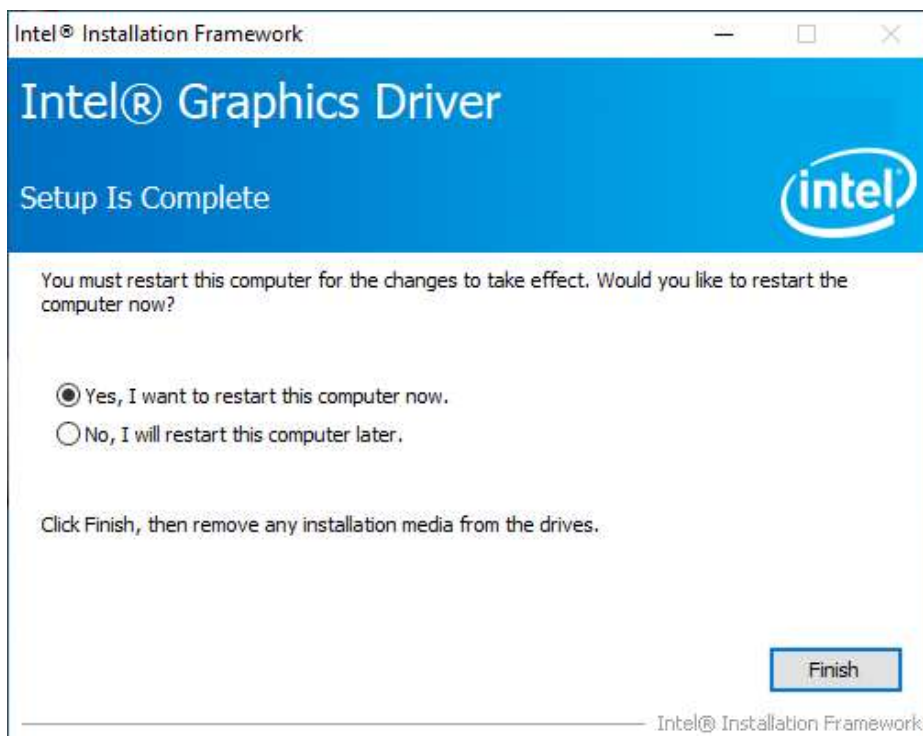

3.4 HD Audio Driver Installation

1. Insert the disk enclosed in the package with the board. Click Intel on the left pane and then **Intel(R) Elkhartlake Chipset Drivers** on the right pane.
2. Click **Realtek High Definition Audio Driver**.



3. On the Welcome screen, click **Next** to continue.

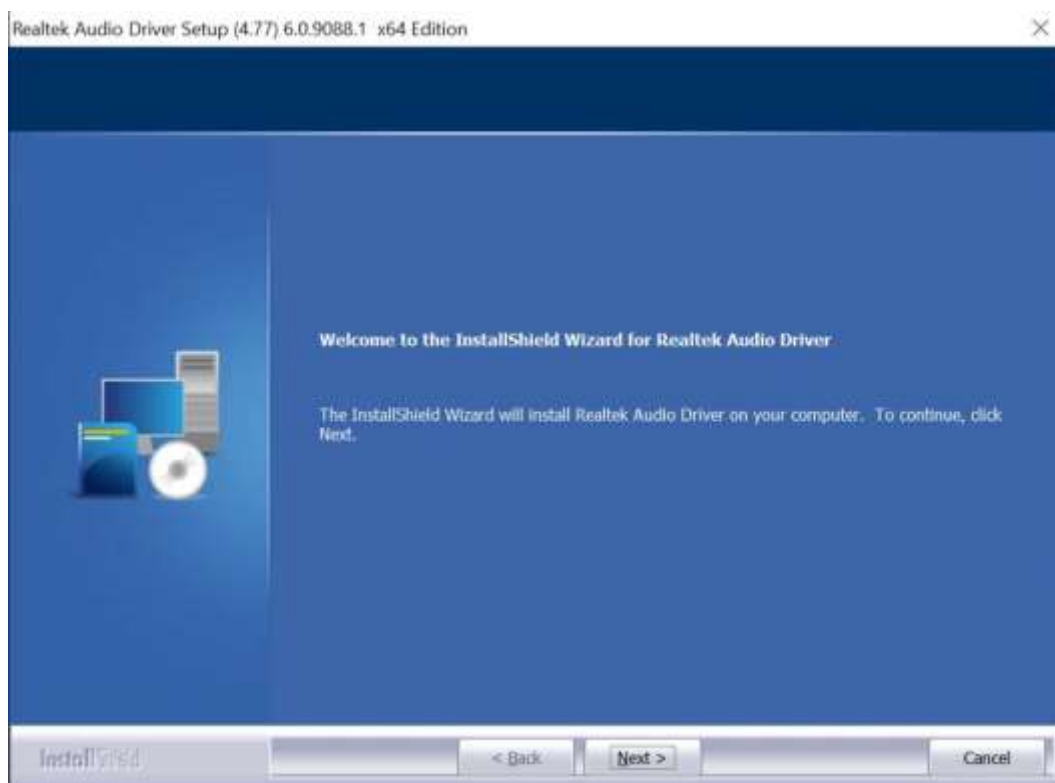

4. When the InstallShield Wizard has successfully installed the Realtek Audio Driver, restart the computer. Click **Finish** to complete the setup.

3.5 Intel® ME Drivers Installation

1. Insert the disk enclosed in the package with the board. Click Intel on the left pane and then **Intel(R) ME Drivers**.



2. The welcome screen to the Intel® Management Engine Components appears. Click **Next** to continue.

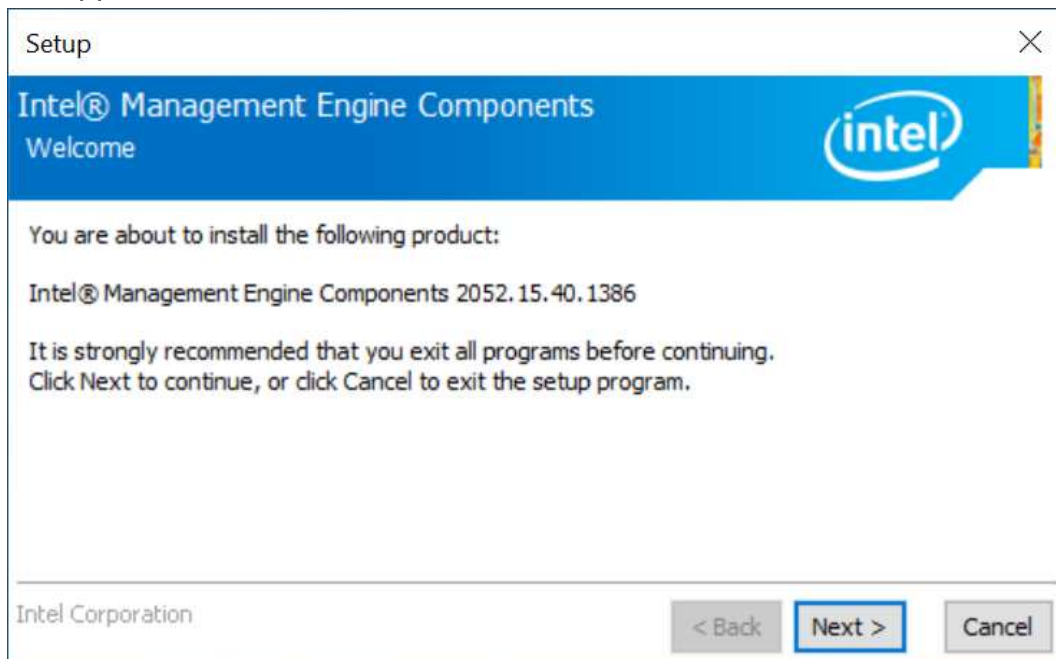

3. Accept the license agreement and click Next.

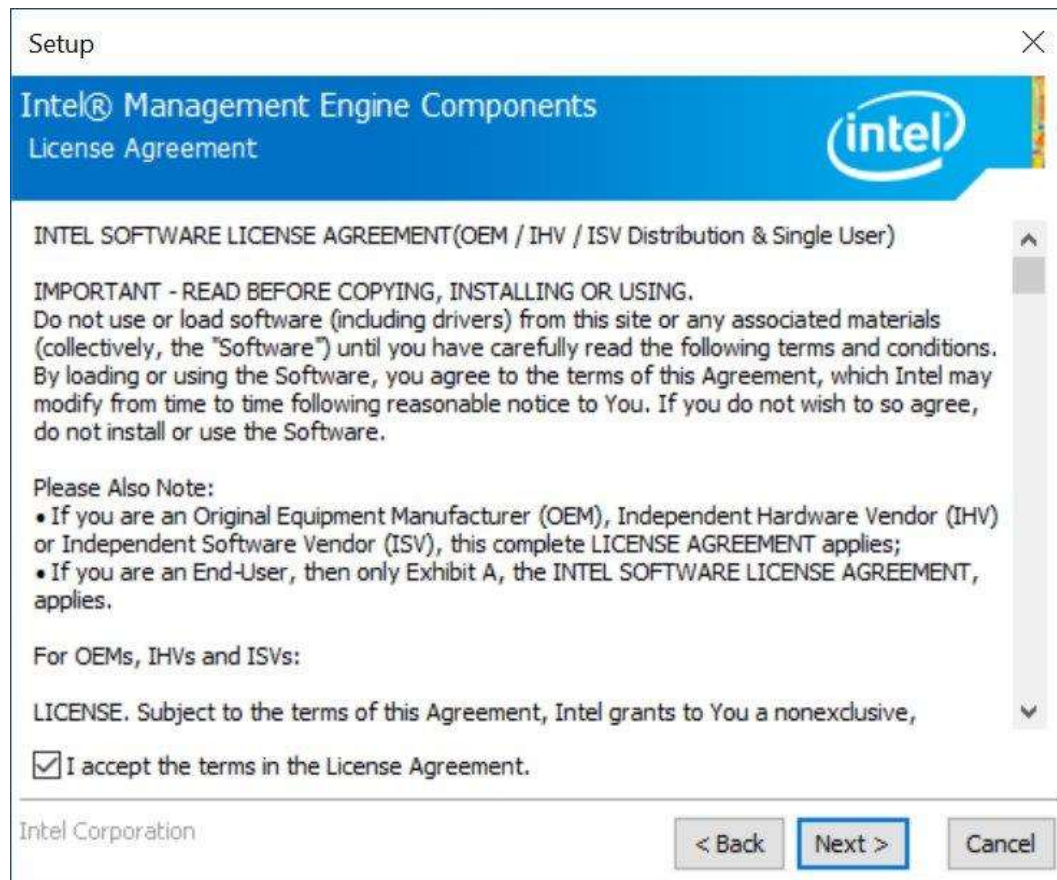

4. On the Setup's Destination Folder screen, click Next to continue.

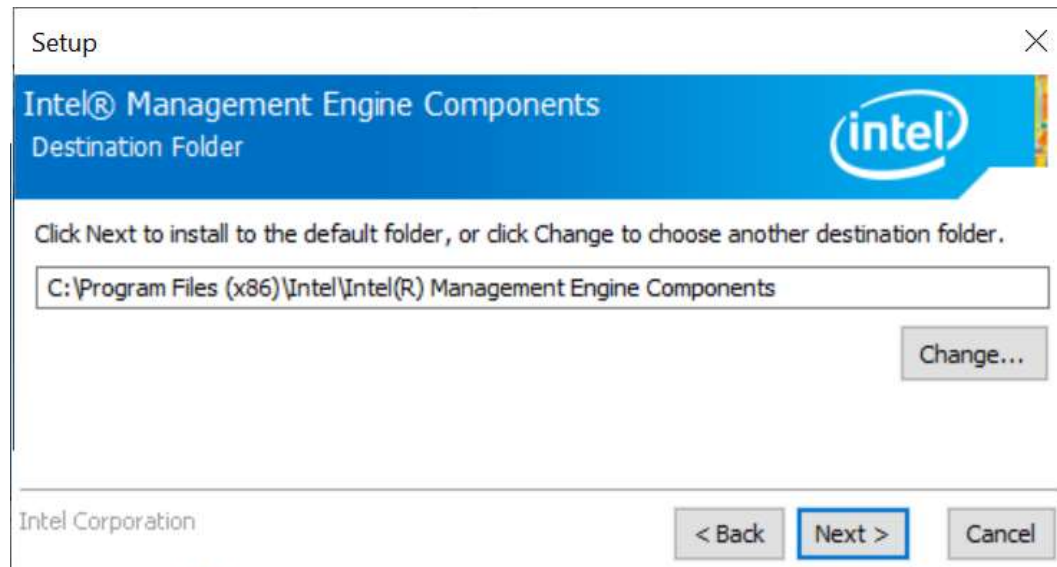

5. After the Intel components have been completely installed, click Finish.

3.6 LAN Driver Installation

1. Insert the disk enclosed in the package with the board. Click **LAN Card** on the left pane and then **Intel LAN Controller Drivers** on the right pane.



2. Choose **Intel(R) I21x Gigabit Network Drivers**.



3. In the welcome screen to the install wizard for Intel(R) Network Connections, click **Next**.
4. On the next screen, accept the terms in the license agreement and click **Next**.

5. In the *Setup Options* screen, click **Next**.

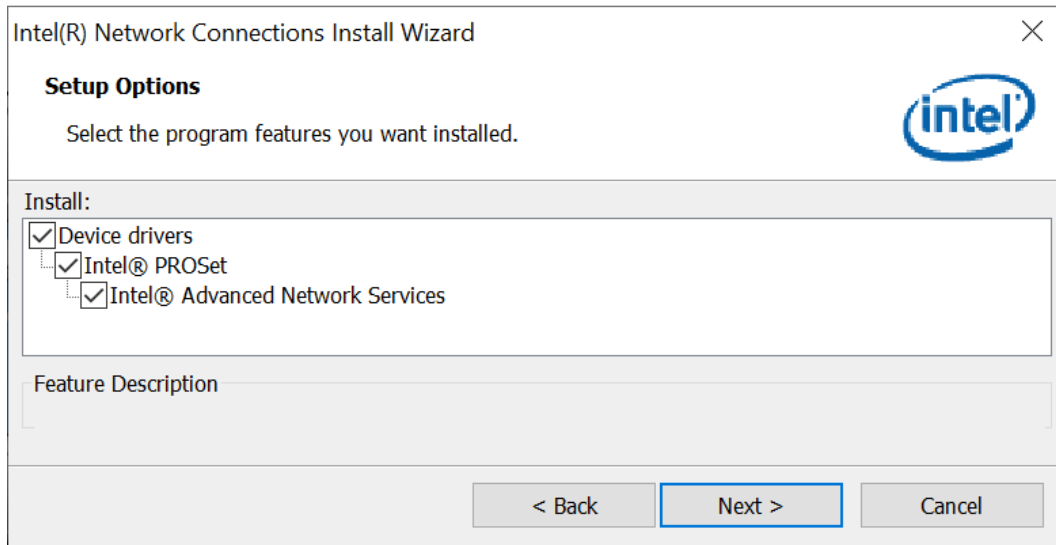

6. Click **install** to begin the installation.

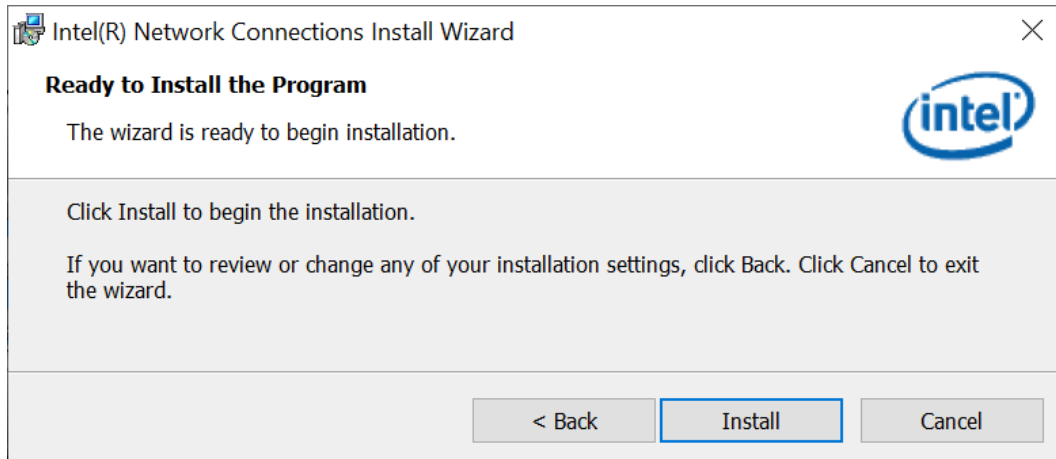

7. Click **Finish** when Install wizard has completed.

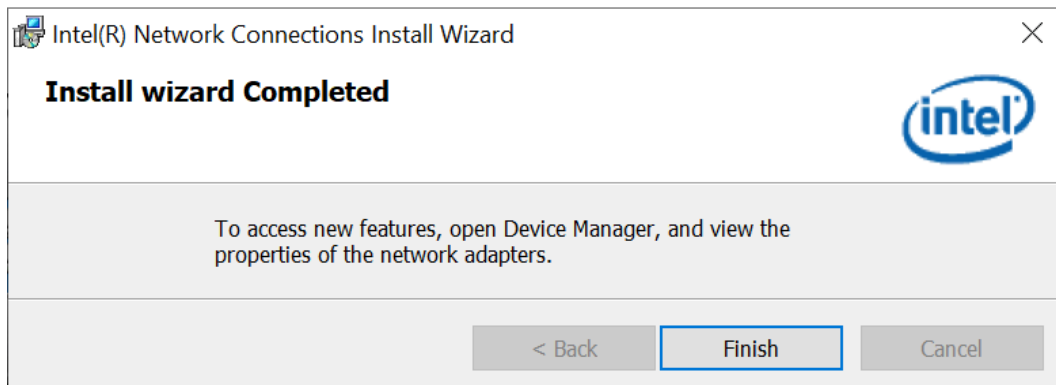

Chapter 4

BIOS Setup

This chapter describes the different settings available in the AMI BIOS that comes with the board. The topics covered in this chapter are as follows:

- Main Settings
- Advanced Settings
- Chipset Settings
- Security Settings
- Boot Settings
- Save & Exit

4.1 Introduction

The BIOS (Basic Input/Output System) installed in the ROM of your computer system supports Intel® processors. The BIOS provides critical low-level support for standard devices such as disk drives, serial ports and parallel ports. It also provides password protection as well as special support for detailed fine-tuning of the chipset controlling the entire system.

4.2 BIOS Setup

The BIOS provides a Setup utility program for specifying the system configurations and settings. The BIOS ROM of the system stores the Setup utility. When you turn on the computer, the BIOS is immediately activated. Press the key immediately allows you to enter the Setup utility. If you are a little bit late pressing the key, POST (Power On Self Test) will continue with its test routines, thus preventing you from invoking the Setup.

If you still need to enter Setup, restart the system by pressing the "Reset" button or simultaneously pressing the <Ctrl>, <Alt> and <Delete> keys. You can also restart by turning the system Off and back On again.

The following message will appear on the screen:

```
Press <DEL> to Enter Setup
```

In general, press the arrow keys to highlight items, <Enter> to select, the <PgUp> and <PgDn> keys to change entries, <F1> for help, and <Esc> to quit.

When you enter the BIOS Setup utility, the *Main Menu* screen will appear on the screen. The Main Menu allows you to select from various setup functions and exit choices.

Warning: It is strongly recommended that you avoid making any changes to the chipset defaults.

These defaults have been carefully chosen by both AMI and your system manufacturer to provide the absolute maximum performance and reliability. Changing the defaults could make the system unstable and crash in some cases.

4.3 Main Settings



BIOS Setting	Description
System Date	Sets the date. Use the <Tab> key to switch between the data elements.
System Time	Set the time. Use the <Tab> key to switch between the data elements.

4.4 Advanced Settings

This section allows you to configure, improve your system and allows you to set up some system features according to your preference.



BIOS Setting	Description
CPU Configuration	Displays CPU configuration parameters.
PCH-FW Configuration	Configure Management Engine Technology Parameters.
Trusted Computing	Configure security device parameters.
ACPI Settings	Displays system ACPI parameters.
Fintek Super IO Configuration	Displays super IO chip parameters.
Fintek Hardware Monitor	Shows super IO monitor hardware status.
USB Configuration	Displays USB configuration parameters.
Network Stack Configuration	Enables / Disables UEFI Network Stack.

4.4.1 CPU Configuration



BIOS Setting	Description
Intel (VMX) Virtualization Technolgy	When enabled, a VMM can utilize the additional hardware capabilities provided by Varderpool Technology.

4.4.2 PCH-FW Configuration



BIOS Setting	Description
ME State	When disabled, ME will be put into ME temporarily Disabled Mode.

4.4.3 Trusted Computing

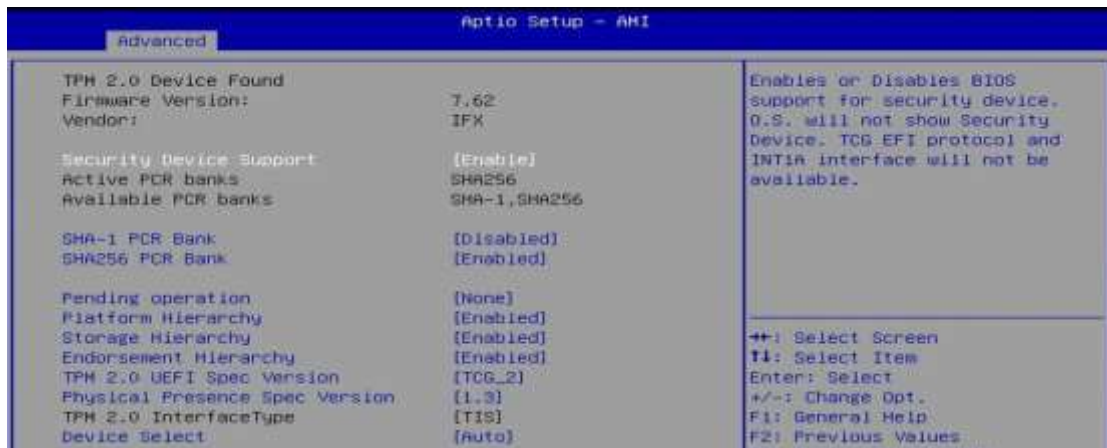

BIOS Setting	Description
Security Device Support	Enables / Disables BIOS support for security device. OS will not show security device. TCG EFI protocol and INTIA interface will not be available.
SHA-1 PCR Bank	Enables / Disables SHA-1 PCR Bank.
SHA256 PCR Bank	Enables / Disables SHA256 PCR Bank.
Pending operation	Schedule an operation for the security device. Note: Your computer will reboot during restart in order to change state of security device.
Platform Hierarchy	Enables / Disables platform hierarchy.
Storage Hierarchy	Enables / Disables storage hierarchy.
Endorsement Hierarchy	Enables / Disables endorsement hierarchy.
TPM2.0 UEFI Spec Version	Selects the supported TCG version based o your OS. <ul style="list-style-type: none"> • TCG_1_2: supports Windows 8 /10. • TCG_2: supports new TCG2 protocol and event format for Windows 10 or later.
Physical Presence Spec Version	Selects to show the PPI Spec Version (1.2 or 1.3) that the OS supports. Note: Some HCK tests might not support 1.3.
Device Select	<ul style="list-style-type: none"> • TPM 1.2 will restrict support to TPM 1.2 devices only. • TPM 2.0 will restrict support to TPM 2.0 devices only. • Auto will support both with the default being set to TPM 2.0 deices if not found, and TPM 1.2 device will be enumerated.

4.4.4 ACPI Settings



BIOS Setting	Description
Enable Hibernation	Enables / Disables the system ability to hibernate (OS/S4 Sleep State). This option may be not effective with some OS.
ACPI Sleep State	Selects an ACPI sleep state (Suspend Disabled or S3) where the system will enter when the Suspend button is pressed.

4.4.5 Fintek Super IO Configuration



BIOS Setting	Description
Power Failure	Options: Always on, Always off
Serial Ports Configuration	Sets parameters of serial ports. Enables / Disables the serial port and select an optimal setting for the Super IO device.

Serial Port 1 Configuration



Serial Port 2 Configuration



Serial Port 3 Configuration

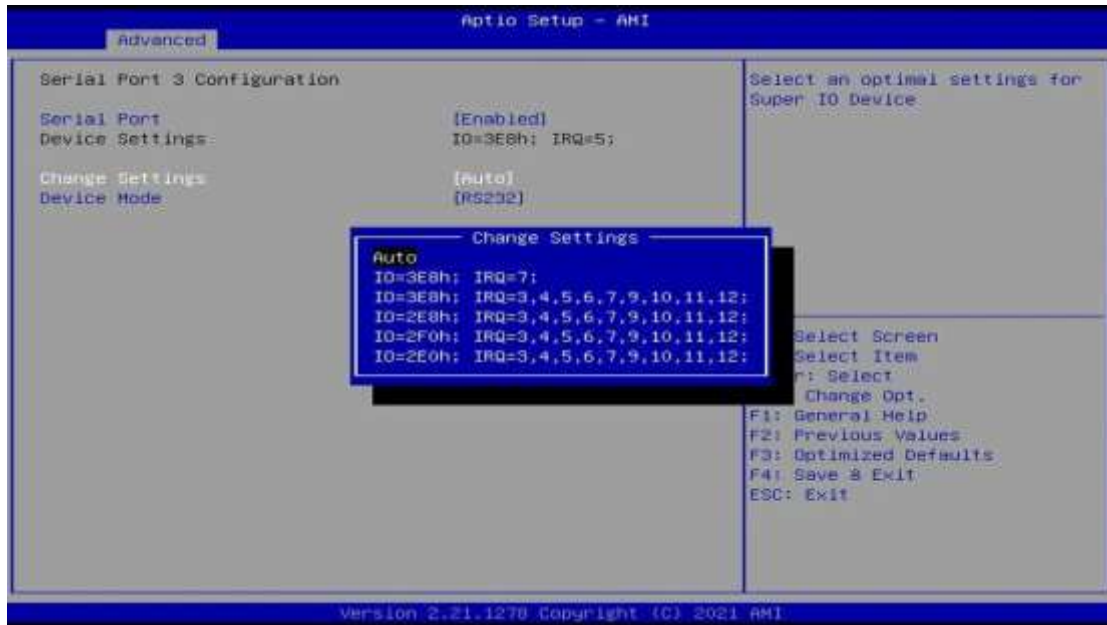

Serial Port 4 Configuration

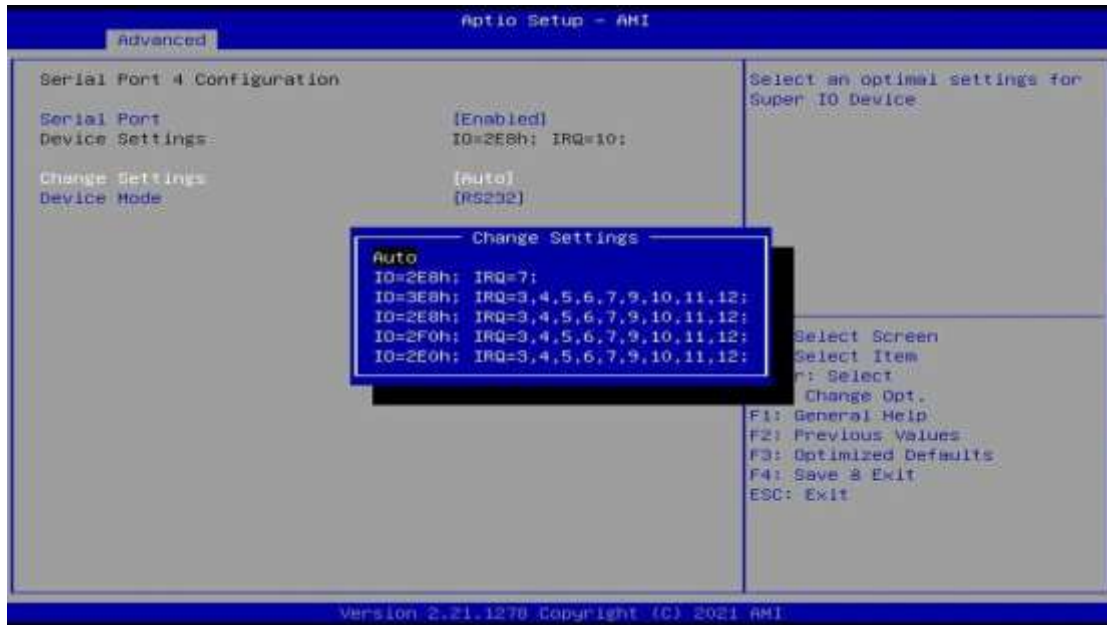

4.4.6 Fintek Hardware Monitor

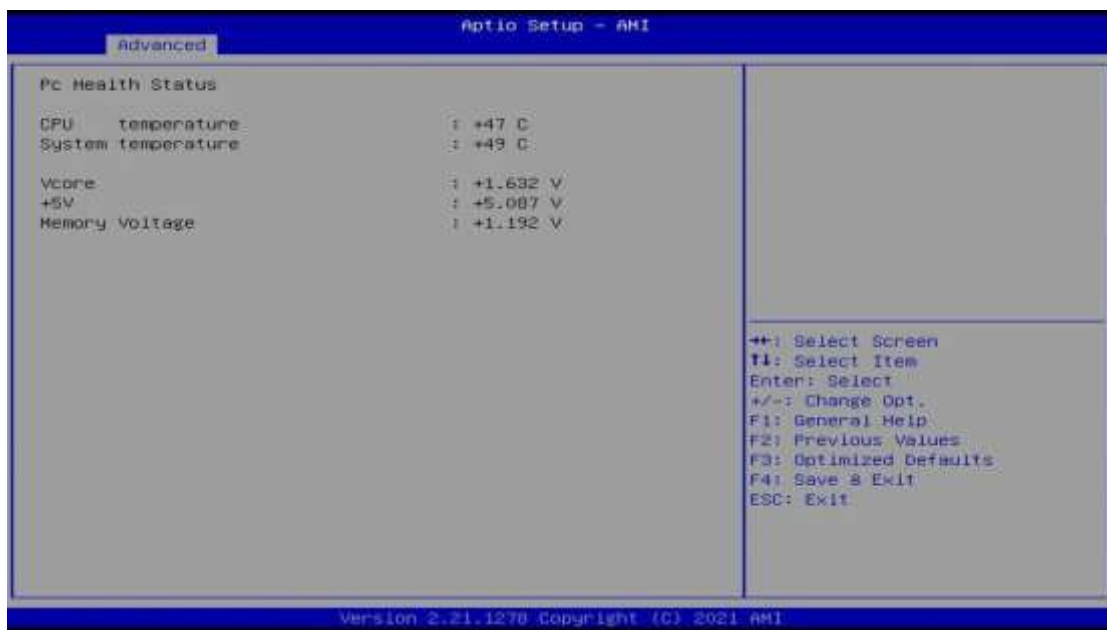

BIOS Setting	Description
Temperatures / Voltages	These fields are the parameters of the hardware monitoring function feature of the motherboard. The values are read-only as monitored by the system and showing the PC health status

4.4.7 USB Configuration



BIOS Setting	Description
Legacy USB Support	Enables / Disables Legacy USB support. <ul style="list-style-type: none"> • Auto disables legacy support if there is no USB device connected. • Disable keeps USB devices available only for EFI applications.
XHCI Hand-pff	This is a workaround for OSES without XHCI hand-off support. The XHCI ownership change should be claimed by XHCI driver.
USB Mass Storage Driver Support	Enables / Disables USB mass storage driver support.
USB Transfer time-out	Sets the time-out value 1, 5, 10 or 20 sec(s) for Control, Bulk, and Interrupt transfers.
Device reset time-out	Sets the seconds (10, 20, 30, 40 secs) of delaying execution of start unit command to USB mass storage device.
Device power-up delay	The maximum time the device will take before it properly reports itself to the Host Controller. Auto uses default value. For a Root port, it is 100 ms. For a Hub port, the delay is taken from Hub descriptor.
Generic Ultra MS-COMBO	Mas storage device emulation type. 'AUTO' enumerates devices according to their media format. Optical drives are emulated as 'CDROM' drives with no media will be emulated according to a drive type

4.4.8 Network Stack Configuration



BIOS Setting	Description
Network Stack	Enables / Disables UEFI Network Stack.

4.5 Chipset Settings

4.5.1 System Agent (SA) Configuration

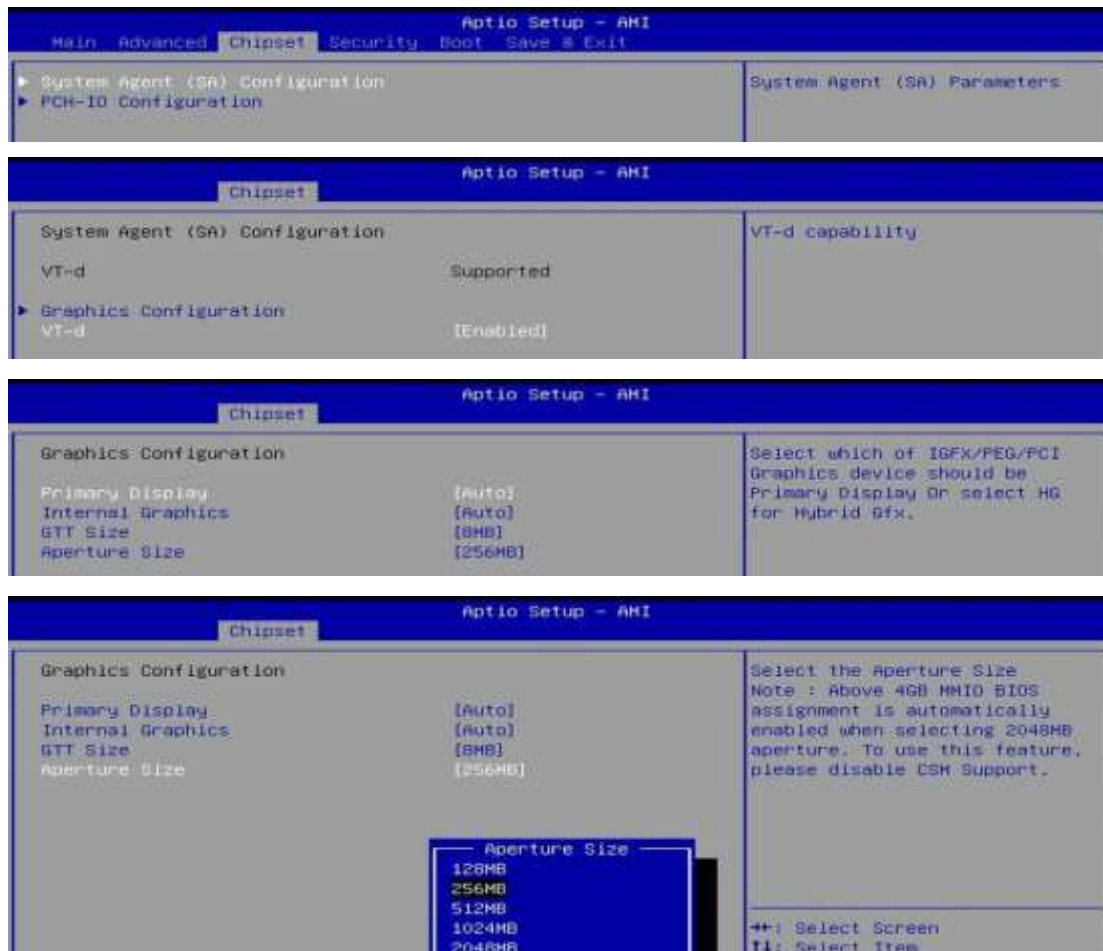

BIOS Setting	Description
Primary display	Select which of IGFX/PEG/PCI Graphics device should be Primary Display or select HG for Hybrid Gfx
Internal Graphics	Keep IGFX enabled based on the setup options
GTT Size	Options: 2MB, 4MB, 8MB
Aperture Size	Select the Aperture Size. Note: Above 4GB MMIO BIOS assignment is automatically enabled when selecting 2048MB aperture. To use this feature, please disable CSM Support

4.5.2 PCH-IO Configuration

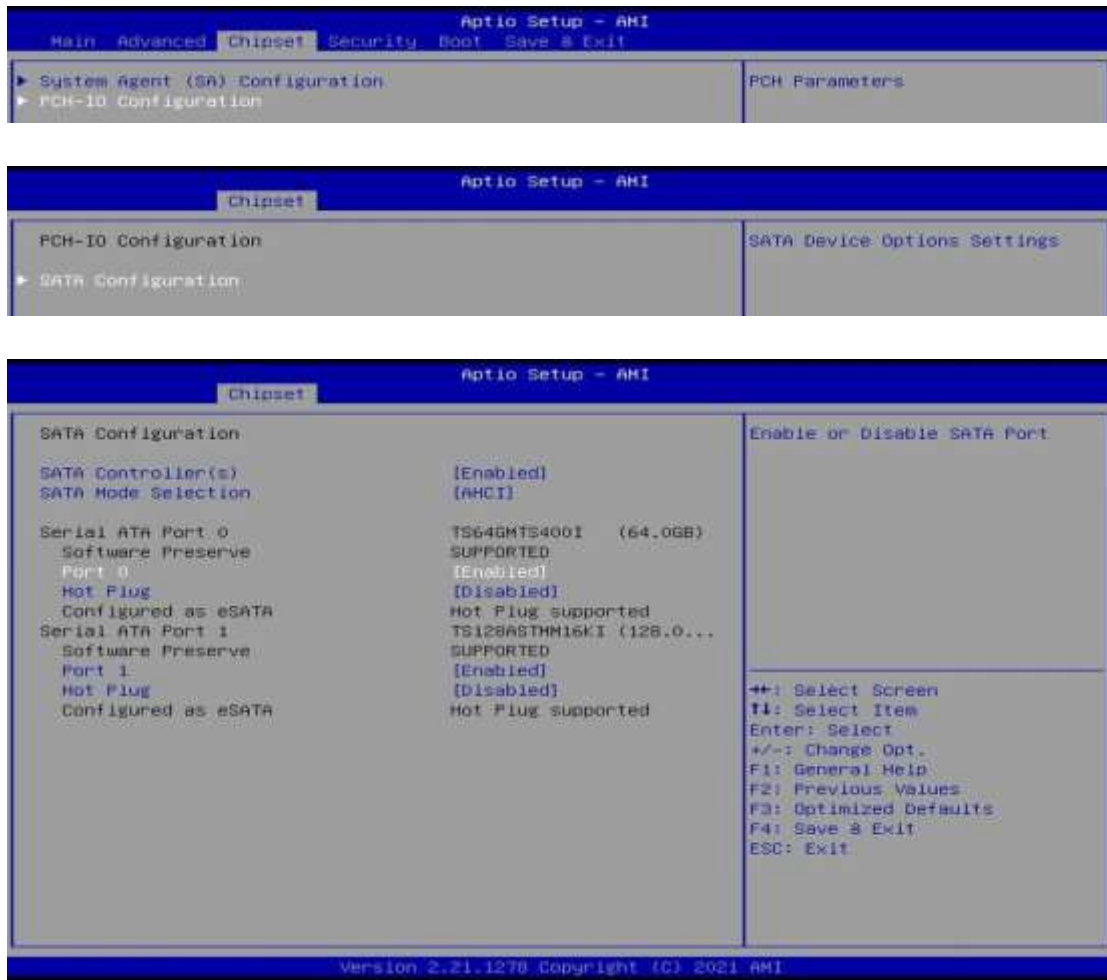

BIOS Setting	Description
SATA Controller(s)	Enables / Disables the Serial ATA.
SATA Mode Selection	Determines how SATA controller(s) operate.
Serial ATA Port 0~1	Enables / Disables Serial Port 0~1.
SATA Ports Hot Plug	Enables / Disables SATA Ports HotPlug.

4.6 Security Settings



BIOS Setting	Description
Setup Administrator Password	Sets an administrator password for the setup utility.
User Password	Sets a user password.
Secure Boot	Secure Boot Configuration



Aptio Setup - AMI

Chipset

SATA Configuration		Determines how SATA controller(s) operate.
SATA Controller(s)	[Enabled]	
SATA Mode Selection	[AHCI]	
Serial ATA Port 0	TS64GMS400I (64.0GB)	
Software Preserve	SUPPORTED	
Port 0	[Enabled]	
Hot Plug	[Disabled]	
Configured as eSATA	Hot Plug supported	
Serial ATA Port 1	TS128ASTHM16KI (128.0...	
Software Preserve	SUPPORTED	
Port 1	[Enabled]	
Hot Plug	[Disabled]	
Configured as eSATA	Hot Plug supported	

++: Select Screen
 ↑↓: Select Item
 Enter: Select
 +/-: Change Opt.
 F1: General Help
 F2: Previous Values
 F3: Optimized Defaults
 F4: Save & Exit
 ESC: Exit

Version 2.21.1278 Copyright (C) 2021 AMI

Aptio Setup - AMI

Chipset

SATA Configuration		Enable or Disable SATA Port
SATA Controller(s)	[Enabled]	
SATA Mode Selection	[AHCI]	
Serial ATA Port 0	TS64GMS400I (64.0GB)	
Software Preserve	SUPPORTED	
Port 0	[Enabled]	
Hot Plug	[Disabled]	
Configured as eSATA	Hot Plug supported	
Serial ATA Port 1	TS128ASTHM16KI (128.0...	
Software Preserve	SUPPORTED	
Port 1	[Enabled]	
Hot Plug	[Disabled]	
Configured as eSATA	Hot Plug supported	

++: Select Screen
 ↑↓: Select Item
 Enter: Select

Aptio Setup - AMI

Chipset

SATA Configuration		Designates this port as Hot Pluggable.
SATA Controller(s)	[Enabled]	
SATA Mode Selection	[AHCI]	
Serial ATA Port 0	TS64GMS400I (64.0GB)	
Software Preserve	SUPPORTED	
Port 0	[Enabled]	
Hot Plug	[Disabled]	
Configured as eSATA	Hot Plug supported	
Serial ATA Port 1	TS128ASTHM16KI (128.0...	
Software Preserve	SUPPORTED	
Port 1	[Enabled]	
Hot Plug	[Disabled]	
Configured as eSATA	Hot Plug supported	

++: Select Screen
 ↑↓: Select Item
 Enter: Select
 +/-: Change Opt.
 F1: General Help
 F2: Previous Values
 F3: Optimized Defaults
 F4: Save & Exit
 ESC: Exit

Version 2.21.1278 Copyright (C) 2021 AMI



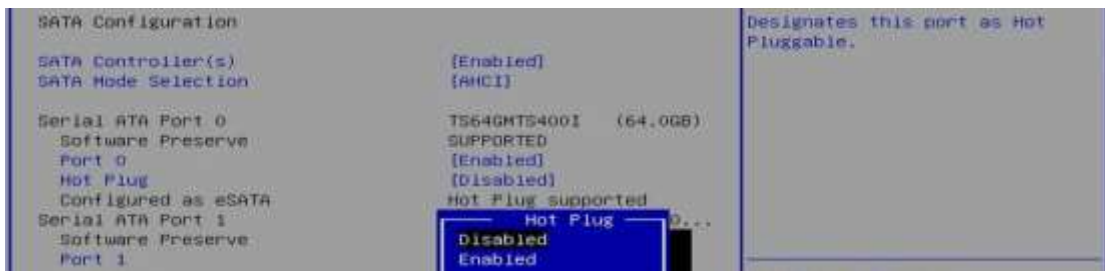
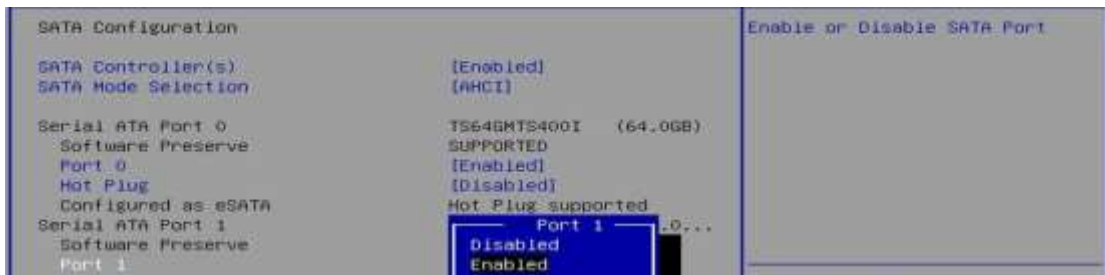
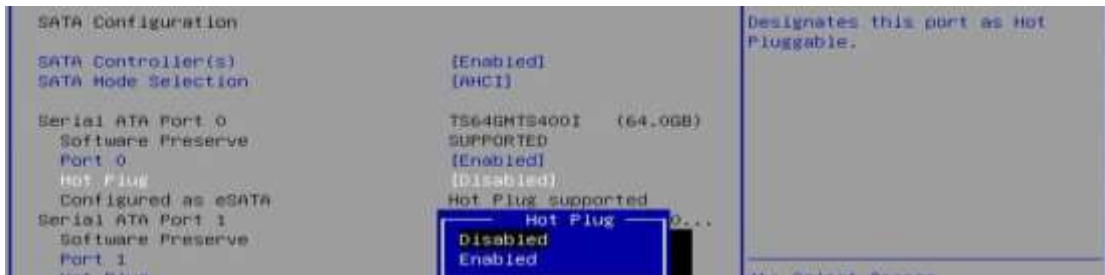

4.7 Boot Settings



BIOS Setting	Description
Setup Prompt Timeout	Number of seconds to wait for setup activation key. 65535 (0xFFFF) means indefinite waiting.
Bootup NumLock State	Turns on/off the keyboard NumLock state.
Quiet Boot	Enables / Disables Quiet Boot option.
Fixed Boot Order Priorities	Sets the system boot order.
UEFI Hard Disk Drive BBS Priorities	Specifies the boot device priority sequence from available UEFI hard disk drives.

4.8 Save & Exit Settings



BIOS Setting	Description
Save Changes and Exit	Exits system setup after saving the changes.
Discard Changes and Exit	Exits system setup without saving any changes.
Save Changes and Reset	Resets the system after saving the changes.
Discard Changes and Reset	Resets system setup without saving any changes.
Save Changes	Saves changes done so far to any of the setup options.
Discard Changes	Discards changes done so far to any of the setup options.
Restore Defaults	Restores / Loads defaults values for all the setup options.
Save as User Defaults	Saves the changes done so far as user defaults.
Restore User Defaults	Restores the user defaults to all the setup options.

Appendix

This section provides the mapping addresses of peripheral devices and the sample code of watchdog timer configuration.

- I/O Port Address Map
- Interrupt Request Lines (IRQ)
- Watchdog Timer Configuration

A. I/O Port Address Map

Resource	Device
0x00000000-0x000000CF7	PCI Express Root Complex
0x00000020-0x00000021	Programmable interrupt controller
0x00000024-0x00000025	Programmable interrupt controller
0x00000028-0x00000029	Programmable interrupt controller
0x0000002C-0x0000002D	Programmable interrupt controller
0x0000002E-0x0000002F	Motherboard resources
0x00000030-0x00000031	Programmable interrupt controller
0x00000034-0x00000035	Programmable interrupt controller
0x00000038-0x00000039	Programmable interrupt controller
0x0000003C-0x0000003D	Programmable interrupt controller
0x00000040-0x00000043	System timer
0x0000004E-0x0000004F	Motherboard resources
0x00000050-0x00000053	System timer
0x00000061-0x00000061	Motherboard resources
0x00000063-0x00000063	Motherboard resources
0x00000065-0x00000065	Motherboard resources
0x00000067-0x00000067	Motherboard resources
0x00000070-0x00000070	Motherboard resources
0x00000080-0x00000080	Motherboard resources
0x00000092-0x00000092	Motherboard resources
0x000000A0-0x000000A1	Programmable interrupt controller
0x000000A4-0x000000A5	Programmable interrupt controller
0x000000A8-0x000000A9	Programmable interrupt controller
0x000000AC-0x000000AD	Programmable interrupt controller
0x000000B0-0x000000B1	Programmable interrupt controller
0x000000B2-0x000000B3	Motherboard resources
0x000000B4-0x000000B5	Programmable interrupt controller
0x000000B8-0x000000B9	Programmable interrupt controller
0x000000BC-0x000000BD	Programmable interrupt controller
0x000002E8-0x000002EF	Communications Port (COM4)
0x000002F8-0x000002FF	Communications Port (COM2)
0x000003E8-0x000003EF	Communications Port (COM3)
0x000003F8-0x000003FF	Communications Port (COM1)
0x000004D0-0x000004D1	Programmable interrupt controller
0x00000680-0x0000069F	Motherboard resources
0x00000A00-0x00000A0F	Motherboard resources
0x00000A10-0x00000A1F	Motherboard resources

Resource	Device
0x00000063-0x00000063	Motherboard resources
0x00000065-0x00000065	Motherboard resources
0x00000067-0x00000067	Motherboard resources
0x00000070-0x00000070	Motherboard resources
0x00000080-0x00000080	Motherboard resources
0x00000092-0x00000092	Motherboard resources
0x000000A0-0x000000A1	Programmable interrupt controller
0x000000A4-0x000000A5	Programmable interrupt controller
0x000000A8-0x000000A9	Programmable interrupt controller
0x000000AC-0x000000AD	Programmable interrupt controller
0x000000B0-0x000000B1	Programmable interrupt controller
0x000000B2-0x000000B3	Motherboard resources
0x000000B4-0x000000B5	Programmable interrupt controller
0x000000B8-0x000000B9	Programmable interrupt controller
0x000000BC-0x000000BD	Programmable interrupt controller
0x000002E8-0x000002EF	Communications Port (COM4)
0x000002F8-0x000002FF	Communications Port (COM2)
0x000003E8-0x000003EF	Communications Port (COM3)
0x000003F8-0x000003FF	Communications Port (COM1)
0x000004D0-0x000004D1	Programmable interrupt controller
0x00000680-0x0000069F	Motherboard resources
0x00000A00-0x00000A0F	Motherboard resources
0x00000A10-0x00000A1F	Motherboard resources
0x00000A20-0x00000A2F	Motherboard resources
0x00000D00-0x0000FFFF	PCI Express Root Complex
0x0000164E-0x0000164F	Motherboard resources
0x00001800-0x000018FE	Motherboard resources
0x00001854-0x00001857	Motherboard resources
0x00002000-0x000020FE	Motherboard resources
0x00003000-0x00003FFF	Intel(R) PCI Express Root Port #2 - 4B3A
0x00004000-0x00004FFF	Intel(R) PCI Express Root Port #1 - 4B39
0x00005000-0x00005FFF	Intel(R) PCI Express Root Port #0 - 4B38
0x00006000-0x0000603F	Intel(R) UHD Graphics
0x00006060-0x0000607F	Standard SATA AHCI Controller
0x00006080-0x00006083	Standard SATA AHCI Controller
0x00006090-0x00006097	Standard SATA AHCI Controller
0x0000EFA0-0x0000EFBF	Intel(R) SMBus Controller - 4B23

B. Interrupt Request Lines (IRQ)

Peripheral devices use interrupt request lines to notify CPU for the service required. The following table shows the IRQ used by the devices on board.

Level	Function
IRQ 0	System timer
IRQ 3	Communications Port (COM2)
IRQ 4	Communications Port (COM1)
IRQ 5	Communications Port (COM3)
IRQ 10	Communications Port (COM4)
IRQ 16	High Definition Audio Controller
IRQ 55 ~ IRQ 204	Microsoft ACPI-Compliant System
IRQ 256 ~ IRQ 511	Microsoft ACPI-Compliant System
IRQ 4294967273	Intel(R) Management Engine Interface
IRQ 4294967274~79	Intel I210 Gigabit Network Connection #5
IRQ 4294967280~85	Intel I210 Gigabit Network Connection #6
IRQ 4294967286~91	Intel I210 Gigabit Network Connection #4
IRQ 4294967292	Intel(R) UHD Graphics
IRQ 4294967293	Intel(R) USB 3.10 eXtensible Host Controller - 1.20 (Microsoft)
IRQ 4294967294	Standard SATA AHCI Controller

C. Watchdog Timer Configuration

The Watchdog Timer (WDT) is used to generate a variety of output signals after a user programmable count. The WDT is suitable for the use in the prevention of system lock-up, such as when software becomes trapped in a deadlock. Under these sorts of circumstances, the timer will count to zero and the selected outputs will be driven.

Under normal circumstance, you will need to restart the WDT at regular intervals before the timer counts to zero.

Sample Code

```
//-----
//
// THIS CODE AND INFORMATION IS PROVIDED "AS IS" WITHOUT WARRANTY OF ANY
// KIND, EITHER EXPRESSED OR IMPLIED, INCLUDING BUT NOT LIMITED TO THE
// IMPLIED WARRANTIES OF MERCHANTABILITY AND/OR FITNESS FOR A PARTICULAR
// PURPOSE.
//
//-----
#include <dos.h>
#include <conio.h>
#include <stdio.h>
#include <stdlib.h>
#include "F81964.H"
//-----
int main (int argc, char *argv[]); void EnableWDT(int);
void DisableWDT(void);
//-----
int main (int argc, char *argv[])
{
    unsigned char bBuf;
    unsigned char bTime;
    char **endptr;

    char SIO;
    printf("Fintek 81866 watch dog program\n");
    SIO = Init_F81964();
    if (SIO == 0)
    {
        printf("Can not detect Fintek 81866, program abort.\n");
        return(1);
    }/if (SIO == 0)

    if (argc != 2)
    {
        printf(" Parameter incorrect!!\n");
        return (1);
    }

    bTime = strtol (argv[1], endptr, 10);
```

```

printf("System will reset after %d seconds\n", bTime);

if (bTime)
{   EnableWDT(bTime); }
else
{   DisableWDT(); }
return 0;
}
//-----
void EnableWDT(int interval)
{
    unsigned char bBuf;

    bBuf = Get_F81964_Reg(0x2B);
    bBuf &= (~0x20);
    Set_F81964_Reg(0x2B, bBuf);           //Enable WDTO

    Set_F81964_LD(0x07);                 //switch to logic device 7
    Set_F81964_Reg(0x30, 0x01);         //enable timer

    bBuf = Get_F81964_Reg(0xF5);
    bBuf &= (~0x0F);
    bBuf |= 0x52;
    Set_F81964_Reg(0xF5, bBuf);         //count mode is second
    Set_F81964_Reg(0xF6, interval);     //set timer
    bBuf = Get_F81964_Reg(0xFA);
    bBuf |= 0x01;
    Set_F81964_Reg(0xFA, bBuf);         //enable WDTO output

    bBuf = Get_F81964_Reg(0xF5);
    bBuf |= 0x20;
    Set_F81964_Reg(0xF5, bBuf);         //start counting
}
//-----
void DisableWDT(void)
{
    unsigned char bBuf;
    Set_F81964_LD(0x07);                 //switch to logic device 7
    bBuf = Get_F81964_Reg(0xFA);
    bBuf &= ~0x01;
    Set_F81964_Reg(0xFA, bBuf);         //disable WDTO output

    bBuf = Get_F81964_Reg(0xF5);
    bBuf &= ~0x20;
    bBuf |= 0x40;
    Set_F81964_Reg(0xF5, bBuf);         //disable WDT
}
//-----

```

```

//-----
//
// THIS CODE AND INFORMATION IS PROVIDED "AS IS" WITHOUT WARRANTY OF ANY
// KIND, EITHER EXPRESSED OR IMPLIED, INCLUDING BUT NOT LIMITED TO THE
// IMPLIED WARRANTIES OF MERCHANTABILITY AND/OR FITNESS FOR A PARTICULAR
// PURPOSE.
//
//-----
#include "F81964.H"
#include <dos.h>
//-----
unsigned int F81964_BASE; void Unlock_F81964 (void); void Lock_F81964 (void);
//-----
unsigned int Init_F81964(void)
{
    unsigned int result;
    unsigned char ucDid;

    F81964_BASE = 0x4E;
    result = F81964_BASE;

    ucDid = Get_F81964_Reg(0x20);
    if (ucDid == 0x07)                                //Fintek 81866
    {    goto Init_Finish; }

    F81964_BASE = 0x2E;
    result = F81964_BASE;

    ucDid = Get_F81964_Reg(0x20);
    if (ucDid == 0x07)                                //Fintek 81866
    {    goto Init_Finish; }

    F81964_BASE = 0x00;
    result = F81964_BASE;

Init_Finish:
    return (result);
}
//-----
void Unlock_F81964 (void)
{
    outportb(F81964_INDEX_PORT, F81964_UNLOCK);
    outportb(F81964_INDEX_PORT, F81964_UNLOCK);
}
//-----
void Lock_F81964 (void)
{
    outportb(F81964_INDEX_PORT, F81964_LOCK);
}
//-----
void Set_F81964_LD( unsigned char LD)
{
    Unlock_F81964();
    outportb(F81964_INDEX_PORT, F81964_REG_LD);
}

```

```
    outportb(F81964_DATA_PORT, LD); Lock_F81964();
}
//-----
void Set_F81964_Reg( unsigned char REG, unsigned char DATA)
{
    Unlock_F81964();
    outportb(F81964_INDEX_PORT, REG);
    outportb(F81964_DATA_PORT, DATA);
    Lock_F81964();
}
//-----
unsigned char Get_F81964_Reg(unsigned char REG)
{
    unsigned char Result;
    Unlock_F81964();
    outportb(F81964_INDEX_PORT, REG);
    Result = inportb(F81964_DATA_PORT);
    Lock_F81964();
    return Result;
}
//-----

//-----
//
// THIS CODE AND INFORMATION IS PROVIDED "AS IS" WITHOUT WARRANTY OF ANY
// KIND, EITHER EXPRESSED OR IMPLIED, INCLUDING BUT NOT LIMITED TO THE
// IMPLIED WARRANTIES OF MERCHANTABILITY AND/OR FITNESS FOR A PARTICULAR
// PURPOSE.
//
//-----
#ifndef    F81964_H
#define    F81964_H    1
//-----
#define    F81964_INDEX_PORT    (F81964_BASE)
#define    F81964_DATA_PORT    (F81964_BASE+1)
//-----
#define    F81964_REG_LD    0x07
//-----
#define    F81964_UNLOCK    0x87
#define    F81964_LOCK    0xAA
//-----
unsigned int Init_F81964(void);
void Set_F81964_LD( unsigned char);
void Set_F81964_Reg( unsigned char, unsigned char); unsigned char
Get_F81964_Reg( unsigned char);
//-----
#endif //    F81964_H
```

Our company network supports you worldwide with offices in Germany, Austria, Switzerland, the UK and the USA. For more information please contact:

Headquarters

Germany



FORTEC Elektronik AG

Augsburger Str. 2b
82110 Germering

Phone: +49 89 894450-0
E-Mail: info@fortecaq.de
Internet: www.fortecaq.de

Fortec Group Members

Austria



Distec GmbH Office Vienna

Nuschingasse 12
1230 Wien

Phone: +43 1 8673492-0
E-Mail: info@distec.de
Internet: www.distec.de

Germany



Distec GmbH

Augsburger Str. 2b
82110 Germering

Phone: +49 89 894363-0
E-Mail: info@distec.de
Internet: www.distec.de

Switzerland



ALTRAC AG

Bahnhofstraße 3
5436 Würenlos

Phone: +41 44 7446111
E-Mail: info@altrac.ch
Internet: www.altrac.ch

United Kingdom



Display Technology Ltd.

Osprey House, 1 Osprey Court
Hinchingsbrooke Business Park
Huntingdon, Cambridgeshire, PE29 6FN

Phone: +44 1480 411600
E-Mail: info@displaytechnology.co.uk
Internet: www.displaytechnology.co.uk

USA



Apollo Display Technologies, Corp.

87 Raynor Avenue, Unit 1
Ronkonkoma, NY 11779

Phone: +1 631 5804360
E-Mail: info@apolloDisplays.com
Internet: www.apolloDisplays.com