



OUR GLOBAL
COMPETENCE
CENTRES

 APOLLO DISPLAY
TECHNOLOGIES



 DISTEC



 DISPLAY
TECHNOLOGY



Manual

iBASE

CSB200-818

Fanless Embedded Box PC with Intel® Apollo Lake Atom™ E3930, Pentium® N4200 and Celeron® N3350 Processor



The information contained in this document has been carefully researched and is, to the best of our knowledge, accurate. However, we assume no liability for any product failures or damages, immediate or consequential, resulting from the use of the information provided herein. Our products are not intended for use in systems in which failures of product could result in personal injury. All trademarks mentioned herein are property of their respective owners. All specifications are subject to change without notice.

CSB200-818

Slim & Fanless SBC System

User's Manual

Version 1.1
(May 2019)



Copyright

© 2019 IBASE Technology, Inc. All rights reserved.

No part of this publication may be reproduced, copied, stored in a retrieval system, translated into any language or transmitted in any form or by any means, electronic, mechanical, photocopying, or otherwise, without the prior written consent of IBASE Technology, Inc. (hereinafter referred to as "IBASE").

Disclaimer

IBASE reserves the right to make changes and improvements to the products described in this document without prior notice. Every effort has been made to ensure the information in the document is correct; however, IBASE does not guarantee this document is error-free. IBASE assumes no liability for incidental or consequential damages arising from misapplication or inability to use the product or the information contained herein, nor for any infringements of rights of third parties, which may result from its use.

Trademarks

All the trademarks, registrations and brands mentioned herein are used for identification purposes only and may be trademarks and/or registered trademarks of their respective owners.

Compliance

CE

This is a class B product. This product has passed CE tests for environmental specifications and limits. This product is in accordance with the directives of the Union European (EU). If users modify and/or install other devices in this equipment, the CE conformity declaration may no longer apply.

FCC

This product has been tested and found to comply with the limits for a Class B device, pursuant to Part 15 of the FCC Rules. These limits are designed to provide reasonable protection against harmful interference in a residential installation. This equipment generates, uses and can radiate radio frequency energy and, if not installed and used in accordance with manufacturer's instructions, may cause harmful interference to radio communications.

WEEE



This product must not be disposed of as normal household waste, in accordance with the EU directive of for waste electrical and electronic equipment (WEEE - 2012/19/EU). Instead, it should be disposed of by returning it to a municipal recycling collection point. Check local regulations for disposal of electronic products.

Green IBASE



This product is compliant with the current RoHS restrictions and prohibits use of the following substances in concentrations exceeding 0.1% by weight (1000 ppm) except for cadmium, limited to 0.01% by weight (100 ppm).

- Lead (Pb)
- Mercury (Hg)
- Cadmium (Cd)
- Hexavalent chromium (Cr6+)
- Polybrominated biphenyls (PBB)
- Polybrominated diphenyl ether (PBDE)

Important Safety Information

Carefully read the precautions before using the device.

Environmental conditions:

- Lay the device horizontally on a stable and solid surface in case the device may fall, causing serious damage.
- Leave plenty of space around the device and do not block the openings for ventilation. NEVER DROP OR INSERT ANY OBJECTS OF ANY KIND INTO THE VENTILATION OPENINGS.
- Slots and openings on the chassis are for ventilation. Do not block or cover these openings. Make sure you leave plenty of space around the device for ventilation. NEVER INSERT OBJECTS OF ANY KIND INTO THE VENTILATION OPENINGS.
- Use this product in environments with ambient temperatures between -30°C and 65°C for SSD, and between -10°C and 45°C for HDD.
- DO NOT LEAVE THIS DEVICE IN AN ENVIRONMENT WHERE THE STORAGE TEMPERATURE MAY GO BELOW -40°C OR ABOVE 85°C. This could damage the device. The device must be used in a controlled environment.

Care for your iBASE products:

- Before cleaning the device, turn it off and unplug all cables such as power in case a small amount of electrical current may still flow.
- Use neutral cleaning agents or diluted alcohol to clean the device chassis with a cloth. Then wipe the chassis with a dry cloth.
- Vacuum the dust with a computer vacuum cleaner to prevent the air vent or slots from being clogged.



WARNING

Attention during use:

- Do not use this product near water.
- Do not spill water or any other liquids on your device.
- Do not place heavy objects on the top of the device.
- Operate this device from the type of power indicated on the marking label. If you are not sure of the type of power available, consult your distributor or local power company.
- Do not walk on the power cord or allow anything to rest on it.
- If you use an extension cord, make sure that the total ampere rating of the product plugged into the extension cord does not exceed its limits.

Avoid Disassembly

Do not disassemble, repair or make any modification to the device. Disassembly, modification, or any attempt at repair could generate hazards and cause damage to the device, even bodily injury or property damage, and will void any warranty.



CAUTION

Danger of explosion if internal lithium-ion battery is replaced by an incorrect type. Replace only with the same or equivalent type recommended by the manufacturer. Dispose of used batteries according to the manufacturer's instructions.

Warranty Policy

- **IBASE standard products:**

24-month (2-year) warranty from the date of shipment. If the date of shipment cannot be ascertained, the product serial numbers can be used to determine the approximate shipping date.
- **3rd-party parts:**

12-month (1-year) warranty from delivery for the 3rd-party parts that are not manufactured by IBASE, such as CPU, memory, HDD, power adapter, panel and touchscreen.
- * PRODUCTS, HOWEVER, THAT FAILS DUE TO MISUSE, ACCIDENT, IMPROPER INSTALLATION OR UNAUTHORIZED REPAIR SHALL BE TREATED AS OUT OF WARRANTY AND CUSTOMERS SHALL BE BILLED FOR REPAIR AND SHIPPING CHARGES.

Technical Support & Services

1. Visit the IBASE website at www.ibase.com.tw to find the latest information about the product.
2. If you need any further assistance from your distributor or sales representative, prepare the following information of your product and elaborate upon the problem.
 - Product model name
 - Product serial number
 - Detailed description of the problem
 - The error messages in text or in screenshots if there is any
 - The arrangement of the peripherals
 - Software in use (such as OS and application software, including the version numbers)
3. If repair service is required, you can download the RMA form at <http://www.ibase.com.tw/english/Supports/RMAService/>. Fill out the form and contact your distributor or sales representative.

Table of Contents

| | |
|--|------------|
| Compliance | iii |
| Important Safety Information | iv |
| WARNING | iv |
| CAUTION | v |
| Warranty Policy | v |
| Technical Support & Services | v |
| Chapter 1 General Information | 1 |
| 1.1 Introduction | 2 |
| 1.2 Features..... | 2 |
| 1.3 Packing List | 3 |
| 1.4 Optional Accessories | 3 |
| 1.5 Specifications..... | 4 |
| 1.6 Overview..... | 6 |
| 1.7 Dimensions | 7 |
| Chapter 2 Hardware Configuration | 8 |
| 2.1 Installation / Replacement..... | 9 |
| 2.1.1 Memory Installation / Replacement..... | 9 |
| 2.1.2 Mini PCIe Card Installation / Replacement..... | 10 |
| 2.1.3 HDD/SSD Installation / Replacement..... | 11 |
| 2.1.4 WiFi / 3G / 4G Antenna Installation..... | 11 |
| 2.1.5 Mounting Installation..... | 12 |
| 2.2 Pinout for DC Power Input Connector | 12 |
| 2.3 Setting the Jumpers | 13 |
| 2.3.1 How to Set Jumpers | 13 |
| 2.4 Jumper & Connector Locations on Motherboard | 14 |
| 2.5 Jumpers Quick Reference..... | 15 |
| 2.5.1 LVDS Panel Brightness Selection (JP1, JP4) | 15 |
| 2.5.2 LVDS Panel Power Selection (JP2, JP3)..... | 15 |
| 2.5.3 LCD Panel Backlight VCC (JP5, JP6)..... | 15 |
| 2.5.4 ATX / AT Power Selection (JP7)..... | 16 |
| 2.5.5 Clearing CMOS Data (JP8)..... | 16 |
| 2.5.6 Clearing ME Register (JP9) | 16 |

| | | |
|--|--|-----------|
| 2.6 | Connectors Quick Reference | 17 |
| 2.6.1 | LCD Backlight Connector (J3, J6)..... | 17 |
| 2.6.2 | LVDS Connector (CH1: J4, J5, CH2: J1, J2) | 18 |
| 2.6.3 | Audio Connector (J7)..... | 18 |
| 2.6.4 | USB 2.0 Connector (J10)..... | 18 |
| 2.6.5 | Amplifier Connector (J9) | 19 |
| 2.6.6 | SATA HDD Power Connector (J12) | 19 |
| 2.6.7 | COM2 / COM3 / COM4 RS-232 Port (J18, J19, J14) | 19 |
| 2.6.8 | Front Panel Connector (J16)..... | 19 |
| 2.6.9 | Digital I/O Connector (J22) | 20 |
| 2.6.10 | DC Power Input (J21) | 20 |
| 2.6.11 | COM1 RS-232/422/435 (CN10)..... | 20 |
| Chapter 3 Driver Installation | | 21 |
| 3.1 | Introduction | 22 |
| 3.2 | Intel® Chipset Software Installation Utility | 22 |
| 3.3 | Intel® Graphics Driver Installation | 24 |
| 3.4 | HD Audio Driver Installation | 25 |
| 3.5 | Intel® Trusted Execution Engine Installation | 26 |
| 3.6 | Intel® Serial I/O Drivers Installation | 28 |
| 3.7 | LAN Driver Installation | 29 |
| Chapter 4 BIOS Setup | | 31 |
| 4.1 | Introduction | 32 |
| 4.2 | BIOS Setup..... | 32 |
| 4.3 | Main Settings | 33 |
| 4.4 | Advanced Settings | 34 |
| 4.4.1 | ACPI Settings | 34 |
| 4.4.2 | LFP (eDP) to LVDS Configuration | 35 |
| 4.4.3 | EFP (DP) to LVDS Configuration | 36 |
| 4.4.4 | Fintek Super IO Configuration | 37 |
| 4.4.5 | Fintek Super I/O Hardware Monitor | 39 |
| 4.4.6 | CPU Configuration..... | 40 |
| 4.4.7 | AMI Graphic Output Protocol Policy..... | 41 |
| 4.4.8 | Network Stack Configuration | 42 |
| 4.4.9 | CSM Configuration | 43 |
| 4.4.10 | USB Configuration..... | 44 |
| 4.5 | Chipset Settings..... | 45 |
| 4.5.1 | North Bridge | 45 |
| 4.5.2 | South Cluster Configuration..... | 46 |

iBASE

| | | |
|-----------------------|-------------------------------------|-----------|
| 4.6 | Security Settings | 50 |
| 4.7 | Boot Settings..... | 51 |
| 4.8 | Save & Exit Settings..... | 52 |
| Appendix | | 53 |
| A. | I/O Port Address Map..... | 54 |
| B. | Interrupt Request Lines (IRQ) | 56 |
| C. | Watchdog Timer Configuration..... | 57 |

Chapter 1

General Information

The information provided in this chapter includes:

- Features
- Packing List
- Specifications
- Overview
- Dimensions

1.1 Introduction

The CSB200-818 is applicable to thin clients, smart industrial automation or controller, and retail equipment. It is slim and fanless with an Intel® Atom™ E3930 / Pentium® N4200 / Celeron® N3350 processor. This system is built with an easily removable HDD at the bottom and features rich peripheral ports for data transmission or receiving. The power connector is a 3-pin terminal block by default but a DC jack is available for option too.



1.2 Features

- Fanless system with IBASE IB818 3.5" disk-size SBC
- Onboard Intel® Atom™ processors E3930 / Pentium® N4200 / Celeron® N3350 Series
- Wide-range operating temperature from -30°C to 65°C
- 12V ~ 24V DC power input
- Wall mount kit included

1.3 Packing List

Your product package should include the items listed below. If any of the items below is missing, contact the distributor or the dealer from whom you purchased the product.

- CSB200-818 x 1
- Wall Mount Kit (2 brackets) x 1
- Screws for Wall Mount Kit x 4
- 3-Pin Female Terminal Block x 1
(For power connector. If the optional DC Jack is used, this terminal block will not be enclosed.)
- DVD Disk (including drivers) x 1
- Motherboard IB818 User's Manual x 1
(You can download CSB200-818 User's Manual from our website.)

1.4 Optional Accessories

IBASE provide optional accessories as follows. Please contact us or your dealer if you need any.

- 12V Power Adapter
- Power Cord

1.5 Specifications

| | |
|-------------------------------|--|
| Product Name | CSB200-818 |
| System | |
| Motherboard | IB818F 3.5" disk-size SBC |
| Operating System | <ul style="list-style-type: none"> • Windows 10 Enterprise (64-bit) • Windows 10 IoT Core (64-bit) • Linux Ubuntu |
| CPU | Intel® Atom™ DC Processor E3930 / Pentium® N4200 / Celeron® N3350 Series |
| System Speed | Up to 2.5 GHz |
| Chipset | Integrated |
| Memory | 1 x DDR3L-1866 SO-DIMM 4 GB, expandable to 8 GB |
| Graphics | Intel® SoC integrated Gen. 9 |
| Super I/O | Fintek F81964D-I |
| Storage | 1 x 2.5" HDD or SSD (removable from the bottom) |
| Audio Codec | Intel® SoC built-in HD audio controller Realtek ALC283QHD codec with speaker amplifier |
| Network | Intel® I210IT / I211AT GbE LAN |
| Power Supply | 60W power adaptor (Optional) |
| BIOS | AMI BIOS |
| Watchdog | Watchdog Timer 256 segments, 0, 1, 2...255 sec/min |
| Chassis | Aluminum & steel, black |
| Mounting | Desktop or wall mount (wall mount kit is included.) |
| Dimensions (W x H x D) | 172 x 53 x 111.6 mm (6.77" x 2.09" x 4.39") |
| Net Weight | 1.1 kg (2.43 lb) |
| Certificate | CE / LVD / FCC Class B |
| I/O Ports | |
| DC Input | Terminal block for 12V ~ 24V DC-In (DC Jack type is optional.) |
| LAN | 2 x RJ45 GbE LAN |
| USB | <ul style="list-style-type: none"> • 4 x USB 3.0 • 2 x USB 2.0 |
| Serial | 4 x COM ports: <ul style="list-style-type: none"> • COM1 RS-232/422/485 port • COM2, COM3, COM4 RS-232 ports |

| | |
|-----------------------------|---|
| Display | 1 x HDMI Port |
| Audio Jack | <ul style="list-style-type: none"> • 1 x Microphone Input • 1 x Line-Out |
| SATA | 2 x SATA III connector |
| Expansion | <ul style="list-style-type: none"> • 1 x Mini PCIe slot (full-sized, with USB 2.0 and SATA) • 1 x Mini PCIe slot (half-sized, with USB 2.0) |
| Environment | |
| Temperature | <ul style="list-style-type: none"> • Operating: (With air flow) For N-Series CPU, with HDD: -10 ~ 45 °C (14 ~ 113 °F) For E3930 CPU, with SSD: -30 ~ 65 °C (22 ~ 149 °F) • Storage: -40~ 85 °C (-40 ~ 185 °F) |
| Relative Humidity | 5 ~ 90% at 45 °C (non-condensing) |
| Vibration Protection | <ul style="list-style-type: none"> • Operating: 1.0 Grms / 5 ~ 500 Hz, random operation • Non-operating: 2.0 Grms / 5 ~ 500Hz, random operation |
| Shock Protection | <ul style="list-style-type: none"> • Operating: 20 g / 11 ms • Non-operating: 30 g / 11 ms |

All specifications are subject to change without prior notice.

1.6 Overview

Front View

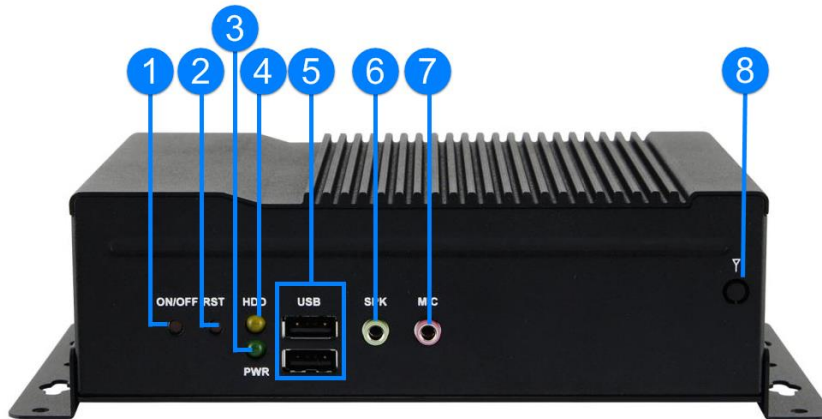

| No. | Name | No. | Name |
|-----|---------------------|-----|-----------------------|
| 1 | Power Button | 5 | USB 2.0 Ports |
| 2 | Reset Button | 6 | Audio Line-Out Jack |
| 3 | Power LED Indicator | 7 | Microphone Input Jack |
| 4 | HDD LED Indicator | 8 | Antenna Hole |

Rear View

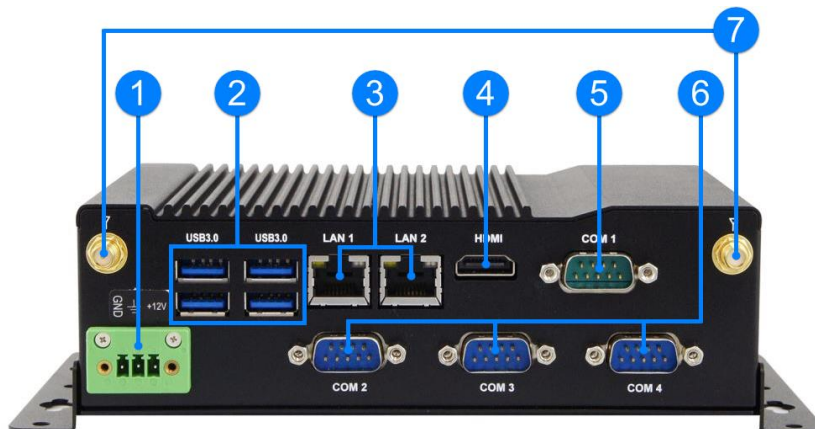

| No. | Name | No. | Name |
|-----|-----------------------|-----|--------------------------|
| 1 | DC-In Power Connector | 5 | COM1 RS-232/422/485 Port |
| 2 | USB 3.0 Ports | 6 | COM2 ~ COM4 RS-232 Ports |
| 3 | GbE LAN Ports | 7 | Antenna Holes |
| 4 | HDMI Port | 8 | |

Oblique View



1.7 Dimensions

Unit: mm

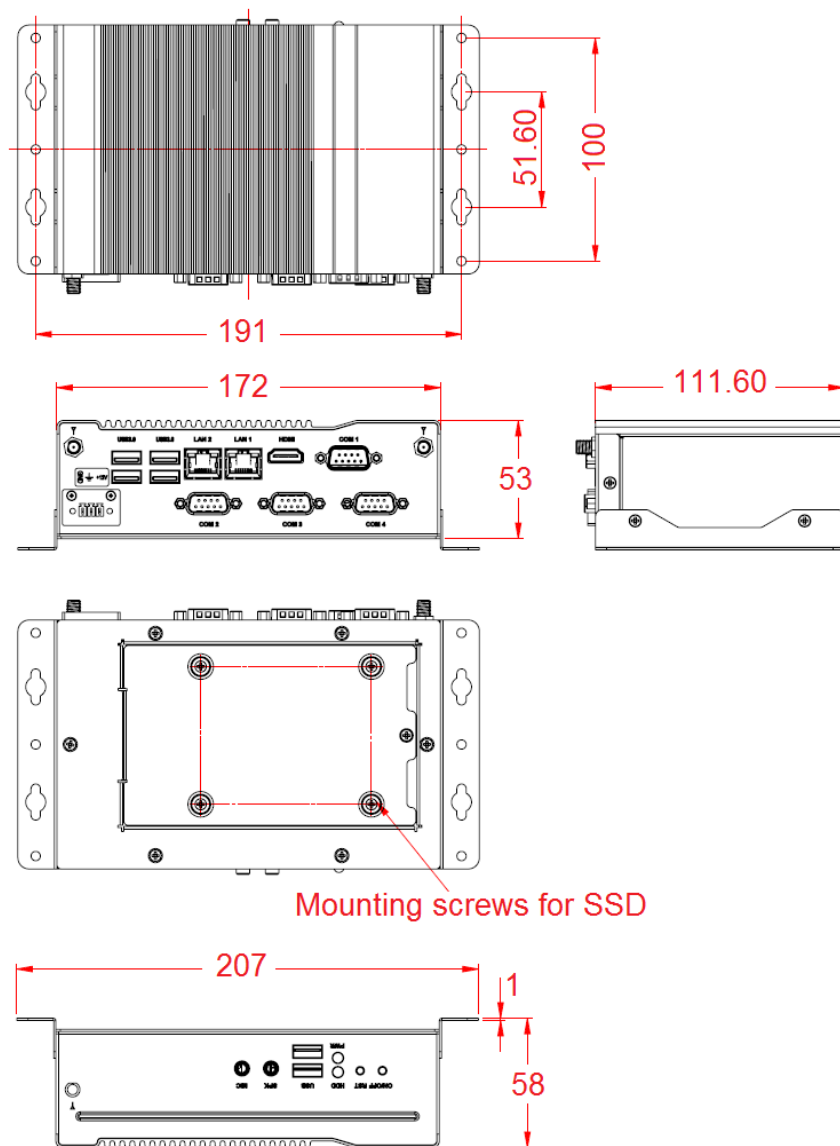

Chapter 2

Hardware Configuration

The information provided in this chapter includes:

- Installation / Replacement
- Information and locations of connectors

2.1 Installation / Replacement

Before installations, you need to turn your device upside down and remove the bottom chassis base by removing 6 screws as indicated below.

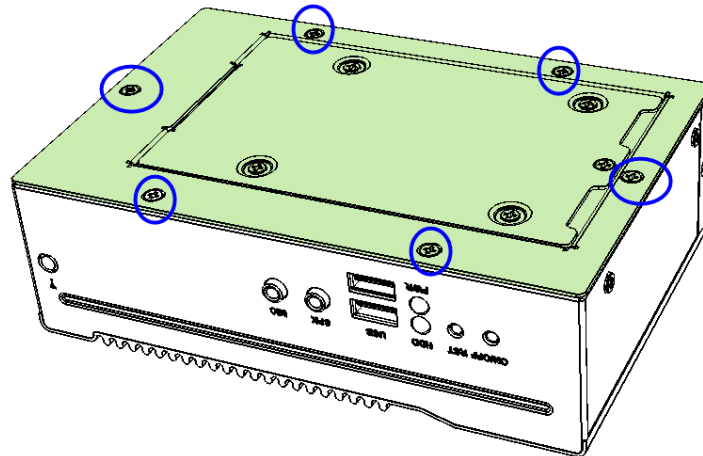

2.1.1 Memory Installation / Replacement

If you need to install or replace a memory module, you will have to remove the interior plate carrying a small PCB with I/O module locating above the memory slot as shown below. Follow the instructions to remove the plate.

1. Loosen the 3 screws to free up interior plate.

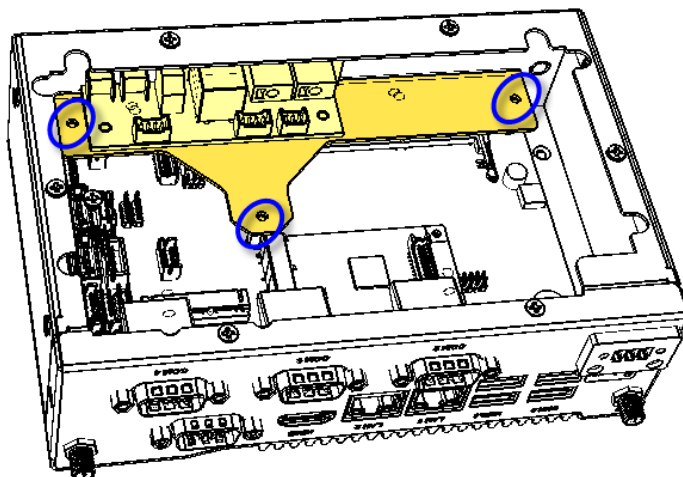

2. Take out the interior plate along with the small PCB and I/O module carefully.
3. Align the key of your memory module with that on the memory slot and insert the module slantwise.

4. Gently push the module in an upright position until the clips of the slot click to hold the module in place when the module touches the bottom of the slot.

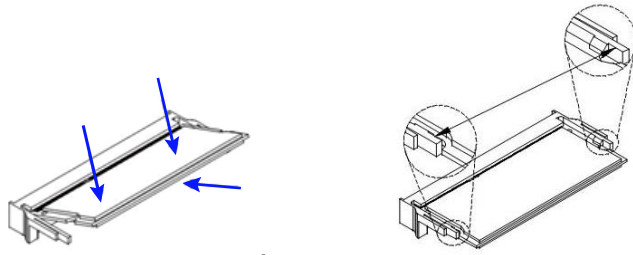

To remove the module, press the clips outwards with your thumb and index finger of both hands.

2.1.2 Mini PCIe Card Installation / Replacement

If you are using a model type of CSB200-818 that doesn't include a mini-PCIe card, follow the instructions below to install a mSATA card.

1. Loosen 6 screws to from the bottom chassis and remove it carefully.
2. Locate the half-size or full-size mini-PCIe slot.
3. Align the key of your mini PCIe card to the interface, and insert the card slantwise.

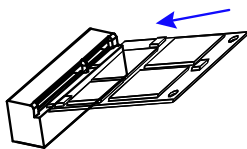

4. Push the card down and fix it with the a screw..

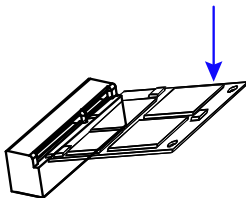

5. Secure the bottom chassis back.

2.1.3 HDD/SSD Installation / Replacement

1. Remove one screw as indicated below to remove the HDD/SSD plate.

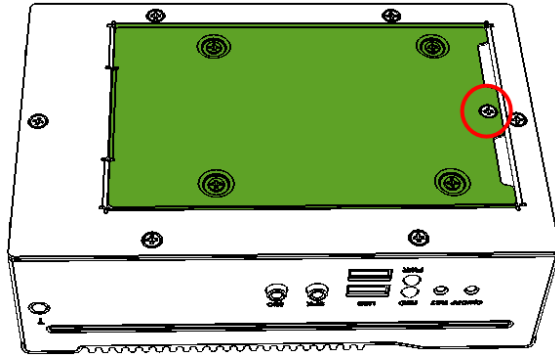

2. Remove 4 screws to free the HDD/SSD from the plate.
3. Unplug all the SATA cables if a HDD/SSD is pre-installed.
4. Attach a new HDD/SSD and tighten these screws to fix the HDD/SSD. Then connect the SATA cables.

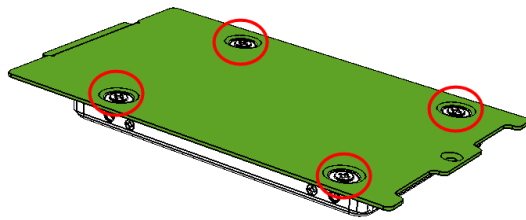

5. Secure the plate along with the new HDD/SSD back to the system.

2.1.4 WiFi / 3G / 4G Antenna Installation

Thread the WiFi / 3G / 4G antenna extension cable through an antenna hole of the front I/O cover and fasten the antenna as shown below. Then apply adhesive to the edge of the hex nut behind the front I/O cover to prevent the extension cable from falling if the cable becomes loose.

1. Thread and fasten the hex nut and the washer. Then install the antenna.
2. Apply adhesive around here.

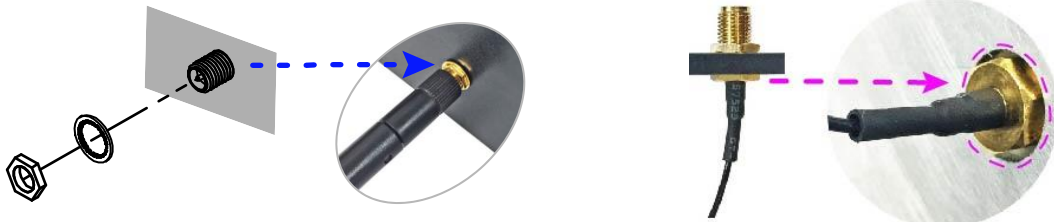

Info: The diameter of the nut is around 6.35 mm (0.25"-36UNC).

2.1.5 Mounting Installation

Requirements

Before mounting the system, ensure that you have enough room for the power adaptor and signal cable routing, and have good ventilation for the power adaptor. The method of mounting must be able to support weight of the product plus the weight of the suspending cables attached to the system. Use the following methods for mounting your system:

Wall Mounting Installation

1. Attach the mounting kit (2 brackets) to the your product, and secure with the supplied four screws as below.

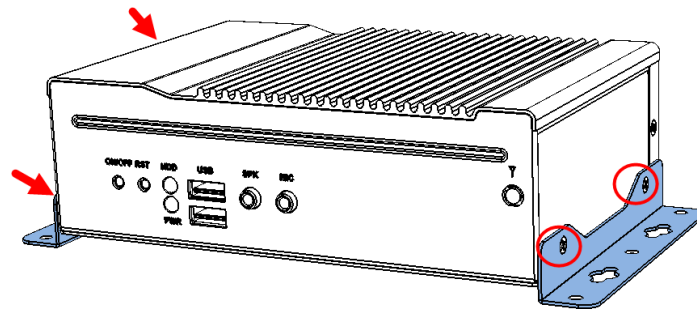

2. Then prepare at least four screws (M3, 6 mm) to mount the device on wall .

2.2 Pinout for DC Power Input Connector

- DC Power Input (terminal block)

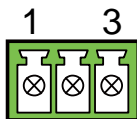

| Pin | Signal Name | Pin | Signal Name |
|-----|-------------|-----|-------------|
| 1 | GND | 3 | 12V~24V |
| 2 | Chassis GND | | |

2.3 Setting the Jumpers

Set up and configure your CSB200-898 by using jumpers for various settings and features according to your needs and applications. Contact your supplier if you have doubts about the best configuration for your use.

2.3.1 How to Set Jumpers

Jumpers are short-length conductors consisting of several metal pins with a non-conductive base mounted on the circuit board. Jumper caps are used to have the functions and features enabled or disabled. If a jumper has 3 pins, you can connect either PIN1 to PIN2 or PIN2 to PIN3 by shorting.

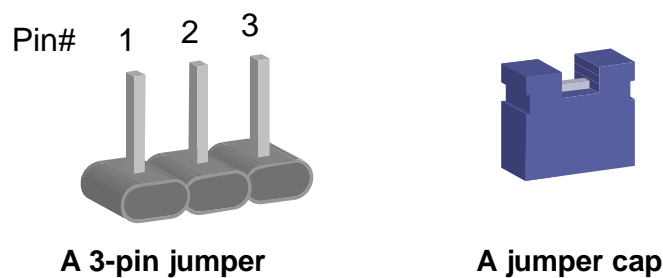

Refer to the illustration below to set jumpers.

| Pin closed | Oblique view | Schematic illustration in the manual |
|------------|--------------|--------------------------------------|
| Open | | |
| 1-2 | | |
| 2-3 | | |

When two pins of a jumper are encased in a jumper cap, this jumper is **closed**, i.e. turned **On**.

When a jumper cap is removed from two jumper pins, this jumper is **open**, i.e. turned **Off**.

2.4 Jumper & Connector Locations on Motherboard

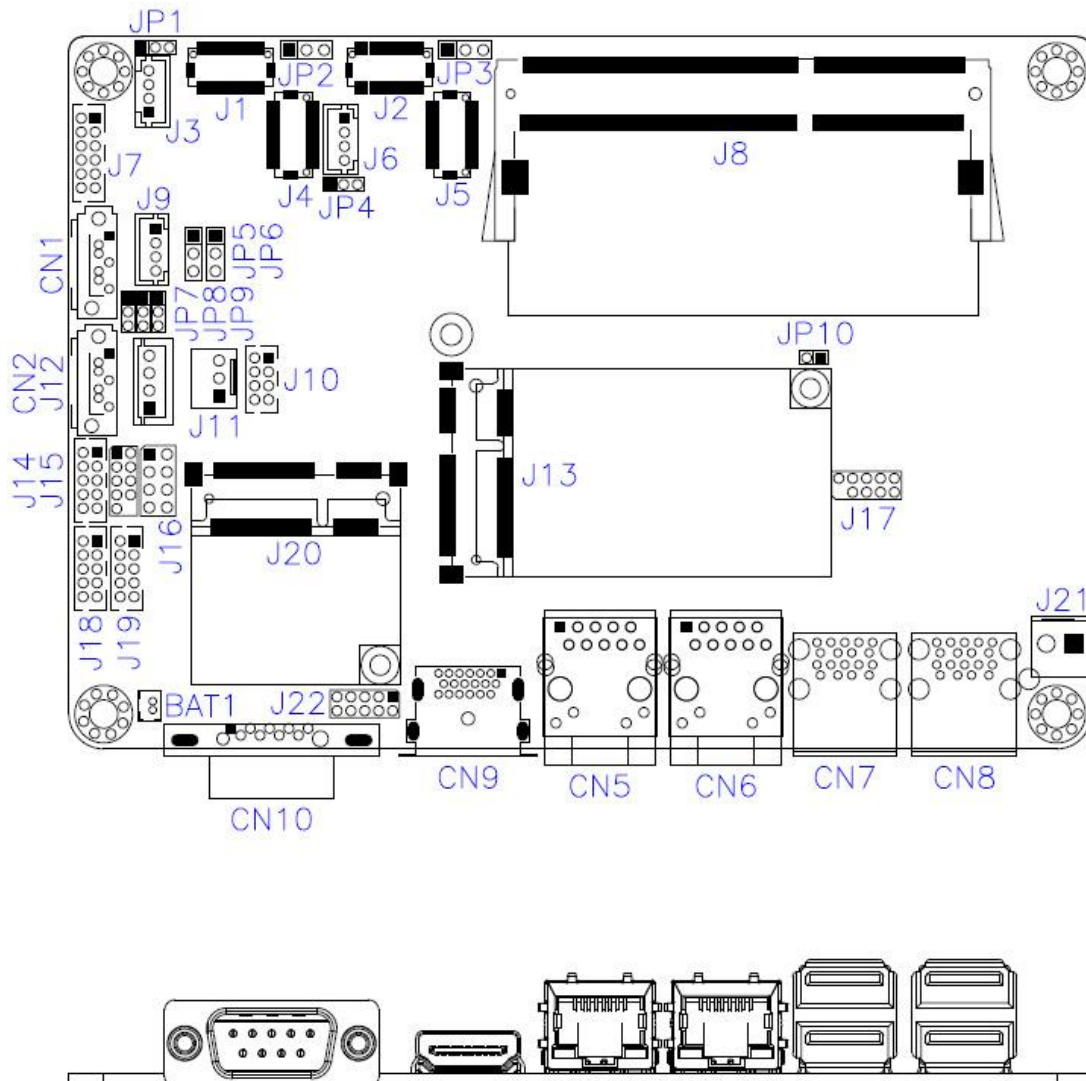

Motherboard: IB818F





2.5 Jumpers Quick Reference

| Function | Connector Name | Page |
|--------------------------------|----------------|------|
| LCD Panel Brightness Selection | JP1, JP4 | 15 |
| LVDS Panel Power Selection | JP2, JP3 | 15 |
| LCD Panel Backlight VCC | JP5, JP6 | 15 |
| ATX / AT Power Selection | JP7 | 16 |
| Clearing CMOS Data | JP8 | 16 |
| Clearing ME Register | JP9 | 16 |
| Factory Use Only | JP10 | -- |



2.5.1 LVDS Panel Brightness Selection (JP1, JP4)

| Function | Pin closed | Illustration |
|----------------|------------|---|
| 3.3V (default) | 1-2 | 1  |
| 5V | 2-3 | 1  |

2.5.2 LVDS Panel Power Selection (JP2, JP3)

| Function | Pin closed | Illustration |
|----------------|------------|---|
| 3.3V (default) | 1-2 | 1  |
| 5V | 2-3 | 1  |



2.5.3 LCD Panel Backlight VCC (JP5, JP6)

| Function | Pin closed | Illustration |
|--------------|------------|---|
| 5V (default) | 1-2 | 1  |
| 12V | 2-3 | 1  |

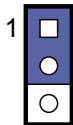
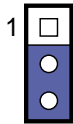

2.5.4 ATX / AT Power Selection (JP7)

| Function | Pin closed | Illustration |
|---------------|------------|---|
| ATX (default) | 1-2 |  |
| AT | 2-3 |  |

2.5.5 Clearing CMOS Data (JP8)

| Function | Pin closed | Illustration |
|------------------|------------|---|
| Normal (default) | 1-2 |  |
| Clear CMOS | 2-3 |  |

2.5.6 Clearing ME Register (JP9)

| Function | Pin closed | Illustration |
|------------------|------------|---|
| Normal (default) | 1-2 |  |
| Clear ME | 2-3 |  |

2.6 Connectors Quick Reference

| Function | Connector Name | Page |
|---------------------------|----------------------------|------|
| SATA III | CN1, CN2 | -- |
| LAN Ports | CN5, CN6 | -- |
| USB 3.0 | CN7, CN8 | -- |
| HDMI | CN9 | -- |
| LCD Backlight | J3,J6 | 17 |
| LVDS | CH1: J4, J5 CH2: J1, J2 | 18 |
| Audio | J7 | 18 |
| DDR3L SO-DIMM | J8 | -- |
| USB 2.0 | J10 | 18 |
| Amplifier | J9 | 19 |
| SATA HDD Power | J12 | 19 |
| COM2 / COM3 / COM4 RS-232 | J18, J19, J14 | 19 |
| Mini PCIe / mSATA | J13 (shared with CN2) | -- |
| Mini PCIe | J20 | -- |
| Front Panel | J16 | 19 |
| COM Digital I/O | J22 | 20 |
| DC Power Input | J21 | 20 |
| COM1 RS-232/422/485 | CN10 | 20 |
| Factory Use Only | J17,J15 | -- |

2.6.1 LCD Backlight Connector (J3, J6)

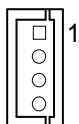

| Pin | Signal Name | Pin | Signal Name |
|-----|------------------|-----|--------------------|
| 1 | +12V / +5V | 3 | Brightness Control |
| 2 | Backlight Enable | 4 | Ground |

2.6.2 LVDS Connector (CH1: J4, J5, CH2: J1, J2)

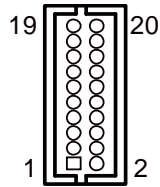

| Pin | Signal Name | Pin | Signal Name |
|-----|-------------|-----|-------------|
| 1 | TX0P | 2 | TX0N |
| 3 | Ground | 4 | Ground |
| 5 | TX1P | 6 | TX1N |
| 7 | Ground | 8 | Ground |
| 9 | TX2P | 10 | TX2N |
| 11 | Ground | 12 | Ground |
| 13 | CLKP | 14 | CLKN |
| 15 | Ground | 16 | Ground |
| 17 | TX3P | 18 | TX3N |
| 19 | VDD | 20 | VDD |

2.6.3 Audio Connector (J7)

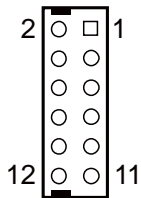

| Pin | Signal Name | Pin | Signal Name |
|-----|-------------|-----|-------------|
| 1 | Lineout_L | 2 | Lineout_R |
| 3 | JD_FRONT | 4 | Ground |
| 5 | LINEIN_L | 6 | Linein_R |
| 7 | JD_LINEIN | 8 | Ground |
| 9 | MIC_L | 10 | MIC-R |
| 11 | JD_MIC1 | 12 | Ground |

2.6.4 USB 2.0 Connector (J10)

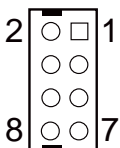

| Pin | Signal Name | Pin | Signal Name |
|-----|-------------|-----|-------------|
| 1 | VCC | 2 | Ground |
| 3 | D0- | 4 | D1+ |
| 5 | D0+ | 6 | D1- |
| 7 | Ground | 8 | VCC |

2.6.5 Amplifier Connector (J9)

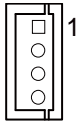

| Pin | Signal Name | Pin | Signal Name |
|-----|-------------|-----|-------------|
| 1 | OUTL+ | 3 | OUTR- |
| 2 | OUTL- | 4 | OUTR+ |

2.6.6 SATA HDD Power Connector (J12)

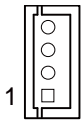

| Pin | Signal Name | Pin | Signal Name |
|-----|-------------|-----|-------------|
| 1 | +5V | 3 | Ground |
| 2 | Ground | 4 | +12V |

2.6.7 COM2 / COM3 / COM4 RS-232 Port (J18, J19, J14)

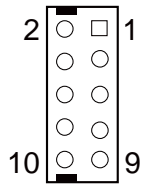

| Pin | Signal Name | Pin | Signal Name |
|-----|--------------------------|-----|--------------------------|
| 1 | DCD, Data carrier detect | 2 | RXD, Receive data |
| 3 | TXD, Transmit data | 4 | DTR, Data terminal ready |
| 5 | Ground | 6 | DSR, Data set ready |
| 7 | RTS, Request to send | 8 | CTS, Clear to send |
| 9 | RI, Ring indicator | 10 | Not Used |

2.6.8 Front Panel Connector (J16)

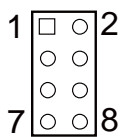

| Pin | Signal Name | Pin | Signal Name |
|-----|-------------|-----|-------------|
| 1 | Ground | 2 | PWR_BTN |
| 3 | 3.3V | 4 | HDD Active |
| 5 | Ground | 6 | Reset |
| 7 | +5V | 8 | Ground |

2.6.9 Digital I/O Connector (J22)

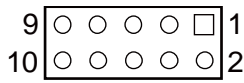

| Pin | Signal Name | Pin | Signal Name |
|-----|-------------|-----|-------------|
| 1 | Ground | 2 | VCC |
| 3 | OUT3 | 4 | OUT1 |
| 5 | OUT2 | 6 | OUT0 |
| 7 | IN3 | 8 | IN1 |
| 9 | IN2 | 10 | IN0 |

2.6.10 DC Power Input (J21)



| Pin | Signal Name | Pin | Signal Name |
|-----|-------------|-----|-------------|
| 1 | +12V ~ +24V | 2 | Ground |

2.6.11 COM1 RS-232/422/435 (CN10)

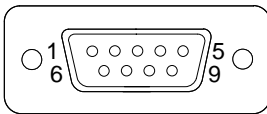

| Pin | Signal Name | Pin | Signal Name |
|-----|--------------------------|-----|----------------------|
| 1 | DCD, Data carrier detect | 6 | DSR, Data set ready |
| 2 | RXD, Receive data | 7 | RTS, Request to send |
| 3 | TXD, Transmit data | 8 | CTS, Clear to send |
| 4 | DTR, Data terminal ready | 9 | RI, Ring indicator |
| 5 | Ground | | |

| Pin | Signal Name | | |
|-----|-------------|--------|--------|
| | RS-232 | RS-422 | RS-485 |
| 1 | DCD | TX- | DATA- |
| 2 | RX | TX+ | DATA+ |
| 3 | TX | RX+ | NC |
| 4 | DTR | RX- | NC |
| 5 | Ground | Ground | Ground |
| 6 | DSR | NC | NC |
| 7 | RTS | NC | NC |
| 8 | CTS | NC | NC |
| 9 | RI | NC | NC |

Chapter 3

Driver Installation

The information provided in this chapter includes:

- Intel® Chipset Software Installation Utility
- Intel® Graphics Driver
- HD Audio Driver
- Intel® Trusted Execution Engine Installation
- Intel® Serial I/O Drivers
- LAN Driver

3.1 Introduction

This section describes the installation procedures for software drivers. The software drivers are in a disk enclosed with the product package. If you find anything missing, please contact the distributor where you made the purchase.

Note: After installing your Windows operating system, you must install the Intel® Chipset Software Installation Utility first before proceeding with the drivers installation.

3.2 Intel® Chipset Software Installation Utility

The Intel® Chipset drivers should be installed first before the software drivers to install INF files for Plug & Play function for the chipset components. Follow the instructions below to complete the installation.

1. Insert the disk enclosed in the product package. Click **Intel** on the left pane and then **Intel(R) Apollolake Chipset Drivers** on the right.

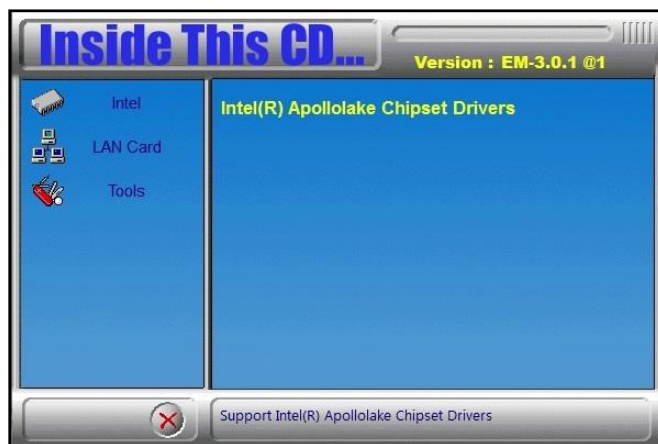

2. Click **Intel(R) Chipset Software Installation Utility**.



3. When the *Welcome* screen to the Intel® Chipset Device Software appears, click **Next** to continue.
4. Click **Yes** to accept the software license agreement and proceed with the installation process.
5. On the *Readme File Information* screen, Click **Install** for installation.

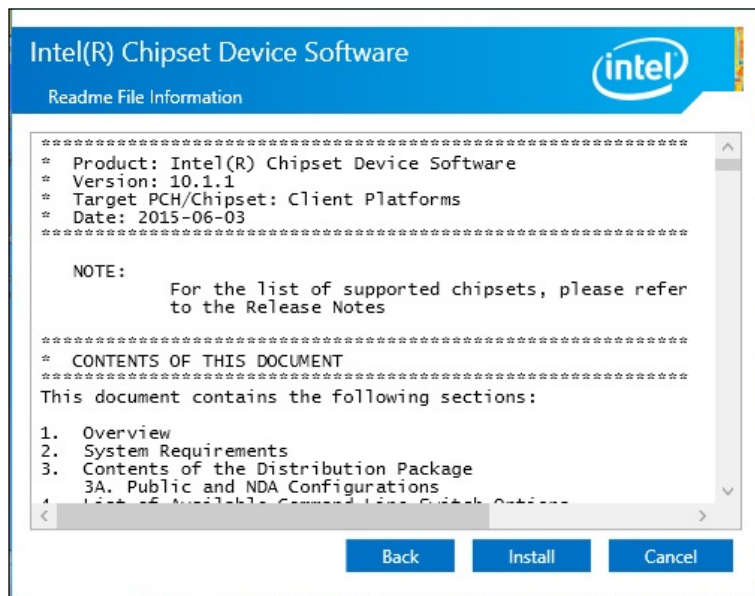

6. After the driver is completely installed, restart the computer for changes to take effect.

3.3 Intel® Graphics Driver Installation

1. Click **Intel** on the left pane and then **Intel(R) Apollolake Chipset Drivers** on the right.

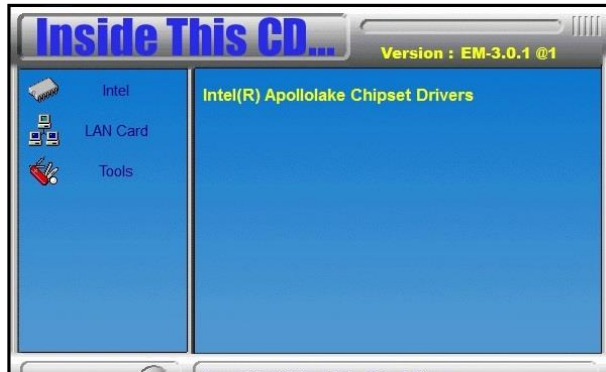

2. Click **Intel(R) Apollolake Graphics Driver**.



3. When the *Welcome* screen appears, click **Next** to continue.

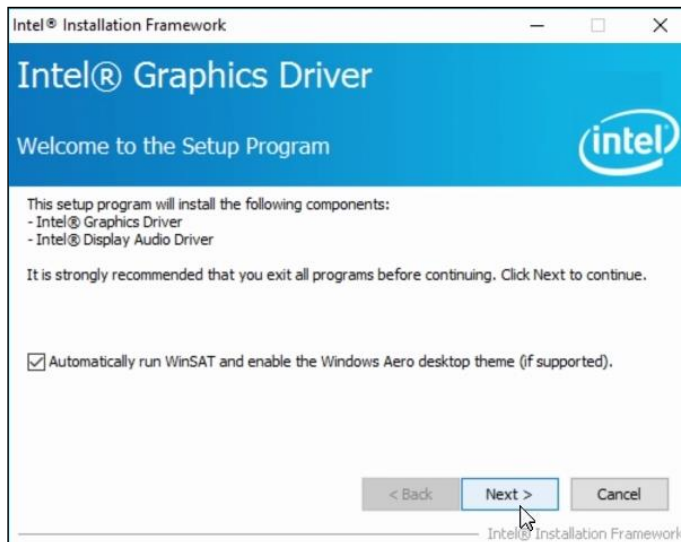

4. Click **Yes** to agree with the license agreement and click **Next** to continue.
5. After the driver is completely installed, restart the computer for changes to take effect.

3.4 HD Audio Driver Installation

1. Click **Intel** on the left and then **Intel(R) Apollolake Chipset Drivers** on the right.



2. Click **Realtek High Definition Audio Driver**.



3. On the *Welcome* screen of the InstallShield Wizard, click **Next**.

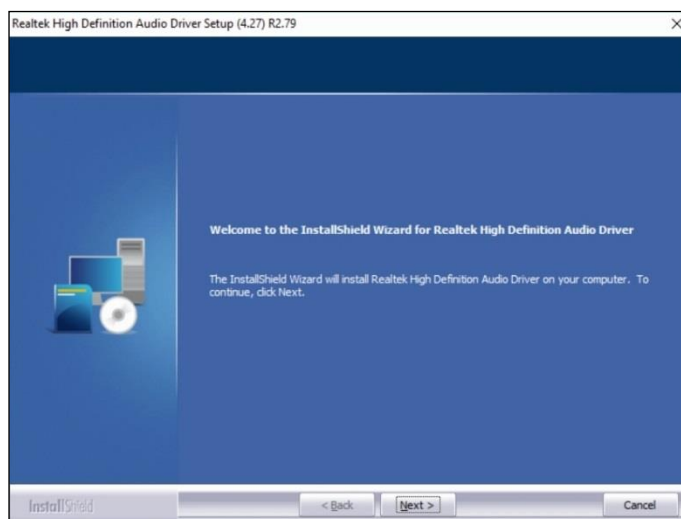

4. Click **Next** until the installation starts.
5. After the driver is completely installed, restart the computer for changes to take effect.

3.5 Intel® Trusted Execution Engine Installation

1. Click **Intel** on the left and then **Intel(R) Apollolake Chipset Drivers**.



2. Click **Intel(R) TXE Drivers**.



3. When the *Welcome* screen appears, click **Next**.

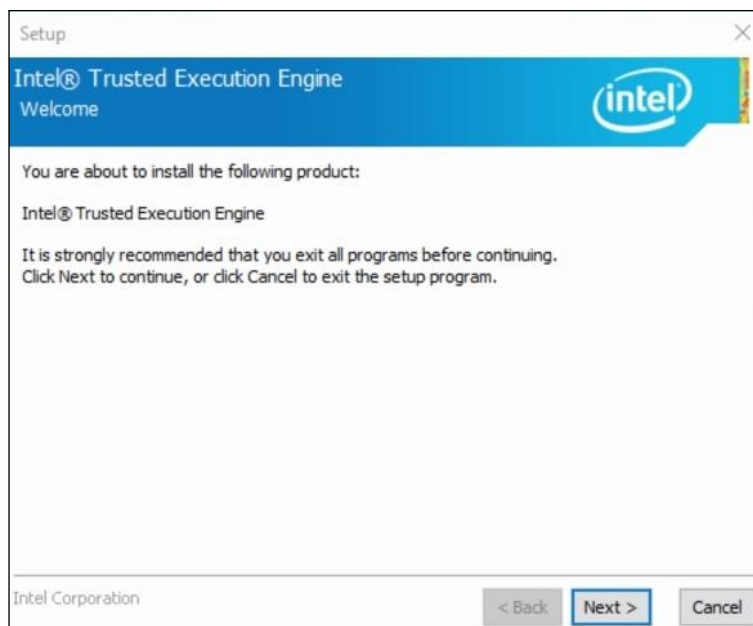

4. Accept the license agreement and click **Next**.
5. Click **Next** until the installation starts.

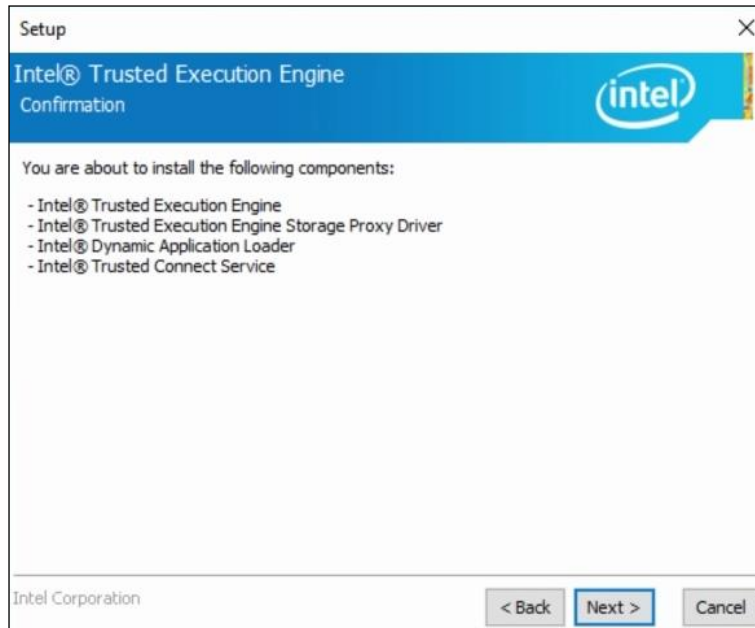

6. After the driver is completely installed, restart the computer for changes to take effect.

3.6 Intel® Serial I/O Drivers Installation

1. Click **Intel** on the left and then **Intel(R) Apollolake Chipset Drivers**.



2. Click **Intel(R) Serial I/O Drivers**.

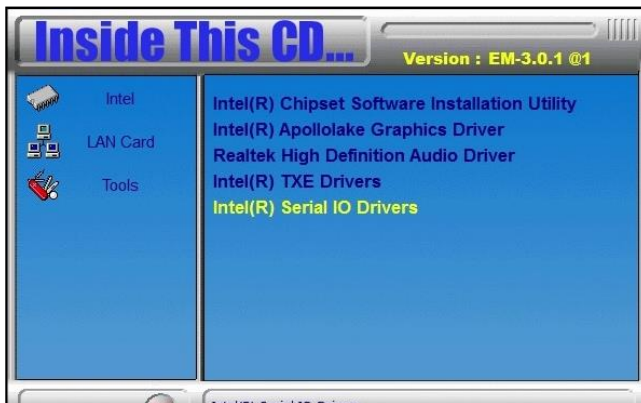

3. On the *Welcome* screen, click **Next**.

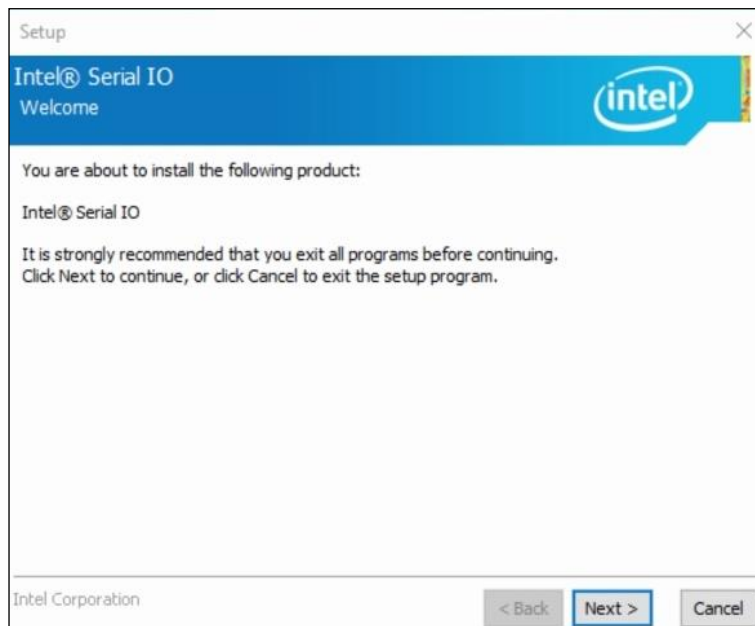

4. Accept the license agreement and click **Next**.
5. After reading the *Readme File Information*, click **Next** for installation.
6. After the driver is successfully installed, restart the computer for changes to take effect.

3.7 LAN Driver Installation

1. Click **LAN Card** on the left and then click **Intel LAN Controller Drivers**.



2. Click **Intel(R) I21x Gigabit Network Drivers**.

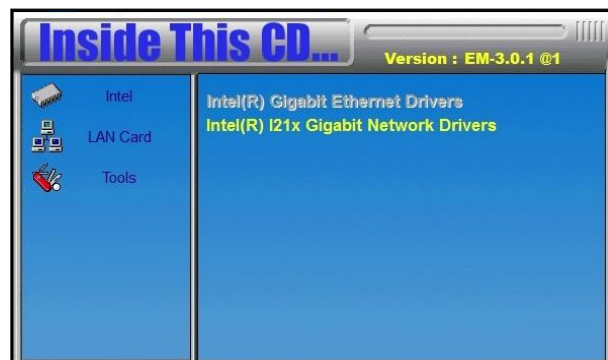

3. When the *Welcome* screen of the InstallShield Wizard appears, click **Next**.

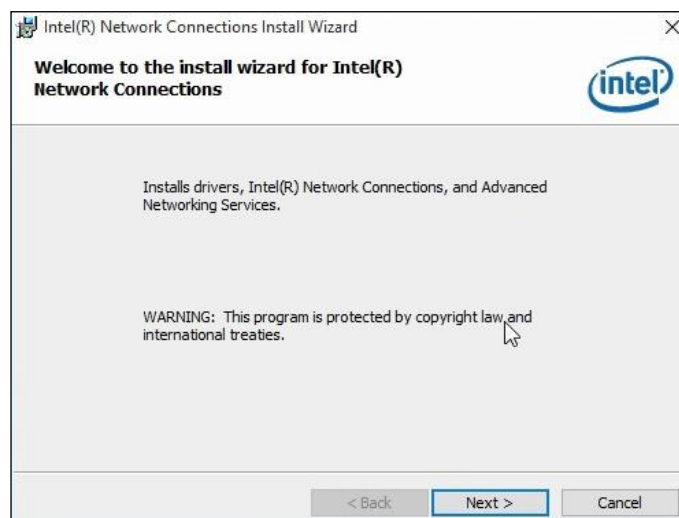

iBASE

4. Accept the license agreement and click **Next**.
5. On the *Setup Options* screen, select the desired driver(s) for installation. Then click **Next** to continue.

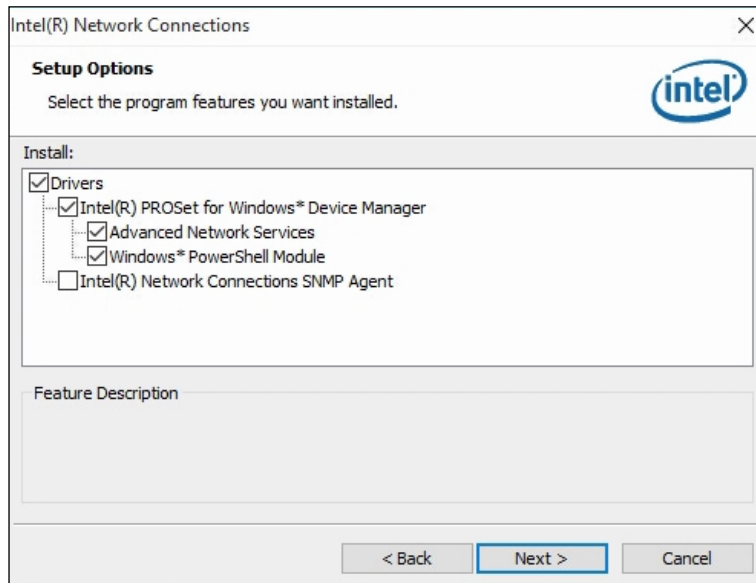

6. When the wizard is ready for installation, click **Install**.
7. When the installation is complete, restart the computer for changes to take effect.

Chapter 4

BIOS Setup

This chapter describes the different settings available in the AMI BIOS that comes with the board. The topics covered in this chapter are as follows:

- Main Settings
- Advanced Settings
- Chipset Settings
- Security Settings
- Boot Settings
- Save & Exit

4.1 Introduction

The BIOS (Basic Input/Output System) installed in the ROM of your computer system supports Intel® processors. The BIOS provides critical low-level support for standard devices such as disk drives, serial ports and parallel ports. It also provides password protection as well as special support for detailed fine-tuning of the chipset controlling the entire system.

4.2 BIOS Setup

The BIOS provides a Setup utility program for specifying the system configurations and settings. The BIOS ROM of the system stores the Setup utility. When you turn on the computer, the BIOS is immediately activated. Press the key immediately to enter the Setup utility and press <F7> to call the pop-up Boot menu. If you are a little bit late pressing the key, POST (Power On Self-Test) will continue with its test routines, thus preventing you from invoking the Setup.

If you still need to enter Setup, restart the system by pressing the "Reset" button or simultaneously pressing the <Ctrl>, <Alt> and <Delete> keys. You can also restart by turning the system Off and back On again.

The following message will appear on the screen:

```
Press <DEL> to Enter Setup
```

In general, press the arrow keys to highlight items, <Enter> to select, the <PgUp> and <PgDn> keys to change entries, <F1> for help, and <Esc> to quit.

When you enter the BIOS Setup utility, the *Main Menu* screen will appear on the screen. The Main Menu allows you to select from various setup functions and exit choices.

Warning: It is strongly recommended that you avoid making any changes to the chipset defaults.

These defaults have been carefully chosen by both AMI and your system manufacturer to provide the absolute maximum performance and reliability. Changing the defaults could make the system unstable and crash in some cases.

4.3 Main Settings

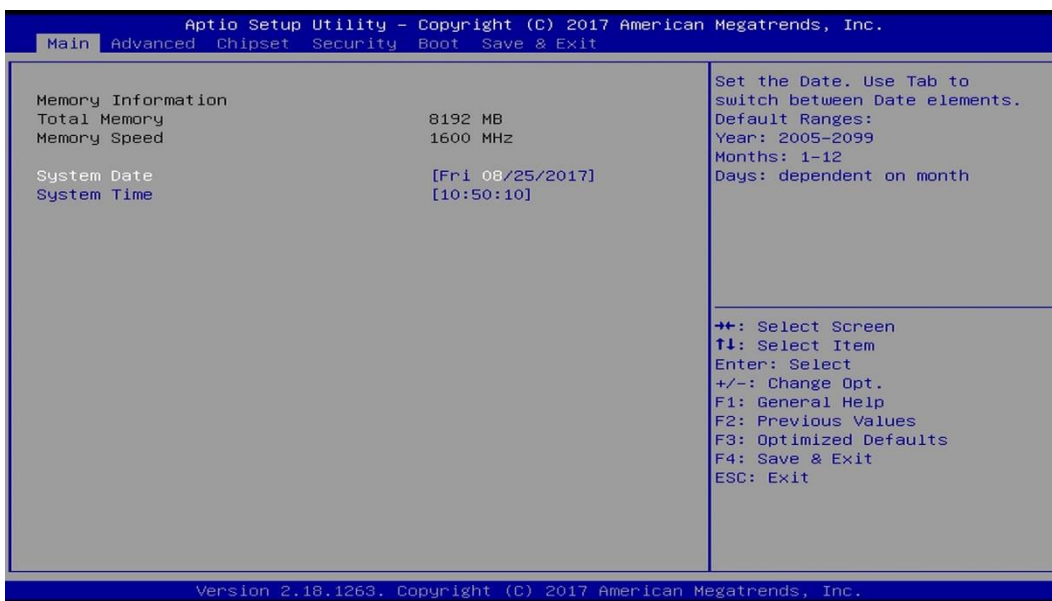

| BIOS Setting | Description |
|--------------|--|
| System Date | Sets the date. Use the <Tab> key to switch between the data elements. |
| System Time | Set the time. Use the <Tab> key to switch between the data elements. |

4.4 Advanced Settings

This section allows you to configure, improve your system and allows you to set up some system features according to your preference.

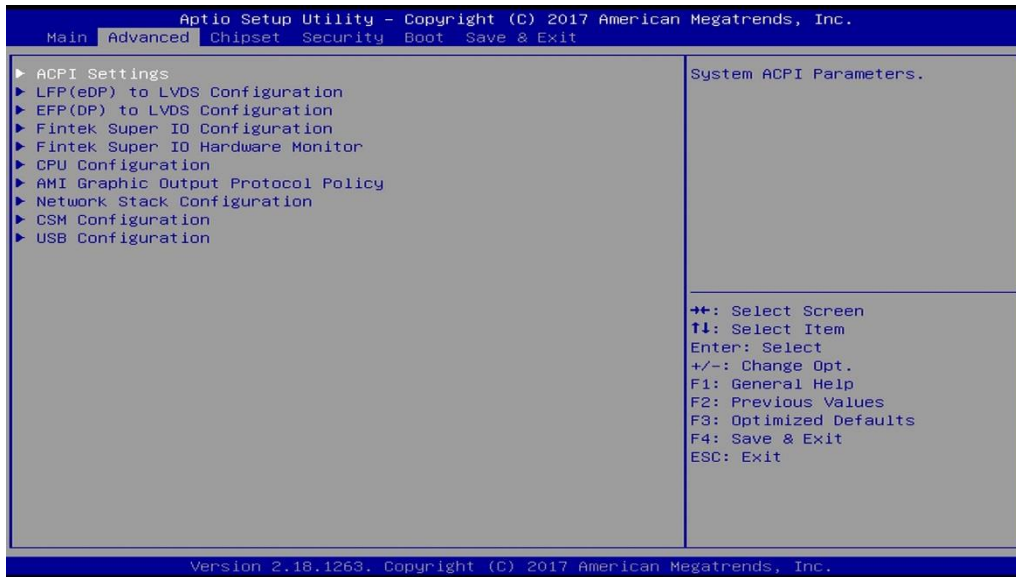

4.4.1 ACPI Settings

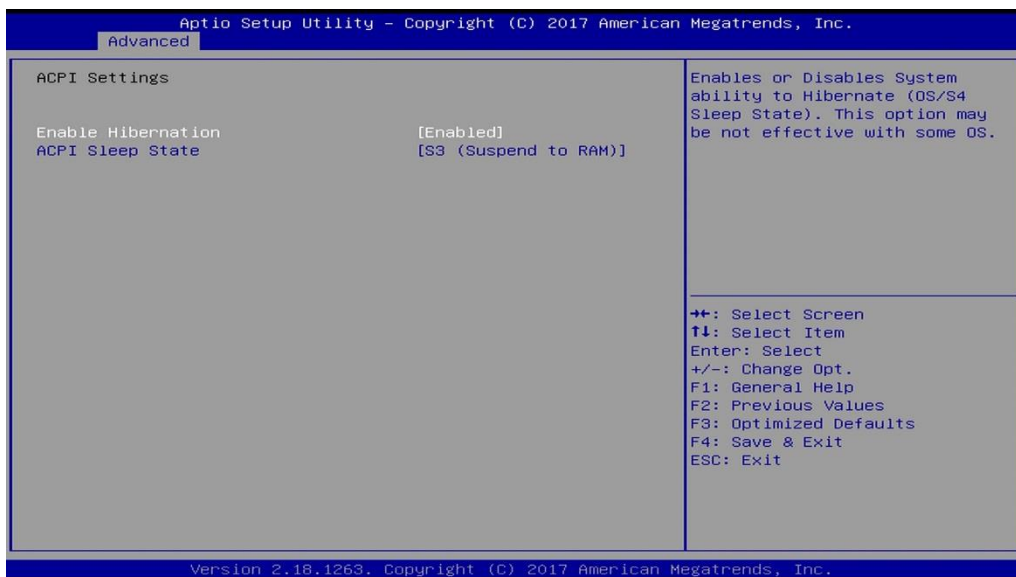

| BIOS Setting | Description |
|--------------------|--|
| Enable Hibernation | Enables / Disables the system ability to hibernate (OS/S4 Sleep State). This option may not be effective with some OS. |
| ACPI Sleep State | Selects a ACPI sleep state for the system to enter. Options: Suspend Disabled, S3 (Suspend to RAM) |

4.4.2 LFP (eDP) to LVDS Configuration

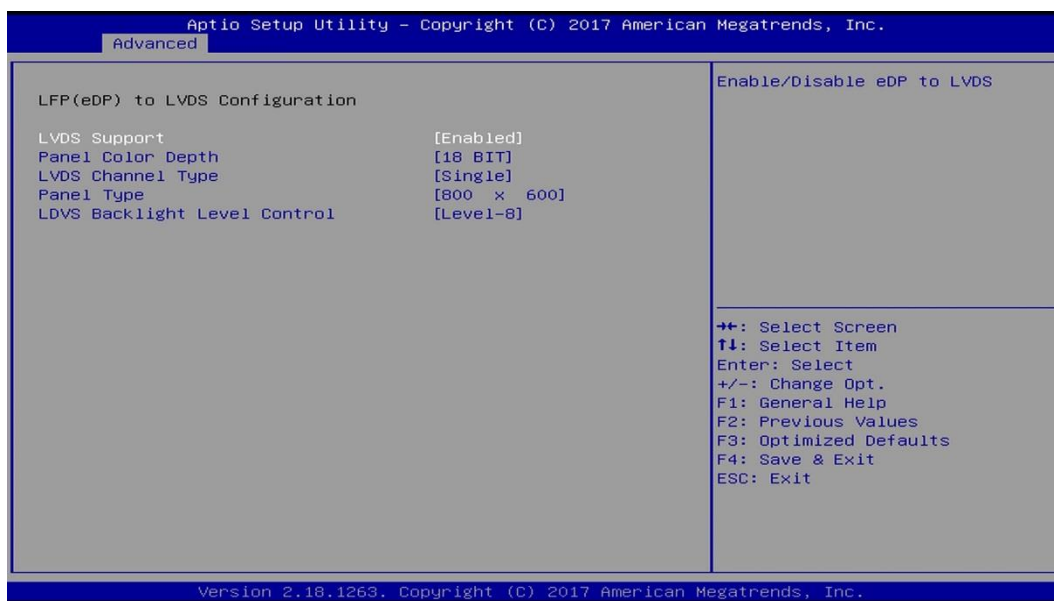

| BIOS Setting | Description |
|------------------------------|--|
| LVDS Support | Enables / Disables eDP to LVDS. |
| Panel Color Depth | Selects a panel color depth as 18 or 24 (VESA or JEIDA) bit. |
| LVDS Channel Type | Sets the LVDS channel type as single or dual channel. |
| Panel Type | Selects a resolution that fits your panel. Options: 800 x 600 / 1024 x 768 / 1280 x 1024 / 1366 x 768 / 1440 x 900 / 1600 x 900 / 1920 x 1080 |
| LVDS Backlight Level Control | Selects from Level 1 to Level 8 for the LVDS backlight. |

4.4.3 EFP (DP) to LVDS Configuration



| BIOS Setting | Description |
|------------------------------|--|
| LVDS Support | Enables / Disables DP to LVDS. |
| Panel Color Depth | Selects a panel color depth as 18 or 24 (VESA or JEIDA) bit. |
| LVDS Channel Type | Sets the LVDS channel type as single or dual channel. |
| Panel Type | Selects a resolution that fits your panel. Options: 800 x 600 / 1024 x 768 / 1280 x 1024 / 1366 x 768 / 1440 x 900 / 1600 x 900 / 1920 x 1080 |
| LVDS Backlight Level Control | Selects from Level 1 to Level 8 for the LVDS backlight. |

4.4.4 Fintek Super IO Configuration

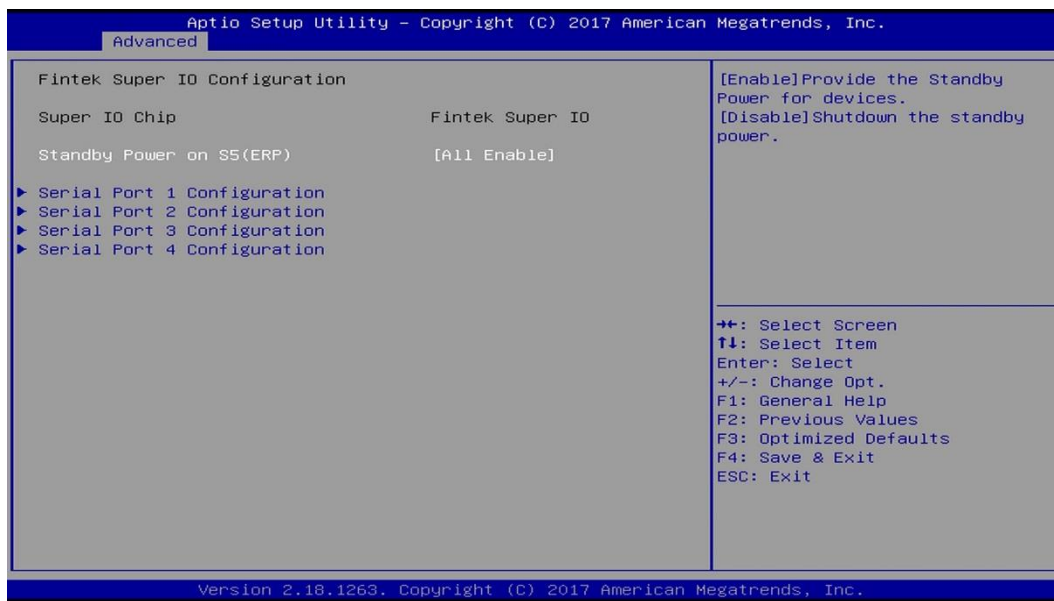

| BIOS Setting | Description |
|----------------------------|--|
| Standby Power on S5 (ERP) | Enable the item to provide the standby power for devices. Disable the item to shut down the standby power. Options: All Enable / Enable Ethernet for WOL / All Disable |
| Serial Ports Configuration | Sets parameters of serial ports. Enables / Disables the serial port and select an optimal setting for the Super IO device. |

4.4.4.1. Serial Port 1 Configuration

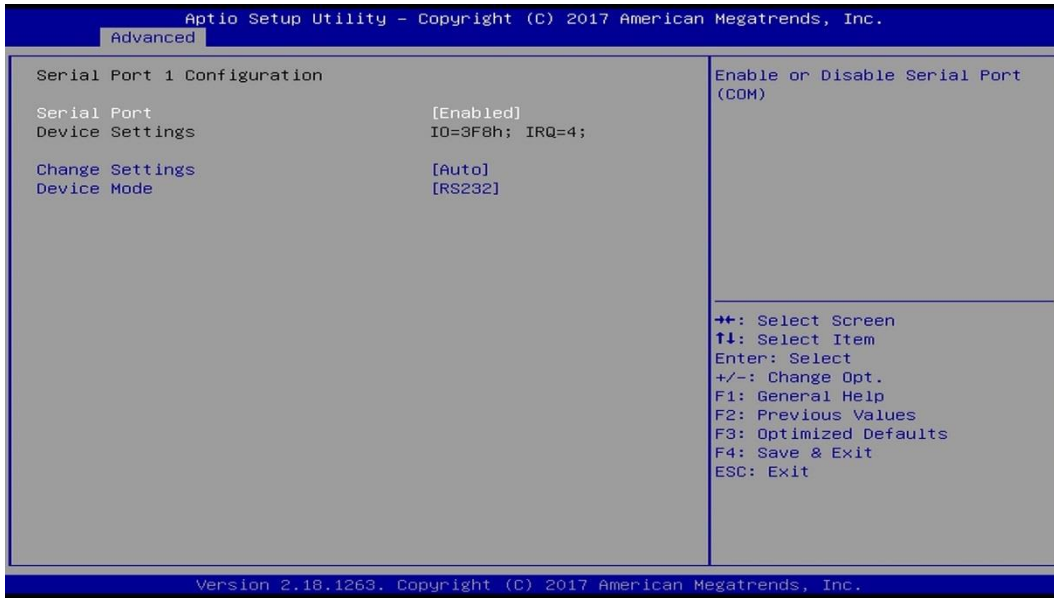

| BIOS Setting | Description |
|-----------------|--|
| Serial Port | Enables / Disables the serial port. |
| Change Settings | Selects an optimal settings for Super IO device. |
| Device Mode | Changes the serial port mode to: <ul style="list-style-type: none"> • RS232 • RS485 TX Low Active • RS485 with Termination TX Low Active • RS422 • RS422 with Termination |

4.4.5 Fintek Super I/O Hardware Monitor

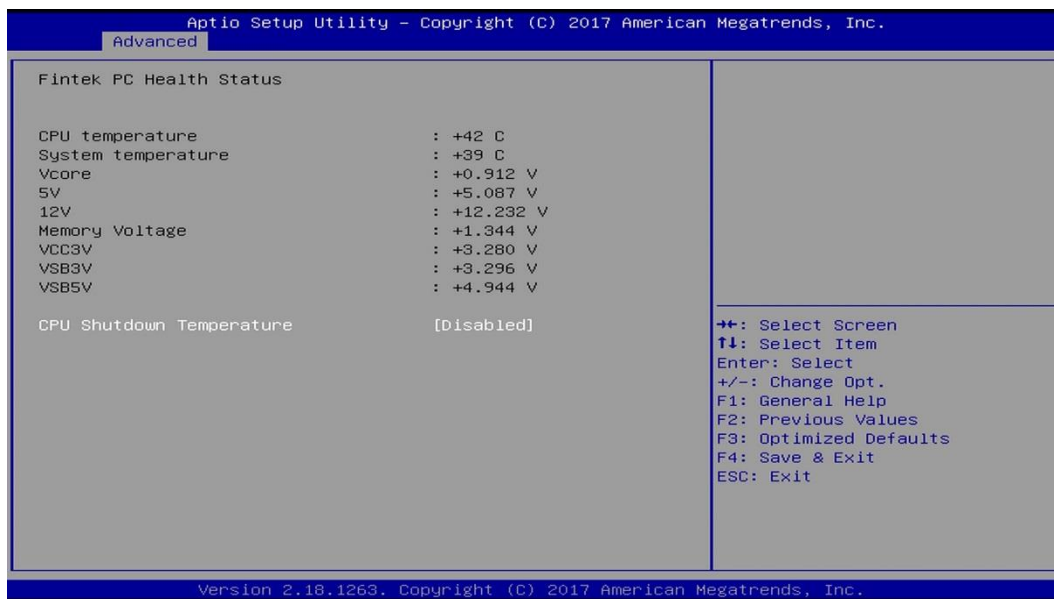

| BIOS Setting | Description |
|--------------------------|---|
| Temperatures / Voltages | These fields are the parameters of the hardware monitoring function feature of the motherboard. The values are read-only values as monitored by the system and show the PC health status. |
| CPU Shutdown Temperature | Sets a threshold of temperature to shut down if CPU goes overheated. Options: Disabled / 70°C / 75°C / 80°C / 85°C / 90°C / 95°C |

4.4.6 CPU Configuration

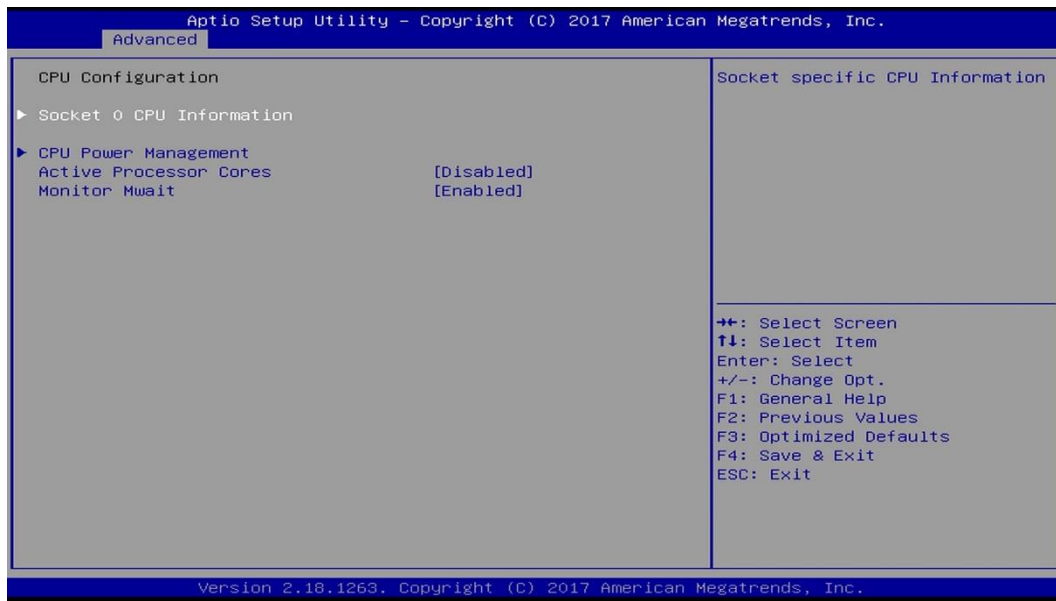

| BIOS Setting | Description |
|--------------------------|--|
| Socket 0 CPU Information | Displays the socket specific CPU information. |
| CPU Power Management | Allows you to enable / disable Turbo Mode. |
| Active Processor Cores | Enables / Disables the cores in the processor package. |
| Monitor Mwait | Enables / Disables Monitor Mwait. |

4.4.6.1. Socket 0 CPU Information

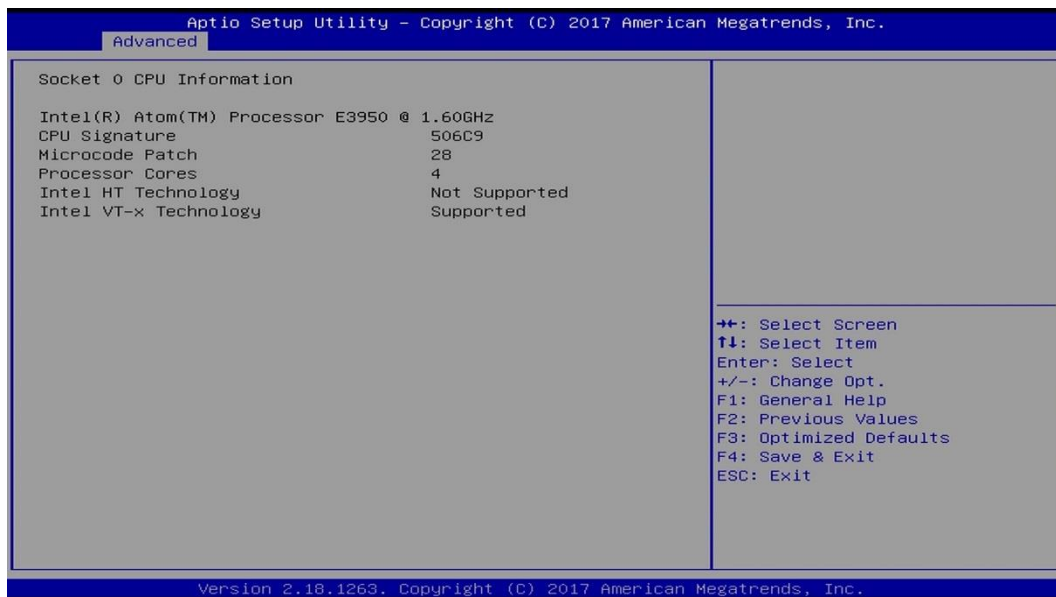

4.4.6.2. CPU Power Management Configuration

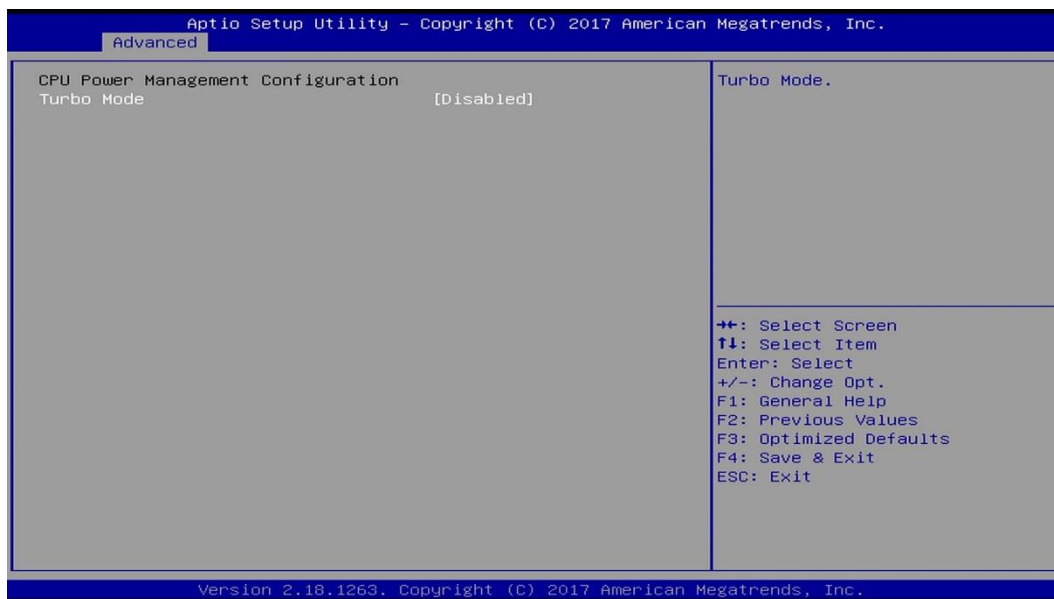

| BIOS Setting | Description |
|--------------|------------------------------------|
| Turbo Mode | Enables / Disables the turbo mode. |

4.4.7 AMI Graphic Output Protocol Policy

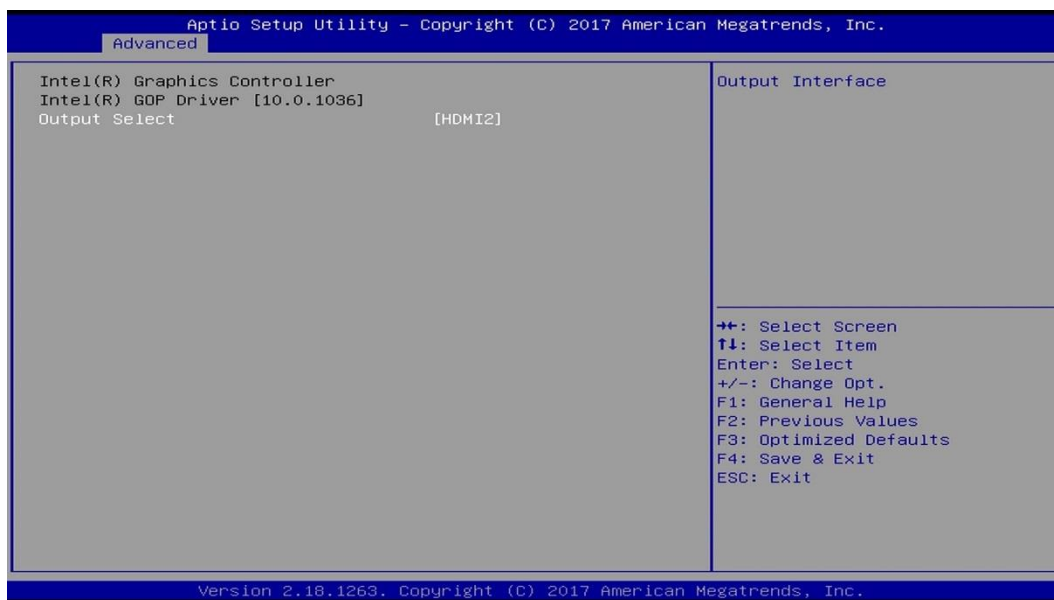

| BIOS Setting | Description |
|---------------|---------------------------------|
| Output Select | Outputs through HDMI interface. |

4.4.8 Network Stack Configuration

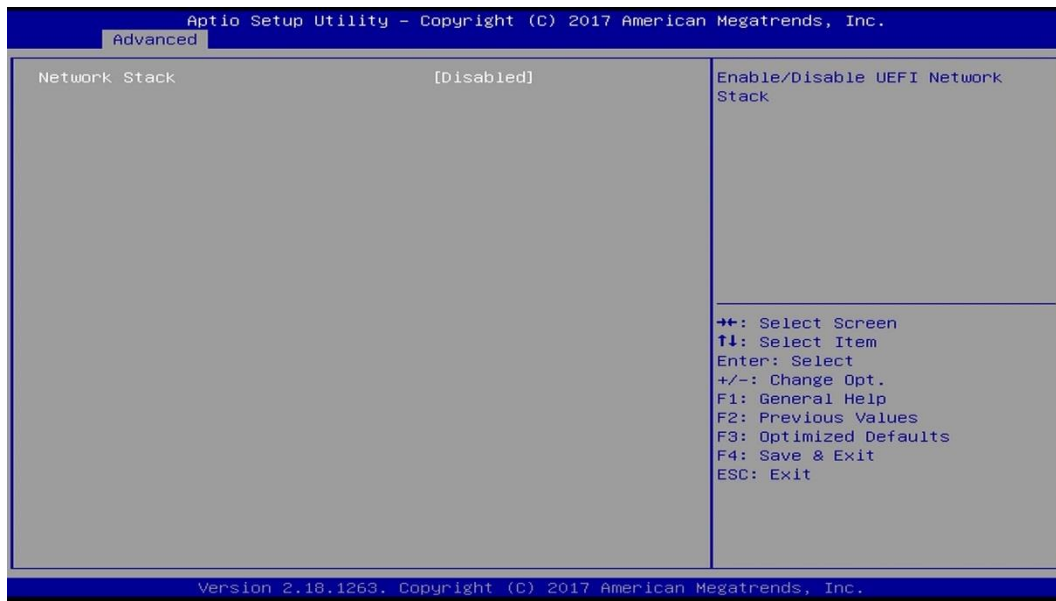

| BIOS Setting | Description |
|--------------------|--|
| Network Stack | Enables / Disables UEFI Network Stack. |
| IPv4 PXE Support | Enables / Disables IPv4 PXE Boot Support. If disabled, Ipv4 PXE boot option will not be created. |
| IPv4 HTTP Support | Enables / Disables IPv4 HTTP Boot Support. If disabled, Ipv4 HTTP boot option will not be created. |
| IPv6 PXE Support | Enables / Disables IPv6 PXE Boot Support. If disabled, Ipv4 PXE boot option will not be created. |
| IPv6 HTTP Support | Enables / Disables IPv6 HTTP Boot Support. If disabled, Ipv4 HTTP boot option will not be created. |
| PXE boot wait time | Assigns a period of time to press ESC key to abort the PXE boot. |
| Media detect count | Assigns a number of times to check the presence of media. |

4.4.9 CSM Configuration



| BIOS Setting | Description |
|---------------------|--|
| CSM Support | Enables / Disables CSM support. |
| GateA20 Active | <ul style="list-style-type: none"> Upon Request disables GA20 when using BIOS services. Always cannot disable GA20, but is useful when any RT code is executed above 1 MB. |
| INT19 Trap Response | Sets how BIOS reacts on INT19 trap by Option ROM. <ul style="list-style-type: none"> Immediate executes the trap right away. Postponed executes the trap during legacy boot. |
| Boot option filter | Controls the priority of Legacy and UEFI ROMs. |
| Network | Controls the execution of UEFI and Legacy PXE OpROM. |
| Storage | Controls the execution of UEFI and Legacy Storage OpROM. |
| Video | Controls the execution of UEFI and Legacy Video OpROM. |
| Other PCI devices | Determines OpROM execution policy for devices other than network, storage or video. |

4.4.10 USB Configuration

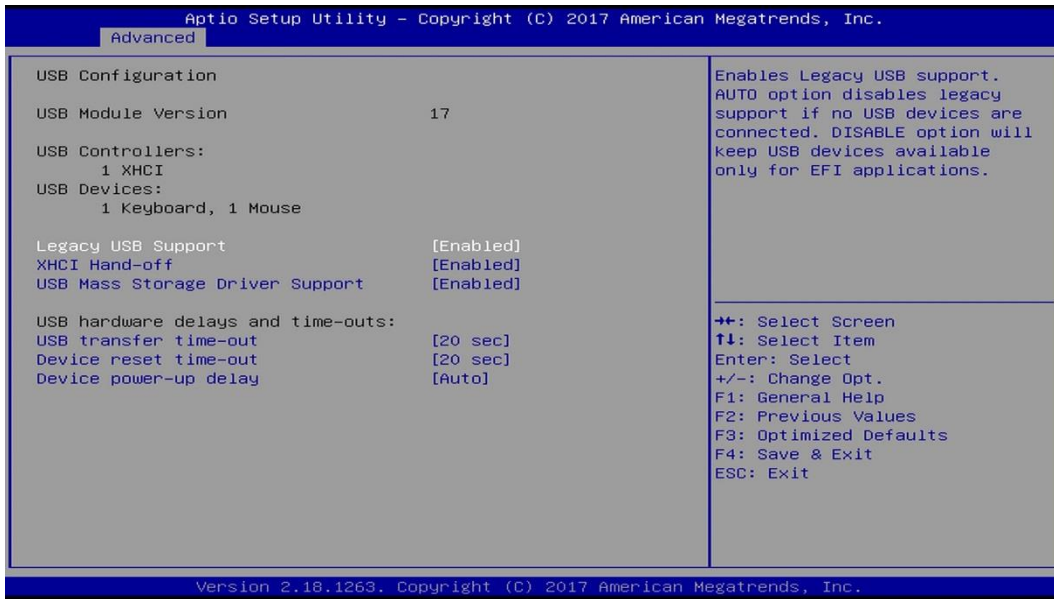

| BIOS Setting | Description |
|---------------------------------|---|
| Legacy USB Support | <ul style="list-style-type: none"> Enabled enables Legacy USB support. Auto disables legacy support if there is no USB device connected. Disabled keeps USB devices available only for EFI applications. |
| XHCI Hand-off | This is a workaround for OSeS without XHCI hand-off support. The XHCI ownership change should be claimed by XHCI driver. |
| USB Mass Storage Driver Support | Enables / Disables the support for USB mass storage driver. |
| USB Transfer time-out | The time-out value (1 / 5 10 / 20 secs) for Control, Bulk, and Interrupt transfers. |
| Device reset time-out | Gives seconds (10 / 20 / 30 / 40 secs) to delay execution of Start Unit command to USB mass storage device. |
| Device power-up delay | The maximum time the device will take before it properly reports itself to the Host Controller. Auto uses default value for a Root port it is 100ms. But for a Hub port, the delay is taken from Hub descriptor. |

4.5 Chipset Settings

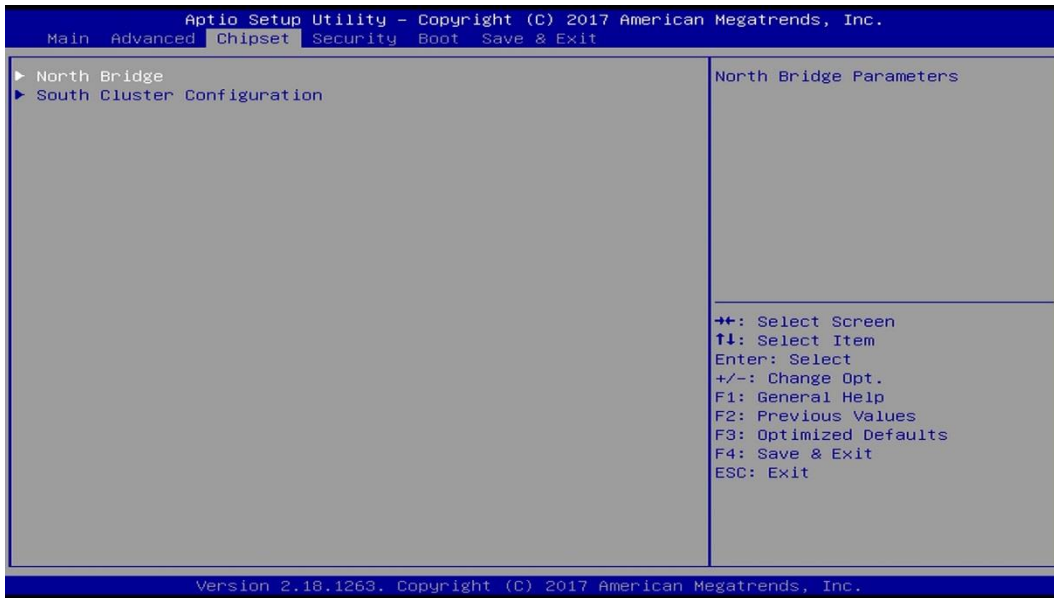

4.5.1 North Bridge

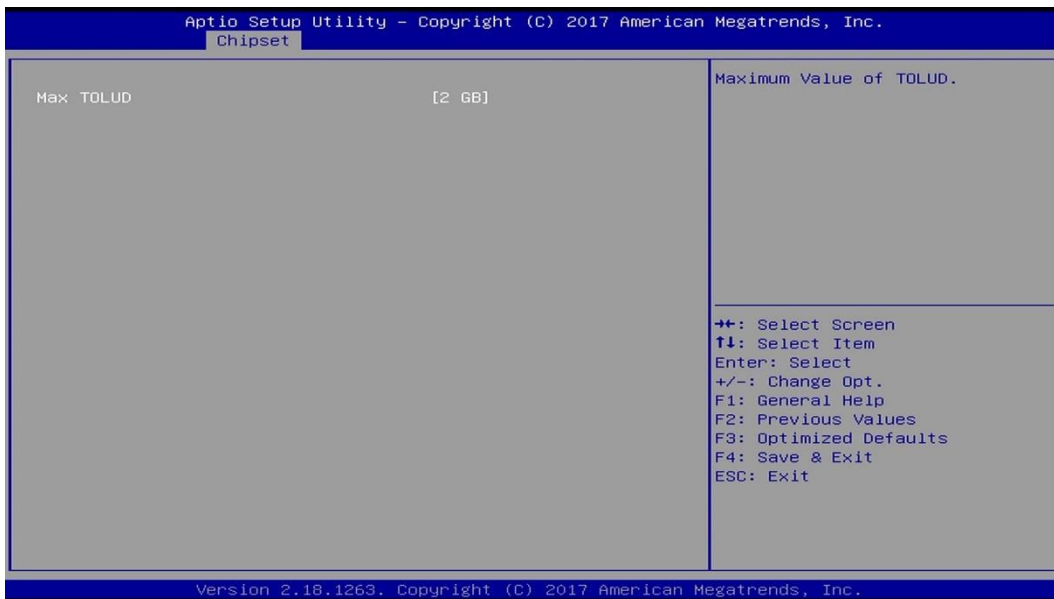

| BIOS Setting | Description |
|--------------|--------------------------------|
| Max TOLUD | Sets a maximum value of TOLUD. |

4.5.2 South Cluster Configuration

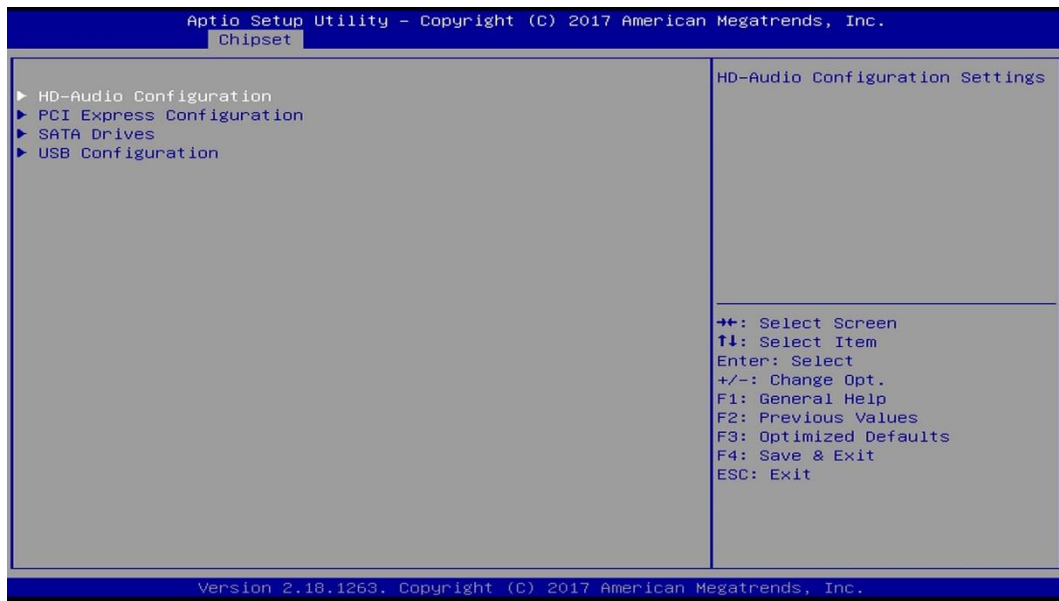

4.5.2.1. HD Audio Configuration

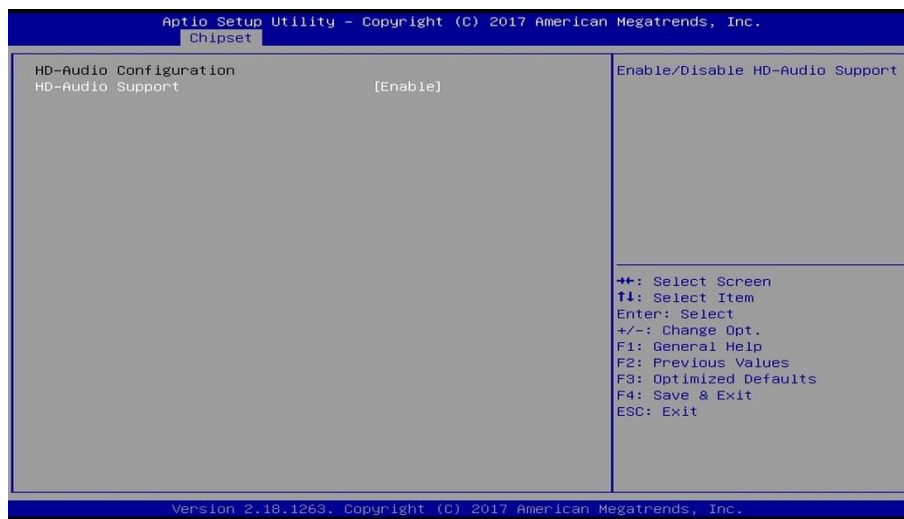

| BIOS Setting | Description |
|------------------|--------------------------------------|
| HD-Audio Support | Enables / Disables HD-Audio support. |

4.5.2.2. PCI Express Configuration

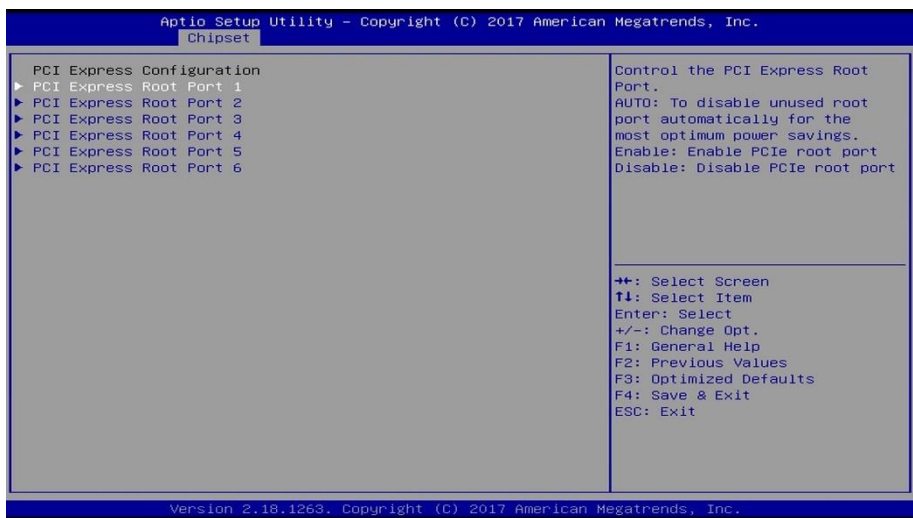

| BIOS Setting | Description |
|------------------------------|--|
| PCI Express Root Ports 1 ~ 6 | Accesses the control of the PCI Express Root Port. |

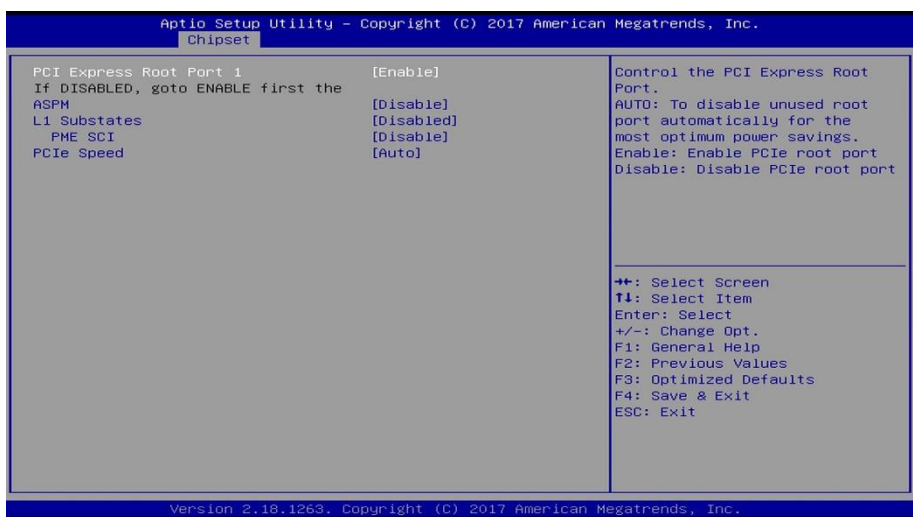

| BIOS Setting | Description |
|-----------------------|--|
| PCI Express Root Port | Enables/ Disables the PCIe root port. Auto allows you to disable unused root port automatically for the most optimum power savings. |
| ASPM | Sets the PCIe active state power management. Options: Disable / L0s / L1 / L0SL1 / Auto |
| L1 Substates | Sets PCIe L1 substates. Options: Disables / L1.1 / L1.2 / L1.1 & L1.2 |
| PME SCI | Enables / Disables PME SCI. |
| PCIe Speed | Configures the PCIe speed. Options: Auto, Gen1, Gen2 |

4.5.2.3. SATA Drivers

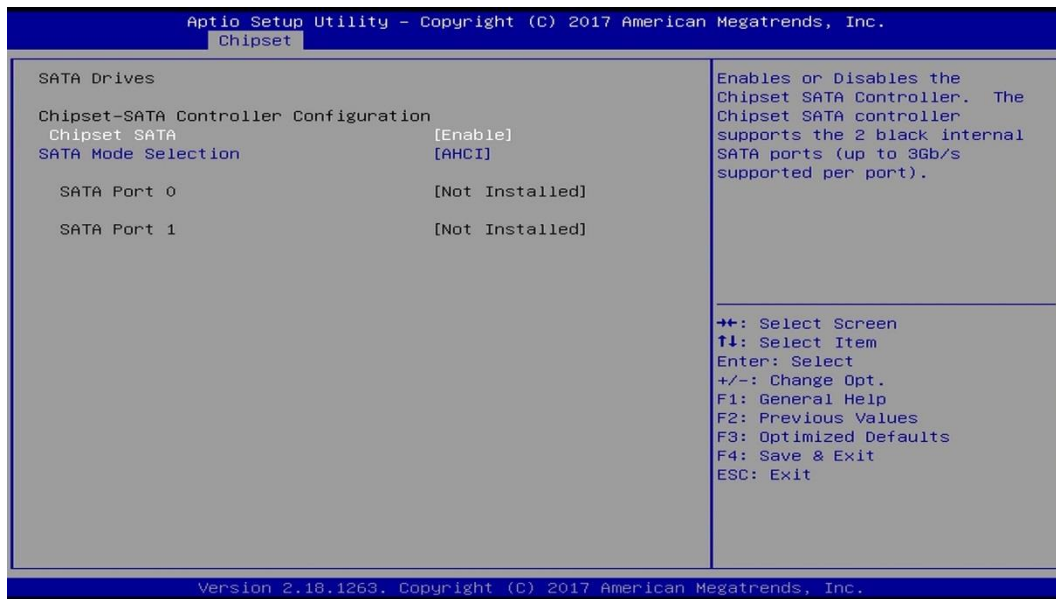

| BIOS Setting | Description |
|---------------------|---|
| Chipset SATA | Enables / Disables the Chipset SATA Controller. The Chipset SATA Controller supports the 2 black internal SATA ports (up to 3Gb/s supported per port). |
| SATA Mode Selection | Determines how SATA controller(s) operate. |

4.5.2.4. USB Configuration

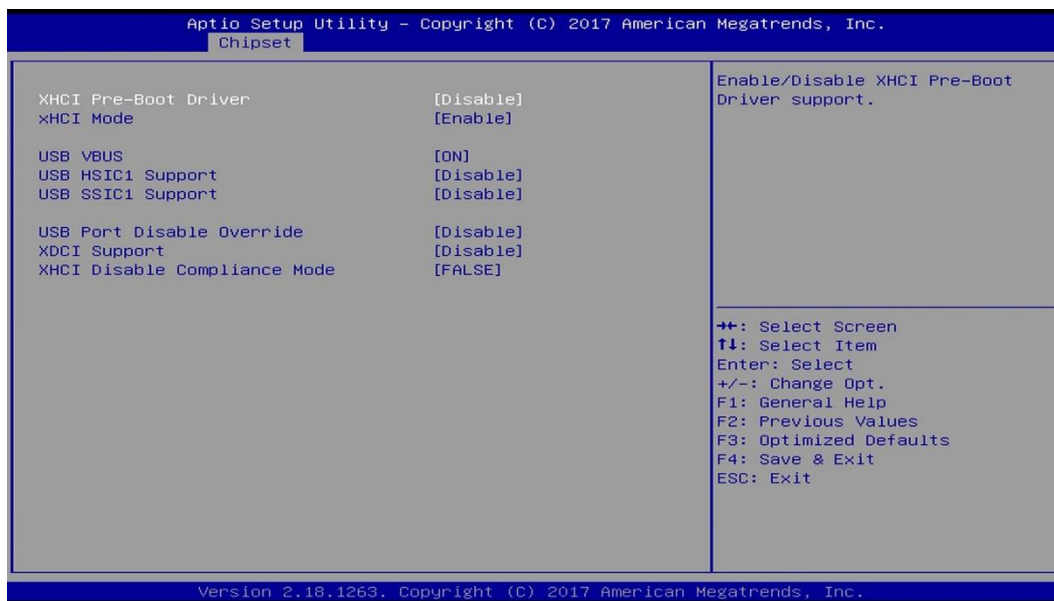

| BIOS Setting | Description |
|------------------------------|--|
| XHCI Pre-Boot Driver | Enables / Disables the support for XHCI Pre-Boot Driver. |
| XHCI Mode | Enables / Disables XHCI mode. If disabled, XHCI controller would be disabled, and none of the USB devices are detectable or usable when system is booted up in OS. Do NOT disable it unless for debug purpose. |
| USB VBUS | VBUS should be ON in HOST mode. It should be OFF in OTG device mode. |
| USB HSIC1 Support | Enables / Disables USB HSIC1. |
| USB SSIC1 Support | Enables / Disables USB SSIC1. |
| USB Port Disable Override | Selectively enables / disables the corresponding USB port from reporting a device connection to the controller. |
| XDCI Support | Enables / Disables XDCI. |
| XHCI Disable Compliance Mode | FALSE makes the XHCI Link Compliance Mode not disabled. TRUE disables the XHCI Link Compliance Mode. |

4.6 Security Settings

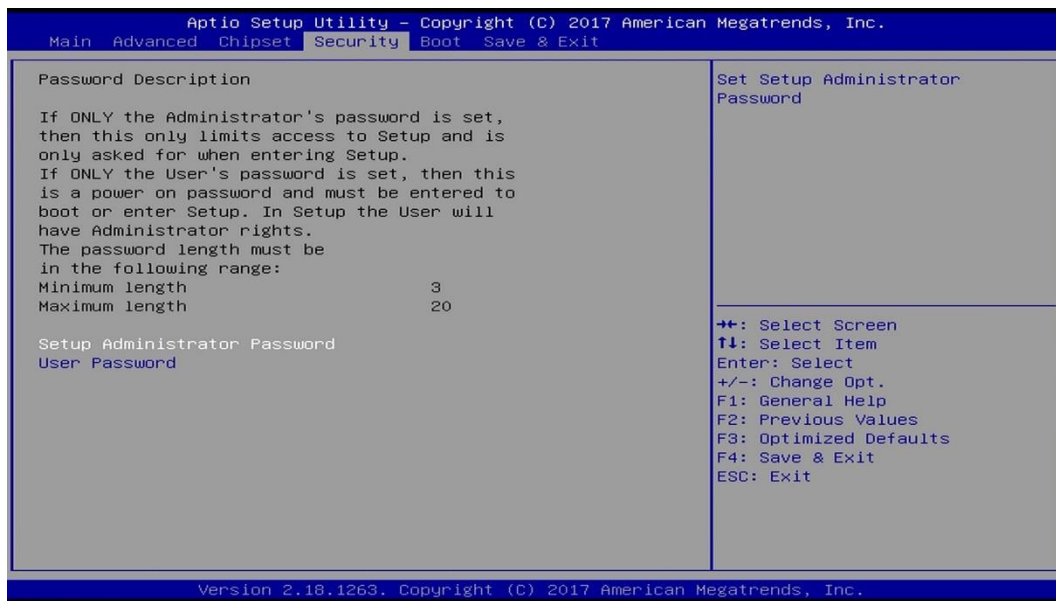

| BIOS Setting | Description |
|------------------------------|---|
| Setup Administrator Password | Sets an administrator password for the setup utility. |
| User Password | Sets a user password. |

4.7 Boot Settings

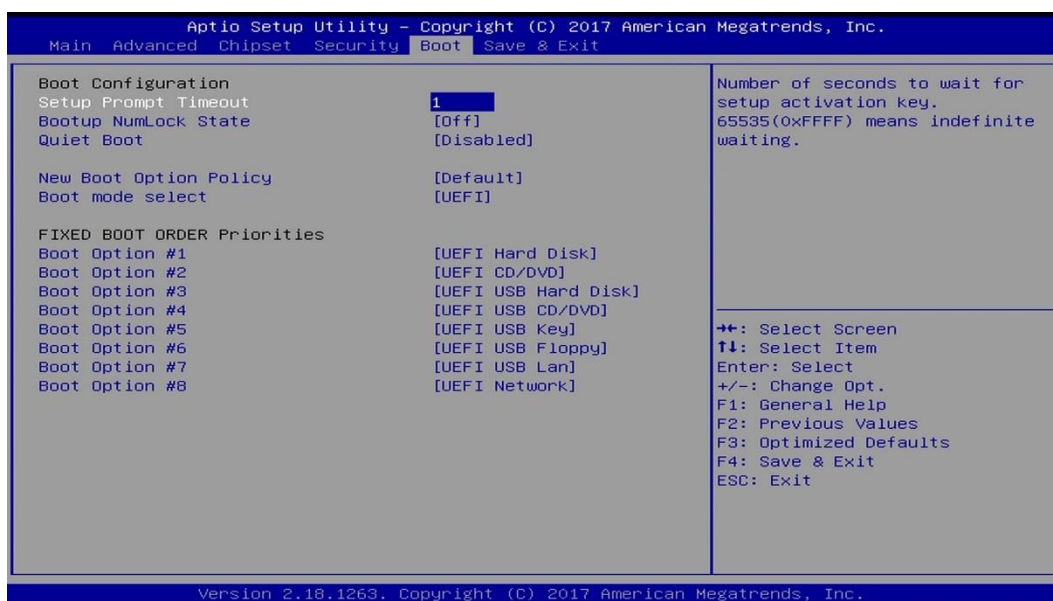

| BIOS Setting | Description |
|------------------------|--|
| Setup Prompt Timeout | Number of seconds to wait for setup activation key. 65535 (0xFFFF) means indefinite waiting. |
| Bootup NumLock State | Selects the keyboard NumLock state. |
| Quiet Boot | Enables / Disables Quiet Boot option. |
| New Boot Option Policy | Controls the placement of newly detected UEFI boot options. Options: Default, Place First, Place Last |
| Boot mode select | Selects a Boot mode, Legacy / UEFI / Dual. |
| Boot Option Priorities | Sets the system boot order priorities for hard disk, CD/DVD, USB, Network. |

4.8 Save & Exit Settings

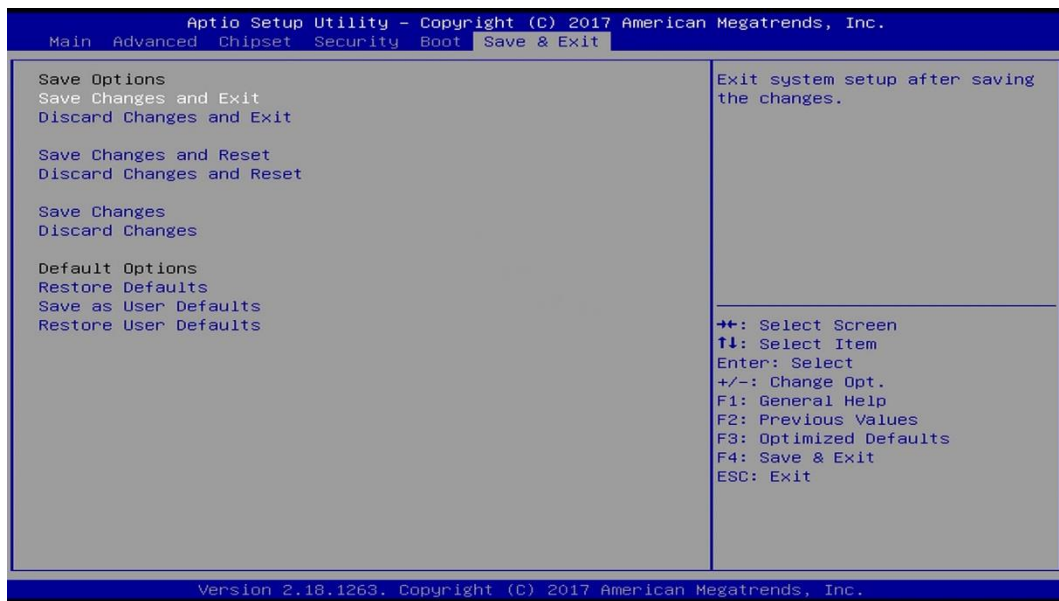

| BIOS Setting | Description |
|---------------------------|---|
| Save Changes and Exit | Exits system setup after saving the changes. |
| Discard Changes and Exit | Exits system setup without saving any changes. |
| Save Changes and Reset | Resets the system after saving the changes. |
| Discard Changes and Reset | Resets system setup without saving any changes. |
| Save Changes | Saves changes done so far to any of the setup options. |
| Discard Changes | Discards changes done so far to any of the setup options. |
| Restore Defaults | Restores / Loads defaults values for all the setup options. |
| Save as User Defaults | Saves the changes done so far as User Defaults. |
| Restore User Defaults | Restores the user defaults to all the setup options. |

Appendix

This section provides the mapping addresses of peripheral devices and the sample code of watchdog timer configuration.

- I/O Port Address Map
- Interrupt Request Lines (IRQ)
- Watchdog Timer Configuration

A. I/O Port Address Map

Each peripheral device in the system is assigned a set of I/O port addresses which also becomes the identity of the device. The following table lists the I/O port addresses used.

| Address | Device Description |
|-----------------------|---|
| 0x00000A00-0x00000A0F | Motherboard resources |
| 0x00000A10-0x00000A1F | Motherboard resources |
| 0x00000A20-0x00000A2F | Motherboard resources |
| 0x0000002E-0x0000002F | Motherboard resources |
| 0x0000004E-0x0000004F | Motherboard resources |
| 0x00000061-0x00000061 | Motherboard resources |
| 0x00000063-0x00000063 | Motherboard resources |
| 0x00000065-0x00000065 | Motherboard resources |
| 0x00000067-0x00000067 | Motherboard resources |
| 0x00000070-0x00000070 | Motherboard resources |
| 0x00000070-0x00000070 | System CMOS/real time clock |
| 0x00000080-0x0000008F | Motherboard resources |
| 0x00000092-0x00000092 | Motherboard resources |
| 0x000000B2-0x000000B3 | Motherboard resources |
| 0x00000680-0x0000069F | Motherboard resources |
| 0x00000400-0x0000047F | Motherboard resources |
| 0x00000500-0x000005FE | Motherboard resources |
| 0x00000600-0x0000061F | Motherboard resources |
| 0x0000164E-0x0000164F | Motherboard resources |
| 0x0000F040-0x0000F05F | Intel(R) Celeron(R)/Pentium(R) Processor SMBUS - 5AD4 |
| 0x0000D000-0x0000DFFF | Intel(R) Celeron(R)/Pentium(R) Processor PCI Express Root Port - 5AD9 |
| 0x000003F8-0x000003FF | Communications Port (COM1) |
| 0x000002F8-0x000002FF | Communications Port (COM2) |
| 0x000003E8-0x000003EF | Communications Port (COM3) |
| 0x000002E8-0x000002EF | Communications Port (COM4) |

| Address | Device Description |
|-----------------------|--|
| 0x0000E000-0x0000EFFF | Intel(R) Celeron(R)/Pentium(R) Processor PCI Express Root Port - 5AD8 |
| 0x00000000-0x0000006F | PCI Express Root Complex |
| 0x00000078-0x00000CF7 | PCI Express Root Complex |
| 0x00000D00-0x0000FFFF | PCI Express Root Complex |
| 0x00000020-0x00000021 | Programmable interrupt controller |
| 0x00000024-0x00000025 | Programmable interrupt controller |
| 0x00000028-0x00000029 | Programmable interrupt controller |
| 0x0000002C-0x0000002D | Programmable interrupt controller |
| 0x00000030-0x00000031 | Programmable interrupt controller |
| 0x00000034-0x00000035 | Programmable interrupt controller |
| 0x00000038-0x00000039 | Programmable interrupt controller |
| 0x0000003C-0x0000003D | Programmable interrupt controller |
| 0x000000A0-0x000000A1 | Programmable interrupt controller |
| 0x000000A4-0x000000A5 | Programmable interrupt controller |
| 0x000000A8-0x000000A9 | Programmable interrupt controller |
| 0x000000AC-0x000000AD | Programmable interrupt controller |
| 0x000000B0-0x000000B1 | Programmable interrupt controller |
| 0x000000B4-0x000000B5 | Programmable interrupt controller |
| 0x000000B8-0x000000B9 | Programmable interrupt controller |
| 0x000000BC-0x000000BD | Programmable interrupt controller |
| 0x000004D0-0x000004D1 | Programmable interrupt controller |
| 0x0000F000-0x0000F03F | Intel(R) HD Graphics |
| 0x0000F090-0x0000F097 | Standard SATA AHCI Controller |
| 0x0000F080-0x0000F083 | Standard SATA AHCI Controller |
| 0x0000F060-0x0000F07F | Standard SATA AHCI Controller |
| 0x00000040-0x00000043 | System timer |
| 0x00000050-0x00000053 | System timer |

B. Interrupt Request Lines (IRQ)

Peripheral devices use interrupt request lines to notify CPU for the service required. The following table shows the IRQ used by the devices on board.

| Level | Function |
|------------------------------------|--|
| IRQ 25 | High Definition Audio Controller |
| IRQ 4294967280 ~ IRQ 4294967285 | Intel(R) I210 Gigabit Network Connection |
| IRQ 8 | High precision event timer |
| IRQ 4 | Communications Port (COM1) |
| IRQ 3 | Communications Port (COM2) |
| IRQ 5 | Communications Port (COM3) |
| IRQ 10 | Communications Port (COM4) |
| IRQ 4294967279 | Intel(R) USB 3.0 eXtensible Host Controller - 1.0 (Microsoft) |
| IRQ 54 ~ IRQ 511 | Microsoft ACPI-Compliant System |
| IRQ 4294967292 | Intel(R) Trusted Execution Engine Interface |
| IRQ 4294967293 | Intel(R) HD Graphics |
| IRQ 14 | Intel(R) Serial IO GPIO Host Controller - INT3452 |
| IRQ 4294967294 | Standard SATA AHCI Controller |
| IRQ 4294967286 ~ IRQ 4294967291 | Intel(R) I210 Gigabit Network Connection #2 |
| IRQ 0 | System timer |

C. Watchdog Timer Configuration

The Watchdog Timer (WDT) is used to generate a variety of output signals after a user programmable count. The WDT is suitable for the use in the prevention of system lock-up, such as when software becomes trapped in a deadlock. Under these sorts of circumstances, the timer will count to zero and the selected outputs will be driven.

Under normal circumstance, you will need to restart the WDT at regular intervals before the timer counts to zero.

Sample Code

```
//-----
//
// THIS CODE AND INFORMATION IS PROVIDED "AS IS" WITHOUT WARRANTY OF ANY
// KIND, EITHER EXPRESSED OR IMPLIED, INCLUDING BUT NOT LIMITED TO THE
// IMPLIED WARRANTIES OF MERCHANTABILITY AND/OR FITNESS FOR A
// PARTICULAR
// PURPOSE.
//
//-----
#include <dos.h>
#include <conio.h>
#include <stdio.h>
#include <stdlib.h>
#include "F81964.H"
//-----
int main (int argc, char *argv[]);
void EnableWDT(int);
void DisableWDT(void);
//-----
int main (int argc, char *argv[])
{
    unsigned char bBuf;
    unsigned char bTime;
    char **endptr;

    char SIO;

    printf("Fintek 81964 watch dog program\n");
    SIO = Init_F81964();
    if (SIO == 0)
    {
        printf("Can not detect Fintek 81964, program abort.\n");
        return(1);
    }//if (SIO == 0)

    if (argc != 2)
    {
        printf(" Parameter incorrect!!\n");
        return (1);
    }
}
```

```
bTime = strtol(argv[1], endptr, 10);
printf("System will reset after %d seconds\n", bTime);

if (bTime)
{   EnableWDT(bTime); }
else
{   DisableWDT(); }
return 0;
}
//-----
void EnableWDT(int interval)
{
unsigned char bBuf;

bBuf = Get_F81964_Reg(0x2B);
bBuf &= (~0x20);
Set_F81964_Reg(0x2B, bBuf);    //Enable WDTO

Set_F81964_LD(0x07);          //switch to logic device 7
Set_F81964_Reg(0x30, 0x01);  //enable timer

bBuf = Get_F81964_Reg(0xF5);
bBuf &= (~0x0F);
bBuf |= 0x52;
Set_F81964_Reg(0xF5, bBuf);  //count mode is second

Set_F81964_Reg(0xF6, interval); //set timer

bBuf = Get_F81964_Reg(0xFA);
bBuf |= 0x01;
Set_F81964_Reg(0xFA, bBuf);  //enable WDTO output

bBuf = Get_F81964_Reg(0xF5);
bBuf |= 0x20;
Set_F81964_Reg(0xF5, bBuf);  //start counting
}
//-----
void DisableWDT(void)
{
unsigned char bBuf;

Set_F81964_LD(0x07);          //switch to logic device 7

bBuf = Get_F81964_Reg(0xFA);
bBuf &= ~0x01;
Set_F81964_Reg(0xFA, bBuf);  //disable WDTO output

bBuf = Get_F81964_Reg(0xF5);
bBuf &= ~0x20;
bBuf |= 0x40;
Set_F81964_Reg(0xF5, bBuf);  //disable WDT
}
//-----
```

```

//-----
//
// THIS CODE AND INFORMATION IS PROVIDED "AS IS" WITHOUT WARRANTY OF ANY
// KIND, EITHER EXPRESSED OR IMPLIED, INCLUDING BUT NOT LIMITED TO THE
// IMPLIED WARRANTIES OF MERCHANTABILITY AND/OR FITNESS FOR A
// PARTICULAR
// PURPOSE.
//
//-----
#include "F81964.H"
#include <dos.h>
//-----
unsigned int F81964_BASE;
void Unlock_F81964 (void);
void Lock_F81964 (void);
//-----
unsigned int Init_F81964(void)
{
    unsigned int result;
    unsigned char ucDid;

    F81964_BASE = 0x4E;
    result = F81964_BASE;

    ucDid = Get_F81964_Reg(0x20);
    if (ucDid == 0x07) //Fintek 81964
    { goto Init_Finish; }

    F81964_BASE = 0x2E;
    result = F81964_BASE;

    ucDid = Get_F81964_Reg(0x20);
    if (ucDid == 0x07) //Fintek 81964
    { goto Init_Finish; }

    F81964_BASE = 0x00;
    result = F81964_BASE;

    Init_Finish:
    return (result);
}
//-----
void Unlock_F81964 (void)
{
    outportb(F81964_INDEX_PORT, F81964_UNLOCK);
    outportb(F81964_INDEX_PORT, F81964_UNLOCK);
}
//-----
void Lock_F81964 (void)
{
    outportb(F81964_INDEX_PORT, F81964_LOCK);
}
//-----

```

iBASE

```
void Set_F81964_LD( unsigned char LD)
{
Unlock_F81964();
outportb(F81964_INDEX_PORT, F81964_REG_LD);
outportb(F81964_DATA_PORT, LD);
Lock_F81964();
}
//-----
void Set_F81964_Reg( unsigned char REG, unsigned char DATA)
{
Unlock_F81964();
outportb(F81964_INDEX_PORT, REG);
outportb(F81964_DATA_PORT, DATA);
Lock_F81964();
}
//-----
unsigned char Get_F81964_Reg(unsigned char REG)
{
unsigned char Result;
Unlock_F81964();
outportb(F81964_INDEX_PORT, REG);
Result = inportb(F81964_DATA_PORT);
Lock_F81964();
return Result;
}
//-----

//-----
//
// THIS CODE AND INFORMATION IS PROVIDED "AS IS" WITHOUT WARRANTY OF ANY
// KIND, EITHER EXPRESSED OR IMPLIED, INCLUDING BUT NOT LIMITED TO THE
// IMPLIED WARRANTIES OF MERCHANTABILITY AND/OR FITNESS FOR A
// PARTICULAR
// PURPOSE.
//
//-----
#ifndef F81964_H
#define F81964_H 1
//-----
#define F81964_INDEX_PORT (F81964_BASE)
#define F81964_DATA_PORT (F81964_BASE+1)
//-----
#define F81964_REG_LD 0x07
//-----
#define F81964_UNLOCK 0x87
#define F81964_LOCK 0xAA
//-----
unsigned int Init_F81964(void);
void Set_F81964_LD( unsigned char);
void Set_F81964_Reg( unsigned char,
unsigned char);
unsigned char
Get_F81964_Reg( unsigned char);
//-----
#endif // F81964_H
```

Our company network supports you worldwide with offices in Germany, Austria, Switzerland, the UK and the USA. For more information please contact:

Headquarters

Germany



FORTEC Elektronik AG

Augsburger Str. 2b
82110 Germering

Phone: +49 89 894450-0
E-Mail: info@fortecaq.de
Internet: www.fortecaq.de

Fortec Group Members

Austria



Distec GmbH Office Vienna

Nuschinggasse 12
1230 Wien

Phone: +43 1 8673492-0
E-Mail: info@distec.de
Internet: www.distec.de

Germany



Distec GmbH

Augsburger Str. 2b
82110 Germering

Phone: +49 89 894363-0
E-Mail: info@distec.de
Internet: www.distec.de

Switzerland



ALTRAC AG

Bahnhofstraße 3
5436 Würenlos

Phone: +41 44 7446111
E-Mail: info@altrac.ch
Internet: www.altrac.ch

United Kingdom



Display Technology Ltd.

Osprey House, 1 Osprey Court
Hichingbrooke Business Park
Huntingdon, Cambridgeshire, PE29 6FN

Phone: +44 1480 411600
E-Mail: info@displaytechnology.co.uk
Internet: www.displaytechnology.co.uk

USA



Apollo Display Technologies, Corp.

87 Raynor Avenue,
Unit 1 Ronkonkoma,
NY 11779

Phone: +1 631 5804360
E-Mail: info@apolloDisplays.com
Internet: www.apolloDisplays.com