



OUR GLOBAL
COMPETENCE
CENTRES

 APOLLO DISPLAY
TECHNOLOGIES



 DISTEC



 DISPLAY
TECHNOLOGY



Manual

NEXCOM

Neu-X101

Edge Computing System Powered by Intel® Apollo Lake J3455 Processor



The information contained in this document has been carefully researched and is, to the best of our knowledge, accurate. However, we assume no liability for any product failures or damages, immediate or consequential, resulting from the use of the information provided herein. Our products are not intended for use in systems in which failures of product could result in personal injury. All trademarks mentioned herein are property of their respective owners. All specifications are subject to change without notice.



NEXCOM International Co., Ltd.

Intelligent Platform & Services Business Unit

Edge Computing System

Neu-X101

User Manual

CONTENTS

Preface

Copyright	iv
Disclaimer	iv
Acknowledgements	iv
Regulatory Compliance Statements	iv
Declaration of Conformity	iv
RoHS Compliance	v
Warranty and RMA	vi
Safety Information	viii
Installation Recommendations	viii
Safety Precautions	ix
Technical Support and Assistance	x
Conventions Used in this Manual	x
Global Service Contact Information	xi
Package Contents	xiii
Ordering Information	xiv

Chapter 1: Product Introduction

Neu-X101	1
Overview	1
Key Features	1
Hardware Specifications	2
Physical Features	4
Front Panel	4
Rear Panel	4
Mechanical Dimensions	5

Chapter 2: Jumpers and Connectors

Before You Begin	5
Precautions	5
Jumper Settings	6
Locations of the Jumpers and Connectors for Neu-X101	7
Top View	7
Bottom View	8
Jumpers & DIP Switches	9
AT/ATX Mode Select	9
Clear CMOS	9
LVDS Panel Voltage Select	10
LVDS Enable Select	10
LVDS Resolution Select	11
Connector Pin Definitions	12
Internal Connectors	12
LVDS Inverter Connector	12
System Reset Header	12
Power LED Connector	13
COM1 Connector	13
DC Power Input	14
FAN Connector	14
Debug Port/LPC Bus Connector	15
COM Port Connector	15
USB2.0 Connector	16
BIOS update connector	16
SIM Card Connector	17



GPIO Connector.....	17
Audio MIC Line Out Connector	18
Speaker Connector	18
Battery Connector.....	19
LVDS Panel Connector.....	19
COMPORT Ring Connector	20
eDP Panel Connector	21
Mini-PCIe Connector.....	22
M.2 Connector (M-Key)	23
Block Diagram	24

Chapter 3: System Setup

Installing a SO-DIMM Memory Module & M.2 M Key SSD Module.....	22
Installing a Wi-Fi Module (Mini-PCIe Slot)	23

Chapter 4: BIOS Setup

About BIOS Setup.....	28
When to Configure the BIOS.....	28
Default Configuration	29
Entering Setup	29
Legends	29
BIOS Setup Utility.....	31
Main	31
Advanced.....	32
Chipset.....	41
Security	45
Boot.....	46
Save & Exit	47

PREFACE

Copyright

This publication, including all photographs, illustrations and software, is protected under international copyright laws, with all rights reserved. No part of this manual may be reproduced, copied, translated or transmitted in any form or by any means without the prior written consent from NEXCOM International Co., Ltd.

Disclaimer

The information in this document is subject to change without prior notice and does not represent commitment from NEXCOM International Co., Ltd. However, users may update their knowledge of any product in use by constantly checking its manual posted on our website: <http://www.nexcom.com>. NEXCOM shall not be liable for direct, indirect, special, incidental, or consequential damages arising out of the use of any product, nor for any infringements upon the rights of third parties, which may result from such use. Any implied warranties of merchantability or fitness for any particular purpose is also disclaimed.

Acknowledgements

Neu-X101 is a trademark of NEXCOM International Co., Ltd. All other product names mentioned herein are registered trademarks of their respective owners.

Regulatory Compliance Statements

This section provides the FCC compliance statement for Class A devices and describes how to keep the system CE compliant.

Declaration of Conformity

FCC

This equipment has been tested and verified to comply with the limits for a Class A digital device, pursuant to Part 15 of FCC Rules. These limits are designed to provide reasonable protection against harmful interference when the equipment is operated in a commercial environment. This equipment generates, uses, and can radiate radio frequency energy and, if not installed and used in accordance with the instructions, may cause harmful interference to radio communications. Operation of this equipment in a residential area (domestic environment) is likely to cause harmful interference, in which case the user will be required to correct the interference (take adequate measures) at their own expense.

CE

The product(s) described in this manual complies with all applicable European Union (CE) directives if it has a CE marking. For computer systems to remain CE compliant, only CE-compliant parts may be used. Maintaining CE compliance also requires proper cable and cabling techniques.

RoHS Compliance



NEXCOM RoHS Environmental Policy and Status Update

NEXCOM is a global citizen for building the digital infrastructure. We are committed to providing green products and services, which are compliant with European Union RoHS (Restriction on Use of Hazardous Substance in Electronic Equipment) directive 2011/65/EU, to be your trusted green partner and to protect our environment.

RoHS restricts the use of Lead (Pb) < 0.1% or 1,000ppm, Mercury (Hg) < 0.1% or 1,000ppm, Cadmium (Cd) < 0.01% or 100ppm, Hexavalent Chromium (Cr6+) < 0.1% or 1,000ppm, Polybrominated biphenyls (PBB) < 0.1% or 1,000ppm, and Polybrominated diphenyl Ethers (PBDE) < 0.1% or 1,000ppm.

In order to meet the RoHS compliant directives, NEXCOM has established an engineering and manufacturing task force to implement the introduction of green products. The task force will ensure that we follow the standard NEXCOM development procedure and that all the new RoHS components and new manufacturing processes maintain the highest industry quality levels for which NEXCOM are renowned.

The model selection criteria will be based on market demand. Vendors and suppliers will ensure that all designed components will be RoHS compliant.

How to recognize NEXCOM RoHS Products?

For existing products where there are non-RoHS and RoHS versions, the suffix "(LF)" will be added to the compliant product name.

All new product models launched after January 2013 will be RoHS compliant. They will use the usual NEXCOM naming convention.

Warranty and RMA

NEXCOM Warranty Period

NEXCOM manufactures products that are new or equivalent to new in accordance with industry standard. NEXCOM warrants that products will be free from defect in material and workmanship for 2 years, beginning on the date of invoice by NEXCOM.

NEXCOM Return Merchandise Authorization (RMA)

- Customers shall enclose the “NEXCOM RMA Service Form” with the returned packages.
- Customers must collect all the information about the problems encountered and note anything abnormal or, print out any on-screen messages, and describe the problems on the “NEXCOM RMA Service Form” for the RMA number apply process.
- Customers can send back the faulty products with or without accessories (manuals, cable, etc.) and any components from the card, such as CPU and RAM. If the components were suspected as part of the problems, please note clearly which components are included. Otherwise, NEXCOM is not responsible for the devices/parts.
- Customers are responsible for the safe packaging of defective products, making sure it is durable enough to be resistant against further damage and deterioration during transportation. In case of damages occurred during transportation, the repair is treated as “Out of Warranty.”
- Any products returned by NEXCOM to other locations besides the customers’ site will bear an extra charge and will be billed to the customer.

Repair Service Charges for Out-of-Warranty Products

NEXCOM will charge for out-of-warranty products in two categories, one is basic diagnostic fee and another is component (product) fee.

System Level

- Component fee: NEXCOM will only charge for main components such as SMD chip, BGA chip, etc. Passive components will be repaired for free, ex: resistor, capacitor.
- Items will be replaced with NEXCOM products if the original one cannot be repaired. Ex: motherboard, power supply, etc.
- Replace with 3rd party products if needed.
- If RMA goods can not be repaired, NEXCOM will return it to the customer without any charge.

Board Level

- Component fee: NEXCOM will only charge for main components, such as SMD chip, BGA chip, etc. Passive components will be repaired for free, ex: resistors, capacitors.
- If RMA goods can not be repaired, NEXCOM will return it to the customer without any charge.

Warnings

Read and adhere to all warnings, cautions, and notices in this guide and the documentation supplied with the chassis, power supply, and accessory modules. If the instructions for the chassis and power supply are inconsistent with these instructions or the instructions for accessory modules, contact the supplier to find out how you can ensure that your computer meets safety and regulatory requirements.

Cautions

Electrostatic discharge (ESD) can damage system components. Do the described procedures only at an ESD workstation. If no such station is available, you can provide some ESD protection by wearing an antistatic wrist strap and attaching it to a metal part of the computer chassis.

Safety Information

Before installing and using the device, note the following precautions:

- Read all instructions carefully.
- Do not place the unit on an unstable surface, cart, or stand.
- Follow all warnings and cautions in this manual.
- When replacing parts, ensure that your service technician uses parts specified by the manufacturer.
- Avoid using the system near water, in direct sunlight, or near a heating device.
- The load of the system unit does not solely rely for support from the rackmounts located on the sides. Firm support from the bottom is highly necessary in order to provide balance stability.
- The computer is provided with a battery-powered real-time clock circuit. There is a danger of explosion if battery is incorrectly replaced. Replace only with the same or equivalent type recommended by the manufacturer. Discard used batteries according to the manufacturer's instructions.

Installation Recommendations

Ensure you have a stable, clean working environment. Dust and dirt can get into components and cause a malfunction. Use containers to keep small components separated.

Adequate lighting and proper tools can prevent you from accidentally damaging the internal components. Most of the procedures that follow require only a few simple tools, including the following:

- A Philips screwdriver
- A flat-tipped screwdriver
- A grounding strap
- An anti-static pad

Using your fingers can disconnect most of the connections. It is recommended that you do not use needle-nose pliers to disconnect connections as these can damage the soft metal or plastic parts of the connectors.

Safety Precautions

1. Read these safety instructions carefully.
2. Keep this User Manual for later reference.
3. Disconnect this equipment from any AC outlet before cleaning. Use a damp cloth. Do not use liquid or spray detergents for cleaning.
4. For plug-in equipment, the power outlet socket must be located near the equipment and must be easily accessible.
5. Keep this equipment away from humidity.
6. Put this equipment on a stable surface during installation. Dropping it or letting it fall may cause damage.
7. The openings on the enclosure are for air convection to protect the equipment from overheating. DO NOT COVER THE OPENINGS.
8. Make sure the voltage of the power source is correct before connecting the equipment to the power outlet.
9. Place the power cord in a way so that people will not step on it. Do not place anything on top of the power cord. Use a power cord that has been approved for use with the product and that it matches the voltage and current marked on the product's electrical range label. The voltage and current rating of the cord must be greater than the voltage and current rating marked on the product.
10. All cautions and warnings on the equipment should be noted.
11. If the equipment is not used for a long time, disconnect it from the power source to avoid damage by transient overvoltage.
12. Never pour any liquid into an opening. This may cause fire or electrical shock.
13. Never open the equipment. For safety reasons, the equipment should be opened only by qualified service personnel.
14. If one of the following situations arises, get the equipment checked by service personnel:
 - a. The power cord or plug is damaged.
 - b. Liquid has penetrated into the equipment.
 - c. The equipment has been exposed to moisture.
 - d. The equipment does not work well, or you cannot get it to work according to the user's manual.
 - e. The equipment has been dropped and damaged.
 - f. The equipment has obvious signs of breakage.
15. Do not place heavy objects on the equipment.
16. The unit uses a three-wire ground cable which is equipped with a third pin to ground the unit and prevent electric shock. Do not defeat the purpose of this pin. If your outlet does not support this kind of plug, contact your electrician to replace your obsolete outlet.
17. **CAUTION:** DANGER OF EXPLOSION IF BATTERY IS INCORRECTLY REPLACED. REPLACE ONLY WITH THE SAME OR EQUIVALENT TYPE RECOMMENDED BY THE MANUFACTURER. DISCARD USED BATTERIES ACCORDING TO THE MANUFACTURER'S INSTRUCTIONS.
18. Ensure to connect the power cord of the power adapter to a socket-outlet with earthing connection.
19. This product is intended to be supplied by a Listed Power Adapter or DC power source, rated 19Vdc, minimum 2.37A, minimum T ma=50 degree C, minimum altitude of operation=2000m, and evaluated in accordance to UL/IEC 60950-1 and/or UL/IEC 62368-1. If further assistance is needed, please contact NEXCOM International Co., Ltd. (UL file owner or brand owner) for further information.

Technical Support and Assistance

1. For the most updated information of NEXCOM products, visit NEXCOM's website at www.nexcom.com.
2. For technical issues that require contacting our technical support team or sales representative, please have the following information ready before calling:
 - Product name and serial number
 - Detailed information of the peripheral devices
 - Detailed information of the installed software (operating system, version, application software, etc.)
 - A complete description of the problem
 - The exact wordings of the error messages

Warning!

1. Handling the unit: carry the unit with both hands and handle it with care.
2. Maintenance: to keep the unit clean, use only approved cleaning products or clean with a dry cloth.

Conventions Used in this Manual



Warning:

Information about certain situations, which if not observed, can cause personal injury. This will prevent injury to yourself when performing a task.



Caution:

Information to avoid damaging components or losing data.



Note:

Provides additional information to complete a task easily.

Global Service Contact Information

Headquarters

NEXCOM International Co., Ltd.

9F, No. 920, Chung-Cheng Rd.,
Zhonghe District, New Taipei City, 23586,
Taiwan, R.O.C.
Tel: +886-2-8226-7786
Fax: +886-2-8226-7782
www.nexcom.com

Asia

Taiwan

NexAIoT Headquarters

Industry 4.0 and Cloud Services

13F, No.916, Zhongzheng Rd.,
Zhonghe District, New Taipei City,
23586, Taiwan, R.O.C.
Tel: +886-2-8226-7796
Fax: +886-2-8226-7926
Email: sales@nexaiot.com
www.nexaiot.com

NexAIoT Co., Ltd.

Taichung Office

16F, No.250, Sec. 2, Chongde Rd.,
Beitun District,
Taichung City, 406, Taiwan, R.O.C.
Tel: +886-4-2249-1179
Fax: +886-4-2249-1172
Email: sales@nexaiot.com
www.nexaiot.com

NexCOBOT Taiwan Co., Ltd.

13F, No.916, Chung-Cheng Rd.,
Zhonghe District,
New Taipei City, 23586, Taiwan, R.O.C.
Tel: +886-2-8226-7786
Fax: +886-2-8226-7926
Email: sales@nexcobot.com
www.nexcobot.com

GreenBase Technology Corp.

13F, No.922, Chung-Cheng Rd.,
Zhonghe District,
New Taipei City, 23586, Taiwan, R.O.C.
Tel: +886-2-8226-7786
Fax: +886-2-8226-7900
Email: sales@nexcom.com.tw
www.nexcom.com.tw

EMBUX Technology Co., Ltd.

13F, No.916, Chung-Cheng Rd.,
Zhonghe District,
New Taipei City, 23586, Taiwan, R.O.C.
Tel: +886-2-8226-7786
Fax: +886-2-8226-7782
Email: sales@nexcom.com.tw
www.nexcom.com.tw

TMR Technology Corp.

13F, No.916, Chung-Cheng Rd.,
Zhonghe District,
New Taipei City, 23586, Taiwan, R.O.C.
Tel: +886-2-8226-7786
Fax: +886-2-8226-7782
Email: sales@nexcom.com.tw
www.nexcom.com.tw

China

NEXSEC Incorporated

5F, No.4, No.7 Fengxian Middle Rd.,
(Beike Industrial Park), Haidian District,
Beijing, 100094, China
Tel: +86-10-5704-2680
Fax: +86-10-5704-2681
Email: marketing@nexsec.cn
www.nexsec.cn

NEXCOM Shanghai

No.4, 16 Building,
Shanghai OMNI Tech & Science Park
No. 1699, Douhui Rd.,
Shanghai, 201108, China
Tel: +86-21-5278-5868
Fax: +86-21-3251-6358
Email: sales@nexcom.cn
www.nexcom.cn

NEXCOM Surveillance Technology Corp.

5F, Building C, ZhenHan Industrial Zone,
GanKeng Community, Buji Street,
LongGang District,
ShenZhen, 518112, China
Tel: +86-755-8364-7768
Fax: +86-755-8364-7738
Email: steveyang@nexcom.com.tw
www.nexcom.cn

NEXCOM United System Service

Room 603/604, Huiyinmingzun Plaza Bldg. 1,
No. 609, Yunlin East Rd.,
Shanghai, 200062, China
Tel: +86-21-5278-5868
Fax: +86-21-3251-6358
Email: renwang@nexcom.com.tw
www.nexcom.cn

NEXGOL Chongqing

1F, Building B4, Electronic 2nd Area,
(Phoenix Lake Industrial Park), Yongchuan Dist.,
Chongqing City, 402160, China
Tel: +86-23-4960-9080
Fax: +86-23-4966-5855
Email: sales@nexgol.com.cn
www.nexcobot.com/NexGOL

NexCOBOT China

Room 501, Building 1, Haichuang Building,
No.7 Qingyi Road, Guicheng Street,
Nanhai District, Foshan City,
Guangdong Province, 528314, China
Tel: +86-757-8625-7118
Email: sales@nexcobot.com
www.nexcobot.com.cn

Beijing NexGemo Technology Co.,Ltd.

5F, Gemotech Building, No.1, Development Rd.,
Changping International Information Industry Base,
Changping District,
Beijing, 102206, China
Tel: +86-10-8190-9328
Fax: +86-10-8190-9456
Email: sales@gemotech.cn
www.nexgemo.cn

Japan

NEXCOM Japan

9F, Tamachi Hara Bldg.,
4-11-5, Shiba Minato-ku,
Tokyo, 108-0014, Japan
Tel: +81-3-5419-7830
Fax: +81-3-5419-7832
Email: sales@nexcom-jp.com
www.nexcom-jp.com

America

USA NEXCOM USA

46665 Fremont Blvd.,
Fremont CA 94538, USA
Tel: +1-510-656-2248
Fax: +1-510-656-2158
Email: sales@nexcom.com
www.nexcomusa.com

Europe

United Kingdom NEXCOM EUROPE

10 Vincent Avenue,
Crownhill Business Centre,
Milton Keynes, Buckinghamshire
MK8 0AB, United Kingdom
Tel: +44-1908-267121
Fax: +44-1908-262042
Email: sales.uk@nexcom.eu
www.nexcom.co.uk

Package Contents

Before continuing, verify that the Neu-X101 package that you received is complete. Your package should have all the items listed in the following table.

Item	Part Number	Name	Description	Qty
	10W10X10100X0	Neu-X101 System	Fanless Box PC, 3.5" Board, J3455	1
1	5060200184X00	Thermal Pad for Memory	Thermal Pad E-LIN 60x20x1.5mm S35 K=2.0w/mk	1
2	5060200417X00	Thermal Pad for M.2	Thermal Pad T-Global:TG4040 30x25x1.5mm K=4 w/mK-UL	1
3	7400060057X00	Power Adapter	Power Adapter for NDiS B116 EDAC:EA10681N(T42)	1
4	5040420019X00	Mini-Card Bracket	Mini-Card Bracket for NDiS M323 VER:A CHYUAN-JYH 29x30x2.1mm t=1.0mm SPCC+NI	1
5	50311F0295X00	Screw	Flat Head Screw Long Fei: 2x4 Nylok NIGP F2x4 NIGP Nylok	2

Ordering Information

The following below provides ordering information for Neu-X101.

Neu-X101 (P/N: 10W10X10100X0)

Intel® Apollo Lake J3455 processor slim and fanless system

AI Booster Card

AIBooster®-X1 (P/N: 88W10X10000X0)

Intel® Movidius™ Myriad™ X VPU, mini-PCIe module (1 x MA2485)

AIBooster®-X2 (P/N: 88W10X10001X0)

Intel® Movidius™ Myriad™ X VPU, mini-PCIe module (2 x MA2485)

CHAPTER 1: PRODUCT INTRODUCTION

Neu-X101

Overview



Key Features

- Intel® Apollo Lake J3455 Processor
- Slim chassis design
- Support 2x HDMI 1.4b output
- Support power input 12 VDC
- Fanless design
- 1 x DDR3L up to 8GB, M.2 2242 Key M for storage device
- Mini-PCle slot supports Wi-Fi and LTE module

Hardware Specifications

CPU Support

- Intel® Apollo Lake J3455 Processor (2.30GHz, 10W)

Graphics

- Intel® HD Graphics 500

Main Memory

- 1x 204-pin SO-DIMM socket, supports up to DDR3L 1866MHz, non-ECC, un-buffered memory up to 8GB

I/O Interface-Front

- 2 x RJ45 with LEDs for Gigabit LAN
- 2 x HDMI 1.4b, 3840 x 2160 resolution @ 30Hz
- 1 Power button with LED
- 1 x DC-in jack with lock
- 2 x USB 3.0
- 2 x USB 2.0

I/O Interface-Rear

- 2 x Antenna holes
- 1 x COM port (RS232/RS422/RS485)
- 1 x Storage active LED

Internal I/O

- 1 x COM port connector (RS232, RI/5V/12V)
- 1 x TPM module connector
- 1 x Line-out audio connector

Expansion

- 1 x Mini-PCIe full-size connector, supports Wi-Fi/LTE module
- 1 x SIM slot on board (nano)

Storage

- 1 x M.2 M key 2242

Power Supply

- 1 x External 60W AC/DC power adapter with lock (power adapter is included in accessory)
- Input: 100VAC to 240VAC
- Output: DC+12VDC

Environment

- Operating temperature: -5°C to 50°C ambient with air flow
- Storage temperature: -20°C to 80°C
- Humidity: 95% (non-condensing)
- Shock protection: 50G peak acceleration, 11ms according to IEC60068-2-27
- Vibration protection
 - Random: 2Grms @ 5~500 Hz, IEC60068-2-64
 - Sinusoidal: 2G @ 5~500 Hz, IEC60068-2-6

Certification

- CE (EMC EN55035 + EN55032)
- FCC Class A (EMI Part 15B)
- LVD (EN62368-1)



Dimensions

- 155mm (W) x 106mm (D) x 37mm (H)

Operating System

- Windows 10 64-bit
- Linux 4.1

Physical Features

Front Panel

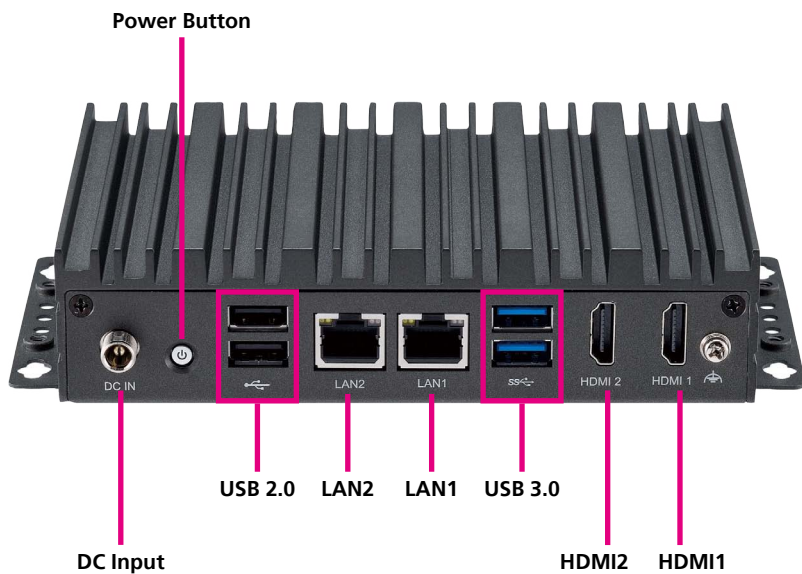

Rear Panel



Mechanical Dimensions

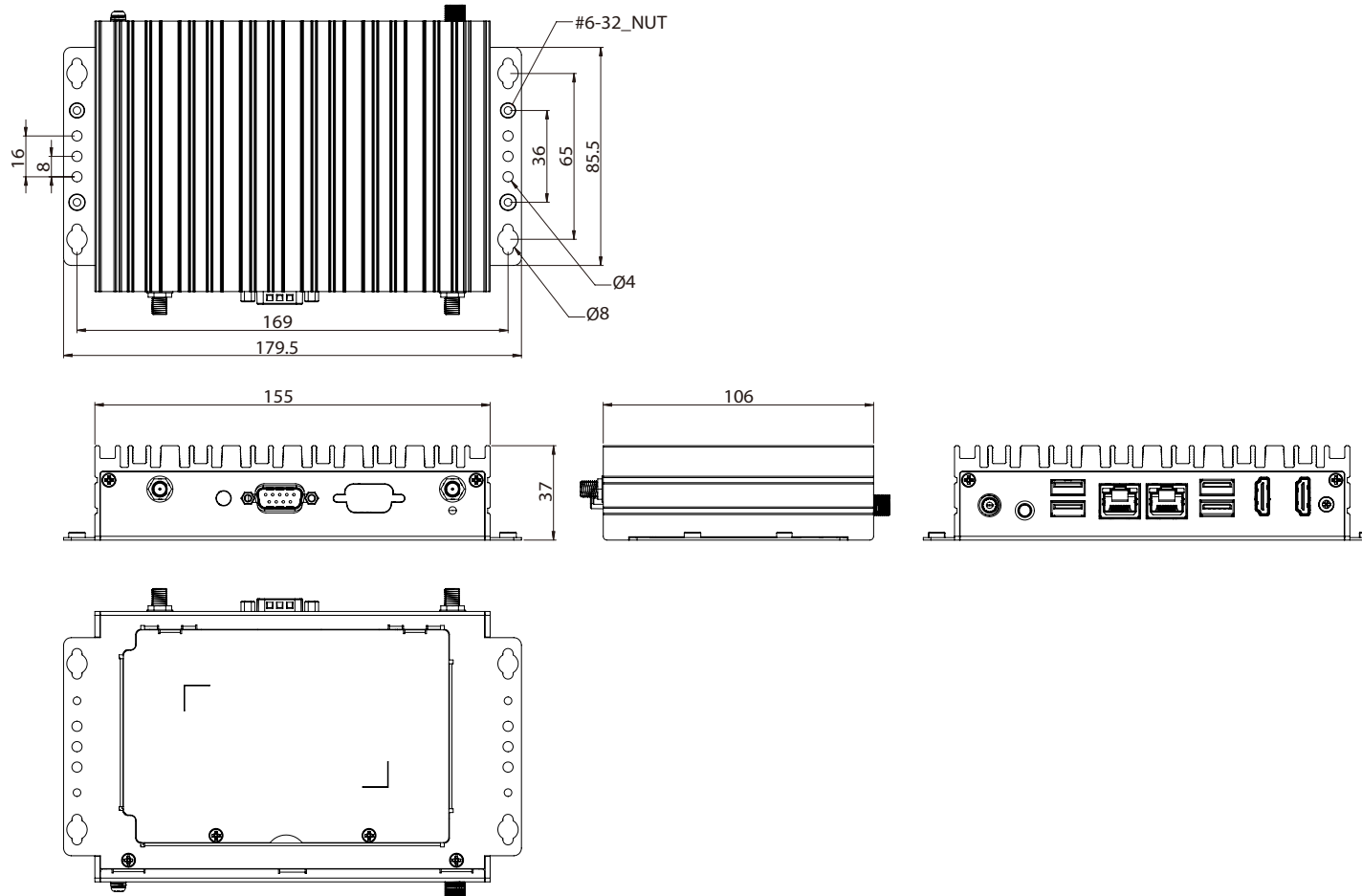

CHAPTER 2: JUMPERS AND CONNECTORS

This chapter lists the locations of the jumpers and connectors for Neu-X101.

Before You Begin

- Ensure you have a stable, clean working environment. Dust and dirt can get into components and cause a malfunction. Use containers to keep small components separated.
- Adequate lighting and proper tools can prevent you from accidentally damaging the internal components. Most of the procedures that follow require only a few simple tools, including the following:
 - A Philips screwdriver
 - A flat-tipped screwdriver
 - A set of jewelers screwdrivers
 - A grounding strap
 - An anti-static pad
- Using your fingers can disconnect most of the connections. It is recommended that you do not use needle-nosed pliers to disconnect connections as these can damage the soft metal or plastic parts of the connectors.
- Before working on internal components, make sure that the power is off. Ground yourself before touching any internal components, by touching a metal object. Static electricity can damage many of the electronic components. Humid environments tend to have less static electricity than dry environments. A grounding strap is warranted whenever danger of static electricity exists.

Precautions

Computer components and electronic circuit boards can be damaged by discharges of static electricity. Working on computers that are still connected to a power supply can be extremely dangerous.

Follow the guidelines below to avoid damage to your computer or yourself:

- Always disconnect the unit from the power outlet whenever you are working inside the case.
- If possible, wear a grounded wrist strap when you are working inside the computer case. Alternatively, discharge any static electricity by touching the bare metal chassis of the unit case, or the bare metal body of any other grounded appliance.
- Hold electronic circuit boards by the edges only. Do not touch the components on the board unless it is necessary to do so. Don't flex or stress the circuit board.
- Leave all components inside the static-proof packaging that they shipped with until they are ready for installation.
- Use correct screws and do not over tighten screws.

Jumper Settings

A jumper is the simplest kind of electric switch. It consists of two metal pins and a cap. When setting the jumpers, ensure that the jumper caps are placed on the correct pins. When the jumper cap is placed on both pins, the jumper is short. If you remove the jumper cap, or place the jumper cap on just one pin, the jumper is open.

Refer to the illustrations below for examples of what the 2-pin and 3-pin jumpers look like when they are short (on) and open (off).

Two-Pin Jumpers: Open (Left) and Short (Right)

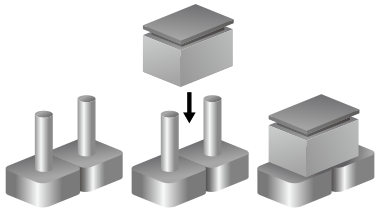

Three-Pin Jumpers: Pins 1 and 2 are Short

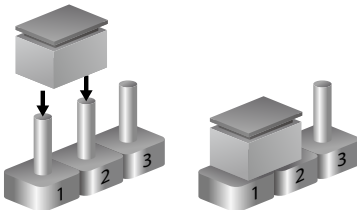

Locations of the Jumpers and Connectors for Neu-X101

The figure below is the top and bottom view of the mainboard used in Neu-X101. It shows the locations of the jumpers and connectors.

Top View

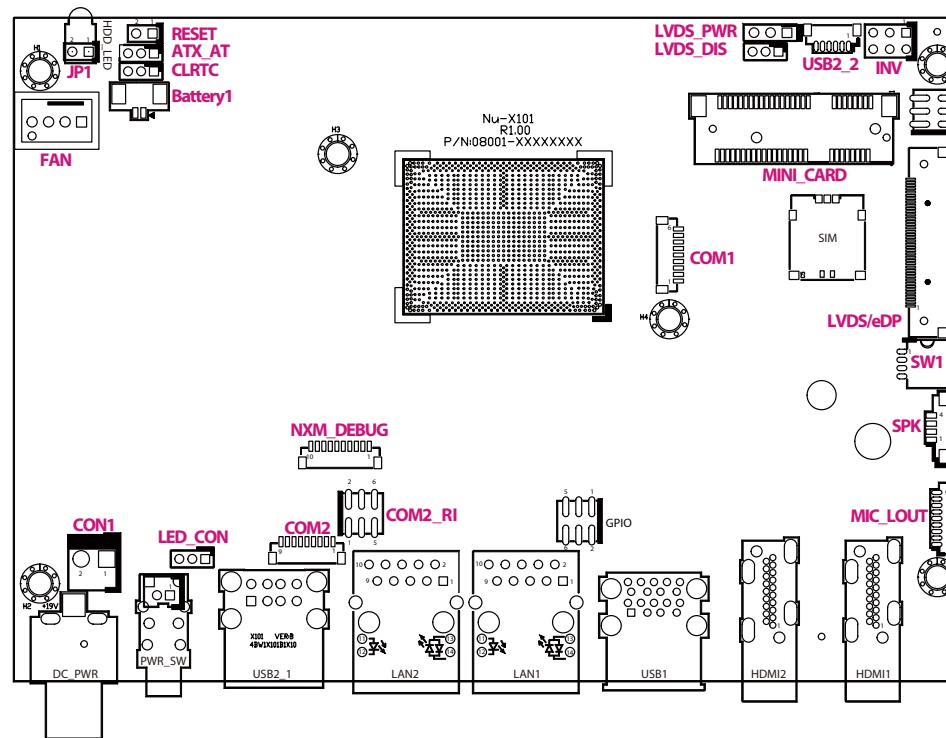

Bottom View

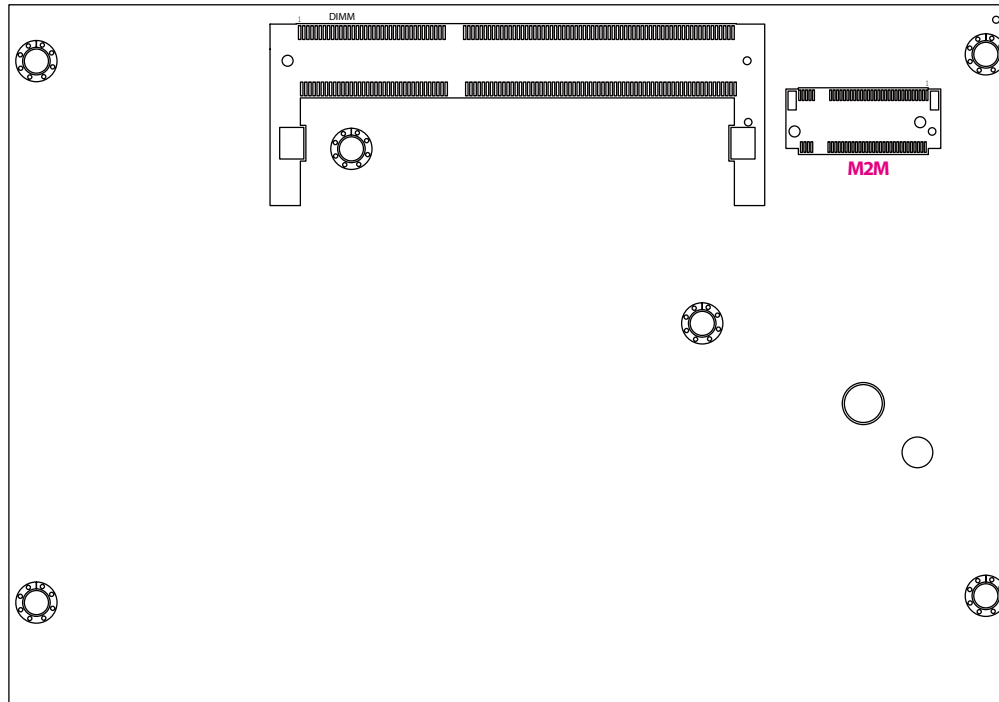

Jumpers & DIP Switches

AT/ATX Mode Select

Connector type: 1x3 3-pin header, 2.0mm pitch

Connector location: ATX_AT



Pin	Settings
1-2 On	ATX Mode
2-3 On	AT Mode

1-2 On: default

Clear CMOS

Connector type: 1x3 3-pin header, 2.0mm pitch

Connector location: CLRTC



Pin	Settings
1-2 On	Normal
2-3 On	Clear CMOS

1-2 On: default

LVDS Panel Voltage Select

Connector type: 1x3 3-pin header, 2.54mm pitch
Connector location: LVDS_PWR



Pin	Settings
1-2 On	3.3V
2-3 On	5V

1-2 On: default

LVDS Enable Select

Connector type: 1x3 3-pin header, 2.0mm pitch
Connector location: LVDS_DIS



Pin	Settings
1-2 On	Enable
2-3 On	Disable

1-2 On: default

LVDS Resolution Select

Connector type: 4-pin DIP switch

Connector location: SW1

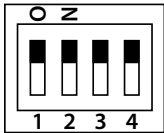

SW [3:0]	SW1 [3]	SW1 [2]	SW1 [1]	SW1 [0]	HA	VA	CD(bit)	port
0000	ON	ON	ON	ON	800	600	6	single
0001	ON	ON	ON	OFF	1024	768	6	single
0010	ON	ON	OFF	ON	1024	768	8	single
0011	ON	ON	OFF	OFF	1280	1024	6	single
0100	ON	OFF	ON	ON	1280	800	6	single
0101	ON	OFF	ON	OFF	1280	800	8	single
0110	ON	OFF	OFF	ON	1280	1024	8	dual
0111	ON	OFF	OFF	OFF	1366	768	6	single
1000	OFF	ON	ON	ON	1366	768	8	single
1001	OFF	ON	ON	OFF	1440	900	8	dual
1010	OFF	ON	OFF	ON	1400	1050	8	dual
1011	OFF	ON	OFF	OFF	1600	900	8	dual
1100	OFF	OFF	ON	ON	1680	1050	8	dual
1101	OFF	OFF	ON	OFF	1600	1200	8	dual
1110	OFF	OFF	OFF	ON	1920	1080	8	dual
1111	OFF	OFF	OFF	OFF	1920	1200	8	dual

Connector Pin Definitions

Internal Connectors

LVDS Inverter Connector

Connector type: 2x3 6-pin header JST, 2.54mm pitch

Connector location: INV

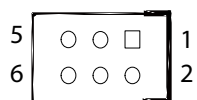

Pin	Definition	Pin	Definition
1	GND	2	GND
3	12V	4	12V
5	INV_ENABKL	6	BKLTCTRL_V

System Reset Header

Connector type: 1x2 2-pin header, 2.54mm pitch

Connector location: RESET

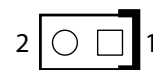

Pin	Definition
1	RESET#
2	GND

Power LED Connector

Connector type: 1x3 3-pin header, 2.0mm pitch

Connector location: LED_CON



Pin	Definition
1	POWER_LED
2	STBY_LED_8
3	GND

COM1 Connector

Connector type: WTOB CON, 9-pin, 1.0mm

Connector location: COM1

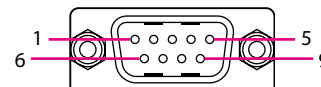

RS232		RS422		RS485	
Pin	Definition	Pin	Definition	Pin	Definition
1	DCD	1	TX-	1	TR-
2	RXD	2	TX+	2	TR+
3	TXD	3	RX+	3	
4	DTR	4	RX-	4	
5	GND	5		5	
6	DSR	6		6	
7	RTS	7		7	
8	CTS	8		8	
9	RI	9		9	

DC Power Input

Connector type: 1x2 2-pin header, 3.96mm pitch

Connector location: CON1

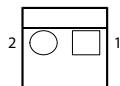

Pin	Definition
1	GND
2	+DC_IN

FAN Connector

Connector type: 1x4 4-pin header

Connector location: FAN

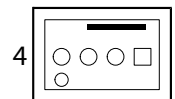

Pin	Definition	Pin	Definition
1	GND	2	12V
3	FANIN	4	FANOUT

Debug Port/LPC Bus Connector

Connector type: 1x10 10-pin header, 1.0mm pitch

Connector location: NXM_DEBUG

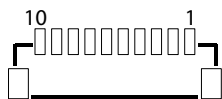

Pin	Definition	Pin	Definition
1	+3V	2	SERIRQ
3	LAD0	4	LAD1
5	LAD2	6	LAD3
7	LFRAME#	8	25MHZ
9	PLTRST#	10	GND

COM Port Connector

Connector type: 1x9 9-pin header, 1.0mm pitch

Connector location: COM2



Pin	Definition	Pin	Definition
1	DCD	2	RXD
3	TXD	4	DTR
5	GND	6	DSR
7	RTS	8	CTS
9	RI		

USB2.0 Connector

Connector type: 1x6 6-pin header

Connector location: USB2_2

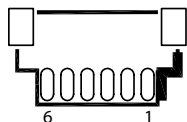

Pin	Definition	Pin	Definition
1	GND	2	S_USB2DN5
3	S_USB2DP5	4	S_USB2DN4
5	S_USB2DP4	6	+5V_USB2_P45

BIOS update connector

Connector type: 2x4 8-pin header, 1.27mm pitch

Connector location: SPI

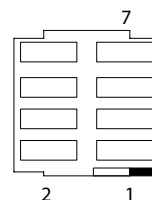

Pin	Definition	Pin	Definition
1	+1.8V_SPI	2	SPI_CS0#_F
3	SPI_HOLD#	4	SPI_SO_F
5	SPI_CLK_F	6	SPI_D2_WP#
7	SPI_SI_F	8	GND

SIM Card Connector

Connector type: 2x3 6-pin header, 2.0mm pitch

Connector location: SIM1

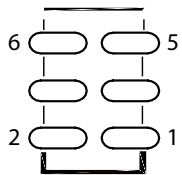

Pin	Definition	Pin	Definition
1	UIM_DATA_R	2	UIM_CLK_R
3	UIM_VPP_R	4	UIM_RESET_R
5	GND	6	UIM_PWR_R

GPIO Connector

Connector type: 2x3 6-pin header, 2.0mm pitch

Connector location: GPIO

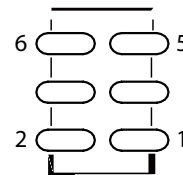

Pin	Definition	Pin	Definition
1	GPIO_PWR	2	GPIO_GND
3	GPO0_OUT	4	GPIO_IN
5	GPO1_OUT	6	GPI1_IN

Audio MIC Line Out Connector

Connector type: 1x9 9-pin header, 1.0mm pitch

Connector location: MIC_LOUT

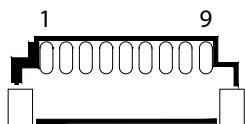

Pin	Definition	Pin	Definition
1	A_LOUT_R	2	LINEOUT_JD
3	NC	4	A_LOUT_L
5	GND	6	A_MIC1_R
7	MIC_JD	8	A_MIC1_L
9	GND		

Speaker Connector

Connector type: 1x4 4-pin header, 1.25mm pitch

Connector location: SPK

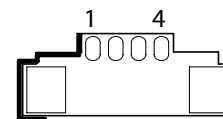

Pin	Definition	Pin	Definition
1	LOUTP_40	2	LOUTN_40
3	ROUTP_40	4	ROUTN_40

Battery Connector

Connector type: 1x2 2-pin header, 1.25mm pitch

Connector location: BATTERY1

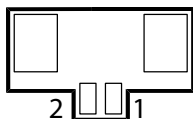

Pin	Definition
1	BAT
2	GND

LVDS Panel Connector

Connector type: 1x40 40-pin header, 0.5mm pitch

Connector location: LVDS

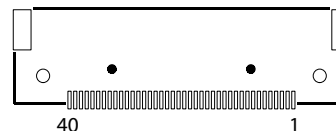

Pin	Definition	Pin	Definition
1	LVDS0_D3+	2	LVDS0_D3-
3	LVDS0_D2+	4	LVDS0_D2-
5	LVDS0_D1+	6	LVDS0_D1-
7	LVDS0_D0+	8	LVDS0_D0-
9	LVDS1_D3+	10	LVDS1_D3-
11	LVDS1_D2+	12	LVDS1_D2-
13	LVDS1_D1+	14	LVDS1_D1-
15	LVDS1_D0+	16	LVDS1_D0-
17	GND	18	+V_PANEL (3.3V or 5V)
19	+V_PANEL (3.3V or 5V)	20	+V_PANEL (3.3V or 5V)
21	GND	22	+V_PANEL (3.3V or 5V)
23	GND	24	GND
25	GND	26	LVDS0_CLK+
27	LVDS0_CLK-	28	GND
29	GND	30	GND
31	N/A	32	Backlight Enable
33	Backlight Control	34	LVDS1_CLK+
35	LVDS1_CLK-	36	+12V
37	+12V	38	+12V
39	+12V	40	N/A

COMPORT Ring Connector

Connector type: 2x3 6-pin, 2.00mm pitch

Connector location: COM2_RI

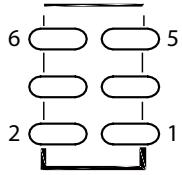

Pin	Definition	Pin	Definition
1	12V	2	RI_COMPORT
3	5V	4	RI_COMPORT
5	RI	6	RI_COMPORT

eDP Panel Connector

Connector location: eDP

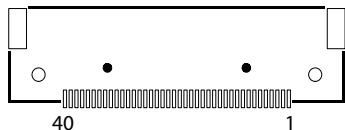

Pin	Definition	Pin	Definition
1	EDP_3N	2	EDP_3P
3	GND	4	EDP_2N
5	EDP_2P	6	GND
7	EDP_1N	8	EDP_1P
9	GND	10	EDP_ON
11	EDP_OP	12	GND
13	N/A	14	N/A
15	N/A	16	N/A
17	GND	18	+V_PANEL (3.3V or 5V)
19	+V_PANEL (3.3V or 5V)	20	+V_PANEL (3.3V or 5V)
21	GND	22	N/A
23	GND	24	GND
25	GND	26	EDP_AUXP

Pin	Definition	Pin	Definition
27	EDP_AUXN	28	GND
29	GND	30	GND
31	EDP_HPD	32	Back Light Enable
33	Back Light PWM	34	N/A
35	N/A	36	+12V
37	+12V	38	+12V
39	+12V	40	N/A

Mini-PCIe Connector

Connector location: MINI_CARD

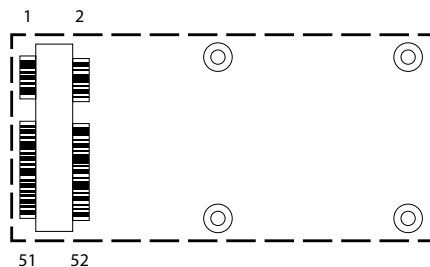

Pin	Definition	Pin	Definition
1	WAKE#	2	+3VSB
3	NC	4	GND
5	NC	6	+1.5V
7	NC	8	SIM_PWR
9	GND	10	SIM_DATA
11	REFCLK-	12	SIM_CLK
13	REFCLK+	14	SIM_RESET
15	GND	16	SIM_VPP
17	NC	18	GND
19	NC	20	WLAN_DISABLE#
21	GND	22	RESET#
23	PERn0	24	+3VSB
25	PERp0	26	GND

Pin	Definition	Pin	Definition
27	GND	28	+1.5V
29	GND	30	SMB_CLK
31	PETn0	32	SMB_DATA
33	PETp0	34	GND
35	GND	36	USB_D-
37	GND	38	USB_D+
39	+3VSB	40	GND
41	+3VSB	42	NC
43	GND	44	NC
45	NC	46	NC
47	NC	48	+1.5V
49	NC	50	GND
51	NC	52	+3VSB

M.2 Connector (M-Key)

Connector location: M2M

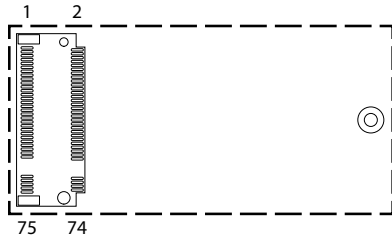

Pin	Definition	Pin	Definition
1	GND	2	+3VSB
3	GND	4	+3VSB
5	NC	6	NC
7	NC	8	NC
9	GND	10	M2M_LED#
11	NC	12	+3VSB
13	NC	14	+3VSB
15	GND	16	+3VSB
17	NC	18	+3VSB
19	NC	20	NC
21	GND	22	NC
23	NC	24	NC
25	NC	26	NC
27	GND	28	NC
29	NC	30	NC
31	NC	32	NC
33	GND	34	NC
35	NC	36	NC
37	NC	38	DEVS LP

Pin	Definition	Pin	Definition
39	GND	40	NC
41	SATA_RXP	42	NC
43	SATA_RXN	44	NC
45	GND	46	NC
47	SATA_TXN	48	NC
49	SATA_TXP	50	RESET#
51	GND	52	NC
53	NC	54	NC
55	NC	56	NC
57	GND	58	NC
67	NC	68	NC
69	NC	70	+3VSB
71	GND	72	+3VSB
73	GND	74	+3VSB
75	GND		

Block Diagram

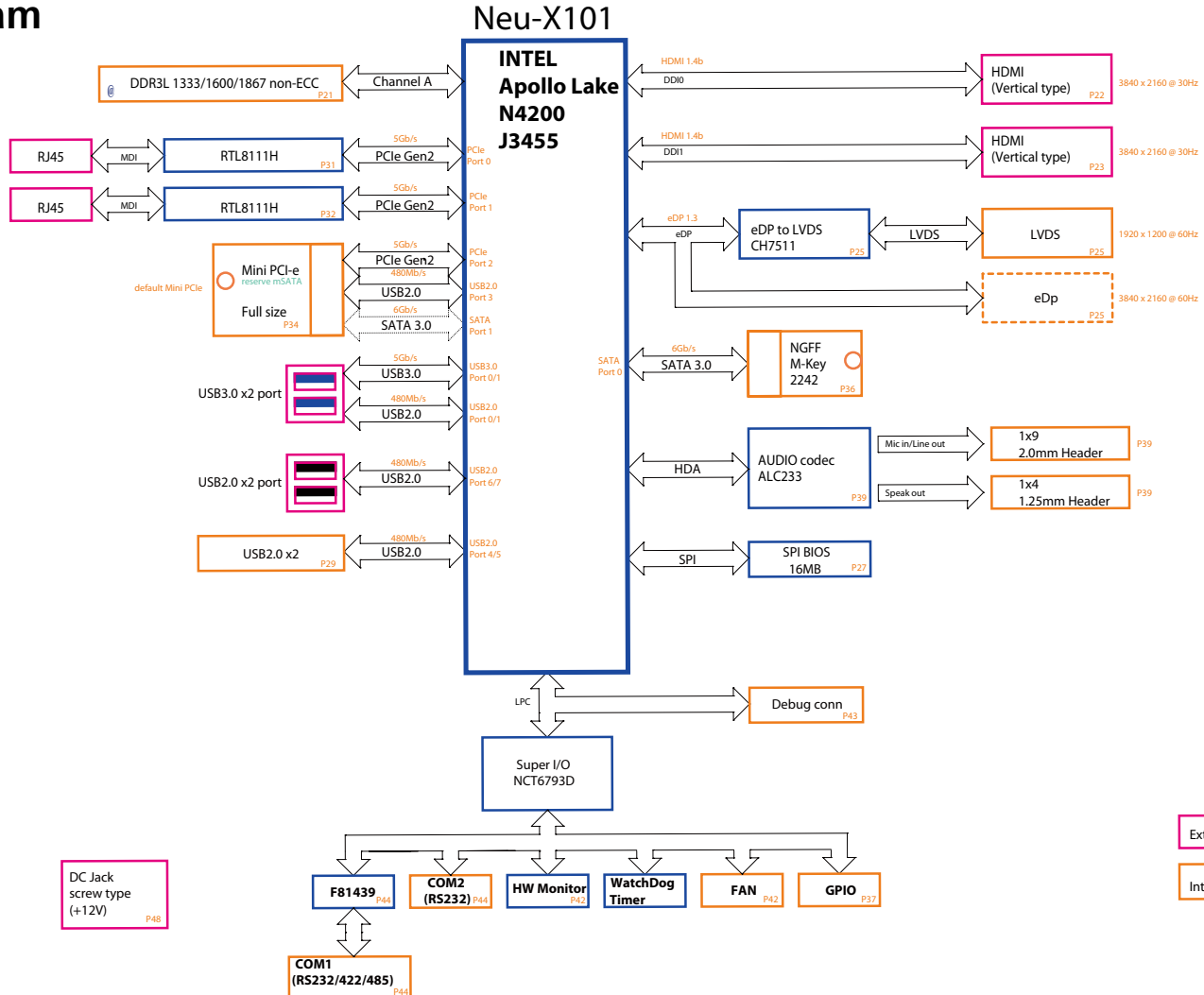

CHAPTER 3: SYSTEM SETUP

Installing a SO-DIMM Memory Module & M.2 M Key SSD Module (2240)

1. On the bottom of the system, loosen the screws on the bottom cover, and remove the cover from the chassis.
2. Insert the M.2 SSD module into the M.2 slot at a 45 degree angle until the gold-plated connector on the edge of the module completely disappears inside the slot. With the module fully inserted, tighten a screw into the mounting hole on the module to secure it.

Then, install a memory module into the SO-DIMM socket. Insert the module into the socket at an approximately 30 degree angle. Push the module down until the clips on both sides of the socket lock into position. The gold-plated connector on the edge of the module will almost completely disappear inside the socket.

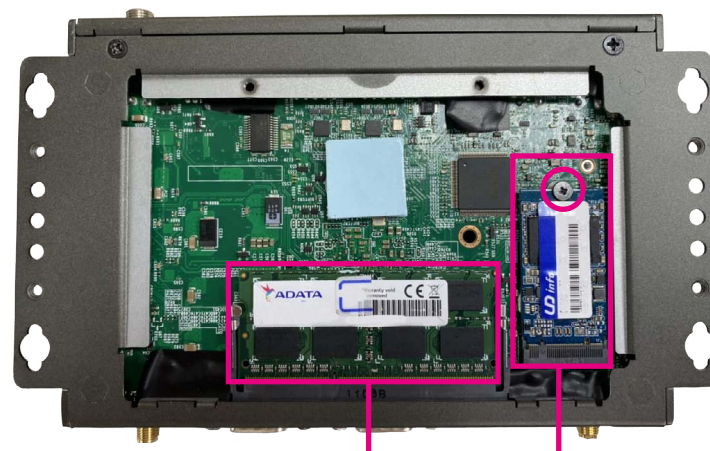
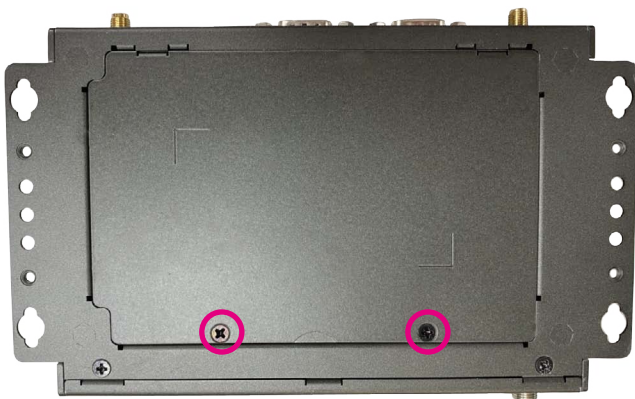

SO-DIMM Socket M.2 M Key Slot

Installing a Wi-Fi Module (Mini-PCle Slot)

1. Remove the 4 screws from the bottom cover.
2. With the chassis cover removed, locate the mini-PCle slot on the board. Insert the Wi-Fi module into the slot at a 45 degree angle until the gold-plated connector on the edge of the module completely disappears inside the slot. Tighten a screw into the mounting hole on the module to secure it. Attach the RF cables onto the Wi-Fi module and insert the antenna jack end of the cables through the antenna holes.



3. Insert the 2 rings (ring 1 then ring 2) into the Wi-Fi antenna jacks. Please remove the two antenna hole covers on the front panel before installing the antenna jacks.



4. Connect the external antennas to the Wi-Fi antenna jacks.



CHAPTER 4: BIOS SETUP

This chapter describes how to use the BIOS setup program for Neu-X101. The BIOS screens provided in this chapter are for reference only and may change if the BIOS is updated in the future.

To check for the latest updates and revisions, visit the NEXCOM website at www.nexcom.com.tw.

About BIOS Setup

The BIOS (Basic Input and Output System) Setup program is a menu driven utility that enables you to make changes to the system configuration and tailor your system to suit your individual work needs. It is a ROM-based configuration utility that displays the system's configuration status and provides you with a tool to set system parameters.

These parameters are stored in non-volatile battery-backed-up CMOS RAM that saves this information even when the power is turned off. When the system is turned back on, the system is configured with the values found in CMOS.

With easy-to-use pull down menus, you can configure such items as:

- Hard drives, diskette drives, and peripherals
- Video display type and display options
- Password protection from unauthorized use
- Power management features

The settings made in the setup program affect how the computer performs. It is important, therefore, first to try to understand all the setup options, and second, to make settings appropriate for the way you use the computer.

When to Configure the BIOS

- This program should be executed under the following conditions:
 - When changing the system configuration
 - When a configuration error is detected by the system and you are prompted to make changes to the setup program
 - When resetting the system clock
 - When redefining the communication ports to prevent any conflicts
 - When making changes to the Power Management configuration
 - When changing the password or making other changes to the security setup

Normally, CMOS setup is needed when the system hardware is not consistent with the information contained in the CMOS RAM, whenever the CMOS RAM has lost power, or the system features need to be changed.

Default Configuration

Most of the configuration settings are either predefined according to the Load Optimal Defaults settings which are stored in the BIOS or are automatically detected and configured without requiring any actions. There are a few settings that you may need to change depending on your system configuration.

Entering Setup











When the system is powered on, the BIOS will enter the Power-On Self Test (POST) routines. These routines perform various diagnostic checks; if an error is encountered, the error will be reported in one of two different ways:

- If the error occurs before the display device is initialized, a series of beeps will be transmitted.
- If the error occurs after the display device is initialized, the screen will display the error message.

Powering on the computer and immediately pressing allows you to enter Setup.

Press the  key to enter Setup:

Legends

Key	Function
	Moves the highlight left or right to select a menu.
	Moves the highlight up or down between sub-menus or fields.
	Exits the BIOS Setup Utility.
	Scrolls forward through the values or options of the highlighted field.
	Scrolls backward through the values or options of the highlighted field.
	Selects a field.
	Displays General Help.
	Load previous values.
	Load optimized default values.
	Saves and exits the Setup program.
	Press <Enter> to enter the highlighted sub-menu

Scroll Bar

When a scroll bar appears to the right of the setup screen, it indicates that there are more available fields not shown on the screen. Use the up and down arrow keys to scroll through all the available fields.

Submenu

When “▶” appears on the left of a particular field, it indicates that a submenu which contains additional options are available for that field. To display the submenu, move the highlight to that field and press  .

BIOS Setup Utility

Once you enter the AMI BIOS Setup Utility, the Main Menu will appear on the screen. The main menu allows you to select from several setup functions and one exit. Use arrow keys to select among the items and press  to accept or enter the submenu.

Main

The Main menu is the first screen that you will see when you enter the BIOS Setup Utility.

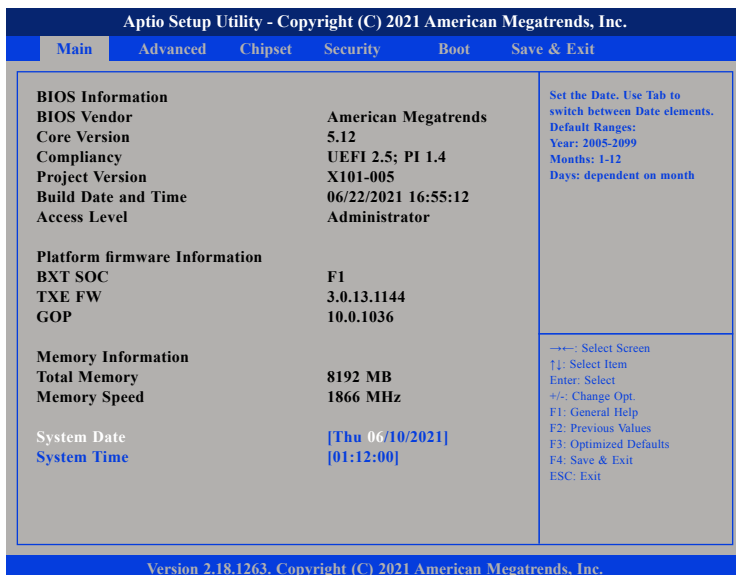

Aptio Setup Utility - Copyright (C) 2021 American Megatrends, Inc.					
Main	Advanced	Chipset	Security	Boot	Save & Exit
BIOS Information		American Megatrends		Set the Date. Use Tab to switch between Date elements.	
BIOS Vendor	5.12		Default Ranges:		
Core Version	UEFI 2.5; PI 1.4		Year: 2005-2099		
Compliance	X101-005		Months: 1-12		
Project Version	06/22/2021 16:55:12		Days: dependent on month		
Build Date and Time	Administrator				
Access Level					
Platform firmware Information		F1		←→: Select Screen	
BXT SOC	3.0.13.1144		↑↓: Select Item		
TXE FW	10.0.1036		Enter: Select		
GOP			+/-: Change Opt.		
Memory Information		8192 MB		F1: General Help	
Total Memory	1866 MHz		F2: Previous Values		
Memory Speed			F3: Optimized Defaults		
System Date	[Thu 06/10/2021]		F4: Save & Exit		
System Time	[01:12:00]		ESC: Exit		

Version 2.18.1263. Copyright (C) 2021 American Megatrends, Inc.

System Date

The date format is <day>, <month>, <date>, <year>. Day displays a day, from Monday to Sunday. Month displays the month, from January to December. Date displays the date, from 1 to 31. Year displays the year, from 2005 to 2099.

System Time

The time format is <hour>, <minute>, <second>. The time is based on the 24-hour military-time clock. For example, 1 p.m. is 13:00:00. Hour displays hours from 00 to 23. Minute displays minutes from 00 to 59. Second displays seconds from 00 to 59.

Advanced

The Advanced menu allows you to configure your system for basic operation. Some entries are defaults required by the system board, while others, if enabled, will improve the performance of your system or let you set some features according to your preference.



Setting incorrect field values may cause the system to malfunction.



Realtek PCIe GbE Family Controller

Displays the driver information of the Ethernet controller 1.

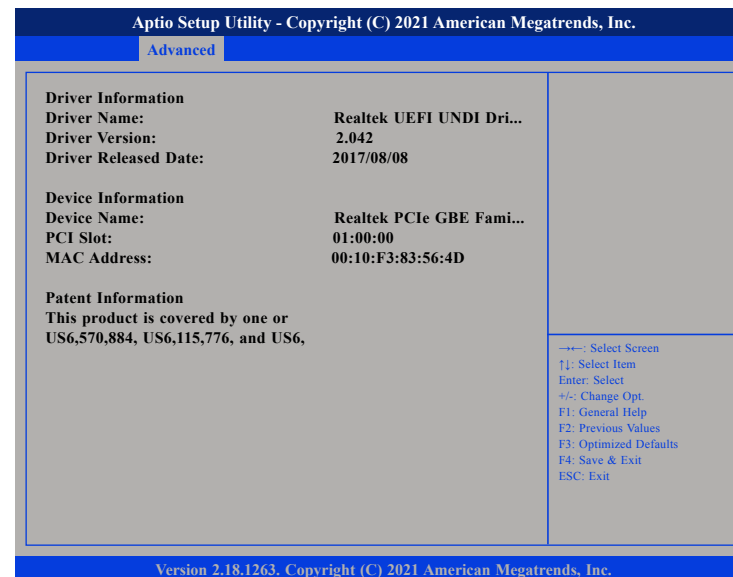

Restore AC Power Loss

Configures the power state when power is re-applied after a power failure.

NRealtek PCIe GbE Family Controller

Displays the driver information of the Ethernet controller 2.

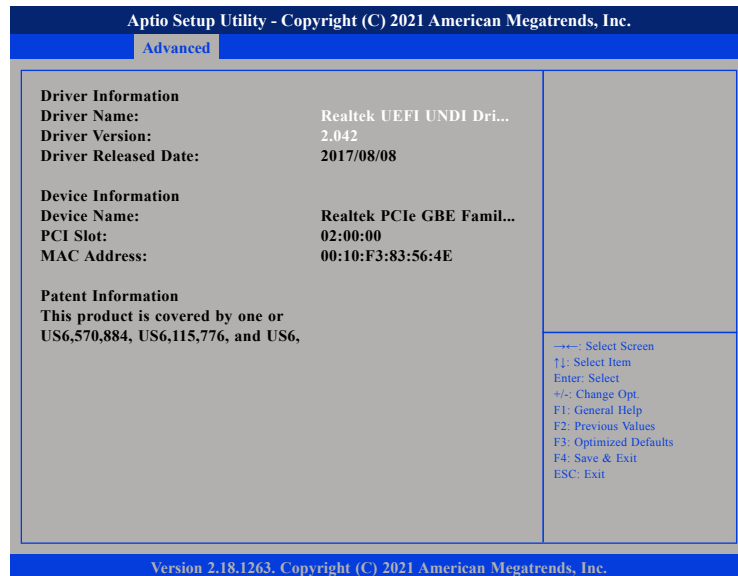

ACPI Settings

This section is used to configure ACPI settings.



Enable Hibernation

Enables or disables system ability to hibernate (OS/S4 Sleep State). This option may not be effective with some operating systems.

ACPI Sleep State

Select the highest ACPI sleep state the system will enter when the suspend button is pressed. The options are Suspend Disabled and S3 (Suspend to RAM).

NCT6793D Super IO Configuration

This section is used to configure the serial ports.



Super IO Chip

Displays the Super I/O chip used on the board.

Serial Port 1 Configuration



Serial Port

Enables or disables the serial COM port.

Device Settings

Displays the IO address and IRQ of the serial COM port.

Onboard Serial Port Mode

Select this to change the serial port mode to RS232, RS422, RS485 No Terminator or RS485 With Terminator.

Serial Port 2 Configuration



Serial Port

Enables or disables the serial COM port.

Device Settings

Displays the IO address and IRQ of the serial COM port.

Hardware Monitor

This section is used to monitor hardware status such as temperature, fan speed and voltages.

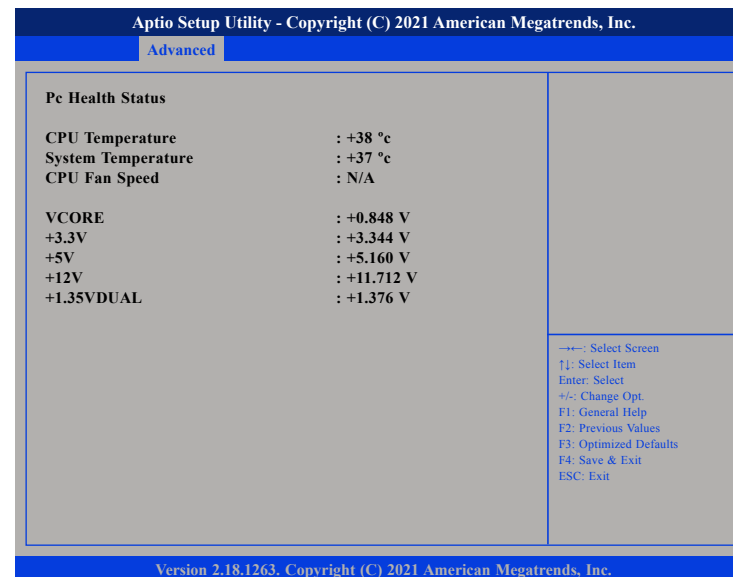

CPU Temperature

Detects and displays the current CPU temperature.

System Temperature

Detects and displays the current system temperature.

CPU Fan Speed

Detects and displays the current CPU fan speed.

VCORE to 1.35VDUAL

Detects and displays the output voltages.

S5 RTC Wake Settings

This section is used to configure the system to wake from S5 using RTC alarm.

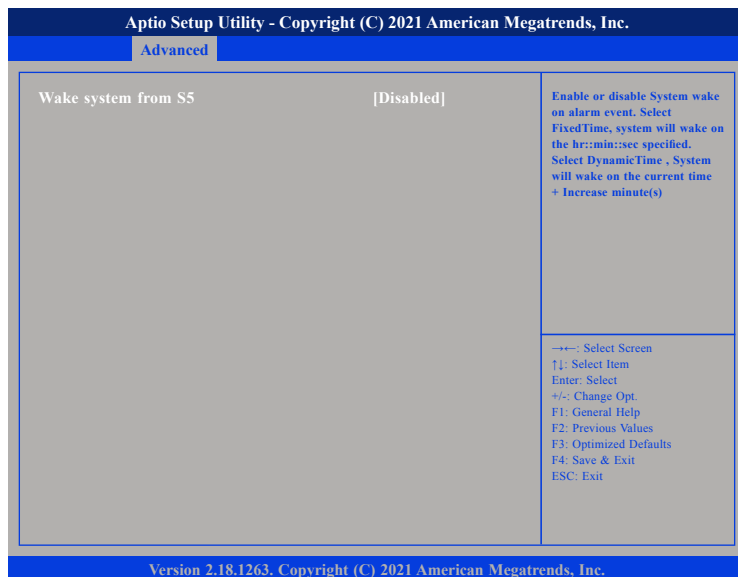

Wake system from S5

Enables or disables system wake on alarm event. When FixedTime is selected, system will wake on the hr::min::sec specified. When DynamicTime is selected, system will wake on the current time + Increase minute(s).

CPU Configuration

This section is used to view CPU status and configure CPU parameters.



Active Processor Cores

Select the number of cores to enable in each processor package.

Intel® Virtualization Technology

When this field is set to Enabled, the VMM can utilize the additional hardware capabilities provided by Vanderpool Technology.

VT-d

Enables or disables VT-d function on MCH.

P-STATE Coordination

Configures the P-STATE coordination type.

Socket 0 CPU Information

Display information on the CPU installed on socket 0.

Aptio Setup Utility - Copyright (C) 2021 American Megatrends, Inc.

Advanced

Socket 0 CPU Information	
Intel(R) Celeron(R) CPU J3455E @ 1.50GHz	
CPU Signature	506CA
Microcode Patch	1A
Max CPU Speed	1500 MHz
Min CPU Speed	800 MHz
Processor Cores	4
Intel HT Technology	Not Supported
Intel VT-x Technology	Supported
L1 Data Cache	24 kB x 4
L1 Code Cache	32 kB x 4
L2 Cache	1024 kB x 2
L3 Cache	Not Present

→←: Select Screen
 ↑↓: Select Item
 Enter: Select
 +/-: Change Opt.
 F1: General Help
 F2: Previous Values
 F3: Optimized Defaults
 F4: Save & Exit
 ESC: Exit

Version 2.18.1263. Copyright (C) 2021 American Megatrends, Inc.

CPU Power Management

Aptio Setup Utility - Copyright (C) 2021 American Megatrends, Inc.

Advanced

CPU Power Management Configuration	
EIST	[Enabled]
Turbo Mode	[Enabled]

Enable/Disable Intel SpeedStep

→←: Select Screen
 ↑↓: Select Item
 Enter: Select
 +/-: Change Opt.
 F1: General Help
 F2: Previous Values
 F3: Optimized Defaults
 F4: Save & Exit
 ESC: Exit

Version 2.18.1263. Copyright (C) 2021 American Megatrends, Inc.

EIST

Enables or disables Intel® SpeedStep.

Turbo Mode

Enables or disables turbo mode.

Network Stack Configuration

This section is used to configure the network stack settings.

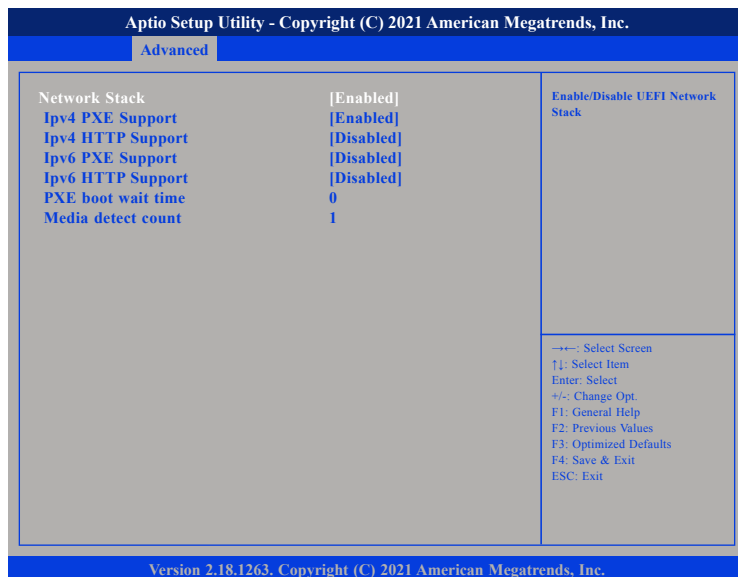

Ipv6 PXE Support

Enables or disables IPv6 PXE support. If disabled, the IPv6 boot option will not be created.

Ipv6 HTTP Support

Enables or disables Ipv6 HTTP support.

PXE boot wait time

Configures the wait time to press the ESC key to abort the PXE boot.

Media detect count

Configures the number of times the media will be checked.

Network Stack

Enables or disables UEFI network stack.

Ipv4 PXE Support

Enables or disables IPv4 PXE support. If disabled, the IPv4 boot option will not be created.

Ipv4 HTTP Support

Enables or disables Ipv4 HTTP support.

Trusted Computing

This section is used to configure Trusted Platform Module (TPM) settings.



Security Device Support

Enables or disables BIOS support for security device. O.S will not show Security Device. TCG EFI protocol and INT1A interface will not be available.

USB Configuration

This section is used to configure the USB.



XHCI Hand-off

This is a workaround for OSs that does not support XHCI hand-off. The XHCI ownership change should be claimed by the XHCI driver.

USB Mass Storage Driver Support

Enables or disables USB mass storage driver support.

USB transfer time-out

The time-out value for control, bulk, and Interrupt transfers.

Device reset time-out

Selects the USB mass storage device's start unit command timeout.

Device power-up delay

Maximum time the value will take before it properly reports itself to the Host Controller. "Auto" uses default value: for a Root port it is 100 ms, for a Hub port the delay is taken from Hub descriptor.

Chipset

This section is used to configure the system based on the specific features of the chipset.



Setting incorrect field values may cause the system to malfunction.

South Bridge

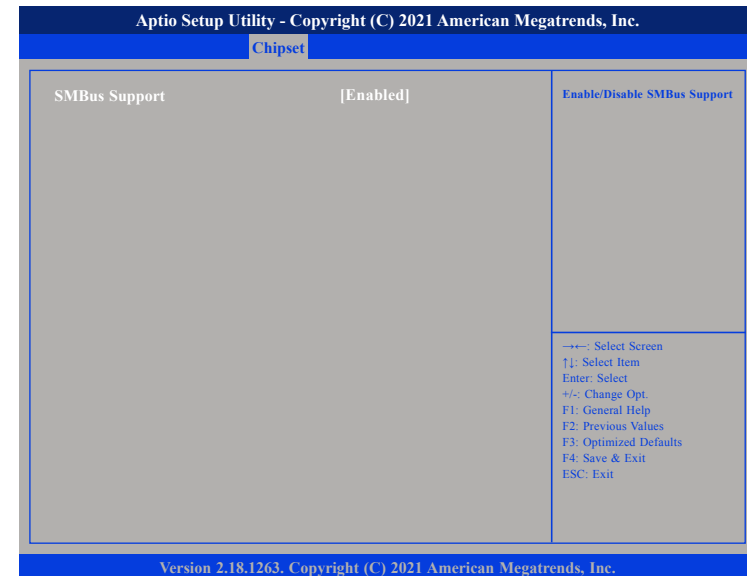

SMBus Support

Enables or disables SMBus support.

South Cluster Configuration



South Cluster Configuration



South Bridge

Enters the South Bridge submenu.

HD-Audio Configuration



HD-Audio Support

Enables or disables HD Audio support.

SATA Drives



Chipset SATA

Enables or disables the SATA controller chipset. The SATA controller chipset supports the 2 black internal SATA ports (up to 3Gb/s supported per port).

SATA Test Mode

Enables or disables SATA test mode.

Port 0

Enables or disables SATA port 0.

USB Configuration

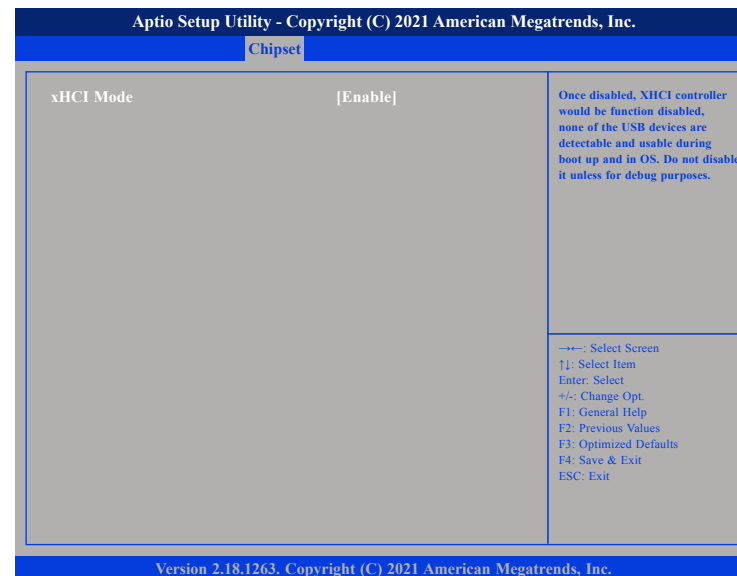

xHCI Mode

Enables or disables XHCI mode. Once disabled, XHCI controller function will be disabled and all the USB devices will not be detectable and usable during boot up and in OS. Please do not disable it unless for debugging purposes.

Miscellaneous Configuration



High Precision Timer

Enables or disables high precision event timer.

USB Power State in S5

Configures the USB power state in S5.

Security



Setup Administrator Password

Select this to reconfigure the administrator's password.

User Password

Select this to reconfigure the user's password.

Boot

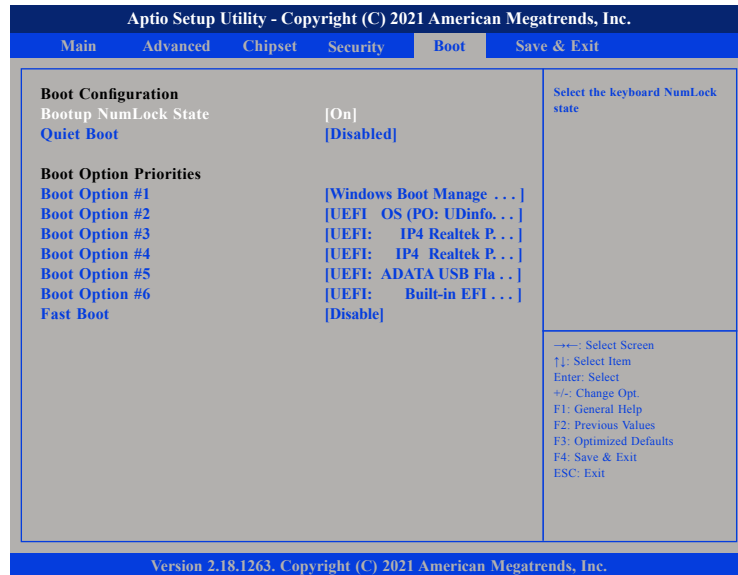

Bootup NumLock State

This allows you to determine the default state of the numeric keypad. By default, the system boots up with NumLock on wherein the function of the numeric keypad is the number keys. When set to Off, the function of the numeric keypad is the arrow keys

Quiet Boot

Enabled Displays OEM logo instead of the POST messages.
 Disabled Displays normal POST messages.

Boot Option Priorities

Adjust the boot sequence of the system. Boot Option #1 is the first boot device that the system will boot from, next will be #2 and so forth.

Fast Boot

Enables or disables boot with initialization of a minimal set of devices required to launch active boot option. Has no effect for BBS boot options.

Save & Exit



Save Changes and Reset

To save the changes and reset, select this field then press <Enter>. A dialog box will appear. Confirm by selecting Yes.

Discard Changes and Reset

To exit the Setup utility and reboot the system without saving the changes, select this field then press <Enter>. You may be prompted to confirm again before exiting.

Restore Defaults

To restore the BIOS to default settings, select this field then press <Enter>. A dialog box will appear. Confirm by selecting Yes.

Our company network supports you worldwide with offices in Germany, Austria, Switzerland, the UK and the USA. For more information please contact:

Headquarters

Germany



FORTEC Elektronik AG

Augsburger Str. 2b
82110 Germering

Phone: +49 89 894450-0
E-Mail: info@fortecaq.de
Internet: www.fortecaq.de

Fortec Group Members

Austria



**Distec GmbH,
Office Vienna**

Nuschinggasse 12
1230 Wien

Phone: +43 1 8673492-0
E-Mail: info@distec.de
Internet: www.distec.de

Germany



Distec GmbH

Augsburger Str. 2b
82110 Germering

Phone: +49 89 894363-0
E-Mail: info@distec.de
Internet: www.distec.de

Switzerland



ALTRAC AG

Bahnhofstraße 3
5436 Würenlos

Phone: +41 44 7446111
E-Mail: info@altrac.ch
Internet: www.altrac.ch

United Kingdom



Display Technology Ltd.

Osprey House, 1 Osprey Court
Hinchingsbrooke Business Park
Huntingdon, Cambridgeshire, PE29 6FN

Phone: +44 1480 411600
E-Mail: info@displaytechnology.co.uk
Internet: www.displaytechnology.co.uk

USA



Apollo Display Technologies, Corp.

87 Raynor Avenue,
Unit 1 Ronkonkoma,
NY 11779

Phone: +1 631 5804360
E-Mail: info@apolloDisplays.com
Internet: www.apolloDisplays.com