

USER MANUAL

POS-PRO series



POS-PRO monitors from
17.8 cm (7") up to 39.6 cm (15.6")

FORTEC
INTEGRATED



Copyright

The contents of this manual are subject to change without notice.

© 2024 FORTEC Integrated. All rights reserved.

Reproduction of this manual in parts or entirely without the previous authorization of FORTEC Integrated is prohibited.

FORTEC Integrated is not liable for errors and collateral or subsequent damage which result from supply, deployment or any other utilisation of this document.

All product names mentioned in this document are trademarks or registered trademarks of their due owners.

Table of Content

1. General specification	4
2. Housing Variants.....	5
3. Scope of delivery	5
4. General Safety Regulations	6
5. First Installation	9
6. Touch Sensors.....	12
7. Mounting optional installation frame.....	13
8. POS-MO-PRO - PME II	14
9. POS-IQ-PRO.....	19
10. POS-VP-PRO.....	22
11. POS-WP-PRO WebPoster	27
12. POS-RP-PRO	29
13. Maintenance.....	32
14. Warranty / Service.....	32
15. Disposal (EU).....	34
16. Declaration of Conformity	35

1. General specification

Scope of Document

These operating instructions are valid for all POS-PRO monitors up to a maximum screen diagonal of 39.6 cm (15.6"). POS-PRO monitors are available in different screen diagonals, with different integrated controllers and additional options. Note: These operating instructions may be supplemented by other documents in which the operation of the various controllers is described in detail. Please refer to the relevant notes. This document and all other referenced documents can be found at:

<https://www.fortec-integrated.de/en/service/downloads/monitore-downloads/>.

POS-PRO Variants:

POS-MO-PRO: Monitor with integrated converter card, 1 x RGB, 1 x HDMI, 1 x Display Port

POS-RP-PRO: Monitor with integrated Raspberry® Pi CM3+ ARM module

POS-VP-PRO: Monitor with integrated network media player for video playlists

POS-WP-PRO: Monitor with WebPoster for interactive media content

POS-IQ-PRO: Monitor with embedded PC type Intel® Pentium® N4200

2. Housing Variants

POS-PRO monitors only differ visually on the back. An installation mounting frame is available as an accessory for each diagonal.

Examples of monitors with mounting frame:

<p>POS-MO-PRO POS-RP-PRO POS-VP-PRO POS-WPPRO</p>		
<p>POS-IQ-PRO</p>		
<p>Installation mounting frame can be ordered as accessories</p>		

3. Scope of delivery

When unpacking the monitor, please check if the following accessories are included in the shipment.



Note: Pictures can differ from actually supplied products.

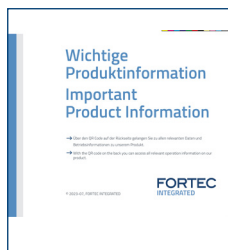

Product information



Adapter for power supply*



Info BIOSpassword*

* only for POS-IQ-PRO

4. General Safety Regulations

Safety information

Please read this safety information carefully for your personal safety and for the prevention of property damage.

In case of a malfunction, immediately disconnect the power plug and contact your dealer or the next Distec GmbH service centre. A malfunction is also considered if the housing, a control element or cable is damaged or if liquids or other objects penetrate the monitor.

Please read the safety information carefully before installing the device. If you have any doubts about whether the device may be used in a particular environment, please contact our service partner.

Repairs

Repairs may only be carried out by authorized technical personnel. Unauthorized access or improper repairs might cause serious property damage or cause danger to the user. In addition to that, any legitimate warranty claim expires.

Electrical connection

Disconnect the monitor from socket before executing any work. Do not touch or connect data cables or power cables during thunderstorms.

System start-up

Before the system start-up let the monitor adjust to the room temperature. Do not expose the device to direct heat sources. In case of condensation, please wait a minimum of 12 hours before switching on the monitor. The monitor shall only be installed and used according to this documentation data sheets. Only qualified personnel may perform the initial installation and system setup.

Qualified personnel

Qualified personnel, in terms of the safety information of this documentation, are persons who are qualified to activate, ground and label devices, systems and circuits according to the safety standards.

Operation

For a proper and safe utilization of the product, adequate transportation, storage, installation, assembly, careful handling and maintenance are essential. The device is only certified for in-door operation. Extreme ambient conditions shall be avoided and the monitor shall be protected from dust, humidity and heat. Do not expose the monitor to direct sunlight.

Transport

Unpack the monitor at the place of installation. Use only original packaging for transportation. Please observe these rules for any later transport.

Condensation

Avoid condensation during transport at low temperatures or at extreme fluctuations of temperature.

Safety guidelines for the handling of LCD monitors



- If the device is not used for a long period of time, unplug the power cable.
- Do not unplug the power cable while the device is powered on, except for emergencies.
- To unplug the device without problems, sockets have to be easily accessible.
- Ensure that the power cable does not get pinched or kinked.
- Do not place heavy objects on the power cable.

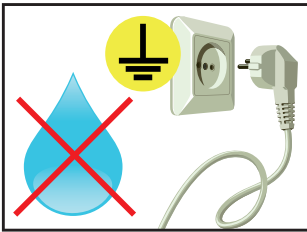

- Do not use damaged or loose sockets to plug in the device.
- Plug the device in earthed sockets only.
- Operate the device with the power cables included in the delivery packet only.
- Use undamaged power cables only.
- When plugging in and out, do not touch the power cable with wet hands.
- Ensure that the power cable is plugged in the socket safely and correctly.
- Use for devices with external power supply only the supplied original power supply, or an equivalent Low Power Source (LPS).

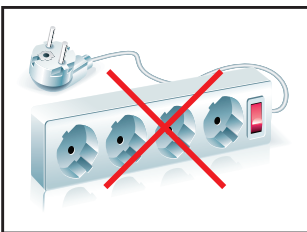

- Do not use extension block to plug several devices into a single socket.



- According to the size, devices may be difficult to handle and very heavy. Ensure that at least two people lift and carry the device.
- Put down the device slowly and carefully to avoid damaging the LCD screen. Ensure that the device stands stable.
- Keep packaging away from children. Danger of suffocation!
- Use our specified and professionally mounted wall mounting only.



- Do not put objects onto the device.
- Do not place candles, heaters or humidifier near the device.
- Keep the device away from fireplaces and flammable materials.

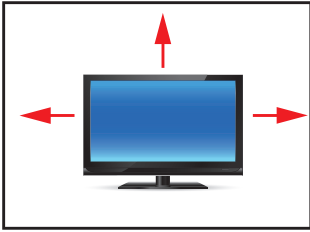

- Ensure sufficient ventilation of the device.
- Keep a minimum distance of at least 10 mm devices to the wall, for devices with integrated PC of at least 40 mm.
- Ensure compliance with the operating temperature.

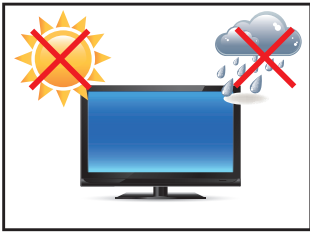

- Do not install the device in places where it is exposed to environmental impacts such as rain or direct sunlight.
- Do not install the device in places where it is exposed to high humidity, dust or smoke. In case of doubt, please contact your sales partner.

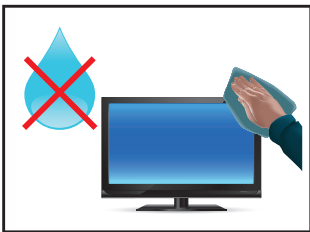

- Please use a soft, moist cloth for cleaning.
- For cleaning the screen, please use only commercially available screen cleaner. Do not spray the cleaner directly to the device but onto a cloth.
- Please clean ventilation slots regularly to ensure a good air circulation.
- Protect your device from water splash.
- When cleaning, please make sure that no liquids get into the device.
- Screens and surfaces can be easily scratched. Therefore, please use the prescribed cloth only.



- Attention! High voltage! Never open the device by yourself.
- In case of unusual noises, burnt smell or smoke unplug the power cable.
- Do not insert objects into the device through the ventilation slots.
- If the same picture is displayed over a longer period of time, an after-image may arise.
- When exchanging batteries of the remote control, pay attention to the polarity. Keep batteries away from children and ensure an environmentally correct disposal.

5. First Installation

Position of connectors and controls

The connection elements for the power supply and data cable are located at the bottom on the back of the monitor. The POS-RP-PRO and POS-MO-PRO series have a keypad for the monitor settings. This keypad is located on the right on the back of the monitor.

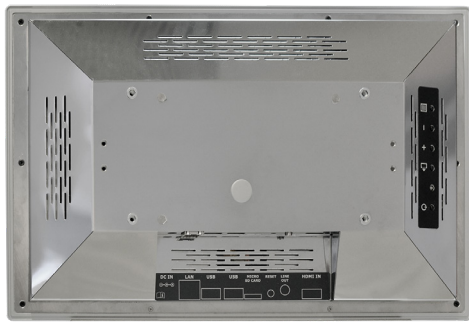

Position of OSD menu for all versions except POS-IQ-PRO



Position of the connection elements for power supply and data cables

Mounting with VESA compatible brackets

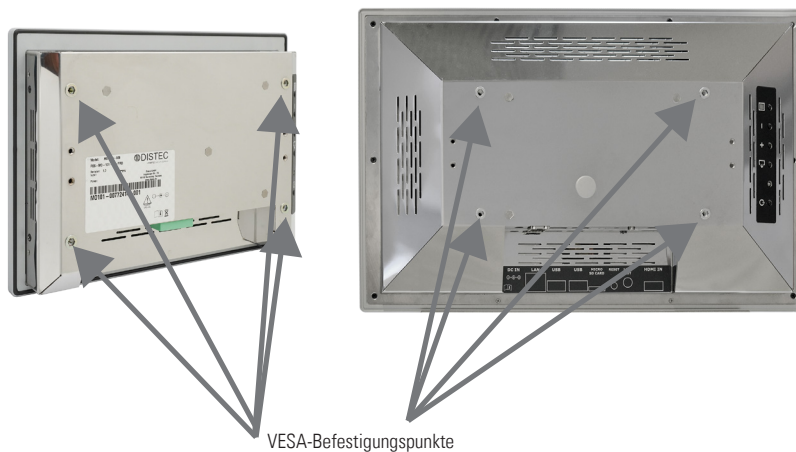

The POS-PRO monitors have an integrated VESA mount.

The operating position of the device is vertical (90° to the floor). The permissible tilt angle must be observed for wall mounting.

The device can be operated both in landscape mode and in portrait mode.

VESA standards:

7.0" VESA 75 x 75

10.1" up to 17.0" VESA 200x100

Mounting

Distance to wall:

- Devices without PC: min. 10 mm
- Devices with PC: min. 40 mm

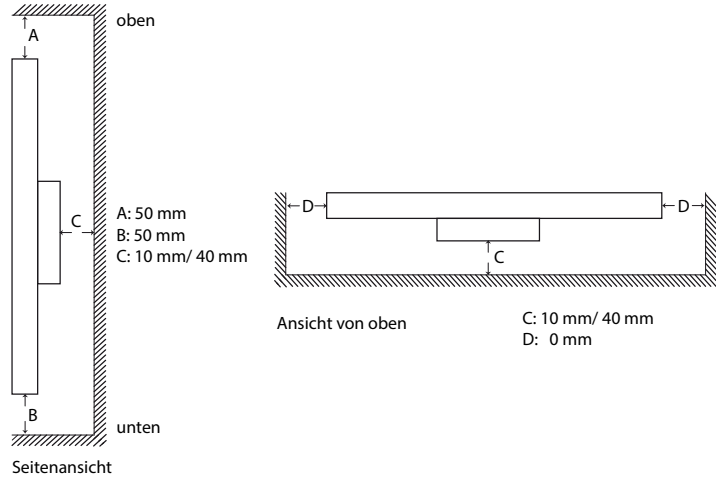

Permitted tilt angle for mounting

The monitors may only be mounted with a tilt angle of 0° - +180°.

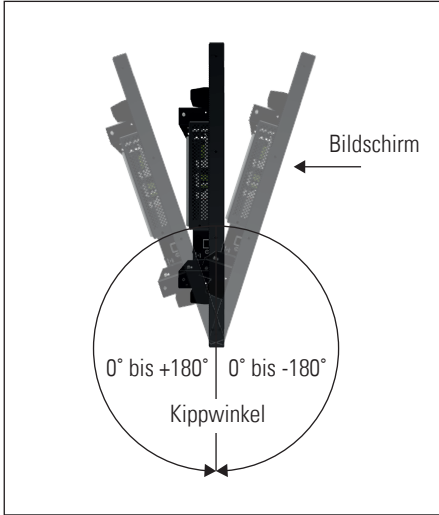

Connecting to power



Note: POS-PRO monitors require different operating voltages depending on the equipment and version. Please observe the information on the correct operating voltage on the type plate before connecting the monitor to a power supply.

Note: POS-PRO monitors can be supplied with a suitable power supply unit from our accessories shop. Please follow the instructions in the section „Connecting the power supply to an existing power source“.

POS-PRO monitors have different operating voltages depending on the equipment or order option. The different configurations can be found in the table below:

Series	Operating voltage			Power supply included in standard
	min.	typ.	max.	
POS-MO-PRO	22.8 V DC	24 V DC	25.2 V DC	no
POS-RP-PRO,/ VP/ WP (12V)	11.4 V DC	12 V DC	12.6 V DC	no
POS-RP-PRO,/ VP/ WP (24V)	22.8 V DC	24 V DC	25.2 V DC	no
POS-IQ-PRO	11.4 V DC	12 - 24 V DC	25.2 V DC	no

Series	Input voltage	Output voltage	Output current	Power
Power supply for POS-PRO series (12V)	100-240 V AC	12V DC	5 A	60 Watt
Power supply for POS-PRO series (24V)	100-240 V AC	24 V DC	3 A	72 Watt

Connecting the power supply with optional power supply unit



Note: Connect all data cables to the respective external devices before connecting the power supply to the monitor.

An adapter cable for connecting the optional power supply unit to the monitor is included with all monitors.

- Plug the adapter cable into the monitor.
- Connect the adapter cable to the 12V cable of the desktop power supply unit.
- Connect the power cable to the desktop power supply unit.
- Plug the power cable into a suitable socket.
- Disconnecting device: The AC desktop power supply can be disconnected via the Phoenix plug (DC) on the POS-Line V2 monitor or via the Schuko plug of the AC power supply.

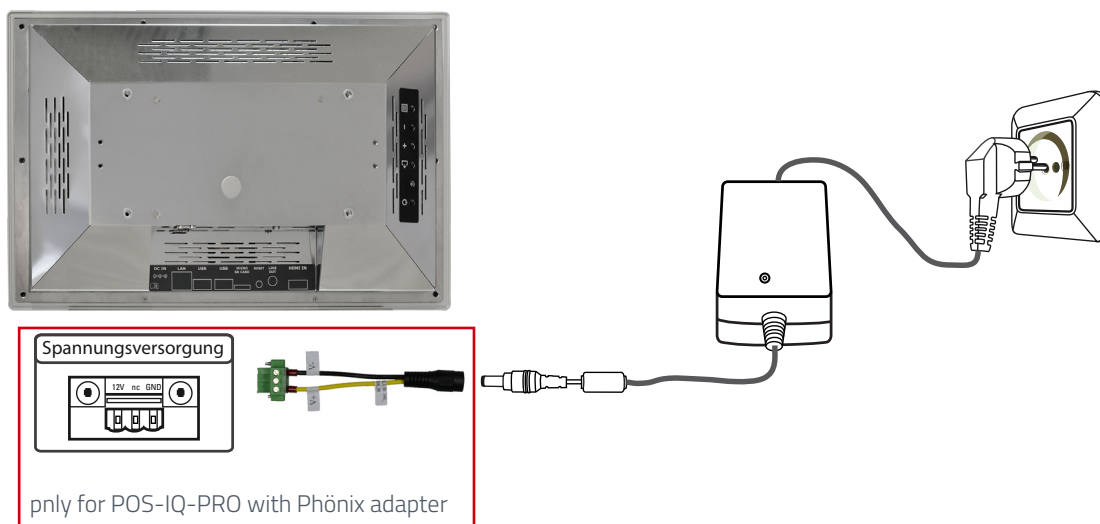

Connecting the power supply to an existing power source

Caution: POS-PRO monitors with an input voltage of 12V or 24V may only be operated with a current source of limited power (see standard EN 62368-1, chapter 2.5, table 2B „Current source limited line“ with max. 12V/8A/ or 24V/4A 100VA).

- Make sure that your power source has sufficient power. Please refer to the rating plate or data sheet for the maximum power consumption of the monitor.
- If necessary, disconnect the adapter cable from the device and the power supply unit.
- Disconnect the green phoenix plug from the adapter cable.



→ Connect the power supply to the Phoenix plug, observing the correct polarity.

→ Phoenix plug, observing the correct polarity.

→ Connect the Phoenix plug to the device.

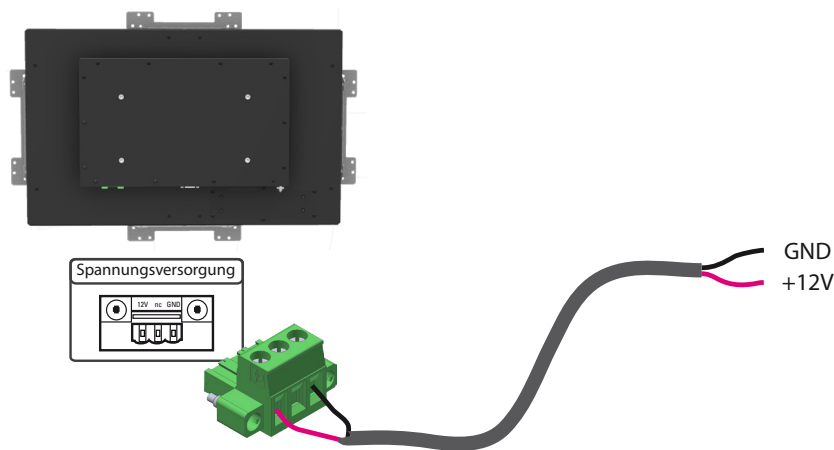

- Disconnecting device: The DC supply network can be disconnected via the Phoenix plug on the POS-Line V2 monitor.

6. Touch Sensors

POS-PRO monitors are equipped with a touch sensor. The PCAP touches used are water, palm and 10-finger compatible. The touch is already mounted at the factory and the drivers are installed.

POS-RP-PRO and POR-IQ-PRO:

The required drivers are already pre-installed in these monitors. The touch can be put into operation immediately.

7. Mounting optional installation frame



Note: POS-PRO monitors can be supplied with a suitable mounting frame from our accessories shop. Below you will find information on the mounting options.

There are two basic options for mounting using the mounting frame:

1. mounting from the front with snap-in bracket
2. mounting from the rear with M4x12 spacer bolts and M4 screws, no snap-in solution

1.

<p>Firstly, the supplied counterparts for the snap-in bracket must be attached to the monitor.</p>	<p>The monitor can then be installed in a wall using a mounting frame</p>	<p>or mount on a panel.</p>

2. Mounting from behind

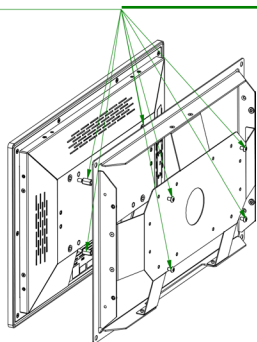

Fixed mounting option from the rear with 4 x M4x12 spacer bolts and M4 screws

Additional mounting options:

via lateral mounting holes with thread

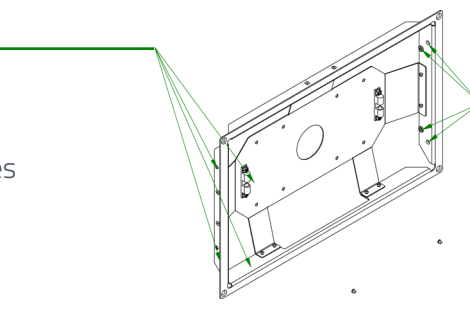

8. POS-MO-PRO - PME II

Connections and OSD Button for POS-MO-PRO

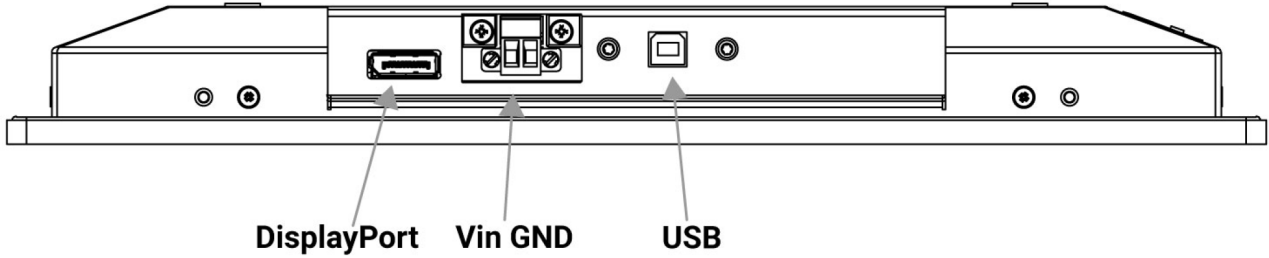

Connecting to PC with DisplayPort cable

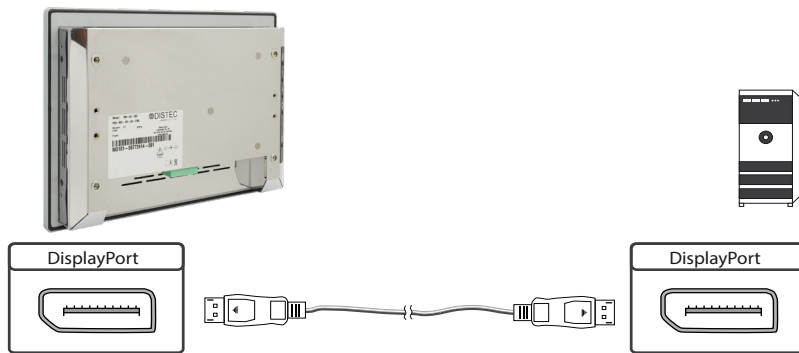

Connecting a touch to PC with USB cable (only for touch monitors)

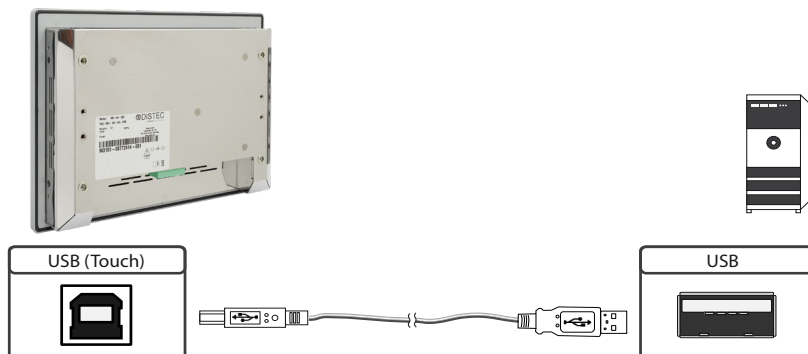

The OSD keyboard

Die OSD-Funktionen des Monitors können Sie über die OSD-Tastatur steuern. Mit dem OSD-Menü können Sie die Signal-Eingangswahl und viele andere Funktionen wie Bildschirmhelligkeit und Kontrast einstellen

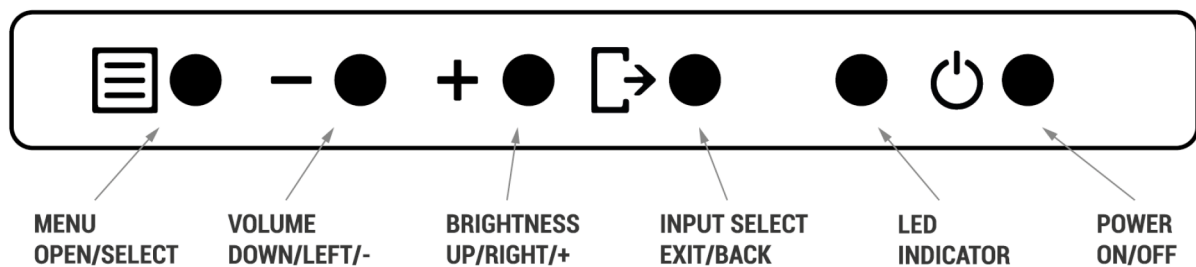

The following two tables give you an overview of the functions:

Direct function selection:

Key	Function	Note
Menu	call up OSD Menu	
—	Call up volume control	
+	Call up brightness control	
Exit	Select signal input	
Power	On/ Off	

Navigation at the OSD Menu:

Taster	Funktion	Bemerkung
Menu	Call up submenu	if at the main menu
	Confirm input	if at the main menu
—	Cursor down	if at the main menu or submenu
	Cursor/ Slider to the left	if at the main menu or submenu
+	Cursor up	if at the main menu or submenu
	Cursor/ Slider to the right	if at the main menu or submenu
Exit	Leave OSD menu	if at the main menu
	Leave submenu	if at the submenu

The red/green LED on the OSD keypad indicates the status of the monitor:

Color	Meaning	Note
Green	Signal found	
Flashing green	Search signal	
Red	Power safe mode	
LED off	Monitor off	

On Screen Menu (OSM)



Menu brightness/ contrast:

Brightness: Adjusts the brightness of the screen
 Contrast: Adjusts the contrast of the screen

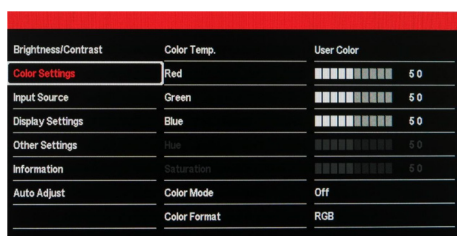

Menu color setting:

Temperature: Selects one of the following predefined or customised user-defined colour temperature schemes: 9300K, 6500K, 5700K, sRGB, User Color
 Red: Gain for the red range, adjustable if user-defined is selected
 Green: Gain for the green range, adjustable if user-defined is selected
 Blue: Gain for the blue range, adjustable if user-defined is selected
 Color tone: Enables adjustment of the colour tone in the UV range, the change affects all colour channels and all input types, only available if the colour space of the of the input is not RGB
 Saturation: Enables the saturation in the UV range to be adjusted range, the change affects all colour channels and all input types, only available if the colour space of the input is not RGB
 Color mode: Not adjustable
 Color format: Selects the RGB or YUV colour format of the input signal. colour format of the input signal

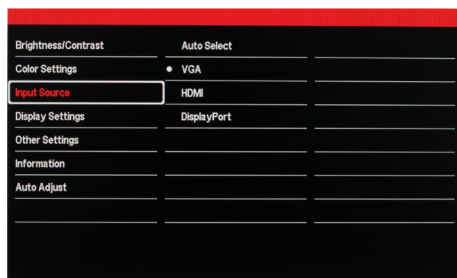

Menu input source:

Input source: Enables manual selection of the input source (auto-select activates/deactivates the automatic detection of the input)



Menu display settings:

- Gamma:** Activates or deactivates the gamma correction of the screen
- H.Position:** Enables horizontal adjustment of the input image (only available for the analogue input)
- V.Position:** Enables the vertical adjustment of the input image (only available for the analogue input)
- Sharpness:** Allows you to adjust the sharpness of the input image (only available for the analogue input)
- Clock:** The slider can be used to set the sample rate of the analogue interface can be set via the slider, supports the improvement of the image quality in non-standard display modes (only available for analogue inputs).
- Section:** The slider can be used to set the sampling phase of the analogue interface can be set via the slider. for optimum image and quality, the input pixels should be sampled at the ideal sampling points (only available for analogue inputs)
- Asperct ratio:** Selects the scaling function for the input signal:
full, 4:3, 16:9, 1:1, KeepInputRatio, OverScan

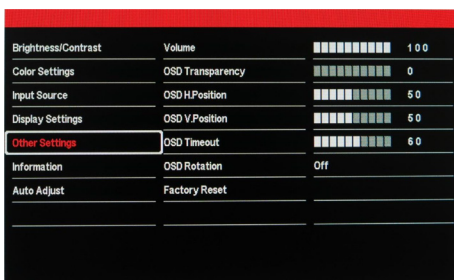

Menu other settings:

- Volume:** Adjusts the volume of the stereo line-out signal of the screen, only available for digital signals and if an audio output is available
- OSD transparency:** Sets the OSD transparency in 6 steps
- OSD H.Position:** Adjusts the horizontal position of the OSD on the screen.
- OSD V.Position:** Adjusts the horizontal position of the OSD on the screen.
- OSD switch off:** Sets the switch-off of the OSD between 10 and 100 seconds. After the selected time of inactivity, the menu is automatically closed
- OSD Alignment:** Selects the orientation of the OSD on the screen between 0°, 180° and 270°
- Factory setting:** Resets all user settings in the OSD to the factory settings.



Menu information:

- Resolution:** Displays the resolution of the current input signal.
- H.Freq:** Displays the mains frequency of the current input signal.
- V.Freq:** Displays the frame rate of the current input signal.
- V.Total:** Displays the number of total lines of the current input signal.

Color format: Displays the selected colour format RGB or YUV colour format.

Fw version: Displays the firmware version of the screen.

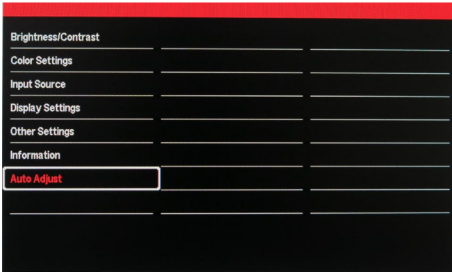

Menu auto adjustment:

Performs the automatic adjustment (only available for analogue inputs)

9. POS-IQ-PRO



Note: The complete driver package for the iBASE mainboard can be found at <https://www.fortec-integrated.de/en/service/downloads/monitor-downloads/>



Note: The device is equipped with a battery. Please observe the following instructions:

- Disconnect the appliance from the power supply before replacing the battery.
- If the battery is not replaced correctly, there is a risk of explosion.
- Always replace the battery with a battery of the same type.
- Take used batteries to your local battery recycling centre. Please also observe the instructions in the „Disposal“ section.

Passive Cooling

POS-IQ-PRO series monitors are equipped with passive cooling.

Passively cooled monitors dissipate the heat from the processor to the monitor housing. Passively cooled devices have no moving parts.

PC Spezifikation

Please refer to the current data sheet for details on the PC specification of the POS-IQ-PRO.

POS-IQ-PRO monitors of series IQ iBASE have following connections and operation elements

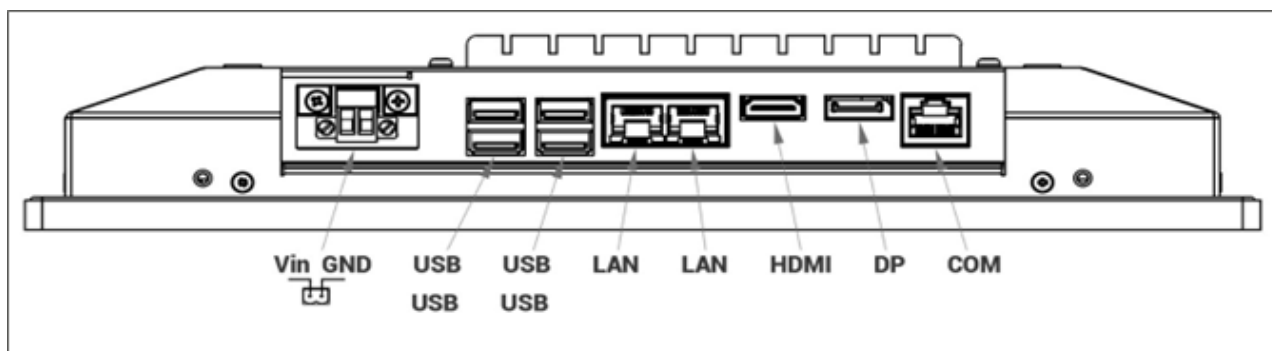

LED display

- Upper LED lights up yellow - HDD active
- Lower LED lights up green - device has power

Connecting to network with patch-cable

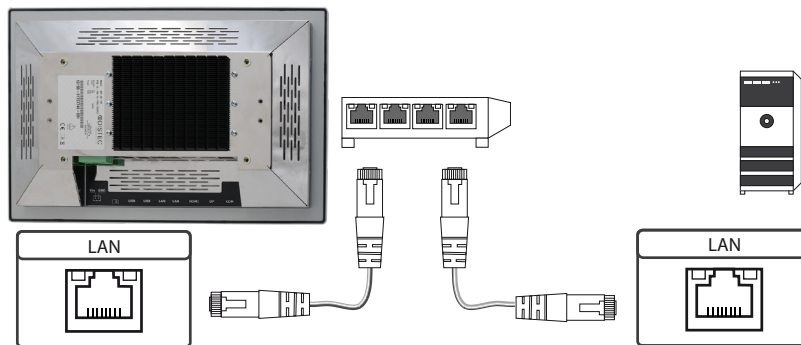

Connecting to PC with cross-over network cable

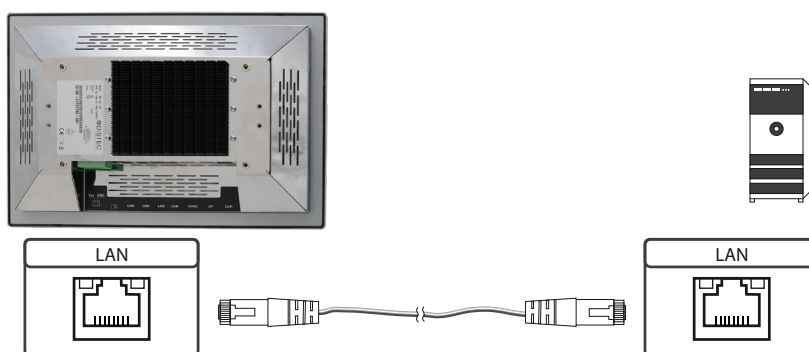

Connecting to keyboard and mouse via USB cable

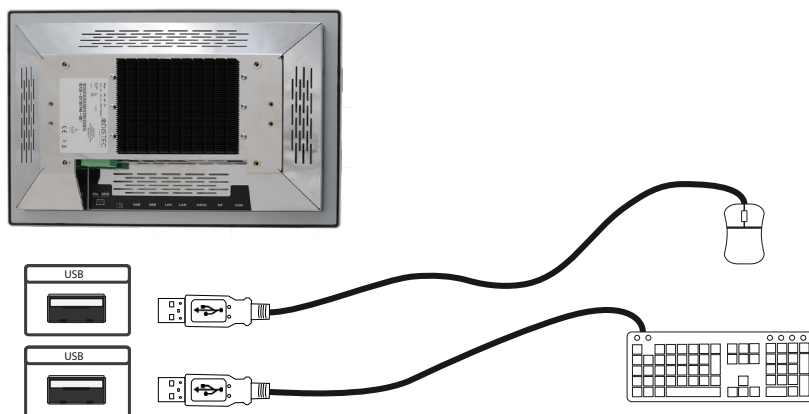

Connecting of a monitor with HDMI cable

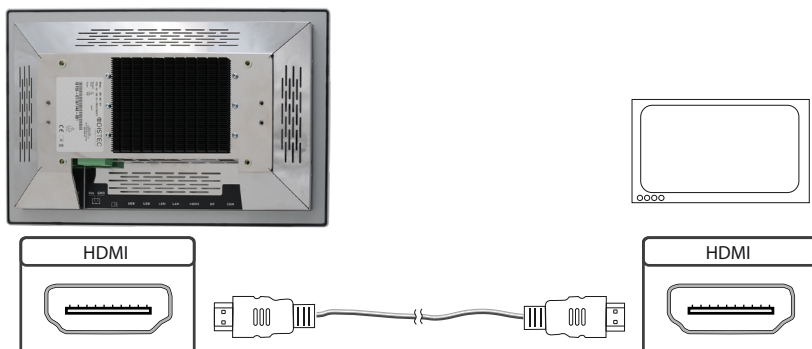

Connecting PC with DisplayPort cable

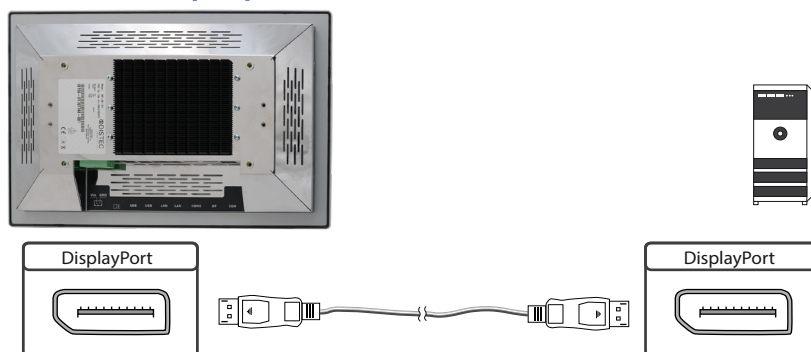

Switching on and off

The PC starts automatically when the supply voltage is applied.

Calling up the BIOS settings

The Integrated iBASE PC is equipped with a BIOS from American Megatrends Inc (AMI BIOS). When switching on the PC, press the .DEL' or .Del' key on the keyboard to access the BIOS.

The BIOS is secured with a password. You will receive the password in the device box on delivery.

Operating systems

If you have ordered the POS-IQ-PRO with the Windows operating system option, the operating system you have ordered is already pre-installed. All necessary drivers have also been installed.

A distinction is made when activating the operating system:

- Windows 10 IOT: The operating system is already activated. The licence key is stuck to the monitor.
- Windows 10 PRO: The operating system is not activated. The licence key is enclosed. When you switch on the device for the first time, you will be prompted to enter the licence key.

10. POS-VP-PRO



Note: Detailed information on the media player, the playlist structure, general operation and use as well as software components for setting up and programming can be found at: <https://www.fortec-integrated.de/en/products/tft-components/tft-controller/iot-media-player/>



Note: The device is equipped with a battery. Please note the following information:

- Disconnect the appliance from the power supply before replacing the battery.
- If the battery is not replaced correctly, there is a risk of explosion.
- Always replace the battery with a battery of the same type.
- Take used batteries to your local battery recycling centre. Please also observe the instructions in the „Disposal“ chapter.

POS-VP-PRO have the following connectors and controls

POS-VP-PRO, POS-WP-PRO und POS-RP-PRO have the same hardware equipment.

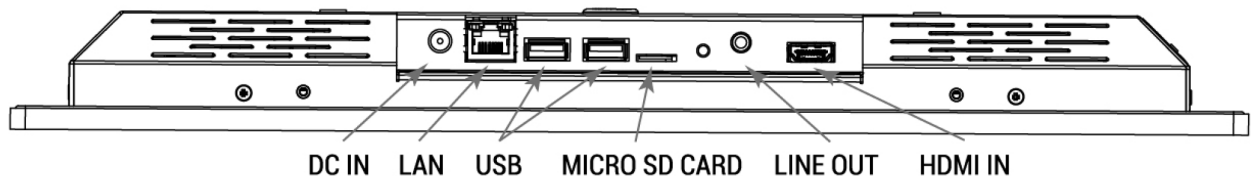

Connecting to network with patch cable

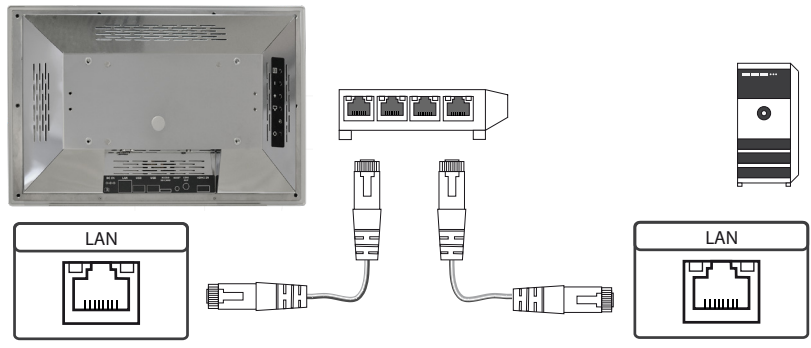

Connecting to PC with cross-over network cable

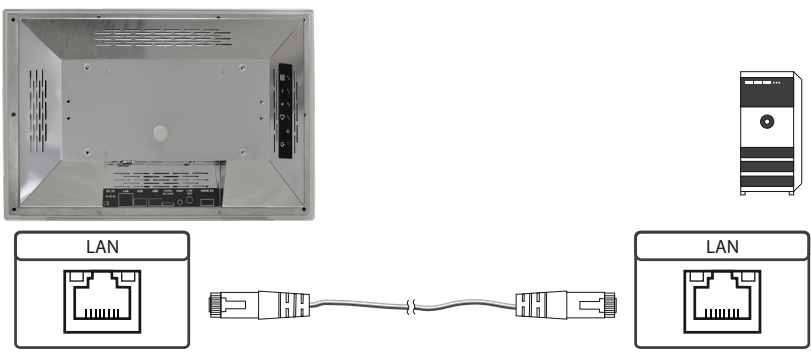

Connecting USB stick



Connecting active speakers

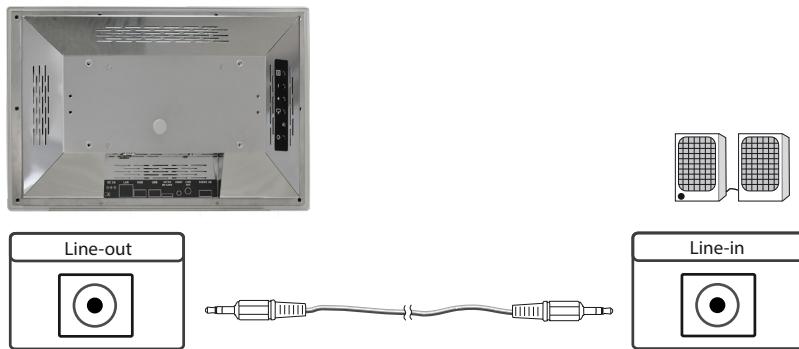

Connecting an external player with HDMI cable

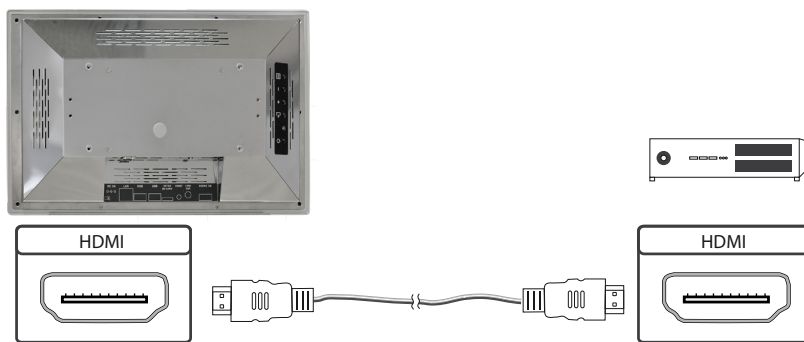

Connecting an external player with HDMI-DVI cable

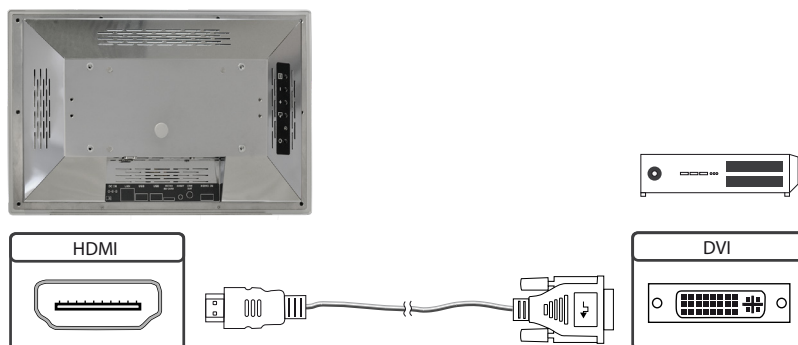

Configuration of the media player on delivery (factory configuration)

This device is a LAN (Ethernet)-capable device. Please note that an incorrect network configuration of the device can impair the secure operation of the entire network and, in the worst case, lead to a network failure. To set up the device for a specific network, you must be familiar with the main operating parameters of the network.

POS-Line VideoPosters are supplied from the factory with the following configuration:

- DHCP: on
- IP address: Assigned by the DHCP server (static IP address 192.168.0.1 if there is no DHCP server in the network)
- Netmask: Assigned by the DHCP server (255.255.255.0 if there is no DHCP server in the network)
- Hostname: VideoPoster-IV-xx-xx-xx (the last 6 bytes of the MAC address of the device)
- Login name: Artista
- Password: Artista
- Content auto update: off

MicroSD card

The media player stores its playlists on the internal 32 GB memory. However, this can be expanded using a microSD card if the internal memory is not sufficient. If a microSD card is inserted, it must not be removed during operation!

Supported media formats

Video:

- MPEG-4 AVC / H.264
- Quicktime
- Flash Video
- MPEG Transport Stream

Bilder:

- PNG
- JPG
- BMP

General function description

The network-compatible media player is a complete solution for playing playlists. The playlists are based on an XML structure and can contain images and videos. The media player is controlled entirely via the playlist; a loaded playlist is played in an endless loop. A playlist can contain several sub-playlists, each of which is time-controlled or called up by an external trigger event.

The media player does not need to be „operated“. As soon as a playlist has been fully loaded, it is played automatically. The device can be disconnected from the power supply at any time. When it is switched on again, the last loaded playlist is started automatically.

Priority-controlled external feed

An external playback device, e.g. a BlueRay player, can be connected to the HDMI interface of the media player. The playback control can be set up so that playback of the playlist is stopped as soon as an HDMI signal is recognised. In this case, the signal received via HDMI is played back. If the HDMI signal is switched off, the player automatically starts playing the saved playlist.

Software

You have been provided with the following software and the associated documentation by e-mail:

ACC: A programme that runs under Windows for easy creation of playlists, for transferring playlists to the media player, for saving playlists on a USB stick (for manual transfer) and for monitoring the operation of the media players.

ADF: A programme that simplifies the installation and configuration of media players. Connect all media players in the factory configuration to the network and start ADF. All media players are displayed in a list. Select the devices one after the other and carry out the network configuration.

Load playlists

There are basically four possible methods for loading playlists:

Via USB: If a USB stick with a playlist is inserted into the media player, it is automatically loaded and started. A network connection is not necessary in this operating mode.

Via ACC: This Windows software included in the scope of delivery creates the playlists and offers functions for transferring the playlists directly to one or more media players via the network.

Via FTP server: The media player connects to an FTP server at configurable time intervals and searches for a new playlist. The difference between the existing and new playlist is automatically reloaded and the new playlist is started.

Via HTTP protocol: Playlists can be transferred from a content management system to the media player via the network using the HTTP protocol.

Configuration of media player

The media player can be configured using any standard Internet browser (Firefox, Internet Explorer, Chrome, etc.). To do this, connect the media player to a network and enter the URL (e.g. IP address or network name) in the browser to establish the connection. The WEB interface will now open. If you are asked for the password, enter the password (factory setting: Login name: Artista; Password: Artista).

The web interface is divided into three areas with the respective pages:

Information

System information: This page contains all the details about the system, such as the software version. When contacting our support team, please attach this page to your e-mail to ensure quick processing.

View logs: The operation of the media players can be monitored with log files. There are

different log files for monitoring the respective subsystems:

- Player** - shows the log file of the video player and error messages
- Updater** - shows the log file of the content updates and error messages
- Setup Manager** - shows which setup files have been executed
- Event Manager** - displays error messages from the Event Manager

Configuration

- Network configuration: Configuring the network is the first step in the setup process. With „Submit Configuration“ the entries are accepted. With „Discard Changes“ entries in the fields are deleted, but this has no effect on the current configuration.
- Date and time: Set the time zone, date and time here. The time can be automatically synchronised with a network server (NTP).
- Content auto update: Enter the access data for an FTP server here if you want the media player to automatically should load its playlists from an FTP server.
- Audio settings: You can set the volume for external speakers here.
- Display settings: You can set the display brightness here.
- HTTP Access: You can assign a new password here. It is recommended to change the password after installation.
- Advanced: On this page, you can update the firmware, reformat the microSD card (optional), reset the module to the factory settings with a master reset and factory settings with a master reset and enable the priority-controlled HDMI input.

Restart

- Restart: Restart of media player.

Advertisement of IP address and host name

When the media player boots up, the current IP address and the host name of the media player are displayed on the screen for approx. 5 seconds.

11. POS-WP-PRO WebPoster

Connections and controls

WebPosters are POS-RP-PRO devices with a special firmware, therefore the connections and operating elements in the corresponding section must be observed. Connecting a mouse and keyboard is not supported with this firmware.

General function description

The Industrial Full HD HTML Player is a complete solution for displaying websites. The web pages can be configured via a web interface. An automatic display takes place when the device is started.

Configuration of the media player on delivery (factory configuration)

This device is a LAN (Ethernet)-capable device. Please note that an incorrect network configuration of the device can impair the secure operation of the entire network and, in the worst case, lead to a network failure. To set up the device for a specific network, you must be familiar with the main operating parameters of the network. The POS-Line WebPoster is delivered from the factory with the following configuration:

- DHCP: on
- IP address: 192.168.0.1*
- Net mask: 255.255.255.0
- Host name: WebPoster-xx-xx-xx (the last 6 bytes of the MAC address of the device)
- Login name: Artista
- Pass word: Artista

*If no DHCP server is found, this IP address is automatically assigned.

Supported website formats

- HTML5
- JavaScript

Software

You can find software and the corresponding documentation on our website: <https://www.distec.de/en/service/downloads/webposter-downloads/>.

ADF: A programme that simplifies the installation and configuration of HTML players. Connect all HTML players in the factory configuration to the network and start ADF. All HTML players are displayed in a list. Select the devices one after the other and carry out the network configuration.

Configuration of media player

The HTML player can be configured using any standard Internet browser (Firefox, Internet Explorer, Chrome, etc.). To do this, connect the HTML player to a network and enter the URL (e.g. IP address or network name) in the browser to establish the connection. The WEB interface will now open. If you are asked for the password, enter the password (factory setting: Login name: Artista; Password: Artista).

The web interface is divided into three areas with the respective pages:

Configuration

Network configuration: Configuring the network is the first step in the setup process.

Submit configuration: The entries are accepted with Submit Configuration.

Discard changes: Discard Changes deletes entries in the fields.
However, this has no effect on the current configuration.

Browser settings: The configuration of the website to be displayed is the second step of the setup. The website can be entered here and a „Reload Interval (seconds)“ can be defined.

Submit configuration: The entries are accepted with Submit Configuration.

Discard changes: Discard Changes deletes entries in the fields.

Change password: The factory-set password can be changed here.

Information

System Information: This page contains all the details about the system, such as the software version. When contacting our support team, please attach this page to your e-mail, to ensure fast processing.

Restart

Restart: Restart of media player.

Advertisement of IP address and host name

When the HTML player boots up, the current IP address and the host name of the HTML player are displayed on the screen for approx. 5 seconds.

12. POS-RP-PRO

The POS-RP-PRO monitor is equipped with the Raspberry® Pi Compute Module 3+ (CM3+). Its specification can be found under the following link:

<https://www.raspberrypi.org/products/compute-module-3-plus/>



Note:

The complete driver package for the POS-RP-PRO monitor can be found at <https://www.fortec-integrated.de/service/en/downloads/monitor-downloads/>.

The device is equipped with a battery. Please note the following information:

- Disconnect the appliance from the power supply before replacing the battery.
- If the battery is not replaced correctly, there is a risk of explosion.
- Always replace the battery with a battery of the same type.
- Take used batteries to your local battery recycling centre. Please also observe the instructions in the „Disposal“ chapter

Passive Cooling

POS-RP-PRO monitors are equipped with passive cooling. Passively cooled monitors dissipate the heat from the processor to the monitor housing. Passively cooled devices have no moving parts.

Spezification

Please refer to the current data sheet for details on the specification of the POS-RP-PRO monitor.

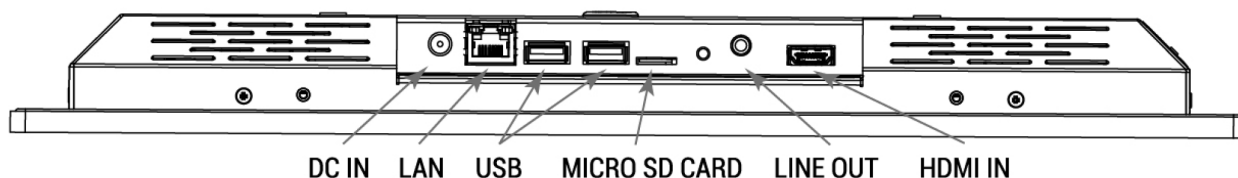

Connecting to network with patch cable

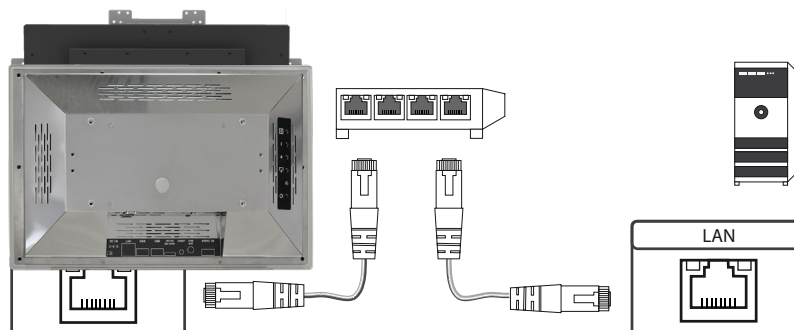

Connecting to PC with cross over network cable

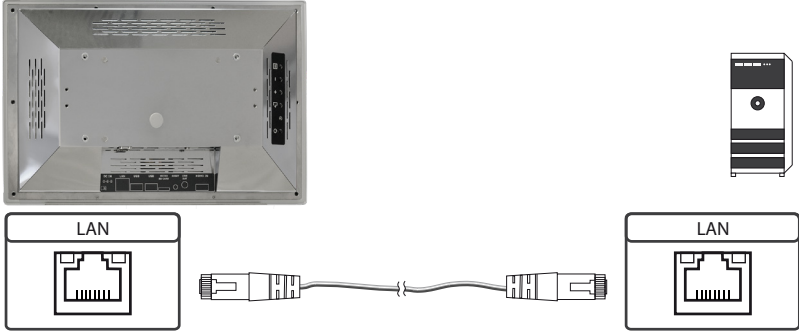

Connecting USB stick



Connecting active speakers

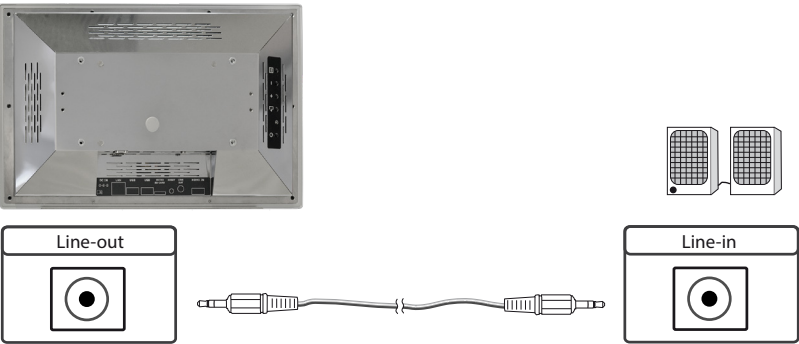

Connecting an external playback device with HDMI cable

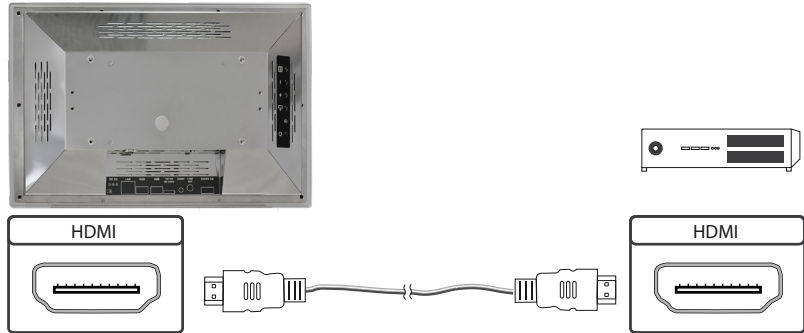

Connecting an external playback device with HDMI-DVI cable

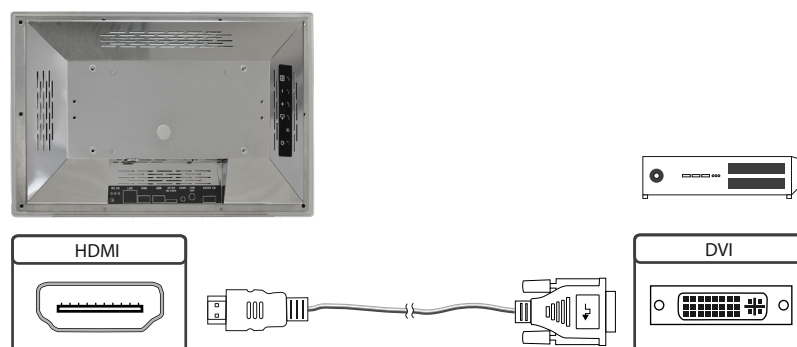

Switch On or Off

The POS-RP-PRO monitor starts automatically when the supply voltage is applied. To switch off, „Shut down“ must be selected in the operating system.

Operation systems

The POS-RP-PRO Monitor is supplied with the Raspbian operating system, which is equipped with all the necessary drivers. This operating system is the official version of the community, reduced to the internal memory of the compute module. It is only used for the initial commissioning of the monitors. The POS-RP-PRO monitor can be equipped and programmed with its own operating system/image by the customer. The USB port on the back of the monitor, which is located under the cover, can be used for this purpose (see arrow).



You will find a guide for integrating an image on our homepage at:

<https://www.fortec-integrated.de/en/products/tft-components/tft-controller/iot-media-player/>

In the Raspberry® Pi community (<https://www.raspberrypi.org/forums/>) you can find many solutions to problems and help with integrating and creating your own system.

13. Maintenance

For devices with active cooling, the ventilation slots of the housing must be cleaned every 6 months to ensure sufficient air circulation. For devices with passive cooling, the ventilation slots must be checked every 12 months and cleaned if necessary.

14. Warranty / Service

Warranty

FORTEC GROUP grants a manufacturer's warranty of two years from the date of delivery.

The rendering of warranty claims shall neither extend nor restart the warranty period.

During the warranty period, FORTEC GROUP shall repair product faults based on material or production defects. The warranty service is executed at FORTEC GROUP's discretion through repair, replacement of defective parts or by exchanging a product for a product of equal quality without charging the customer for material or labor.

Warranty claims are only accepted, if FORTEC GROUP receives notification of a defective product within the warranty period and the product is presented to the FORTEC GROUP Service Centre together with all information as specified in the RMA process.

Warranty Exclusions and Limitations

This warranty does not apply to any defect for which FORTEC GROUP is not responsible and which includes, but is not limited to the following:

- Unauthorized opening or disassembling of the product
- Faulty maintenance by non-observation of maintenance instructions
- Inappropriate storage or cleaning of the product
- Unauthorized modification of the product
- Incorrect use or misuse
- Non-observation of operating and installation instructions
- Permanent display of fixed images (causing image retention or image sticking)
- Operating the product in conditions which exceed the limitations of the specification
- Use of inappropriate boxes, packaging or modes of shipment
- Force majeure like fire, acts of war, acts of violence, chemical or biological impacts, lightning strikes, over voltage or similar events
- Fault resulting from the use of software which was not originally supplied with the product or which is incorrectly installed
- Normal wear and tear and wearing parts (i.e. LCD panel)

Mechanical damages like scratches, pressure or break points are excluded from this warranty.

This warranty does not include accessory parts which are not integral part of the product (as boxes, batteries).

Pixel errors only constitute a fault under the terms of this warranty if they deviate from the product specification (i.e. ISO 9241-307 pixel failure class II).

Display Quality - Prevention of after image burn in effects

After image burn-in means that an image or part of an image (i.e. logo) remains visible on the screen even if the image on the screen is changed. This should not occur if the LCD panel is operated in normal conditions with changing content. To prevent burn-in effects please follow the following guidelines.

- Power-off the monitor for 2 hours after using it for 18 hours.
- Use the power scheme and power management of the PC.
- Use plain-colored screen savers.
- Avoid patterns with a strong difference in brightness and contrast.
- Avoid gray colors.
- Change images and logos regularly. Show animated pictures for 60 seconds after 4 hours of operation.
- The best way to protect your display is to switch the monitor off when not in use or to use screen savers.

Non-observance of these guidelines may have effects on warranty.

Warranty Processing

FORTEC GROUP RMA process. In order to avoid unnecessary charges, it is important to adhere to the RMA regulations.

Products must be appropriately and professionally packed for a safe return to the FORTEC GROUP Service Centre. Products with panel sizes equal or larger than 81 cm (32") must be shipped on pallets in upright position.

FORTEC GROUP does not assume liability for any customer data stored on products which are returned to FORTEC GROUP.

Limitations of Liability and Benefits

With this warranty declaration, FORTEC GROUP exclusively warrantys that the product is free of material and manufacturing faults.

FORTEC GROUP does not issue any other warranty or similar statements other than this declaration.

This warranty does not impair or affect a buyer's statutory claim against the seller due to material damage. Such claims can be asserted instead of the warranty agreed to here at the buyer's discretion.

Mandatory legal rights and mandatory claims under the German product liability remain unaffected.

Applicable Law and Place of Jurisdiction

The laws of the Federal Republic of Germany apply.

Place of jurisdiction is Munich.

Service addresses

Germany

FORTEC Integrated GmbH
Augsburger Straße 2b
82110 Germering
Tel: +49 89 894363-0
Mail: rma@fortec-integrated.de

Great Britain

FORTEC Technology UK Ltd.
Osprey House, 1 Sprey Court
Hichingbrooke Business Park
Huntingdon, Cambridgeshire
PE29 6FN Tel +44 14 80 41 16 00
Mail: info@fortec.uk

USA

Apollo Corp.
87 Raynor Avenue, Unit 1
Ronkonkoma NY 11779
Tel +1 63 15 80-43 60
Mail: info@apolloDisplays.com

Please go to the following web address for further information about our RMA regulations and RMA forms:

<https://www.fortec-integrated.de/en/service/return-rma/>

15. Disposal (EU)

Disposal of old devices

If the acquired FORTEC Integrated product is to be disposed of, must be implemented into national law the Directive 2012/19/EU.

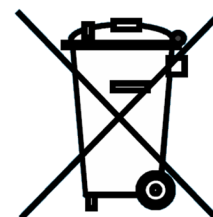

Disposal of batteries

Applicable in all countries of the EU and in countries with separate battery collection systems.

The Batteries in this product should not be disposed with other household waste. The chemical symbol Pb, CD or Hg indicate that the battery contains lead, cadmium or mercury above the reference level in EC directive 2019/19/EG.

Batteries which are not disposed correctly can cause harm environment and health.

Our environment is close to our hearts. Please help us to protect our environment and recycle empty batteries with the free battery collection system.

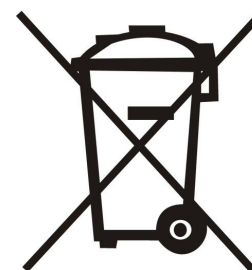

16. Declaration of Conformity

Declaration

Hereby the FORTEC Integrated GmbH declared that the unit EU is in compliance with the essential requirements and other relevant provisions of Directives 2014/30/EU and 2014/35/EU and 2011/65/EU.

If you require a CE declaration of conformity, please request this from the support team on our website: <https://www.fortec-integrated.de/en/service/technical-support/>

FCC-Declaration of conformity

This equipment has been tested and found to comply with the limits for a Class A digital device, pursuant to Part 15 of the FCC Rules.

These limits are designed to provide reasonable protection against harmful interference when the equipment is operated in a commercial environment. This equipment generates, uses and can radiate radio frequency energy and, if not installed and used in accordance with the instruction manual, may cause harmful interference to radio communications.

Operation of this equipment in a residential area is likely to cause harmful interference in which case the user will be required to correct the interference at his own expense.

Canadian Department of Communications Compliance Statement

This Class A digital apparatus meets all requirements of the Canadian Interference-Causing Equipment Regulations.

Observation des normes-Class A - Cet appareil numérique de la classe B est conforme à la norme NMB-003 du Canada.

FCC Information:

- Changes or modifications not expressly approved by the party responsible for compliance could void the user's authority to operate the equipment. If the device is supplied with shielded connecting cables or if special accessories have been specified for use with the product installation, these must be used to maintain compliance with FCC regulations.
- Use the attached or supplied cables to avoid interference with radio or television reception.
- Please use the supplied power cord or equivalent to ensure FCC compliance.
- Please use the supplied shielded video signal cable, mini D-SUB 15-pin to mini D-SUB 15-pin.