



OUR GLOBAL
COMPETENCE
CENTRES

 APOLLO DISPLAY
TECHNOLOGIES



 DISTEC



 DISPLAY
TECHNOLOGY



Datasheet

Disea

NK !H\$) \$EK <!\$'

ÖÖÉí ÈÈí



PRODUCT SPECIFICATIONS

For Customer: _____

: APPROVAL FOR SPECIFICATION

Customer Model No. _____

: APPROVAL FOR SAMPLE

Module No.: ZW-T050QWH-03

Date : 2015-06-01

Table of Contents

No.	Item	Page
1	Cover Sheet(Table of Contents)	
2	Revision Record	
3	General Specifications	
4	Outline Drawing	
5	Absolute Maximum Ratings	
6	Electrical Specifications	
7	Optical Characteristics	
8	Reliability Test Items and Criteria	
9	Precautions for Use of LCD Modules	

For Customer's Acceptance:

Approved By	Comment

PREPARED	CHECKED	VERIFIED BY QA DEPT	VERIFIED BY R&D DEPT
GZH	JOHN		Dmjjiang

3. General Specifications

ZW-T050QWUH-03 is a TFT-LCD module. It is composed of a TFT-LCD panel, driver IC, FPC, a backlight unit. The 5.0" display area contains 800X480 pixels and can display up to 16.7M colors. This product accords with RoHS environmental criterion.

Item	Contents	Unit	Note
LCD Type	TFT/Transmissive/Normally white	-	
Display color	16.7M		
Viewing Direction	12:00	O'Clock	
Gray scale inversion direction	6:00	O'Clock	
Operating temperature	-20~+70	°C	
Storage temperature	-30~+80	°C	
Module size	120.7x75.8x4.3	mm	
Active Area(W×H)	108.00X64.80	mm	
Number of Dots	800×480	dots	
Controller	ILI6122+ILI5960	-	
Power Supply Voltage	3.3	V	
Backlight	18-LEDs (white)	pcs	
Weight	---	g	
Interface	RGB888	-	

Note 1: Color tune is slightly changed by temperature and driving voltage.

Note 2: Without FPC and Solder.

4.Outline Drawing

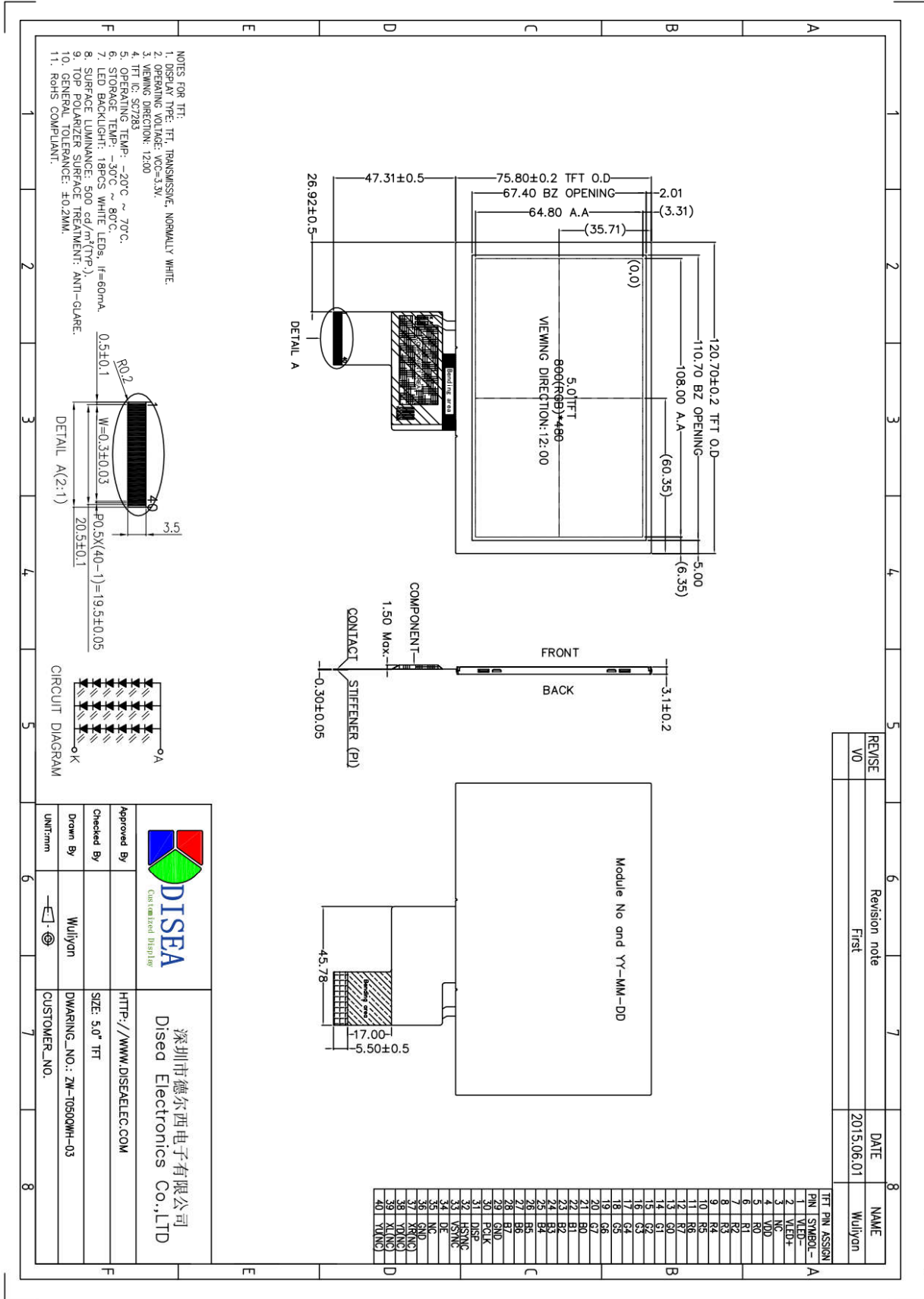

REVISE	Revision note	DATE	NAME
V0	First	2015.06.01	Muliyon

		深圳市德尔西电子有限公司 Disea Electronics Co.,LTD	
Approved By		HTTP://WWW.DISEALEC.COM	
Checked By		SIZE: 5.0" TFT	
Drawn By	Muliyon	DWARING_NO.: ZW-10500WH-03	
UNIT:mm		CUSTOMER_NO.	

5. Absolute Maximum Ratings(Ta=25°C)

5.1 Electrical Absolute Maximum Ratings.(Vss=0V ,Ta=25°C)

Item	Symbol	Min.	Max.	Unit	Note
Power Supply Voltage	V _{DD}	-0.3	4.0	V	1, 2

Notes:

1. If the module is above these absolute maximum ratings. It may become permanently damaged. Using the module within the following electrical characteristic conditions are also exceeded, the module will malfunction and cause poor reliability.
2. V_{DD} > V_{SS} must be maintained.
3. Please be sure users are grounded when handing LCD Module

5.2 Environmental Absolute Maximum Ratings.

Item	Storage		Operating		Note
	MIN.	MAX.	MIN.	MAX.	
Ambient Temperature	-30°C	80°C	-20°C	70°C	1,2
Humidity	-	-	-	-	3

1. The response time will become lower when operated at low temperature.
2. Background color changes slightly depending on ambient temperature.
The phenomenon is reversible.
3. Ta<=40°C:90%RH MAX.
Ta>=40°C:Absolute humidity must be lower than the humidity of 90%RH at 40°C.

6. Electrical Specifications

6.1 Electrical characteristics(V_{SS}=0V ,T_a=25°C)

Parameter		Symbol	Condition	Min	Typ	Max	Unit	Note
Power supply		VDD	T _a =25°C	3.0	3.3	3.6	V	
Input voltage	'H'	V _{IH}	V _{DD} =3.3V	0.7V _{DD}	-	V _{DD}	V	
	'L'	V _{IL}	V _{DD} =3.3V	0	-	0.3V _{DD}	V	
Current Consumption		I _{DD1}	Normal mode	-	90	110	mA	1
		I _{DD2}	Sleep mode	-	0.05	0.1	mA	1
Clock Frequency		f _{CLK}	-	-	20	30	MHz	

Note:

1: Tested in 1×1 chessboard pattern.

6.2 LED backlight specification(V_{SS}=0V ,T_a=25°C)

Item	Symbol	Condition	Min	Typ	Max	Unit	Note
Supply voltage	V _f	I _f =60mA	16.5	18.0	20.0	V	
Uniformity	Δ Bp	I _f =60mA	75	-	-	%	
LED life time	-	I _f =60mA	30k	50k	-	Hours	

Note:

1 : The"LED Life time" is defined as the module brightnees decrease to 50% original brightness at T=25°C and I_{LED} =40mA. The LED Life time could be decreased if operating I_{LED} is larger than 40mA

6.3 Interface signals

Pin No.	Symbol	I/O	Function
1	LEDK	P	LED power cathode
2	LEDA	P	LED power anode
3	NC	I	No connection
4	VDD	P	System power
5-12	R0-R7	I	Red data bus
13-20	G0-G7	I	Green data bus
21-28	B0-B7	I	Blue data bus
29	GND	P	Ground
30	CLK	I	pixel clock input pin
31	DISP	I	DISP sets the display mode. L :Standby mode H :Normal display mode
32	HSYNC	I	Horizontal sync input
33	VSYNC	I	Vertical sync input
34	DE	I	Data enable pin
35	NC	I	No connection
36	GND	I	Ground
37	XR	O	Touch panel control pin
38	YD	O	
39	XL	O	
40	YU	O	

6.4 Timing Table

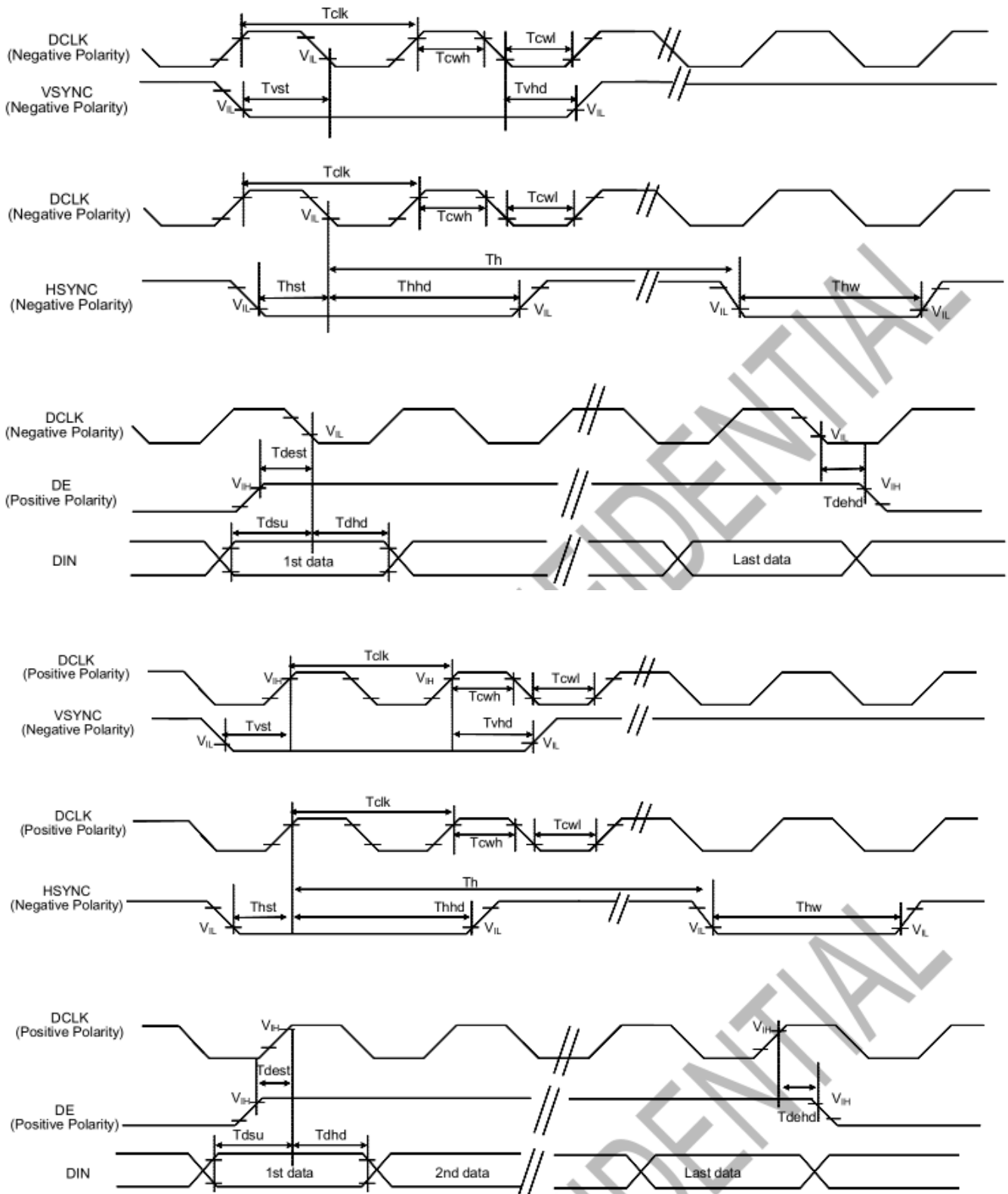

Item	Symbol	Min.	Typ.	Max.	Unit	Conditions
CLK Pulse Duty	Tcw	40	50	60	%	
HSYNC Width	Thw	2	-	-	DCLK	
HSYNC Period	Th	55	60	65	us	
VSYNC Setup Time	Tvst	12	-	-	ns	
VSYNC Hold Time	Tvhd	12	-	-	ns	
HSYNC Setup Time	Thst	12	-	-	ns	
HSYNC Hold Time	Thhd	12	-	-	ns	
Data Setup Time	Tdsu	12	-	-	ns	
Data Hold Time	Tdhd	12	-	-	ns	
DE Setup Time	Tdest	12	-	-	ns	
DE Hold Time	Tdehd	12	-	-	ns	

Parallel 24-bit RGB Input Timing (PVDD=VDD=VDDI= 3.3V, AGND= 0V, TA=25°C)

Parallel 24-bit RGB Interface Timing Table						
Item	Symbol	Min.	Typ.	Max.	Unit	Remark
DCLK Frequency	Fclk	23	25	27	MHz	
HSYNC	Period Time	Th	808	816	896	DCLK
	Display Period	Thdisp	800			DCLK
	Back Porch	Thbp	4	8	48	DCLK
	Front Porch	Thfp	4	8	48	DCLK
	Pulse Width	Thw	2	4	8	DCLK
VSYNC	Period Time	Tv	488	496	504	HSYNC
	Display Period	Tvdisp	480			HSYNC
	Back Porch	Tvbp	4	8	12	HSYNC
	Front Porch	Tvfp	4	8	12	HSYNC
	Pulse Width	Tvw	2	4	8	HSYNC

7. Optical Characteristics

Item	Symbol	Condition	Min.	Typ.	Max.	Unit	Note
Brightness (With TP)	Bp	$\theta=0^\circ$ $\Phi=0^\circ$	400	500	-	Cd/m ²	1
Uniformity	$\triangle Bp$		75	-	-	%	1,2
Viewing Angle	3:00	Cr \geq 10	50	60	-	Deg	3
	6:00		35	45	-		
	9:00		50	60	-		
	12:00		50	60	-		
Contrast Ratio	Cr	$\theta=0^\circ$ $\Phi=0^\circ$	300	500	-	-	4
Response Time	T _r		-	10	-	ms	5
	T _f		-	10	-	ms	
Color of CIE Coordinate	W	x	-0.05	0.28	+0.05	-	1,6
		y		0.33		-	
	R	x		0.51		-	
		y		0.34		-	
	G	x		0.31		-	
		y		0.56		-	
	B	x		0.15		-	
		y		0.14		-	
NTSC Ratio	S	50	60	-	%		

Note: The parameter is slightly changed by temperature, driving voltage and materiel

Note 1: The data are measured after LEDs are turned on for 5 minutes. LCM displays full white. The brightness is the average value of 9 measured spots. Measurement equipment BM-7 (Φ 5mm)

Measuring condition:

- Measuring surroundings: Dark room.
- Measuring temperature: Ta=25 °C.
- Adjust operating voltage to get optimum contrast at the center of the display.

Measured value at the center point of LCD panel after more than 5 minutes while backlight

turning on.

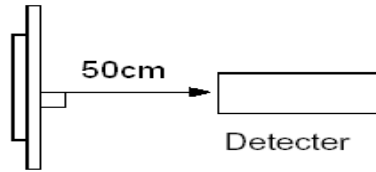

Note 2: The luminance uniformity is calculated by using following formula.

$$\Delta Bp = Bp (\text{Min.}) / Bp (\text{Max.}) \times 100 (\%)$$

$Bp (\text{Max.})$ = Maximum brightness in 9 measured spots

$Bp (\text{Min.})$ = Minimum brightness in 9 measured spots.

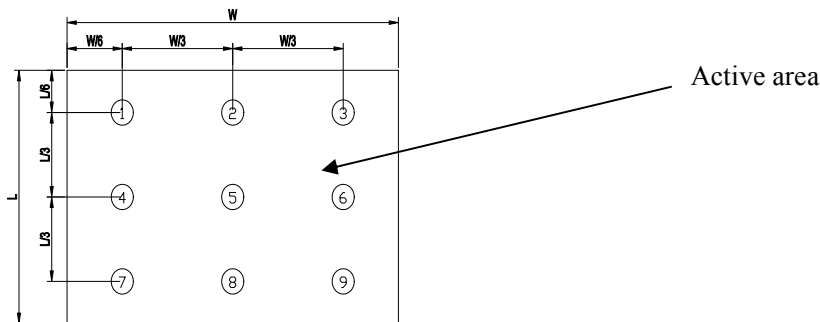

Note 3: The definition of viewing angle:

Refer to the graph below marked by ϑ and ϕ

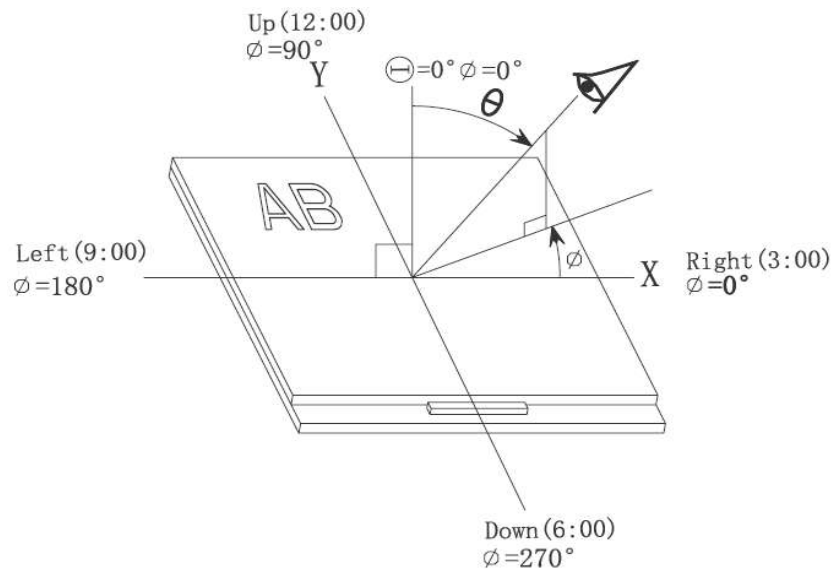

Note 4: Definition of contrast ratio.(Test LCD using DMS501)

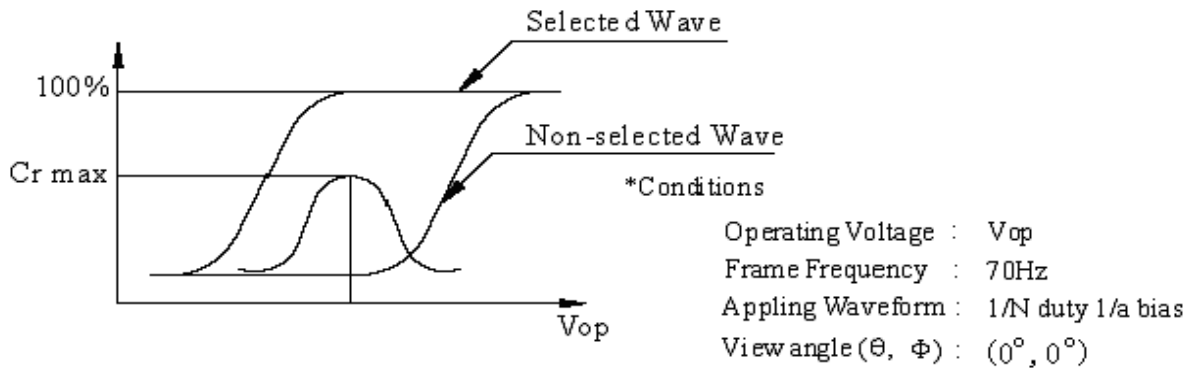

$$\text{Contrast ratio}(Cr) = \frac{\text{Brightness of selected dots}}{\text{Brightness of non-selected dots}}$$

Note 5: Definition of Response time. (Test LCD using DMS501):

The output signals of photo detector are measured when the input signals are changed from "black" to "white"(falling time) and from "white" to "black"(rising time), respectively. The response time is defined as the time interval between the 10% and 90% of amplitudes. Refer to figure as below.

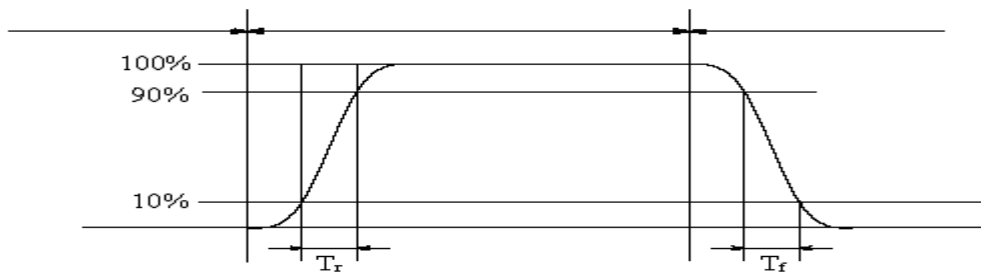

The definition of response time

Note 6: Definition of Color of CIE Coordinate and NTSC Ratio.

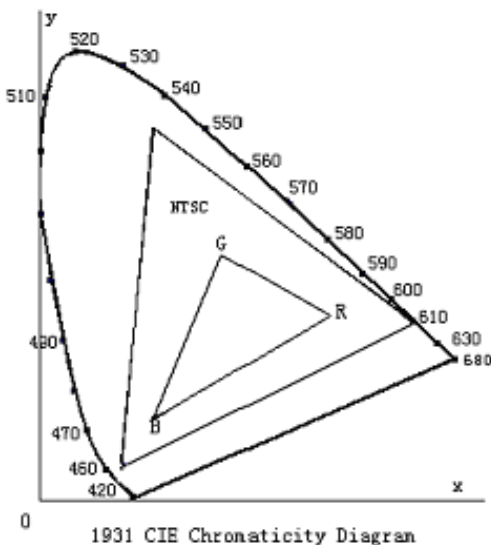

Color gamut:

$$S = \frac{\text{area of RGB triangle}}{\text{area of NTSC triangle}} \times 100\%$$

Note 7: Definition of cross talk.

$$\text{Cross talk ratio}(\%) = \frac{|\text{pattern A Brightness} - \text{pattern B Brightness}|}{\text{pattern A Brightness}} \times 100$$

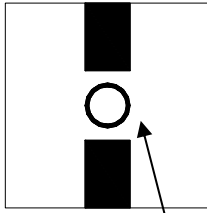

Pattern A

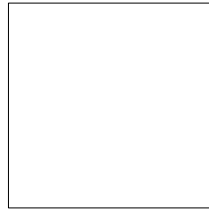

Pattern B

Measurement point(center)

Electric volume value=3F+/-3Hex

8. Reliability Test Items and Criteria

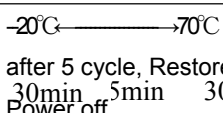
No	Test Item	Test condition	Criterion
1	High Temperature Storage	80°C±2°C 96H Restore 2H at 25°C Power off	Note 1 Note 2 Note 3 Note 4
2	Low Temperature Storage	-30°C±2°C 96H Restore 2H at 25°C Power off	
3	High Temperature Operation	70°C±2°C 96H Restore 2H at 25°C Power on	
4	Low Temperature Operation	-20°C±2°C 96H Restore 4H at 25°C Power on	
5	High Temperature/Humidity Storage	60°C±2°C 90%RH 96H Power off	
6	Temperature Cycle	 after 5 cycle, Restore 2H at 25°C Power off	
7	Vibration Test	10Hz~150Hz, 100m/s2, 120min	

Note: Operation: Supply 3.3V for logic system.

The inspection terms after reliability test, as below

ITEM	Inspection
Contrast	CR>50%
IDD	IDD<200%
Brightness	Brightness>60%
Color Tone	Color Tone+/-0,05

Note 1: T_a is the ambient temperature of samples.

Note 2: T_s is the temperature of panel's surface.

Note 3: In the standard condition, there shall be no practical problem that may after the display function. After the reliability test, the product only guarantees operation, but don't guarantee all of the cosmetic specification.

Note 4: Before cosmetic and function test, the product must have enough recovery time, at least 2 hours at room temperature.

9. Precautions for Use of LCD Modules

9.1 Handling Precautions

9.1.1 *The display panel is made of glass. Do not subject it to a mechanical shock by dropping it from a high place, etc.*

9.1.2 *If the display panel is damaged and the liquid crystal substance inside it leaks out, be sure not to get any in your mouth, if the substance comes into contact with your skin or clothes, promptly wash it off using soap and water.*

9.1.3 *Do not apply excessive force to the display surface or the adjoining areas since this may cause the color tone to vary.*

9.1.4 *The polarizer covering the display surface of the LCD module is soft and easily scratched. Handle this polarizer carefully.*

9.1.5 *If the display surface is contaminated, breathe on the surface and gently wipe it with a soft dry cloth. If still not completely clear, moisten cloth with one of the following solvents:*

— Isopropyl alcohol — Ethyl alcohol

Solvents other than those mentioned above may damage the polarizer. Especially, do not use the following:

— Water — Ketone — Aromatic solvents

9.1.6 *Do not attempt to disassemble the LCD Module.*

9.1.7 *If the logic circuit power is off, do not apply the input signals.*

9.1.8 *To prevent destruction of the elements by static electricity, be careful to maintain an optimum work environment.*

a. Be sure to ground the body when handling the LCD Modules.

b. Tools required for assembly, such as soldering irons, must be properly ground.

c. To reduce the amount of static electricity generated, do not conduct assembly and other work under dry conditions.

d. The LCD Module is coated with a film to protect the display surface. Be care when peeling off this protective film since static electricity may be generated.

9.2 Storage precautions

9.2.1 *When storing the LCD modules, avoid exposure to direct sunlight or to the light of fluorescent lamps.*

9.2.2 *The LCD modules should be stored under the storage temperature range. If the LCD modules will be stored for a long time, the recommend condition is:*

Temperature : 0 °C ~ 40 °C

Relatively humidity: ≤80%

9.2.3 *The LCD modules should be stored in the room without acid, alkali and harmful gas.*

9.3 *The LCD modules should be no falling and violent shocking during transportation, and also should avoid excessive press, water, damp and sunshine.*

END

Our company network supports you worldwide with offices in Germany, Austria, Switzerland, the UK and the USA. For more information please contact:

Headquarters

Germany



FORTEC Elektronik AG

Augsburger Str. 2b
82110 Germering

Phone: +49 89 894450-0
E-Mail: info@forteca.de
Internet: www.forteca.de

Fortec Group Members

Austria



Distec GmbH Office Vienna

Nuschinggasse 12
1230 Wien

Phone: +43 1 8673492-0
E-Mail: info@distec.de
Internet: www.distec.de

Germany



Distec GmbH

Augsburger Str. 2b
82110 Germering

Phone: +49 89 894363-0
E-Mail: info@distec.de
Internet: www.distec.de

Switzerland



ALTRAC AG

Bahnhofstraße 3
5436 Würenlos

Phone: +41 44 7446111
E-Mail: info@altrac.ch
Internet: www.altrac.ch

United Kingdom



Display Technology Ltd.

Osprey House, 1 Osprey Court
Hichingbrooke Business Park
Huntingdon, Cambridgeshire, PE29 6FN

Phone: +44 1480 411600
E-Mail: info@displaytechnology.co.uk
Internet: www.displaytechnology.co.uk

USA



Apollo Display Technologies, Corp.

87 Raynor Avenue,
Unit 1 Ronkonkoma,
NY 11779

Phone: +1 631 5804360
E-Mail: info@apolloDisplays.com
Internet: www.apolloDisplays.com