



OUR GLOBAL  
COMPETENCE  
CENTRES

 APOLLO DISPLAY  
TECHNOLOGIES



 DISTEC



 DISPLAY  
TECHNOLOGY



# Datasheet

## Tianma

**NL6448BC33-70D**

10.4" TFT Display

NL-60-020

# TFT COLOR LCD MODULE

## NL6448BC33-70D

**26cm (10.4 Type)  
VGA**

**DATA SHEET**   
DOD-PP-3040 (4th edition)

**This DATA SHEET is updated document from  
DOD-PP-1432(3).**

**All information is subject to change without notice.  
Please confirm the sales representative before  
starting to design your system.**

## INTRODUCTION

The Copyright to this document belongs to Tianma Japan, Ltd. (hereinafter called "TMJ"). No part of this document will be used, reproduced or copied without prior written consent of TMJ.

TMJ does and will not assume any liability for infringement of patents, copyrights or other intellectual property rights of any third party arising out of or in connection with application of the products described herein except for that directly attributable to mechanisms and workmanship thereof. No license, express or implied, is granted under any patent, copyright or other intellectual property right of TMJ.

Some electronic products would fail or malfunction at a certain rate. In spite of every effort to enhance reliability of products by TMJ, the possibility of failures and malfunction might not be avoided entirely. To prevent the risks of damage to death, human bodily injury or other property arising out thereof or in connection therewith, each customer is required to take sufficient measures in its safety designs and plans including, but not limited to, redundant system, fire-containment and anti-failure.

The products are classified into three grades: "**Standard**", "**Special**", and "**Specific**".

Each quality grade is designed for applications described below. Any customer who intends to use a product for application other than that of Standard is required to contact TMJ sales representative in advance.

**The Standard:** Applications as any failure, malfunction or error of the products are free from any damage to death, human bodily injury or other property (Products Safety Issue) and not related the safety of the public (Social Issues), like general electric devices.

Examples: Office equipment, audio and visual equipment, communication equipment, test and measurement equipment, personal electronic equipment, home electronic appliances, car navigation system (with no vehicle control functions), seat entertainment monitor for vehicles and airplanes, fish finder (except marine radar integrated type), PDA, etc.

**The Special:** Applications as any failure, malfunction or error of the products might directly cause any damage to death, human bodily injury or other property (Products Safety Issue) and the safety of the public (Social Issues) and required high level reliability by conventional wisdom.

Examples: Vehicle/train/ship control system, traffic signals system, traffic information control system, air traffic control system, surgery/operation equipment monitor, disaster/crime prevention system, etc.

**The Specific:** Applications as any failure, malfunction or error of the products might severe cause any damage to death, human bodily injury or other property (Products Safety Issue) and the safety of the public (Social Issues) and developed, designed and manufactured in accordance with the standards or quality assurance program designated by the customer who requires extremely high level reliability and quality.

Examples: Aerospace system (except seat entertainment monitor), nuclear control system, life support system, etc.

The quality grade of this product is the "**Standard**" unless otherwise specified in this document.

**CONTENTS**

<b>INTRODUCTION .....</b>	<b>2</b>
<b>1. OUTLINE.....</b>	<b>4</b>
1.1 STRUCTURE AND PRINCIPLE .....	4
1.2 APPLICATION .....	4
1.3 FEATURES .....	4
<b>2. GENERAL SPECIFICATIONS.....</b>	<b>5</b>
<b>3. BLOCK DIAGRAM.....</b>	<b>6</b>
<b>4. DETAILED SPECIFICATIONS.....</b>	<b>8</b>
4.1 MECHANICAL SPECIFICATIONS .....	8
4.2 ABSOLUTE MAXIMUM RATINGS.....	8
4.3 ELECTRICAL CHARACTERISTICS.....	9
4.3.1 LCD panel signal processing board .....	9
4.3.2 Backlight.....	10
4.3.3 Power supply voltage ripple.....	10
4.3.4 Fuse.....	10
4.4 POWER SUPPLY VOLTAGE SEQUENCE.....	11
4.4.1 LCD panel signal processing board .....	11
4.4.2 LED driver .....	11
4.5 CONNECTIONS AND FUNCTIONS FOR INTERFACE PINS .....	12
4.5.1 LCD panel signal processing board .....	12
4.5.2 Backlight.....	13
4.5.3 Positions of socket .....	13
4.6 DISPLAY COLORS AND INPUT DATA SIGNALS.....	14
4.7 DISPLAY POSITIONS .....	15
4.8 SCANNING DIRECTIONS .....	15
4.9 INPUT SIGNAL TIMINGS .....	16
4.9.1 Outline of input signal timings .....	16
4.9.2 Timing characteristics.....	17
4.9.3 Input signal timing chart.....	19
4.10 OPTICS.....	22
4.10.1 Optical characteristics .....	22
4.10.2 Definition of contrast ratio.....	23
4.10.3 Definition of luminance uniformity .....	23
4.10.4 Definition of response times .....	23
4.10.5 Definition of viewing angles.....	23
<b>5. ESTIMATED LUMINANCE LIFETIME.....</b>	<b>24</b>
<b>6. RELIABILITY TESTS .....</b>	<b>25</b>
<b>7. PRECAUTIONS .....</b>	<b>26</b>
7.1 MEANING OF CAUTION SIGNS .....	26
7.2 CAUTIONS .....	26
7.3 ATTENTIONS.....	26
7.3.1 Handling of the product .....	26
7.3.2 Environment.....	27
7.3.3 Characteristics.....	27
7.3.4 Others.....	27
<b>8. OUTLINE DRAWINGS.....</b>	<b>28</b>
8.1 FRONT VIEW .....	28
8.2 REAR VIEW .....	29

## 1. OUTLINE

### 1.1 STRUCTURE AND PRINCIPLE

Color LCD module NL6448BC33-70D is composed of the amorphous silicon thin film transistor liquid crystal display (a-Si TFT LCD) panel structure with driver LSIs for driving the TFT (Thin Film Transistor) array and a backlight.

The a-Si TFT LCD panel structure is injected liquid crystal material into a narrow gap between the TFT array glass substrate and a color-filter glass substrate.

Color (Red, Green, Blue) data signals from a host system (e.g. signal generator, etc.) are modulated into best form for active matrix system by a signal processing board, and sent to the driver LSIs which drive the individual TFT arrays.

The TFT array as an electro-optical switch regulates the amount of transmitted light from the backlight assembly, when it is controlled by data signals. Color images are created by regulating the amount of transmitted light through the TFT array of red, green and blue dots.

### 1.2 APPLICATION

- For industrial use

### 1.3 FEATURES

- High luminance
- High contrast
- Wide viewing angle
- Wide temperature range
- 6-bit digital RGB signals
- DE (Data enable) function
- Reversible-scan direction
- Long life LED backlight type
- Replaceable lamp for backlight
- Acquisition product for UL60950-1/CSA C22.2 No.60950-1-03 (File number: E170632)
- Compliant with the European RoHS directive (2011/65/EU)



**2. GENERAL SPECIFICATIONS**

<b>Display area</b>	211.2 (H) × 158.4 (V) mm
<b>Diagonal size of display</b>	26cm (10.4 inches)
<b>Drive system</b>	a-Si TFT active matrix
<b>Display color</b>	262,144 colors
<b>Pixel</b>	640 (H) × 480 (V) pixels
<b>Pixel arrangement</b>	RGB (Red dot, Green dot, Blue dot) vertical stripe
<b>Dot pitch</b>	0.11 (H) × 0.33 (V) mm
<b>Pixel pitch</b>	0.33 (H) × 0.33 (V) mm
<b>Module size</b>	243.0 (W) × 185.1 (H) × 10.5 (D) mm (typ.)
<b>Weight</b>	475g (typ.)
<b>Contrast ratio</b>	900:1 (typ.)
<b>Viewing angle</b>	At the contrast ratio $\geq 10:1$ <ul style="list-style-type: none"> <li>• Horizontal: Right side 80° (typ.), Left side 80° (typ.)</li> <li>• Vertical: Up side 80° (typ.), Down side 80° (typ.)</li> </ul>
<b>Designed viewing direction</b>	At DPS= Low or Open: Normal scan <ul style="list-style-type: none"> <li>• Viewing direction without image reversal: Up side (12 o'clock)</li> <li>• Viewing direction with contrast peak: Down side (6 o'clock)</li> <li>• Viewing angle with optimum grayscale (<math>\gamma \approx 2.2</math>): Normal axis (perpendicular)</li> </ul>
<b>Polarizer surface</b>	Antiglare
<b>Polarizer pencil-hardness</b>	3H (min.) [by JIS K5600]
<b>Color gamut</b>	At LCD panel center 40% (typ.) [against NTSC color space]
<b>Response time</b>	$T_{on} + T_{off}$ (10% $\leftrightarrow$ 90%) 18ms (typ.)
<b>Luminance</b>	At IL= 50mA/One circuit 450cd/m <sup>2</sup> (typ.)
<b>Signal system</b>	6-bit digital signals for data of RGB colors, Dot clock (CLK), Data enable (DE), Horizontal synchronous signal (Hsync), Vertical synchronous signal (Vsync)
<b>Power supply voltage</b>	LCD panel signal processing board: 3.3V or 5.0V
<b>Backlight</b>	LED backlight <div style="display: flex; align-items: center;"> <div style="font-size: 2em; margin-right: 10px;">{</div> <div style="margin-right: 10px;">Replaceable part</div> <div style="font-size: 2em; margin-left: 10px;">}</div> </div> <ul style="list-style-type: none"> <li>• Lamp holder set: 104LHS56</li> </ul> <div style="display: flex; align-items: center; margin-top: 10px;"> <div style="font-size: 2em; margin-right: 10px;">{</div> <div style="margin-right: 10px;">Recommended LED driver board (Option)</div> <div style="font-size: 2em; margin-left: 10px;">}</div> </div> <ul style="list-style-type: none"> <li>• LED driver board : 104PW03F</li> <li>• Corresponding wiring harness: 121CBL02</li> </ul>
<b>Power consumption</b>	At IL= 50mA/One circuit, Checkered flag pattern 3.7W (typ.)

**3. BLOCK DIAGRAM**

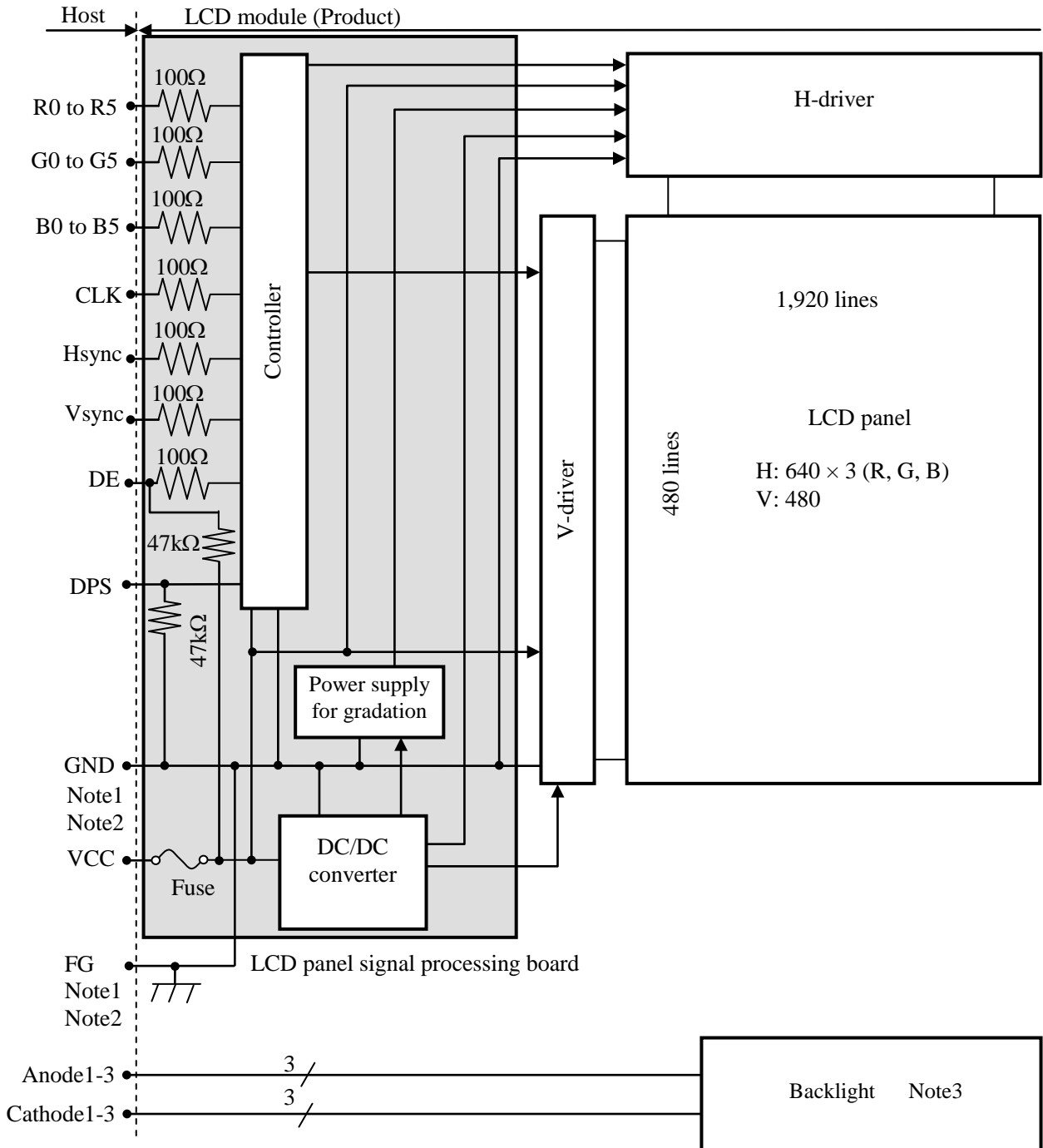

Note1: Relation between GND (Signal ground) and FG (Frame ground) in the LCD module is as follows.

Note2: GND and FG must be connected to customer equipment's ground, and it is recommended that these grounds to be connected together in customer equipment.



Note3: Backlight in detail

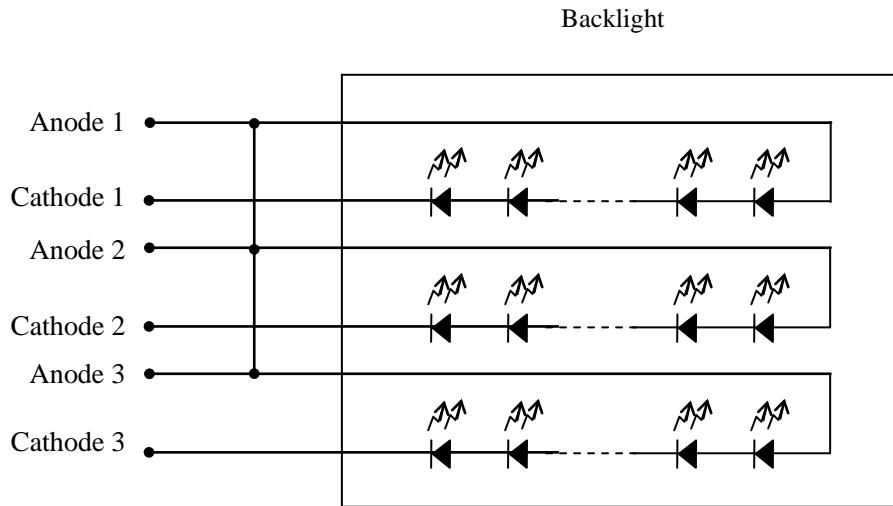

**4. DETAILED SPECIFICATIONS**
**4.1 MECHANICAL SPECIFICATIONS**

Parameter	Specification	Unit
Module size	243.0 ± 0.5 (W) × 185.1 ± 0.5 (H) × 10.5 ± 0.5 (D) <span style="float: right;">Note1</span>	mm
Display area	211.2 (H) × 158.4 (V) <span style="float: right;">Note1</span>	mm
Weight	475 (typ.), 500 (max.)	g

Note1: See "8. OUTLINE DRAWINGS".

**4.2 ABSOLUTE MAXIMUM RATINGS**

Parameter		Symbol	Rating	Unit	Remarks
Power supply voltage	LCD panel signal processing board	VCC	-0.3 to +6.5	V	-
Input voltage for signals	Display signals Note1	VD	-0.3 to VCC+0.3	V	
	Function signal Note2	VF		V	
Backlight	Forward current	IL	60	mA	per one circuit
Storage temperature		Tst	-30 to +80	°C	-
Operating temperature	Front surface	TopF	-30 to +80	°C	Note3
	Rear surface	TopR	-30 to +80	°C	Note4
Relative humidity Note5		RH	≤ 95	%	Ta ≤ 40°C
			≤ 85	%	40°C < Ta ≤ 50°C
			≤ 55	%	50°C < Ta ≤ 60°C
			≤ 36	%	60°C < Ta ≤ 70°C
			≤ 24	%	70°C < Ta ≤ 80°C
Absolute humidity Note5		AH	≤ 70 Note6	g/m <sup>3</sup>	Ta= 80°C

Note1: CLK, Hsync, Vsync, DE, DATA (R0 to R5, G0 to G5, B0 to B5)

Note2: DPS

Note3: Measured at LCD panel surface (including self-heat)

Note4: Measured at LCD module's rear shield surface (including self-heat)

Note5: No condensation

Note6: Water amount at Ta= 80°C and RH= 24%



**4.3 ELECTRICAL CHARACTERISTICS**
**4.3.1 LCD panel signal processing board**

(Ta= 25°C, Note1)

Parameter	Symbol	min.	typ.	max.	Unit	Remarks
Power supply voltage	VCC	3.0	3.3	3.6	V	at VCC= 3.3V
		4.75	5.0	5.25	V	at VCC= 5.0V
Power supply current	ICC	-	300 Note2	410 Note3	mA	at VCC= 3.3V
		-	200 Note2	270 Note3	mA	at VCC= 5.0V
Logic input voltage for display signals	High	VDH	0.7VCC	-	VCC	CMOS level
	Low	VDL	0	-	0.3VCC	
Input voltage for DPS signal	High	VFH	0.7VCC	-	VCC	
	Low	VFL	0	-	0.3VCC	

Note1: When designing of the power supply, take the measures for the prevention of surge voltage.

Note2: Checkered flag pattern [by IEC 61747-6]

Note3: Pattern for maximum current



### 4.3.2 Backlight

(Ta= 25°C, Note1, Note2, Note3)

Parameter	Symbol	min.	typ.	max.	Unit	Remarks
Forward current	IL	-	50.0	55.0	mA	-
Forward Voltage	VL	15.9	18.0	20.4	V	Ta= +25°C at IL= 50mA /One circuit
		14.2	-	-		Ta= +80°C at IL= 50mA /One circuit
		-	-	22.4		Ta= -30°C at IL= 50mA /One circuit
		-	-	22.6		Ta= -30°C at IL= 55mA /One circuit

Note1: Please drive with constant current.

Note2: The above specifications are for one LED circuit of the backlight.

Note3: The Luminance uniformity may be changed depending on the current variation between 3 circuits.

It is recommended that the current value difference among the circuits be less than 5%.

### 4.3.3 Power supply voltage ripple

This product works even if the ripple voltage levels are over the permissible values as the following table, but there might be noise on the display image.

Power supply voltage		Ripple voltage (Measure at input terminal of power supply)	Note1	Unit
VCC	3.3 V	≤ 100		mVp-p
	5.0 V	≤ 100		mVp-p

Note1: The permissible ripple voltage includes spike noise.

### 4.3.4 Fuse

Parameter	Fuse		Rating	Fusing current	Remarks
	Type	Supplier			
VCC	FCC16202AB	KAMAYA ELECTRIC Co., Ltd.	2.0A	4.0A	Note1
			36V		

Note1: The power supply's rated current must be more than the fusing current. If it is less than the fusing current, the fuse may not blow in a short time, and then nasty smell, smoke and so on may occur.

4.4 POWER SUPPLY VOLTAGE SEQUENCE

4.4.1 LCD panel signal processing board

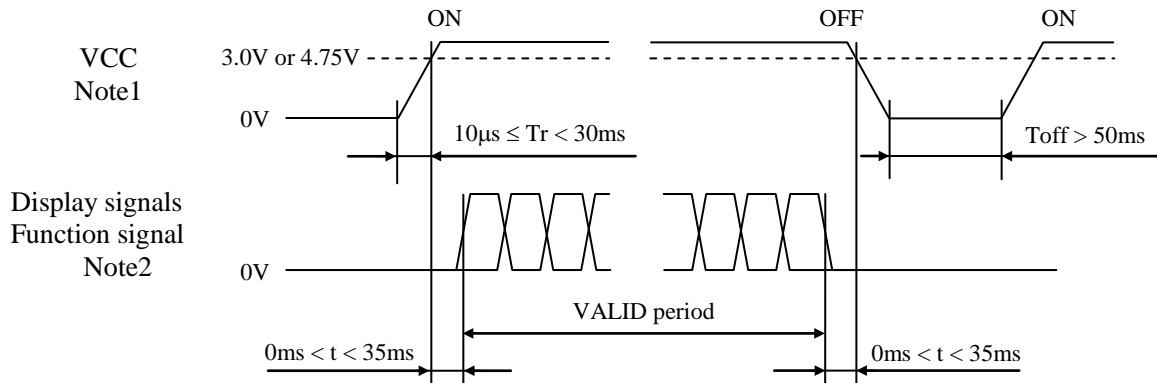

Note1: If there is a voltage variation (voltage drop) at the rising edge of VCC below 3.0V in "VCC = 3.3V" or 4.75V in "VCC = 5.0V", there is a possibility that a product does not work due to a protection circuit.

Note2: Display signals (CLK, Hsync, Vsync, DE, DATA (R0 to R5, G0 to G5, B0 to B5)) and function signal (DPS) must be set to Low or High-impedance, except the VALID period (See above sequence diagram), in order to avoid the circuitry damage.

If some of display and function signals of this product are cut while this product is working, even if the signal input to it once again, it might not work normally. If a customer stops the display and function signals, VCC also must be shut down.

4.4.2 LED driver

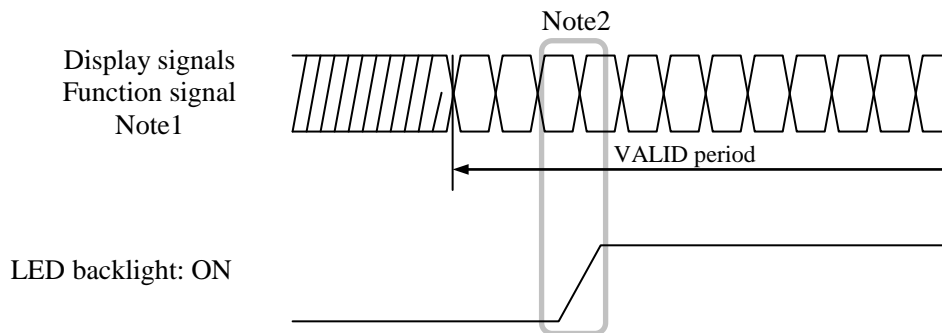

Note1: These are the display and function signals for LCD panel signal processing board.

Note2: The backlight should be turned on within the VALID period of display and function signals, in order to avoid unstable data display.

**4.5 CONNECTIONS AND FUNCTIONS FOR INTERFACE PINS**
**4.5.1 LCD panel signal processing board**

CN1 socket (LCD module side): DF9C-31P-1V (2\*) (Hirose Electric Co., Ltd. (HRS))  
 Adaptable plug: DF9-31S-1V (2\*), DF9-31S-1V (3\*) (Hirose Electric Co., Ltd. (HRS))

Pin No.	Symbol	Signal	Remarks
1	GND	Ground	Note1
2	CLK	Dot clock	-
3	Hsync	Horizontal synchronous signal	
4	Vsync	Vertical synchronous signal	
5	GND	Ground	
6	R0	Red data (LSB)	Least significant bit
7	R1	Red data	-
8	R2	Red data	
9	R3	Red data	
10	R4	Red data	
11	R5	Red data (MSB)	
12	GND	Ground	Note1
13	G0	Green data (LSB)	Least significant bit
14	G1	Green data	-
15	G2	Green data	
16	G3	Green data	
17	G4	Green data	
18	G5	Green data (MSB)	
19	GND	Ground	Note1
20	B0	Blue data (LSB)	Least significant bit
21	B1	Blue data	-
22	B2	Blue data	
23	B3	Blue data	
24	B4	Blue data	
25	B5	Blue data (MSB)	
26	GND	Ground	Note1
27	DE	Selection of DE / Fixed mode	High or Open: Fixed mode Data enable signal: DE mode
28	VCC	Power supply	Note1
29	VCC	Power supply	
30	N.C.	-	Keep this pin Open.
31	DPS	Selection of scan direction	High: Reverse scan Low or Open: Normal scan Note2

Note1: All VCC and GND terminals should be used without any non-connected lines.

Note2: See "**4.8 SCANNING DIRECTIONS**".

4.5.2 Backlight

CN2 socket (LCD module side): SM08B-SRSS-TB (J.S.T. Mfg. Co., Ltd.)

Adaptable plug: SHR-08V-S, SHR-08V-S-B (J.S.T. Mfg. Co., Ltd.)

Pin No.	Symbol	Signal	Remarks
1	A1	Anode1	-
2	K1	Cathode1	-
3	A2	Anode2	-
4	K2	Cathode2	-
5	A3	Anode3	-
6	K3	Cathode3	-
7	N.C.	-	Keep this pin Open.
8	N.C.	-	Keep this pin Open.

4.5.3 Positions of socket

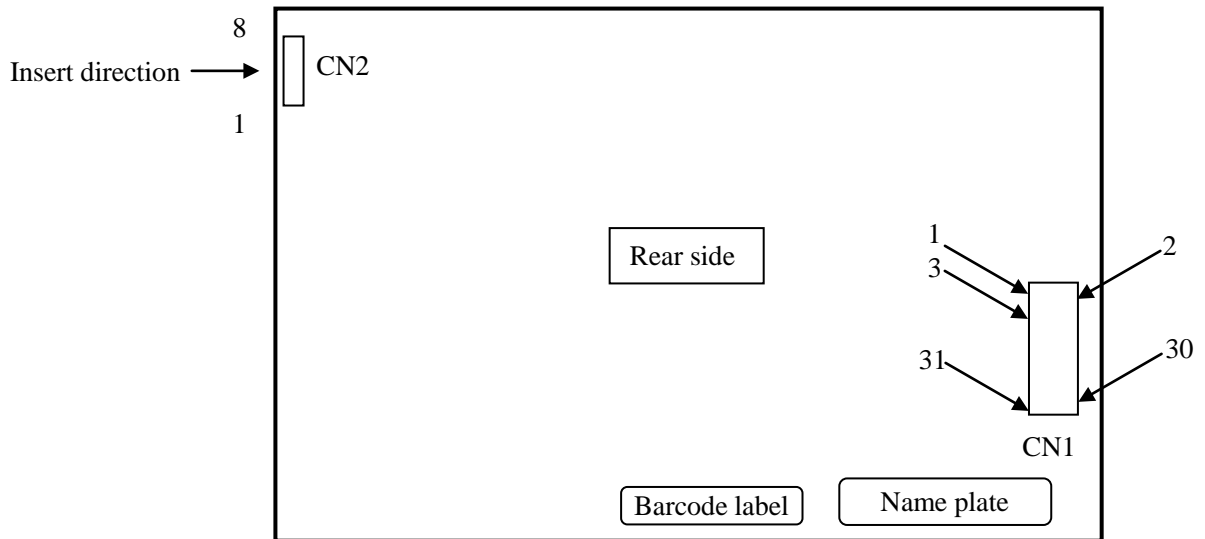

**4.6 DISPLAY COLORS AND INPUT DATA SIGNALS**

This product can display 262,144 colors with 64 gray scales. Also the relation between display colors and input data signals is as follows.

Display colors		Data signal (0: Low level, 1: High level)																	
		R5	R4	R3	R2	R1	R0	G5	G4	G3	G2	G1	G0	B5	B4	B3	B2	B1	B0
Basic colors	Black	0	0	0	0	0	0	0	0	0	0	0	0	0	0	0	0	0	0
	Blue	0	0	0	0	0	0	0	0	0	0	0	0	1	1	1	1	1	1
	Red	1	1	1	1	1	1	0	0	0	0	0	0	0	0	0	0	0	0
	Magenta	1	1	1	1	1	1	0	0	0	0	0	0	1	1	1	1	1	1
	Green	0	0	0	0	0	0	1	1	1	1	1	1	0	0	0	0	0	0
	Cyan	0	0	0	0	0	0	1	1	1	1	1	1	1	1	1	1	1	1
	Yellow	1	1	1	1	1	1	1	1	1	1	1	1	0	0	0	0	0	0
	White	1	1	1	1	1	1	1	1	1	1	1	1	1	1	1	1	1	1
Red gray scale	Black	0	0	0	0	0	0	0	0	0	0	0	0	0	0	0	0	0	0
		0	0	0	0	0	1	0	0	0	0	0	0	0	0	0	0	0	0
	dark	0	0	0	0	1	0	0	0	0	0	0	0	0	0	0	0	0	0
	↑				:					:						:			
	↓				:					:						:			
	bright	1	1	1	1	0	1	0	0	0	0	0	0	0	0	0	0	0	0
	1	1	1	1	1	0	0	0	0	0	0	0	0	0	0	0	0	0	
	1	1	1	1	1	1	0	0	0	0	0	0	0	0	0	0	0	0	
Green gray scale	Black	0	0	0	0	0	0	0	0	0	0	0	0	0	0	0	0	0	0
		0	0	0	0	0	0	0	0	0	0	1	0	0	0	0	0	0	0
	dark	0	0	0	0	0	0	0	0	0	1	0	0	0	0	0	0	0	0
	↑				:					:						:			
	↓				:					:						:			
	bright	0	0	0	0	0	0	1	1	1	1	0	1	0	0	0	0	0	0
	0	0	0	0	0	0	1	1	1	1	1	0	0	0	0	0	0	0	
	0	0	0	0	0	0	1	1	1	1	1	1	0	0	0	0	0	0	
Blue gray scale	Black	0	0	0	0	0	0	0	0	0	0	0	0	0	0	0	0	0	0
		0	0	0	0	0	0	0	0	0	0	0	0	0	0	0	0	0	1
	dark	0	0	0	0	0	0	0	0	0	0	0	0	0	0	0	0	1	0
	↑				:					:						:			
	↓				:					:						:			
	bright	0	0	0	0	0	0	0	0	0	0	0	0	1	1	1	1	0	1
	0	0	0	0	0	0	0	0	0	0	0	0	1	1	1	1	1	0	
	0	0	0	0	0	0	0	0	0	0	0	0	1	1	1	1	1	1	



**4.7 DISPLAY POSITIONS**

The following table is the coordinates per pixel (See "4.8 SCANNING DIRECTIONS".).

C (0, 0)													
<table border="1" style="margin: auto;"> <tr> <td style="padding: 2px;">R</td> <td style="padding: 2px;">G</td> <td style="padding: 2px;">B</td> <td colspan="4"></td> </tr> </table>							R	G	B				
R	G	B											
C( 0, 0)	C( 1, 0)	...	C( X, 0)	...	C(638, 0)	C(639, 0)							
C( 0, 1)	C( 1, 1)	...	C( X, 1)	...	C(638, 1)	C(639, 1)							
⋮	⋮	⋮	⋮	⋮	⋮	⋮							
C( 0, Y)	C( 1, Y)	...	C( X, Y)	...	C(638, Y)	C(639, Y)							
⋮	⋮	⋮	⋮	⋮	⋮	⋮							
C( 0, 478)	C( 1, 478)	...	C( X, 478)	...	C(638, 478)	C(639, 478)							
C( 0, 479)	C( 1, 479)	...	C( X, 479)	...	C(638, 479)	C(639, 479)							

**4.8 SCANNING DIRECTIONS**

The following figures are seen from a front view. Also the arrow shows the direction of scan.

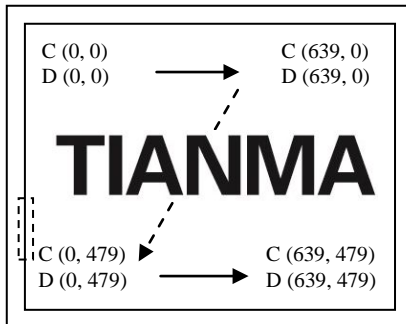

Note1

Figure1. Normal scan (DPS: Low or Open)

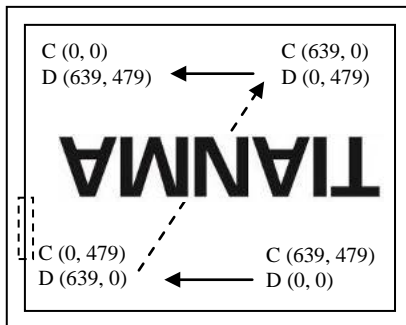

Note1

Figure2. Reverse scan (DPS: High)

Note1: Meaning of C (X, Y) and D (X, Y)

C (X, Y): The coordinates of the display position (See "4.7 DISPLAY POSITIONS".)

D (X, Y): The data number of input signal for LCD panel signal processing board

4.9 INPUT SIGNAL TIMINGS

4.9.1 Outline of input signal timings

• Horizontal signal

Note1

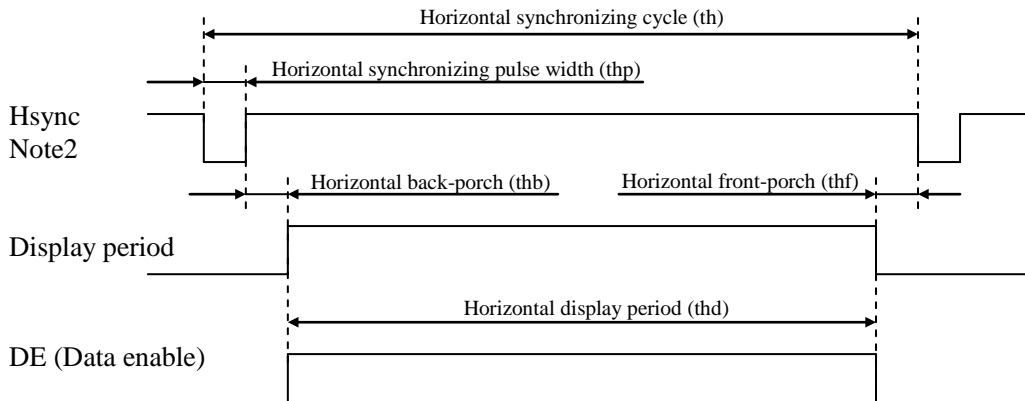

• Vertical signal

Note1

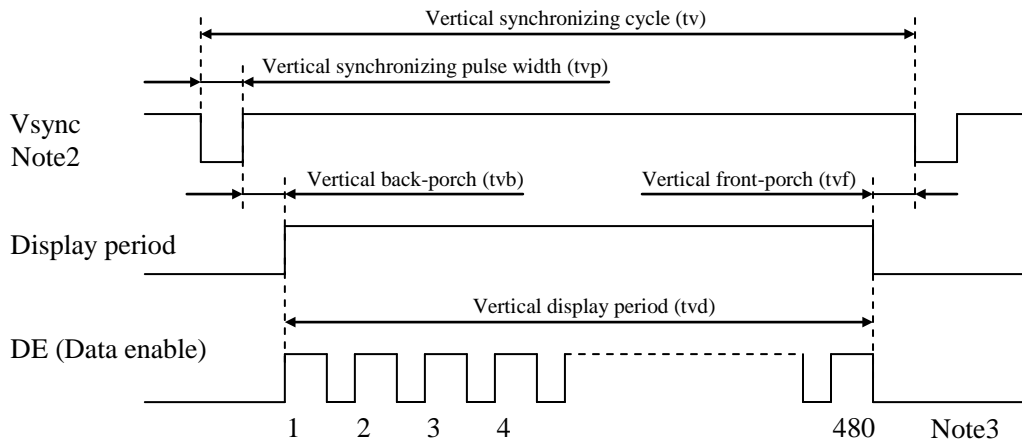

Note1: This diagram indicates virtual signal for set up to timing.  
 Note2: Fixed mode cannot be used while working of DE mode.  
 Note3: See "4.9.3 Input signal timing chart" for the pulse number.

## 4.9.2 Timing characteristics

## (a) Fixed mode

(Note1)

Parameter		Symbol	min.	typ.	max.	Unit	Remarks	
CLK	Frequency	1/tc	21.0	25.175	29.0	MHz	39.72 ns (typ.)	
	Duty ratio	tcd	0.4	0.5	0.6	-	-	
	Rise time, Fall time	trcf	-	-	10	ns		
DATA (R0-R5) (G0-G5) (B0-B5)	CLK-DATA	Setup time	tds	3	-	-	ns	-
		Hold time	tdh	5	-	-	ns	
	Rise time, Fall time	tdrf	-	-	10	ns		
Hsync	Cycle	th	30.0	31.778	33.6	μs	31.468 kHz (typ.)	
			800			CLK	-	
	Display period	thd	640			CLK		
	Front-porch	thf	16			CLK		
	Pulse width	thp	10	96	-	CLK		
	Back-porch	thb	-	48	134	CLK		
	Total of pulse width and back-porch	thp + thb	144			CLK		Note2
	CLK- Hsync	Setup time	ths	3	-	-	ns	-
		Hold time	thh	5	-	-	ns	
	Rise time, Fall time	thrf	-	-	10	ns		
Vsync	Cycle	tv	16.1	16.683	17.2	ms	59.94 Hz (typ.)	
			525			H	-	
	Display period	tvd	480			H		
	Front-porch	tvf	12			H		
	Pulse width	tvp	1	2	-	H		
	Back-porch	tvb	-	31	32	H		
	Total of pulse width and back-porch	tvp + tvb	33			H		Note2
	Hsync-Vsync	Setup time	tvhs	3	-	-	ns	-
		Hold time	tvhh	5	-	-	ns	
Rise time, Fall time	tvrf	-	-	10	ns			

Note1: Definition of parameters is as follows.

 $tc = 1CLK$ ,  $tcd = tch/tc$ ,  $th = 1H$ 

 Note2: Keep  $tv_p + tv_b$  and  $th_p + th_b$  within the table. If it is out of specification, display position will be shifted to right/left side or up/down.

(b) DE mode

(Note1, Note2, Note3)

Parameter		Symbol	min.	typ.	max.	Unit	Remarks	
CLK	Frequency	1/tc	21.0	25.175	29.0	MHz	39.72 ns (typ.)	
	Duty ratio	tcd	0.4	0.5	0.6	-	-	
	Rise time, Fall time	tcrf	-	-	10	ns		
DATA (R0-R5) (G0-G5) (B0-B5)	CLK-DATA	Setup time	tds	3	-	-	ns	-
		Hold time	tdh	5	-	-	ns	
	Rise time, Fall time	tdrf	-	-	10	ns		
DE	Horizontal	Cycle	th	30.0	31.778	33.6	μs	31.468 kHz (typ.)
				-	800	-	CLK	
	Vertical (One frame)	Cycle	tv	16.1	16.683	17.2	ms	59.94 Hz (typ.)
				-	525	-	H	
	CLK-DE	Setup time	tdes	3	-	-	ns	-
		Hold time	tdeh	5	-	-	ns	
	Rise time, Fall time	tderf	-	-	10	ns		

Note1: Definition of parameters is as follows.

 $tc = 1CLK$ ,  $tcd = tch/tc$ ,  $th = 1H$ 

Note2: Hsync signal (Pin No.3 of CN1) and Vsync signal (Pin No.4 of CN1) are not used inside the product at DE mode.

Do not keep pin open to avoid noise problem.

Note3: Vertical cycle (tv) should be specified in integral multiple of Horizontal cycle (th).

4.9.3 Input signal timing chart

(a) Fixed mode

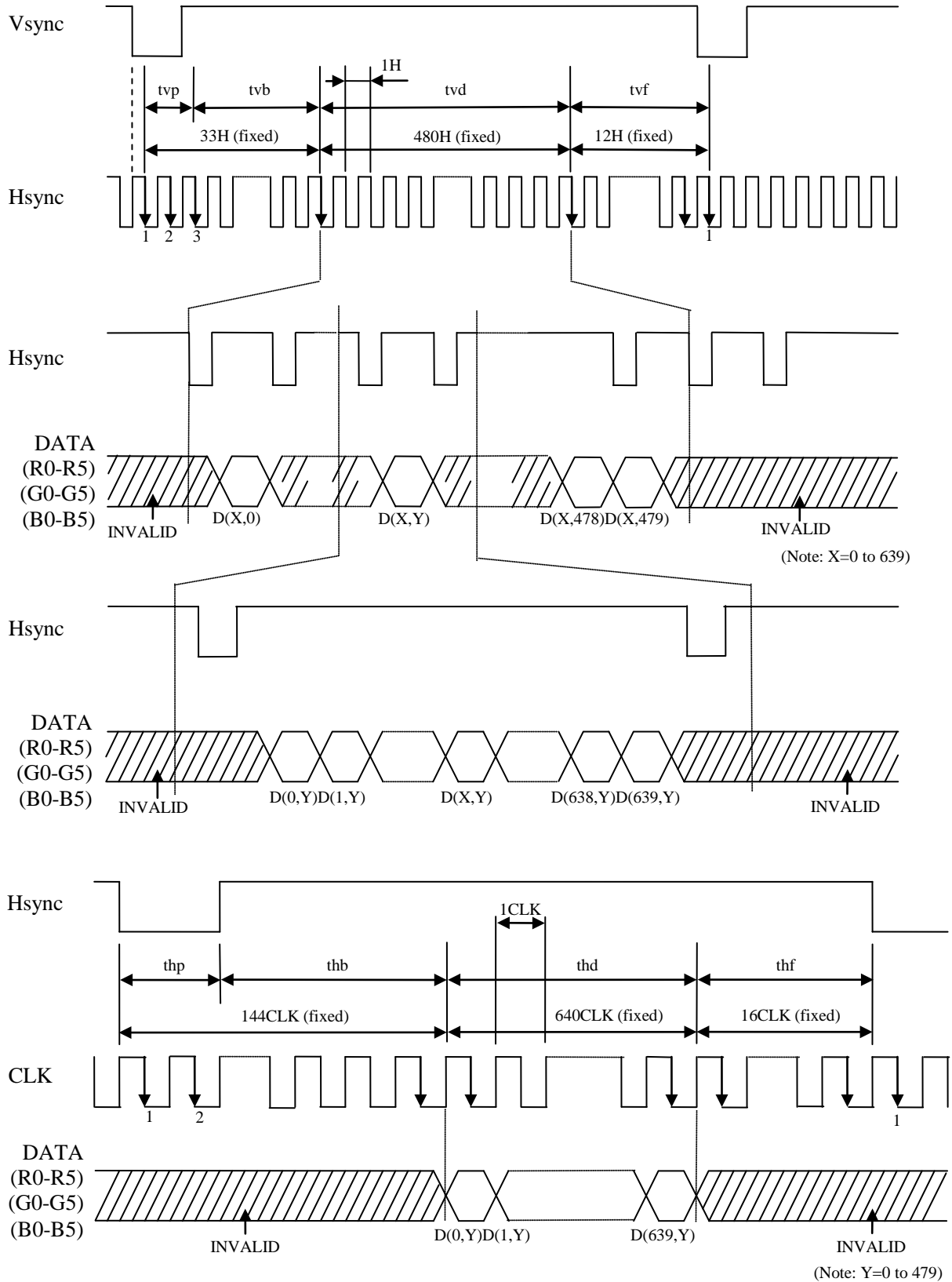

(b) DE mode

Horizontal timing

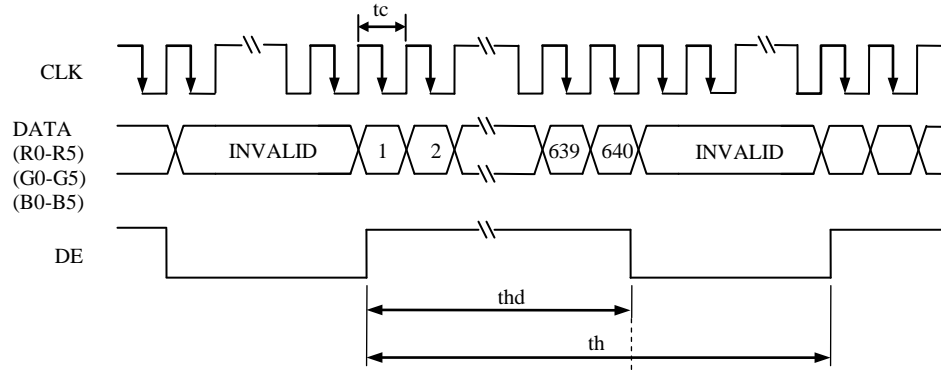

Vertical timing

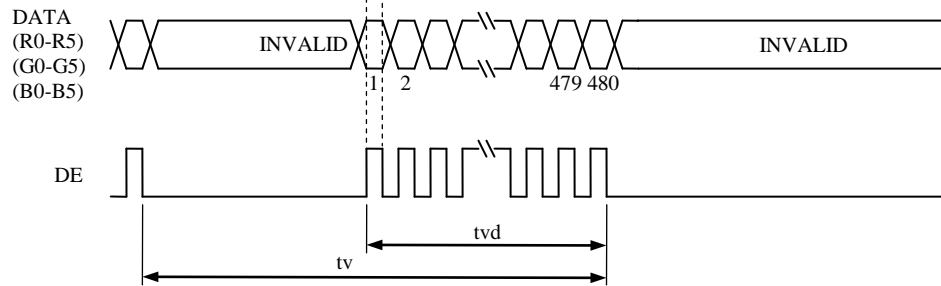

(c) Common item of Fixed mode and DE mode

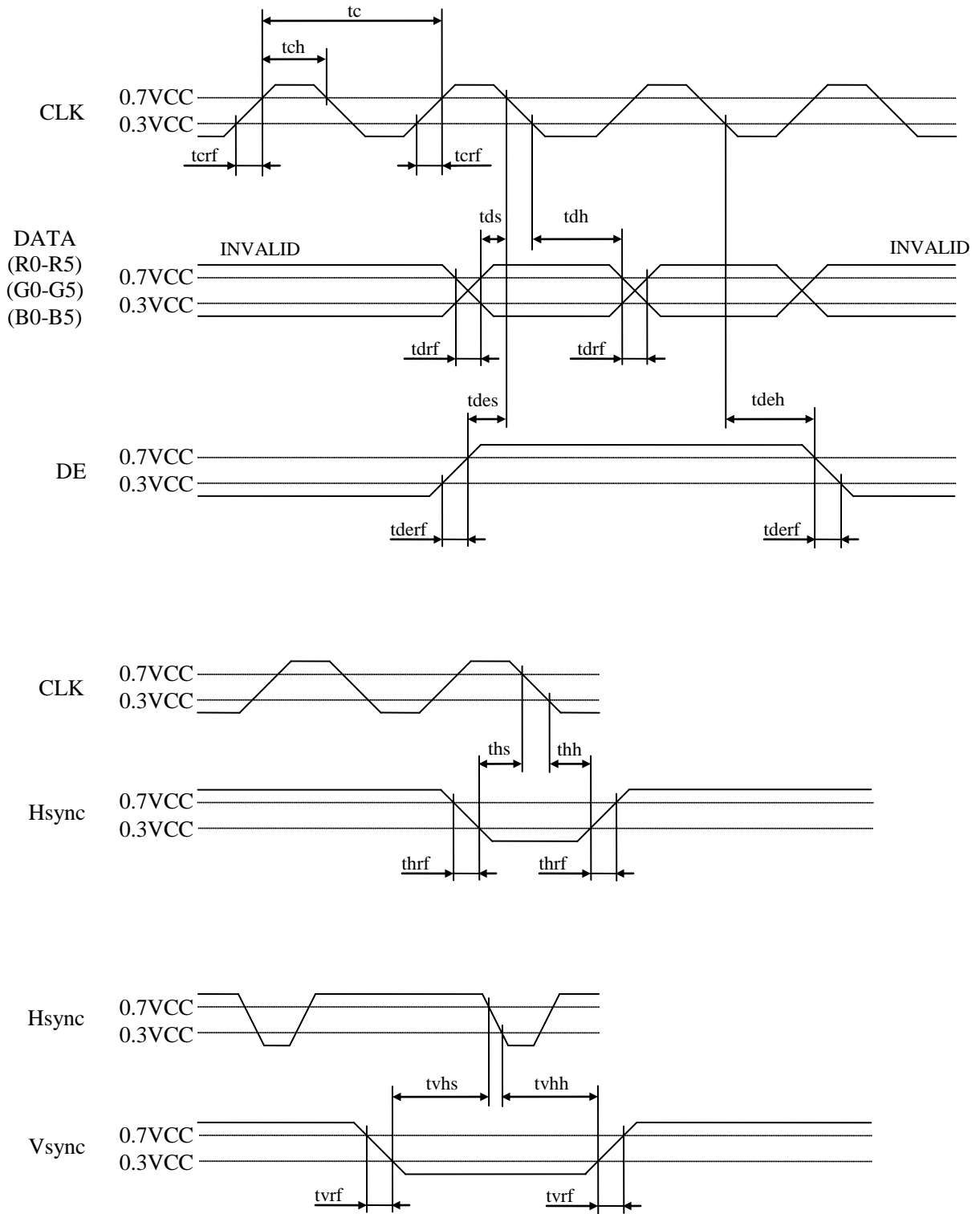

4.10 OPTICS

4.10.1 Optical characteristics

(Note1, Note2)

Parameter	Condition	Symbol	min.	typ.	max.	Unit	Measuring instrument	Remarks	
Luminance	White at center $\theta_R=0^\circ, \theta_L=0^\circ, \theta_U=0^\circ, \theta_D=0^\circ$	L	280	450	-	cd/m <sup>2</sup>	BM-5A or equivalent	-	
Contrast ratio	White/Black at center $\theta_R=0^\circ, \theta_L=0^\circ, \theta_U=0^\circ, \theta_D=0^\circ$	CR	500	900	-	-	BM-5A or equivalent	Note3	
Luminance uniformity	White $\theta_R=0^\circ, \theta_L=0^\circ, \theta_U=0^\circ, \theta_D=0^\circ$	LU	-	1.25	1.4	-	BM-5A or equivalent	Note4	
Chromaticity	White	x coordinate	Wx	0.263	0.313	0.363	-	SR-3 or equivalent	Note5
		y coordinate	Wy	0.279	0.329	0.379	-		
	Red	x coordinate	Rx	-	0.559	-	-		
		y coordinate	Ry	-	0.342	-	-		
	Green	x coordinate	Gx	-	0.355	-	-		
		y coordinate	Gy	-	0.548	-	-		
Blue	x coordinate	Bx	-	0.156	-	-			
	y coordinate	By	-	0.125	-	-			
Color gamut	$\theta_R=0^\circ, \theta_L=0^\circ, \theta_U=0^\circ, \theta_D=0^\circ$ at center, against NTSC color space	C	35	40	-	%			
Response time	White to Black	Ton	-	3	6	ms	BM-5A or equivalent	Note6	
	Black to White	Toff	-	15	21	ms		Note7	
Viewing angle	Right	$\theta_U=0^\circ, \theta_D=0^\circ, CR \geq 10$	$\theta_R$	70	80	-	EZ Contrast	Note8	
	Left	$\theta_U=0^\circ, \theta_D=0^\circ, CR \geq 10$	$\theta_L$	70	80	-			
	Up	$\theta_R=0^\circ, \theta_L=0^\circ, CR \geq 10$	$\theta_U$	70	80	-			
	Down	$\theta_R=0^\circ, \theta_L=0^\circ, CR \geq 10$	$\theta_D$	70	80	-			

Note1: These are initial characteristics.

Note2: Measurement conditions are as follows.

Ta= 25°C, VCC= 3.3V, IL= 50mA/One circuit, Display mode: VGA, Horizontal cycle= 1/31.468kHz, Vertical cycle= 1/59.94Hz, DPS= Low or Open: Normal scan

Optical characteristics are measured at luminance saturation 20minutes after the product works, in the dark room. Also measurement methods are as follows.

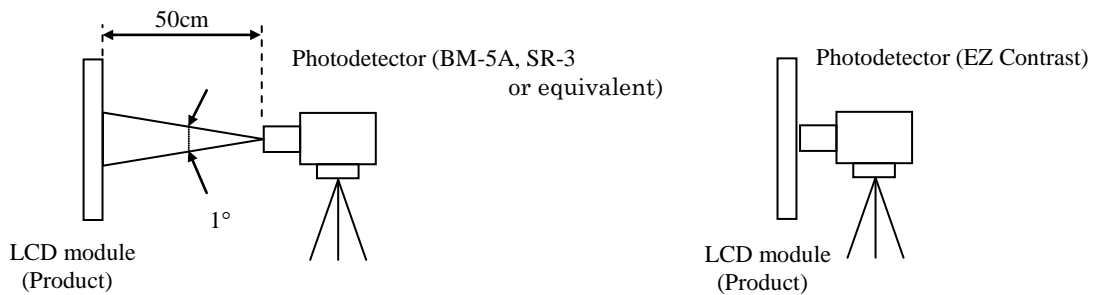

Note3: See "4.10.2 Definition of contrast ratio".

Note4: See "4.10.3 Definition of luminance uniformity".

Note5: These coordinates are found on CIE 1931 chromaticity diagram.

Note6: Product surface temperature: TopF= 32°C

Note7: See "4.10.4 Definition of response times".

Note8: See "4.10.5 Definition of viewing angles".



4.10.2 Definition of contrast ratio

The contrast ratio is calculated by using the following formula.

$$\text{Contrast ratio (CR)} = \frac{\text{Luminance of white screen}}{\text{Luminance of black screen}}$$

4.10.3 Definition of luminance uniformity

The luminance uniformity is calculated by using following formula.

$$\text{Luminance uniformity (LU)} = \frac{\text{Maximum luminance from ① to ⑤}}{\text{Minimum luminance from ① to ⑤}}$$

The luminance is measured at near the 5 points shown below.

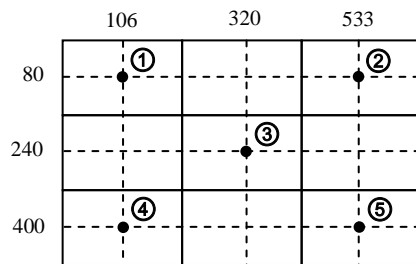

4.10.4 Definition of response times

Response time is measured at the time when the luminance changes from "white" to "black", or "black" to "white" on the same screen point, by photo-detector. Ton is the time when the luminance changes from 90% down to 10%. Also Toff is the time when the luminance changes from 10% up to 90% (See the following diagram.).

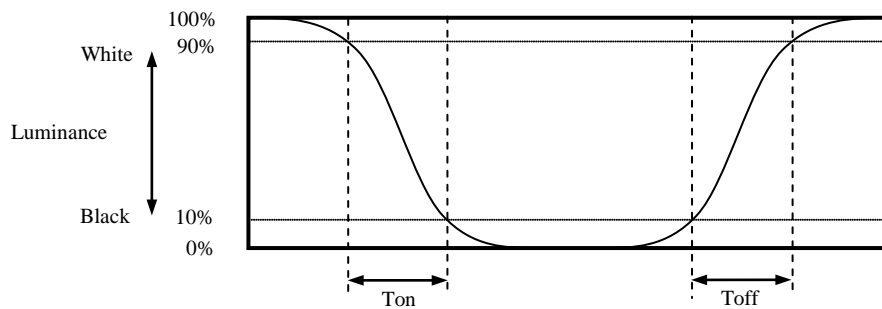

4.10.5 Definition of viewing angles

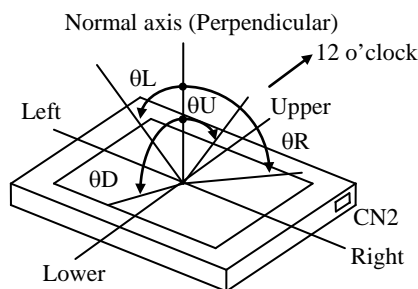

**5. ESTIMATED LUMINANCE LIFETIME**

The luminance lifetime is the time from initial luminance to half-luminance.

**This lifetime is the estimated value, and is not guarantee value.**

Condition		Estimated luminance lifetime (Life time expectancy) Note1, Note2, Note3	Unit
LED elementary substance	25°C (Ambient temperature of the product) Continuous operation, IL= 50mA/one circuit	70,000	h
	80°C (Surface temperature at screen) Continuous operation, IL= 50mA/one circuit	60,000	h

Note1: Life time expectancy is mean time to half-luminance.

Note2: Estimated luminance lifetime is not the value for LCD module but the value for LED elementary substance.

Note3: By ambient temperature, the lifetime changes particularly. Especially, in case the product works under high temperature environment, the lifetime becomes short.

**6. RELIABILITY TESTS**

Test item	Condition	Judgment	Note1	
High temperature and humidity (Operation)	① 60 ± 2°C, RH= 90%, 240hours ② Display data is black.	No display malfunctions		
High temperature (Operation)	① 80 ± 3°C, 240hours ② Display data is black.			
Heat cycle (Operation)	① -30 ± 3°C 1hour 80 ± 3°C 1hour ② 50cycles, 4hours/cycle ③ Display data is black.			
Thermal shock (Non operation)	① -30 ± 3°C 30minutes 80 ± 3°C 30minutes ② 100cycles, 1hour/cycle ③ Temperature transition time is within 5 minutes.			
ESD (Operation)	① 150pF, 150Ω, ±10kV ② 9 places on a panel surface ③ 10 times each place at 1 sec interval			Note2
Dust (Operation)	① Sample dust: No. 15 (by JIS-Z8901) ② 15 seconds stir ③ 8 times repeat at 1 hour interval			
Vibration (Non operation)	① 5 to 100Hz, 19.6m/s <sup>2</sup> ② 1 minute/cycle ③ X, Y, Z directions ④ 120 times each direction	No display malfunctions No physical damages		
Mechanical shock (Non operation)	① 539m/ s <sup>2</sup> , 11ms ② ±X, ±Y, ±Z directions ③ 5 times each direction			

Note1: Display and appearance are checked under environmental conditions equivalent to the inspection conditions of defect criteria.

Note2: See the following figure for discharge points.

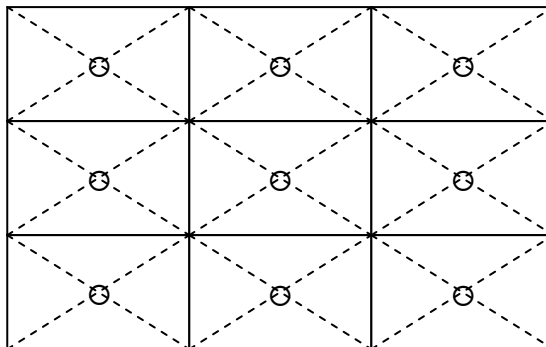

## 7. PRECAUTIONS

### 7.1 MEANING OF CAUTION SIGNS

The following caution signs have very important meaning. **Be sure to read "7.2 CAUTIONS" and "7.3 ATTENTIONS"!**



This sign has the meaning that a customer will be injured or the product will sustain damage if the customer practices wrong operations.



This sign has the meaning that a customer will be injured if the customer practices wrong operations.

### 7.2 CAUTIONS



**\* Do not shock and press the LCD panel and the backlight! There is a danger of breaking, because they are made of glass. (Shock: Equal to or no greater than  $539\text{m/s}^2$  and equal to or no greater than  $11\text{ms}$ , Pressure: Equal to or no greater than  $19.6\text{ N}$  ( $\phi 16\text{mm}$  jig))**

### 7.3 ATTENTIONS



#### 7.3.1 Handling of the product

- ① Take hold of both ends without touching the circuit board when the product (LCD module) is picked up from inner packing box to avoid broken down or misadjustment, because of stress to mounting parts on the circuit board.
- ② When the product is put on the table temporarily, display surface must be placed downward.
- ③ When handling the product, take the measures of electrostatic discharge with such as earth band, ionic shower and so on, because the product may be damaged by electrostatic.
- ④ The torque for product mounting screws must never exceed  $0.294\text{N}\cdot\text{m}$ . Higher torque might result in distortion of the bezel.
- ⑤ The product must be installed using mounting holes without undue stress such as bends or twist (See outline drawings). And do not add undue stress to any portion (such as bezel flat area). Bends or twist described above and undue stress to any portion may cause display mura.
- ⑥ Do not press or rub on the sensitive product surface. When cleaning the product surface, wipe it with a soft dry cloth.
- ⑦ Do not push or pull the interface connectors while the product is working.
- ⑧ When handling the product, use of an original protection sheet on the product surface (polarizer) is recommended for protection of product surface. Adhesive type protection sheet may change color or characteristics of the polarizer.
- ⑨ Usually liquid crystals don't leak through the breakage of glasses because of the surface tension of thin layer and the construction of LCD panel. But, if you contact with liquid crystal by any chance, please wash it away with soap and water.

7.3.2 Environment

- ① Do not operate or store in high temperature, high humidity, dewdrop atmosphere or corrosive gases. Keep the product in packing box with antistatic pouch in room temperature to avoid dusts and sunlight, when storing the product.
- ② In order to prevent dew condensation occurred by temperature difference, the product packing box must be opened after enough time being left under the environment of an unpacking room. Evaluate the storage time sufficiently because dew condensation is affected by the environmental temperature and humidity. (Recommended leaving time: 6 hours or more with the original packing state after a customer receives the package)
- ③ Do not operate in high magnetic field. If not, circuit boards may be broken.
- ④ This product is not designed as radiation hardened.

7.3.3 Characteristics

**The following items are neither defects nor failures.**

- ① Characteristics of the LCD (such as response time, luminance, color uniformity and so on) may be changed depending on ambient temperature. If the product is stored under condition of low temperature for a long time, it may cause display mura. In this case, the product should be operated after enough time being left under condition of operating temperature.
- ② Display mura, flickering, vertical streams or tiny spots may be observed depending on display patterns.
- ③ Do not display the fixed pattern for a long time because it may cause image sticking. Use a screen saver, if the fixed pattern is displayed on the screen.
- ④ The display color may be changed depending on viewing angle because of the use of condenser sheet in the backlight.
- ⑤ Optical characteristics may be changed depending on input signal timings.

7.3.4 Others

- ① All GND and VCC terminals should be used without any non-connected lines.
- ② Do not disassemble a product or adjust variable resistors.
- ③ See "REPLACEMENT MANUAL FOR LAMP HOLDER SET", when replacing lamp holder set .
- ④ Pack the product with the original shipping package, in order to avoid any damages during transportation, when returning the product to TMJ for repairing and so on.
- ⑤ The information of China RoHS (II ) six hazardous substances or elements in this product is as follows. ☆

China RoHS (II ) six hazardous substances or elements					
Lead (Pb)	Mercury (Hg)	Cadmium (Cd)	Hexavalent Chromium (Cr VI)	Polybrominated Biphenyls (PBB)	Polybrominated Biphenyl Ethers (PBDE)
×	○	○	○	○	○

Note1: ○ : This indicates that the poisonous or harmful material in all the homogeneous materials for this part is equal or below the limitation level of GB/T26572-2011 standard regulation.

× : This indicates that the poisonous or harmful material in all the homogeneous materials for this part is above the limitation level of GB/T26572-2011 standard regulation.

8. OUTLINE DRAWINGS

8.1 FRONT VIEW

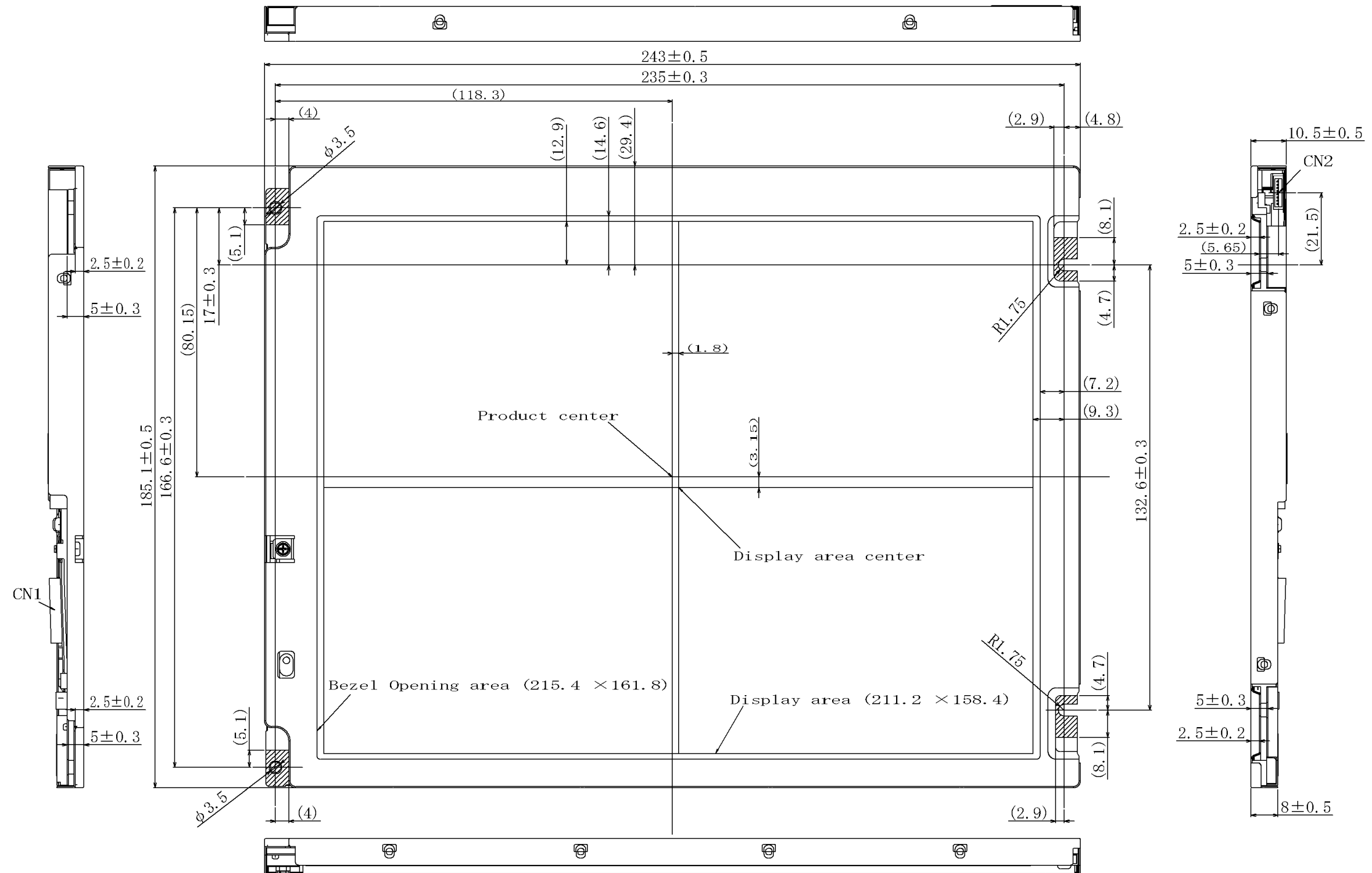

Note1: The values in parentheses are for reference.

Note2: The torque for product mounting screws must never exceed 0.294N·m.

Note3:  Mounting hole portions (4 pieces)

Unit: mm

8.2 REAR VIEW

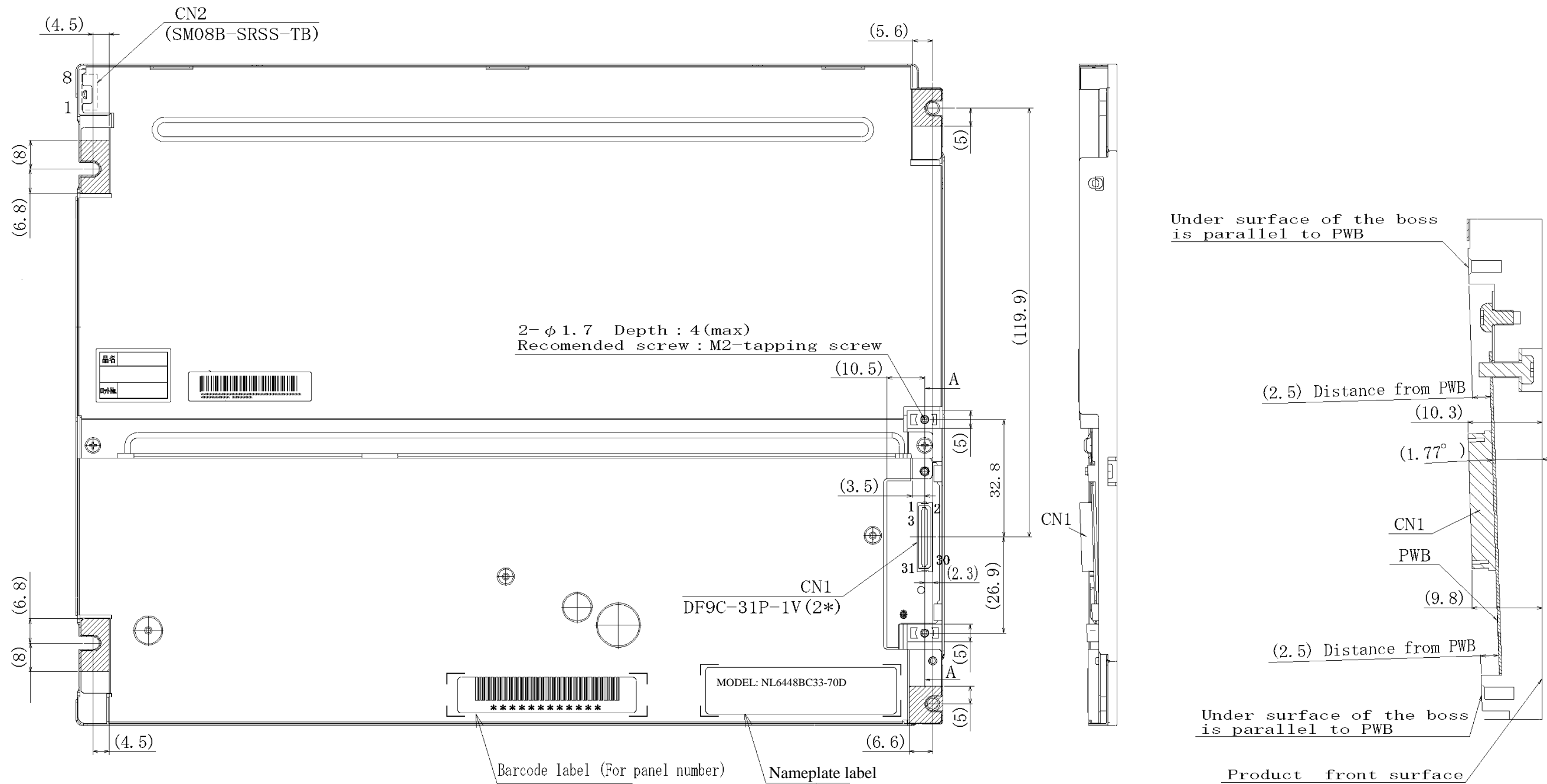

Sec. A-A

- Note1: The values in parentheses are for reference.
- Note2: The torque for product mounting screws must never exceed 0.294N·m.
- Note3: Mounting hole portions (4 pieces)

Unit: mm ☆  
☆

Our company network supports you worldwide with offices in Germany, Austria, Switzerland, the UK and the USA. For more information please contact:

## Headquarters

### Germany



**FORTEC Elektronik AG**  
Lechwiesenstr. 9  
86899 Landsberg am Lech

Phone: +49 8191 91172-0  
E-Mail: [sales@forteca.de](mailto:sales@forteca.de)  
Internet: [www.forteca.de](http://www.forteca.de)

## Fortec Group Members

### Austria



**FORTEC Elektronik AG**  
**Office Vienna**

Nuschinggasse 12  
1230 Wien

Phone: +43 1 8673492-0  
E-Mail: [office@fortec.at](mailto:office@fortec.at)  
Internet: [www.fortec.at](http://www.fortec.at)

### Germany



**Distec GmbH**

Augsburger Str. 2b  
82110 Germering

Phone: +49 89 894363-0  
E-Mail: [info@distec.de](mailto:info@distec.de)  
Internet: [www.distec.de](http://www.distec.de)

### Switzerland



**ALTRAC AG**

Bahnhofstraße 3  
5436 Würenlos

Phone: +41 44 7446111  
E-Mail: [info@altrac.ch](mailto:info@altrac.ch)  
Internet: [www.altrac.ch](http://www.altrac.ch)

### United Kingdom



**Display Technology Ltd.**

Osprey House, 1 Osprey Court  
Hichingbrooke Business Park  
Huntingdon, Cambridgeshire, PE29 6FN

Phone: +44 1480 411600  
E-Mail: [info@displaytechnology.co.uk](mailto:info@displaytechnology.co.uk)  
Internet: [www.displaytechnology.co.uk](http://www.displaytechnology.co.uk)

### USA



**Apollo Display Technologies, Corp.**

87 Raynor Avenue,  
Unit 1 Ronkonkoma,  
NY 11779

Phone: +1 631 5804360  
E-Mail: [info@apolloDisplays.com](mailto:info@apolloDisplays.com)  
Internet: [www.apolloDisplays.com](http://www.apolloDisplays.com)