

# Datasheet

## Abon Touch

**AB-1515003211218122001**

TO-19-102R1.2

**FORTEC**  
UNITED STATES



**FORTEC**  
INTEGRATED



**FORTEC**  
UNITED KINGDOM



---

The information contained in this document has been carefully researched and is, to the best of our knowledge, accurate. However, we assume no liability for any product failures or damages, immediate or consequential, resulting from the use of the information provided herein. Our products are not intended for use in systems in which failures of product could result in personal injury. All trademarks mentioned herein are property of their respective owners. All specifications are subject to change without notice.

---



嵩達光電科技股份有限公司

# PRODUCT SPECIFICATIONS

V2.0

5-Wire Analog Resistive Touch Screen

Model Number: AB-1515003211218122001

Made by : Irene Lin

2017/12/22

Approved:  嵩達光電科技股份有限公司  (ABON TOUCHSYSTEM INC.)	Approved:

## RELEASE HISTORY

Version	Release Date	Release Description	Issuer
V1.0	2014.10.13	Initial	Maggie Wang
V1.1	2014.10.28	Remove Section 3.1.2, merge to Section 3.1.1	Maggie Wang
V1.2	2015.05.06	Modify 5.Appearance Specification	Zoe Chang
V1.3	2015.10.01	Modify 6.2 and 6.2.2	Irene Lin
V2.0	2016.08.15	Modify the description of English	Irene Lin

<Remarks>

## CONTENT

---

Release History .....	ii
Glossary.....	5
1.Purpose [目的] .....	6
2. Product Introduction [產品介紹].....	7
2.1 Basic Information [基本].....	7
2.2 Product Dimensions [產品尺寸] .....	7
2.3 Engineering DIM [工程圖] .....	7
3. Product detail Properties [產品特性] .....	9
3.1 Environmental Properties [環境特性] .....	9
3.1.1 Temperature [溫度] .....	9
3.2 Optical Properties [光學特性].....	10
3.3 Electrical Properties [電子特性].....	10
3.4 Physical & Reliability [物理&耐受性] .....	10
4. Test and Verification [測試及驗證].....	12
4.1 Acceptance Criteria [驗收標準].....	12
4.2 Reliability Test [信賴性測試] .....	12
4.2.1 High Temperature & Humidity [高溫高濕] .....	12
4.2.2 High Temperature [高溫] .....	13
4.2.3 Low Temperature [低溫] .....	13
4.2.4 Thermal Cycling [冷熱循環].....	13
4.3 Durability Touch Test [耐久性觸摸測試] .....	14
4.3.1 Touch Test Method [觸摸測試方式] .....	14
4.4 Linearity Test [線性測試] .....	16

5. Appearance Specification [外觀規範]	18
5.1 Detection Method [檢驗方式]	18
5.2 Detection Criteria [外觀檢測標準]	20
5.2.1 Determination [定義]	20
5.2.2 Criteria and Determination [標準及判定]	21
6. Attention [注意事項]	23
6.1 On Storage [儲放]	23
6.1.1 After Assembly [組裝後]	23
6.1.2 Before Assembly [組裝前]	23
6.2 Inteeegrated Assembly [組裝]	24
6.2.1 Gasket [前墊片]	24
6.2.2 the Gap between Bezel Opening and Top Surface	25
[前蓋框與觸控屏幕表面的空間]	25
6.2.3 Bezel opening [前蓋]	25
6.2.4 Tail [連接線]	25
6.3 On Operating [操作]	26
6.4 On Cleaning [清潔]	26
6.5 on unpacking [拆裝]	26
6.6 Carrying [搬運]	26
7. Limited Warranty [有限保固]	27
7.1 Warranty Information [保固內容]	27
7.2 Warranty Exclusive [非保固範圍]	27
8. Appendix [附件]	28

## GLOSSARY

---

FPC: Flex Printed Circuit

FFC: Flat Flexible Cable

DUT: Device Under Test

RA Test: Reliability Test

L: Length

D: Diameter

W: Width

T: Thickness

mm: millimeter

hr: hour

min: minute

## 1.PURPOSE [目的]

---

This documentation is to be defined the 5 wires resistive touch screen products, respectively, specification and quality requirements.

The paper involves a detail description and definition about the products, from engineering design and product properties.

In addition, ABON TOUCHSYSTEM INC. is all right reserved for specification and product design.

此份文件是用來定義五線類比電阻觸控屏幕的詳細產品規格，包括產品本身及質量相關的需求。並且從工程設計的角度來詳盡的描述五線電阻類產品相關的一切特性。

另外要強調的是，嵩達光電科技股份有限公司保有一切修改的權利，例如產品規格及設計。

## 2. PRODUCT INTRODUCTION [產品介紹]

### 2.1 BASIC INFORMATION [基本]

- Product Type : Five-Wire Analog Resistive Touch Screen

產品類型：五線-類比電阻式觸控屏幕

- Operating Method: Stylus or Finger

操作方式：使用觸控筆或者手指

- Tail Type: FFC

出線方式：FFC

### 2.2 PRODUCT DIMENSIONS [產品尺寸]

ITEMS [名稱]	SIZE (UNIT- mm) [尺寸]	TOLERANCE [公差]
Frame Area [外框]	322.00 mm X 245.50 mm	± 0.30 mm
Viewable Area [可視區]	309.50 mm X 233.50 mm	± 0.20 mm
Active Area [動作區]	303.50 mm X 227.50 mm	± 0.20 mm
Total Thickness [總厚度]	2.20 mm	± 0.20 mm
Tail Length [出線長度]	205.00 mm	± 6.00 mm

### 2.3 ENGINEERING DIM [工程圖]

DIM VERSION: REV - A

DIM NO: AB-1515003211218122001



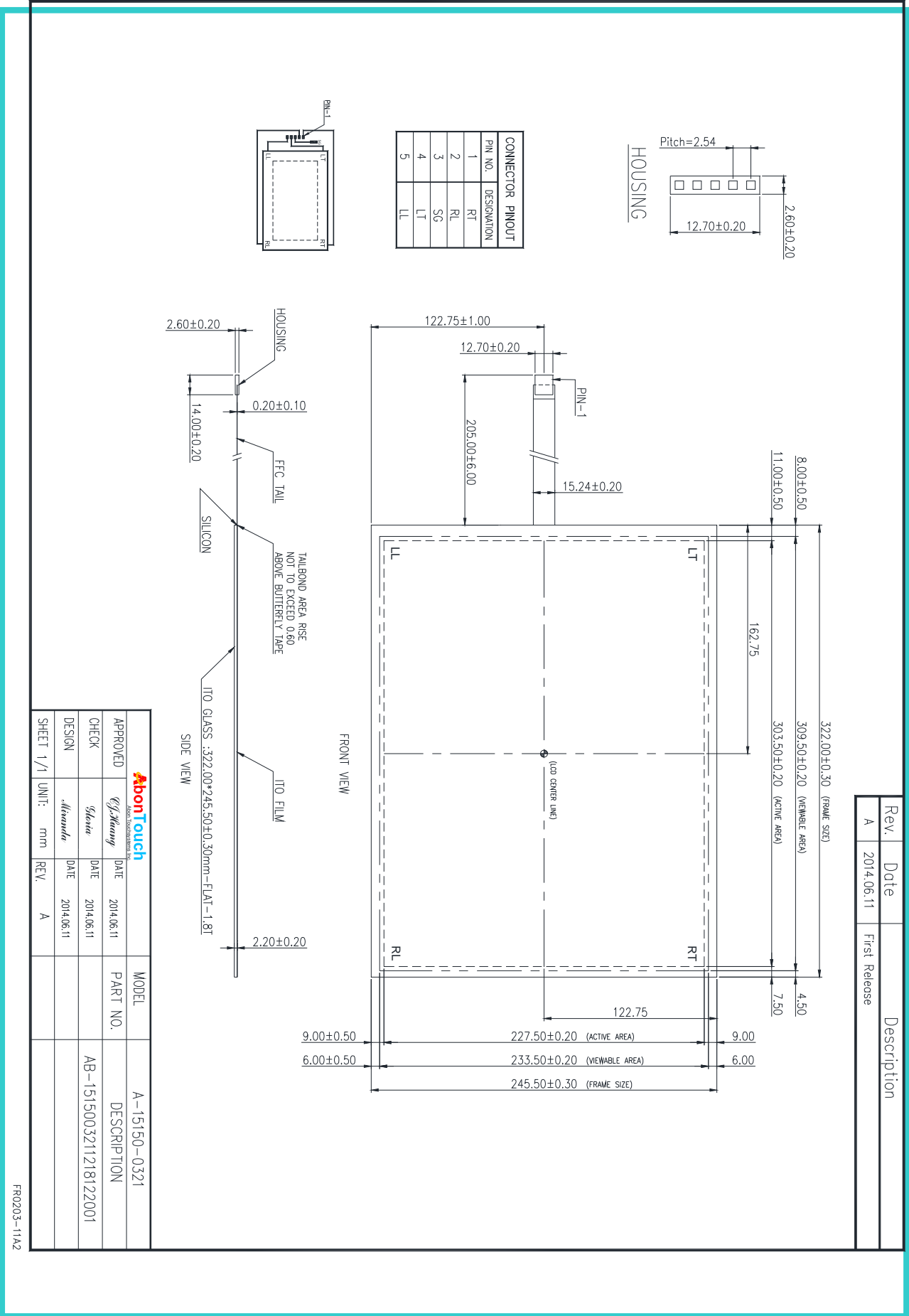

### 3. PRODUCT DETAIL PROPERTIES [產品特性]

---

#### 3.1 ENVIRONMENTAL PROPERTIES [環境特性]

---

All environmental properties have been verified under one standard atmosphere.

所有環境特性相關的數值是定義在一個標準大氣壓時。

---

##### 3.1.1 TEMPERATURE [溫度]

---

Operation Temperature [操作溫度]: - 30°C ~ 70°C at normal humidity (90%RH at Maximum 50°C)

Storage Temperature [儲存溫度]: - 40°C ~ 80°C at normal humidity (90%RH at Maximum 50°C)

---

*\* Remark: 1. Condensation cannot be existed either in operating and storage conditions.*

*2. The maximum temperature cannot be higher than 50°C when environment humidity reach 90%RH*

*3. To specify the maximum humidity of storage is based on the transportation of specification for package*

*\*備註: 1. 無論儲存或操作，環境濕度不能出現凝結現象*

*2. 當產品處於高濕度環境中並達到90%RH，其溫度同時不能超過50°C*

*3. 儲藏濕度臨界點的定義僅限於規定包裝內的運輸*

---

## 3.2 OPTICAL PROPERTIES [光學特性]

ITEM [名稱]	SPECIFICATION [規格]	REMARK [注釋]
Transparency [透光度]	80% ± 5%	Measured by BYK-Gardner - ASTM D1003
Haze [霧化度]	8% ± 2%	Measured by BYK-Gardner - ASTM D1003

## 3.3 ELECTRICAL PROPERTIES [電子特性]

- Operating Voltage [操作電壓]: 3.3 ~ 5 V DC
- Loop Resistance [迴路阻抗]: X:20~500Ω, Y:20~500Ω
- Linearity Tolerance [線性公差範圍]: Maximum Deviation  $\leq 1.5\%$  (Refer Section 4.4)
- Insulation [絕緣阻抗]:  $\geq 20M\Omega$ , 25V DC

## 3.4 PHYSICAL &amp; RELIABILITY [物理&amp;耐受性]

TOUCH SCREEN [螢幕區]		
ITEM [名稱]	CRETIRIA & PARAMETER [標準&參數]	RELIABILITY DETERMINATION [耐受度定義]
Operating Force [作動力]	R8.0 Silicon Rubber Hs60°	Force < 50g
Impact [撞擊]	25.0 Φ DIA/ 67g Steel Ball 80cm Height [25 Φ /67g 鋼球，高度=80cm]	Impact central area by 1 time, surface cannot be damaged [中央區域撞擊 1 次，不能破損]

<p>Static Load [靜態承重]</p>	<p>15kg within <math>\Phi</math> 20mm area for 30sec [15kg 置於 <math>\Phi</math> 20mm 內，30 秒]</p>	<p>The product performance must fulfill the criteria of electrical properties, which defined in Section 3.3 [性能需滿足定義在 Section 3.3 的電子特性]</p>
<p>Operating Surface Hardness [硬度]</p>	<p>3H pencil, pressure 765g/45° (JIS K5600,ASTM D3363) [鉛筆 3H,壓力 765g/45° (JIS K5600,ASTM D3363)]</p>	<p>Surface Hardness <math>\geq</math> 3H</p>
<p><b>TAIL</b> [連結線]</p>		
<p><b>ITEM</b> [名稱]</p>	<p><b>CRETIRIA &amp; PARAMETER</b> [標準&amp;參數]</p>	<p><b>RELIABILITY DETERMINATION</b> [耐受度定義]</p>
<p>Tail Peeling [連接線剝離]</p>	<p>Apply 800g force pulling vertically down by 90 degrees [800g, 往下垂直 90°拉扯]</p>	<p>Function of products need to be fulfilled Electrical Properties mentioned on Section 3.3</p>
<p>Tail Bending [連接線繞折]</p>	<p>135°and left &amp; right 10 times [135°角,左右來回 10 次]</p>	<p>[功能需符合 Section 3.3 中描述的電子特性]</p>

## 4. TEST AND VERIFICATION [測試及驗證]

All touch screens must be passed for the reliability, durability and linearity test to ensure usage performance. The functionality must be fulfilled the criteria defined in this specification, especially on optical and electrical properties, mentioned on Section 3.2 and 3.3.

觸控螢幕將經過下述信賴性測試，耐受力測試及線性測試的驗證以確保其在使用上的性能。在功能方面，產品需滿足此份規格書中所定義的標準，尤其是 Section 3.2 and 3.3 中所註明的光學及電子方面的特性。產品需在測試後仍能達到驗收標準。

### 4.1 ACCEPTANCE CRITERIA [驗收標準]

After the reliability test, object must be fulfilled the function performance, especially on optical and electrical portion, which is mentioned on Section 3.3 and 3.4. Also the linearity deviation need to meet specified range:  $X \leq 1.5\%$ ,  $Y \leq 1.5\%$  and operating force  $\leq 250g$ .

經過信賴性測試後，產品應仍就能滿足光學及電子特性中所定義的規格(請參考 Section 3.3 and 3.4)；並且線性誤差值要滿足  $X \leq 1.5\%$ ,  $Y \leq 1.5\%$ 。其作動力需可以  $\leq 250g$ 。

### 4.2 RELIABILITY TEST [信賴性測試]

#### 4.2.1 HIGH TEMPERATURE & HUMIDITY [高溫高濕]

TEST ITEM [測試名稱]	HIGH TEMPERATURE & HUMIDITY TEST [高溫高濕]
ENVIRONMENT PARAMETER [測試參數]	60°C / 90%RH / 240 hrs [溫度 60°C / 濕度 90%RH/持續置入時間 240hrs]
TEST METHOD [測試方式]	Put DUT in test equipment under 240 hrs, then left panel to stand in room temperature, keep for 12 hrs [測試產品置入測試設備 240 小時後，回常溫靜置 12 小時後始可測試]

## 4.2.2 HIGH TEMPERATURE [高溫]

TEST ITEM [測試名稱]	HIGH TEMPERATURE TEST [高溫]
ENVIRONMENT PARAMETER [測試參數]	80°C /240 hrs [高溫 80°C / 持續置入時間 240 小時]
TEST METHOD [測試方式]	Put DUT in test equipment under 240 hrs, then left panel to stand in room temperature, keep for 12 hrs [測試產品置入測試設備 240 小時後，回常溫靜置 12 小時後始可測試]

## 4.2.3 LOW TEMPERATURE [低溫]

TEST ITEM [測試名稱]	LOW TEMPERATURE TEST [低溫]
ENVIRONMENT PARAMETER [測試參數]	-40°C /240 hrs [低溫 -40°C / 持續置入時間 240 小時]
TEST METHOD [測試方式]	Put DUT into test equipment under 240 hrs, then left panel to stand in room temperature, keep for 12 hrs [測試產品置入測試設備 240 小時後，回常溫靜置 12 小時後始可測試]

## 4.2.4 THERMAL CYCLING [冷熱循環]

TEST ITEM [測試名稱]	THERMAL CYCLING TEST [冷熱循環]
ENVIRONMENT PARAMETER [測試參數]	-40°C/30mins ~ 80°C/30mins Set 60mins/cycle [低溫-40°C ~ 高溫 80°C / 每小時一個循環]

TEST METHOD [測試方式]	Put DUT into test equipment under 50 cycles (50 hrs), then left panel to stand in room temperature, keep for 12 hrs [測試產品置入測試設備 50 個循環後 (50hrs) , 回常溫靜置 12 小時後始可測試]
-----------------------	--

#### 4.3 DURABILITY TOUCH TEST [耐久性觸摸測試]

TEST ITEM [測試名稱]	TOUCH TEST [觸摸測試]
PERFORMANCE CRITERIA [性能標準]	35,000,000 times [3500 萬次]

##### 4.3.1 TOUCH TEST METHOD [觸摸測試方式]

TEST EQUIPMENT [測試儀器]	Test Pen: R8.0 Silicon Rubber Hs60° 測試筆：R8.0 橡膠頭 Hs60°
TEST PROCEDURE [測試相關步驟]	Test Method: Contact the Rubber end-point with Active Area of operating surface 測試方式：接觸動作區
TEST CONDITION [測試條件]	Active Force: 250g 作動力: 250 公克 Contact Frequency: 3times/second 接觸頻率: 每秒 3 次 Total number of times: 35,000,000 times 總作動次數: 3500 萬次

OPERATION SCHEMATIC

[操作示意圖]

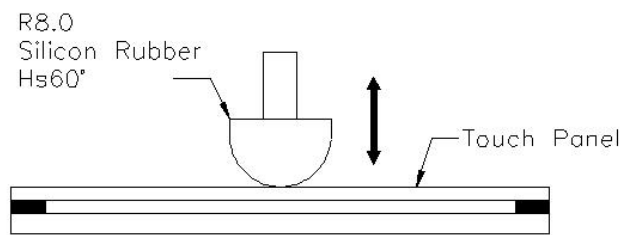



## 4.4 LINEARITY TEST [線性測試]

Inspecting products by linearity test to ensure linearity deviation under the determination of section 3.3.

用線性測試來驗證產品的線性功能符合第 3.3 章所定義的規範。

TEST ITEM [測試名稱]	LINEARITY TEST [線性測試]
TEST PROCEDURE [測試步驟]	Step 1: Short RT and RL (or short RL and LL) 步驟 1: 將 RT、RL 短路(或 RL、LL 短路)
	Step 2: Give 3.3V~5V DC 步驟 2: 接上 3.3V~5V 的直流電
	Step 3: Short LT and LL (or short RT and LT) 步驟 3: 將 LT、LL 短路(或 RT、LT 短路)
	Step 4: Give Grounding Conductor 0V 步驟 4: 連上接地線圈 0V
	Step 5: Draw the line follow Lx and Ly at 5.0mm equal interval by stylus, inside the active area 步驟 5: 以 5.0mm 的等間隔, 利用手寫筆沿著 Lx and Ly 在作動區之間畫出直線
	Step 6: Detect the voltage of the touch point 步驟 6: 測量該按壓點的電壓
	Step 7: Measure the voltage spread between RT and LT(or RT and RL) 步驟 7: 量測並計算 RT 與 LT 間的電位差(或 RT 與 RL 間的電位差)

<p>DETERMINE FUNDEMENTAL [計算原理]</p>	<p>Linearity: <math>[   V_{xm} - V_{xi}   ] / (V_a - V_b) \times 100\%</math></p>
---	---

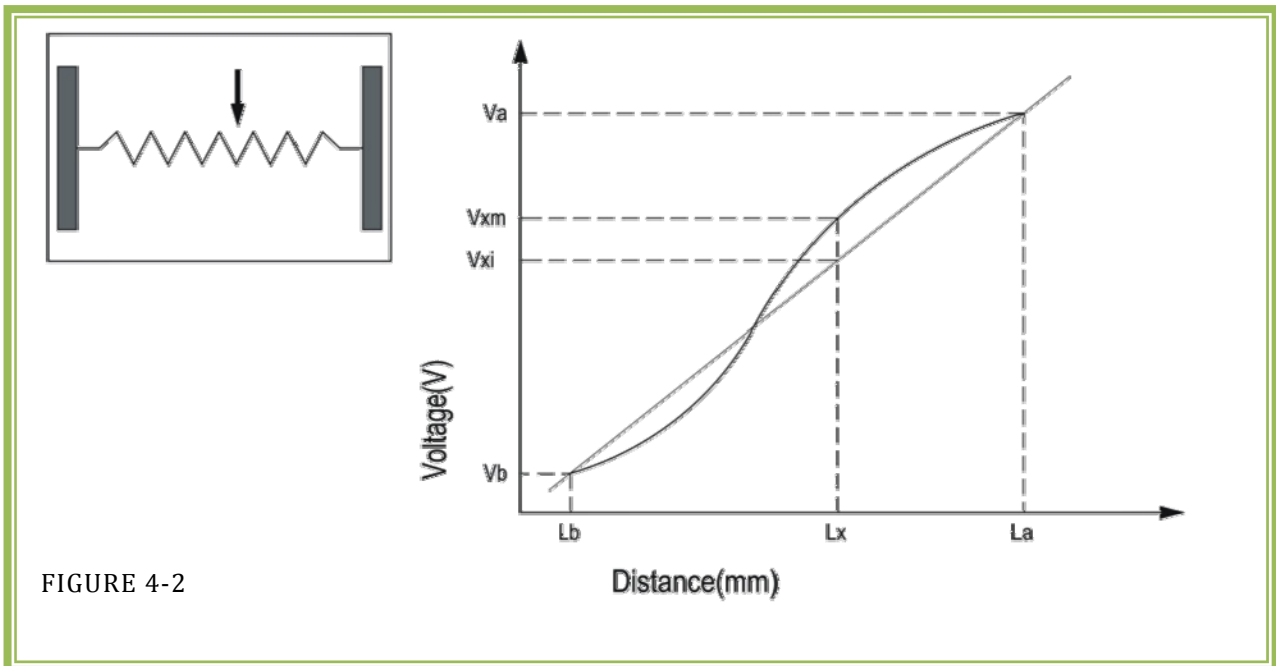
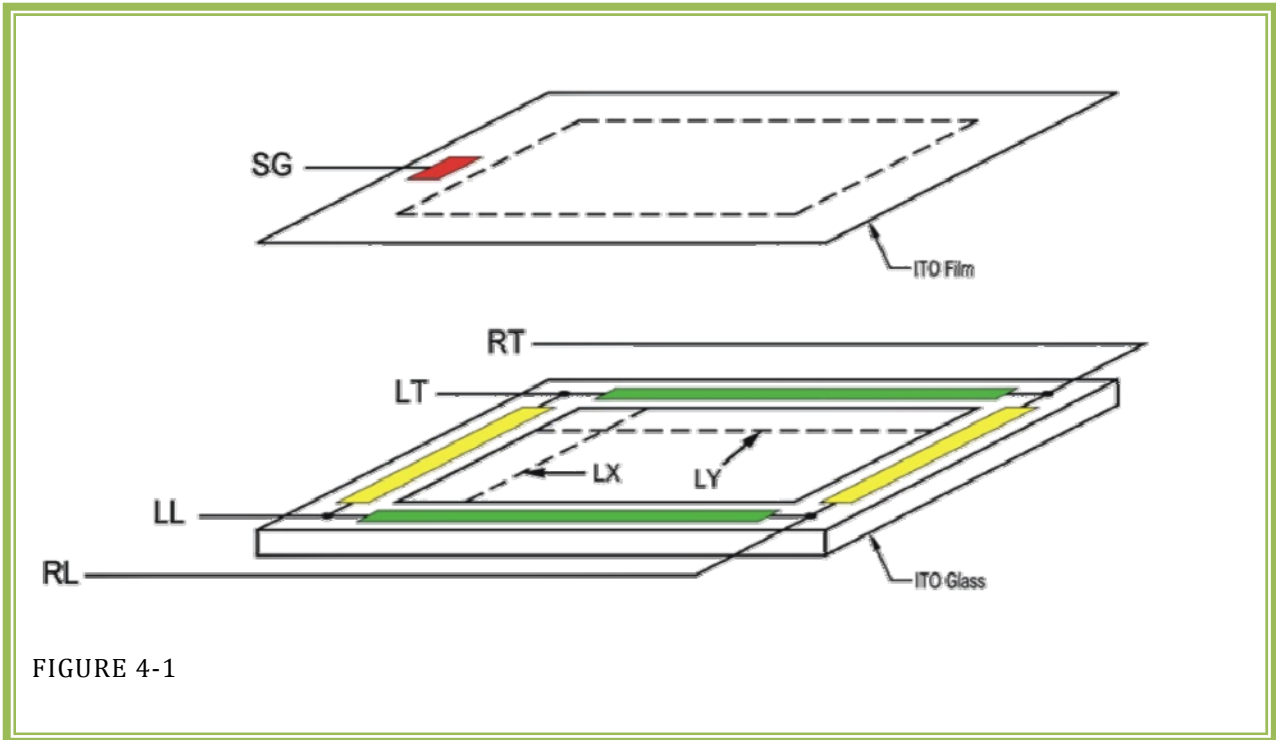

## 5. APPEARANCE SPECIFICATION [外觀規範]

### 5.1 DETECTION METHOD [檢驗方式]

DETECTED EQUIPMENT [檢測儀器/設備]	Incandescent lamps 白熾光燈	
LUMINOUS INTENSITY [光源強度]	600~1000 LUX	
DETECTION ANGLE [檢測角度]	Vertical Detection 垂直觀測	Tilt Detection 傾斜觀測
	90°	30°~60°
DETECTION METHOD [檢測方式]	Transmitted Light 穿透光	Reflection Light 反射光
VISUAL INSPECTION DISTANCE [目視檢測距離]	30 ± 5 cm	
DETECTION PERIOD [觀測時間]	30s	
QUANTITY [檢測數量]	Entire 全部	
DETECTED AREA [被觀測區域]	Inside of Viewable Area 可視區以內	
DEFECT IGNORED AREA [瑕疵可忽略區域]	Out of Viewable Area, and cannot impact function work 可視區以外，並且不能影響功能	
DETECTION PATH [觀測路徑]	'S' Way (Figure 5-3)	

OPERATING SCHEMATIC

[操作示意圖]

Figure 5-1 and 5-2

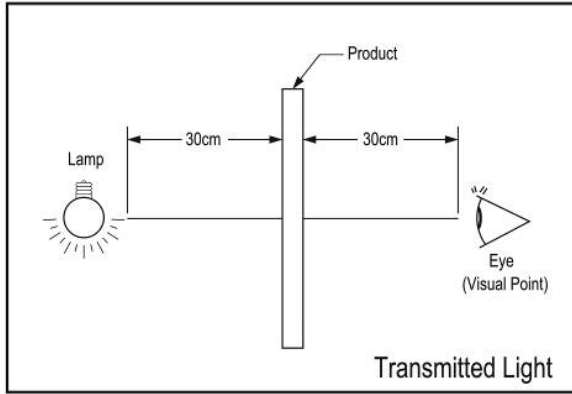

FIGURE 5-1

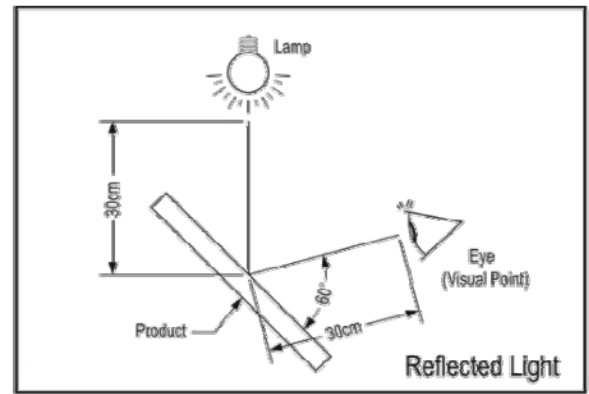

FIGURE 5-2

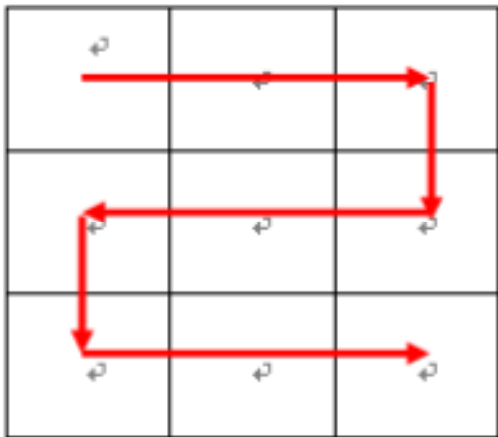

FIGURE 5-3 FRONT VIEW

## 5.2 DETECTION CRITERIA [外觀檢測標準]

### 5.2.1 DETERMINATION [定義]

(1) The [Section] is determined as below mentioned in Figure 5-4 .

定義[Section]，請參考 Figure 5-4。

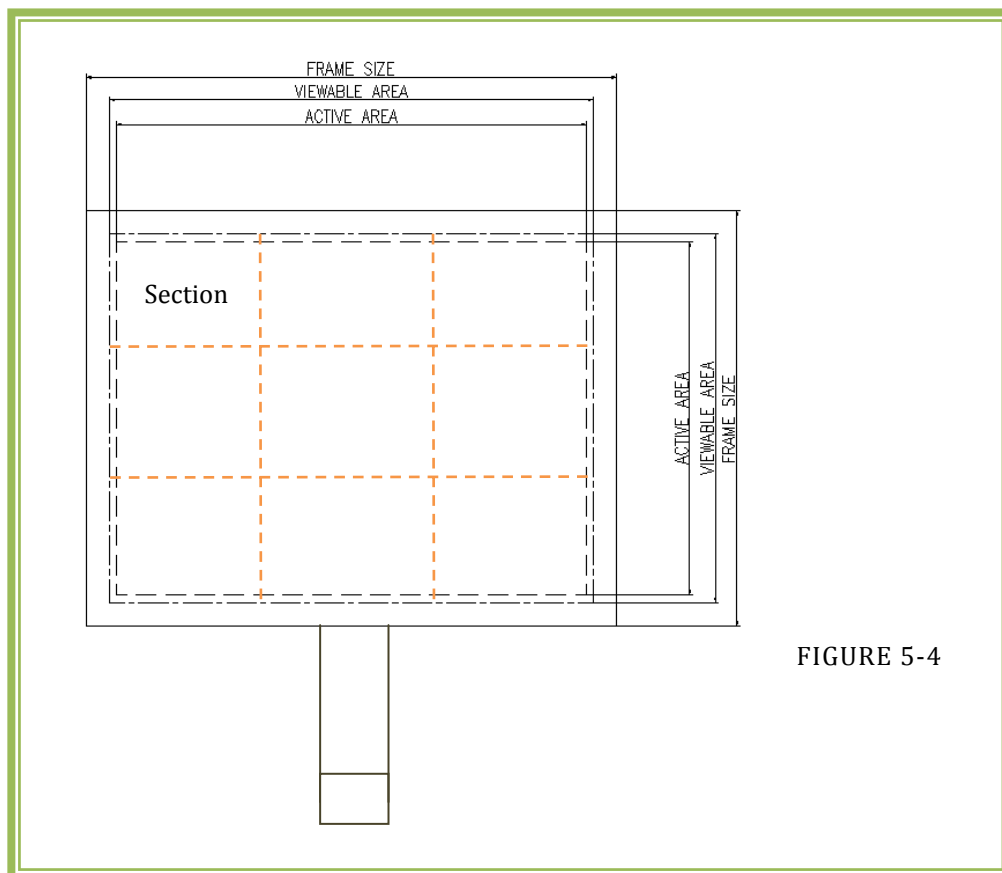
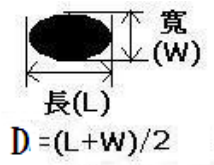
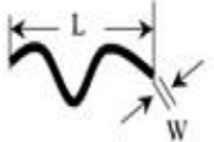

FIGURE 5-4

(2) Stain: mud, dirt or other material stick on surface area, can wipe off.

髒污: 輪廓不清晰，以肉眼辨識不易的沾污或與觸控面板表面有明顯色差，存在於觸控面板表面，可被擦拭乾淨。

5.2.2 CRITERIA AND DETERMINATION [標準及判定]

DEFECTS [瑕疵]	CRITERIA [檢測標準] (mm)	DETERMINATION [判定方式]	DIAGRAM [圖示]
Spot defect [點狀瑕疵]	$D \leq 0.3$	Ignore	
	$0.3 < D \leq 0.5$	Allow 1 Section $\leq 2$ and Total $\leq 5$	
	$D > 0.5$	NG	
Linear defect [線狀瑕疵]	$W \leq 0.05$	Ignore	
	$0.05 < W \leq 0.1$ and $L \leq 12$	Allow Total $\leq 3$ and Interval $> 20\text{mm}$	
	$W > 0.1$	NG	
Stain [髒污]	Wipe 3 times	If stain was off after maximum 3 times wiping, consider pass	

**Remark: if the stain could be cleaned within 3 times wrapping, then it could be ignored.**

注釋:如果可在三次擦拭後被清除的瑕疵，可認定不計

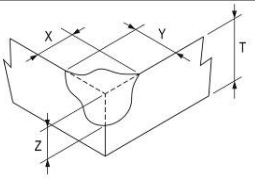
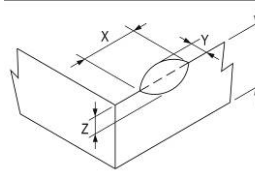
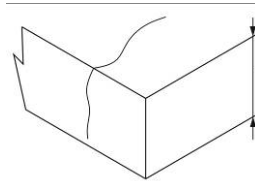
DEFECTS [瑕疵]	CRITERIA [檢測標準] (mm)	DETERMINATION [判定方式]	DIAGRAM [圖示]
Corner Chipping [崩角]	$X \leq 3.0\text{mm}$ $Y \leq 3.0\text{mm}$ $Z \leq T$	Allowable [允許]	
Edge Chipping [崩邊]	$X \leq 3.0\text{mm}$ $Y \leq 3.0\text{mm}$ $Z \leq T$	Allowable [允許]	
Crack [裂痕]	Unallowable [不允許]	Unallowable [不允許]	

## 6. ATTENTION [注意事項]

---

### 6.1 ON STORAGE [儲放]

---

#### 6.1.1 AFTER ASSEMBLY [組裝後]

---

#### **STORAGE CRITICAL ENVIRONMENT [儲放環境臨界值]:**

As mentioned in Section 3.1, the storage temperature and humidity is limited and defined as below:

3.1 章節敘述儲存時，產品所能耐受的溫度及濕度的最大極限：

- Storage Temperature [儲存溫度]: - 40°C ~ 80°C
- Maximum Storage Humidity [儲藏濕度]: 90%RH, maximum 50°C

---

***\*REMARK: BE CAUTION THAT THE STORAGE HUMIDITY DEFINED FOR SHORT DELIVERY WITH SPECIFIED PACKING ONLY.***

***\*備註：最大耐受濕度適用於短程運送，並且在指定的包裝規範下。***

---

#### 6.1.2 BEFORE ASSEMBLY [組裝前]

---

#### **STORAGE CONDITION [儲放條件]:**

Please keep in a cool and clean place at room temperature, and refer to the condition as below mentioned. Avoid direct sunshine and stacking placement after unpacking:

- Temperature 20~25°C
- Humidity  $\leq$ 65%RH

請儲放於通風乾淨的地方；並保持在室溫環境，並請參考下述條件；避免陽光直射；請勿在拆封後堆疊儲存。

- 溫度 20~25°C
- 濕度  $\leq$ 65%RH



## 6.2 INTEGRATED ASSEMBLY [組裝]

Please follow below note to assembly touch screen with LCD, and refer Figure 6-1 for the instruction.

組裝觸控屏幕及顯示螢幕時，請參考此章節的敘述，並以 Figure 6-1 的圖面做為參考。

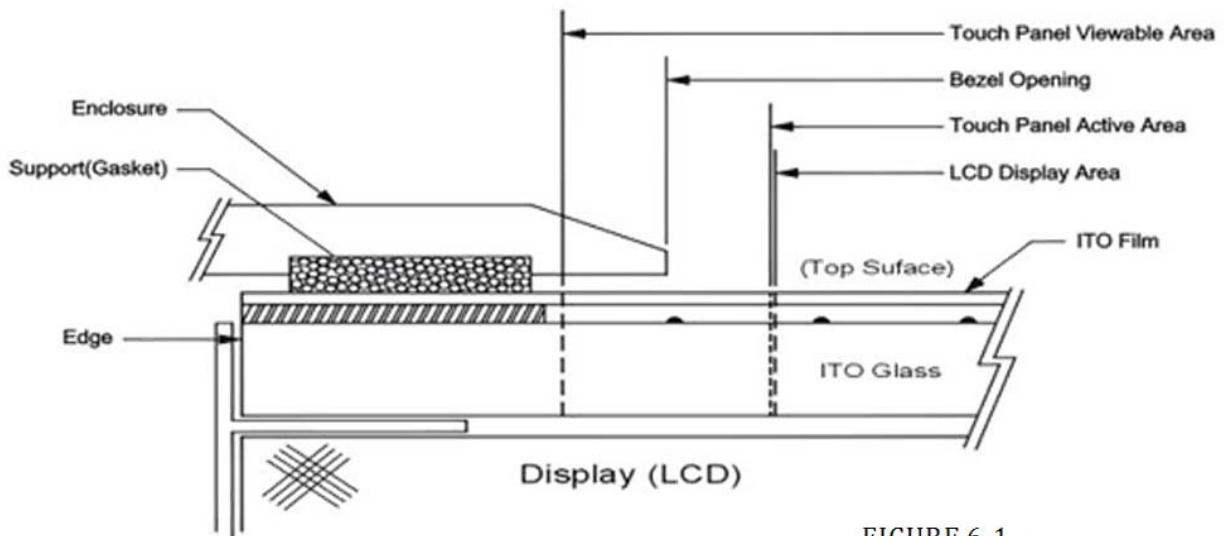

FIGURE 6-1

### 6.2.1 GASKET [前墊片]

- Gasket is required to be water and dust proof, also provide buffer space when touch screen squeezed.

在設計機構時，請務必設計前墊片，避免產品因為滲水或集塵造成的損傷，另外提供更多的空間在觸控屏幕被擠壓時給予緩衝。

- Please design the gasket outside of Viewable Area. And ensure that the touch screen View Area are not overlapped by the gasket.

請將墊片設計在可視區之外，並確認墊片不可蓋到觸控屏幕的可視區。

- Suggest using elastic material for gasket.

建議使用彈性材質的前墊片。

## 6.2.2 THE GAP BETWEEN BEZEL OPENING AND TOP SURFACE

### [前蓋框與觸控屏幕表面的空間]

- To avoid the issue of touch error or screen mis- pressed while assembled, please reserve at least 0.5 mm gap between front bezel and the surface of touch panel.

為避免誤動作或壓框發生，請最少預留 0.5mm 的空間於前蓋與觸控屏幕表面之間。

## 6.2.3 BEZEL OPENING [前蓋]

- For completed cover the touch screen, ABONTOUCH suggests that LCD Bezel Opening Area should be designed in between Touch Screen Viewable Area and Touch Screen Active Area.

為了可以完整的包覆觸控屏幕，我們建議應將機構的前蓋設計在可視區及動作區之間。

## 6.2.4 TAIL [連接線]

- To prevent tail damage, please do not pull the tail of product while carrying .

不可直接由 TAIL 端拉取產品，防止造成 TAIL 損傷或斷裂。

- Please Do Not bend the tail, as Figure 6-2

不可折傷 TAIL，如 Figure 6-2 所示

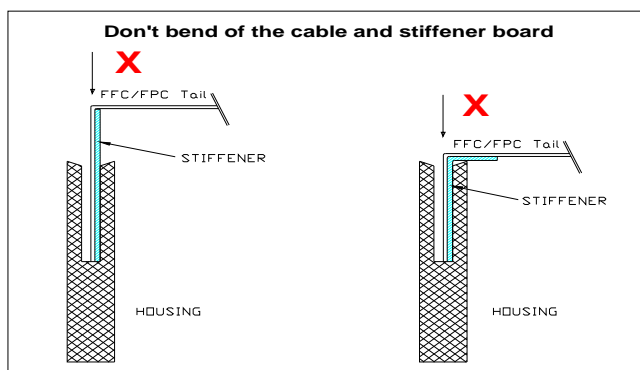

FIGURE 6-2

---

### 6.3 ON OPERATING [操作]

---

- Please avoid operating hard or sharp item on surface of product. It might cause failure of touch function and appearance scratch.

請避免用堅硬的銳物操作產品，因會損傷觸控屏幕表面，並造成功能喪失。

- Please keep products under stable environment and avoid any severe variation of temperature and humidity. Condensation on touch screen may cause product failure

請將面板放置在穩定的環境，應避免急遽的溫/濕度變化失效。凝結現象會造成面板功能不良。

- Any out of spec voltage/static electricity may cause danger and failure of product.

規格以外的高壓或靜電會造成產品嚴重損傷，必須避免。

- Grounding is needed for product.

請保持產品的控制器電源接地。

---

### 6.4 ON CLEANING [清潔]

---

- By using cleaning cloths with neutral detergent or alcohol to clean surface.

使用乾淨且柔軟的布，沾中性清潔劑或酒精進行清潔。

- Please do not use any of chemical solvent, acidic or alkali liquor for cleaning.

不能使用化學溶劑或酸鹼液進行清潔。

---

### 6.5 ON UNPACKING [拆裝]

---

- Please follow the instruction of specification while unpacking the product.

請按照外箱之標示拆裝產品。

---

### 6.6 CARRYING [搬運]

---

- Please be aware of the sharp edge of glass while carrying.

搬運時需留意玻璃邊緣，避免割傷。

## 7. LIMITED WARRANTY [有限保固]

---

This Limited Warranty includes part 1 Warranty Information and part 2 Warranty Exclusive.

本章節所描述的有限保固的內容包括 1. 保固內容及 2. 非保固範圍的敘述。

### 7.1 WARRANTY INFORMATION [保固內容]

---

TWO-Years limited Warranty is provided for this model and the Warranty Exclusions figured in Section 7.2.

有限保固二年，在 7.2 章有針對非保固範圍的定義。

### 7.2 WARRANTY EXCLUSIVE [非保固範圍]

---

This Limited Warranty does not extend to any Product that has been damaged or failures resulting by below situations:

如果產品在下述使用情況下，將不被列在保固範圍內：

- Carrier, connect or installer related.  
搬運及組裝過程中所造成的損傷及異常。
- Negligent and improper use, especially improper operate, misuse by end customer.  
不當使用，特別包括終端客戶的不當操作。
- Modifications or relocation.  
自行變更、維修、拆卸產品。
- Unusual physical or electrical stress or interference, failure or fluctuation of electrical power, temperature, or nature disaster.  
因非正常物理，電壓，干擾，溫度，天災等外在不可抗拒的因素。
- Undeclared or unexpected environmental conditions.  
在非正常環境特性下使用。

8. APPENDIX [附件]

● PACKAGING INFORMATION [包裝資訊]

1.

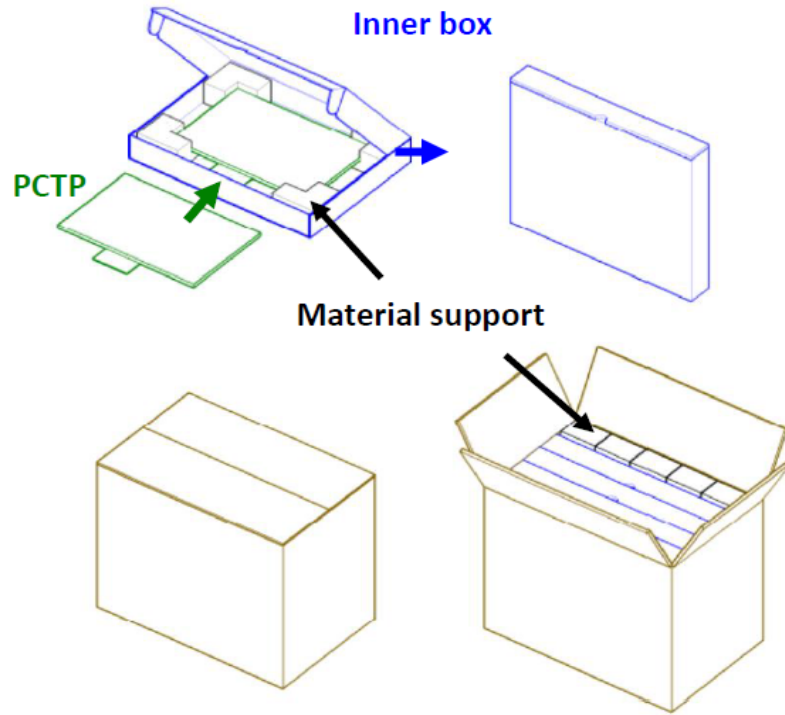

2.

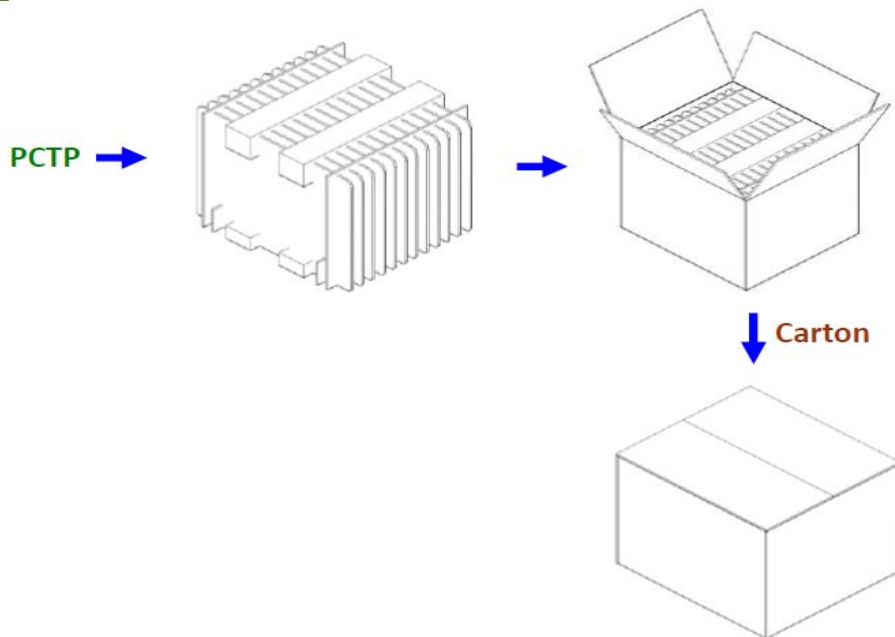

Figure 1 Package method

● Quantity and Size [數量和面板尺寸對應關係]

5-Wire Analog Resistive Touch Screen:

1.

PCTP	Inner box		Carton		
	TP QTY (pcs)	Inner box size (cm)	Inner box QTY (box)	Carton size (cm)	Total (pcs)
6/7	10	36*22*7	10	46*42*38	100
8/12	10/5	39*26.5*7	8	55*34*44	80/40
10.4	10	45*35*7	5	46.42*38	50
27	5	72.5*53*7.5	3	75*32.5*57	15

2.

PCTP	Carton	
	TP QTY (pcs)	Inner box size (cm)
15	20	50.3*42.4*36.4
17	20	50.3*42.4*36.4
18.5/19	20	58*42.5*38.5
20/24	10	71.5*26.5*43

Zero Bezel 5-Wire Resistive Touch Screen:

1.

PCTP	Inner box		Carton		
	TP QTY (pcs)	Inner box size (cm)	Inner box QTY (box)	Carton size (cm)	Total (pcs)
6/7	5	39*26.5*7	8	55*34*44	40
8/12	5	41*31*7	5	43.5*42*34	25
10.4	10	54*39*9	4	55*54*44	40

2.

PCTP	Carton	
	TP QTY (pcs)	Inner box size (cm)
15	20	50.3*42.4*36.4
17	20	58*42.5*38.5
18.5/19	10	71.5*26.5*43

- **Shipping Number [出貨編號]**

Paste Site [黏貼處] : FPC/FFC

Explain[定義]

: 12-1-123456



Our company network supports you worldwide with offices in Germany, Austria, Switzerland, the UK and the USA.  
For more information please contact:

## Headquarters

Germany



**FORTEC**  
GROUP

FORTEC Elektronik AG  
Augsburger Str. 2b  
82110 Germering

Phone: +49 89 894450-0  
E-Mail: [info@fortecag.de](mailto:info@fortecag.de)  
Internet: [www.fortecag.de](http://www.fortecag.de)

---

## Fortec Group Members

Austria



**FORTEC**  
INTEGRATED

FORTEC Integrated GmbH Office Vienna  
Nuschinggasse 12  
1230 Wien

Phone: +43 1 8673492-0  
E-Mail: [info@fortec-integrated.de](mailto:info@fortec-integrated.de)  
Internet: [www.fortec-integrated.de](http://www.fortec-integrated.de)

Germany



**FORTEC**  
INTEGRATED

FORTEC Integrated GmbH  
Augsburger Str. 2b  
82110 Germering

Phone: +49 89 894363-0  
E-Mail: [info@fortec-integrated.de](mailto:info@fortec-integrated.de)  
Internet: [www.fortec-integrated.de](http://www.fortec-integrated.de)

Switzerland



**FORTEC**  
SWITZERLAND

FORTEC Switzerland AG  
Bahnhofstraße 3  
5436 Würenlos

Phone: +41 44 7446111  
E-Mail: [info@fortec.ch](mailto:info@fortec.ch)  
Internet: [www.fortec.ch](http://www.fortec.ch)

United Kingdom



**FORTEC**  
UNITED KINGDOM

FORTEC Technology UK Ltd.  
Osprey House, 1 Osprey Court  
Hinchingbrooke Business Park  
Huntingdon, Cambridgeshire, PE29 6FN

Phone: +44 1480 411600  
E-Mail: [info@fortec.uk](mailto:info@fortec.uk)  
Internet: [www.fortec.uk](http://www.fortec.uk)

USA



**FORTEC**  
UNITED STATES

FORTEC US, Corp.  
87 Raynor Avenue, Unit 1  
Ronkonkoma, NY 11779

Phone: +1 631 5804360  
E-Mail: [info@fortec.us](mailto:info@fortec.us)  
Internet: [www.fortec.us](http://www.fortec.us)